

Updated 05/15/2020

FEDERAL PROJECT

BIDDING INSTRUCTIONS

FOR ALL PROJECTS:

1. Use pen and ink to complete all paper Bids.
2. As a minimum, the following must be received prior to the time of Bid opening:

For a Paper Bid:

- a) a copy of the Notice to Contractors, b) the completed Acknowledgement of Bid Amendments form, c) the completed Schedule of Items, d) two copies of the completed and signed Contract Offer, Agreement & Award form, e) a Bid Guaranty, (if required), and f) any other certifications or Bid requirements listed in the Bid Documents as due by Bid opening.

For an Electronic Bid:

NOTE: Not all projects accept Electronic Bids. Please review the Notice to Contractors and see if it specifically states that Electronic Bids will be accepted.

- a) a completed Bid using Expedite® software and submitted via the Bid Express™ web-based service, b) an electronic Bid Guaranty (if required) or a faxed copy of a Bid Bond (with original to be delivered within 72 hours), and c) any other Certifications or Bid requirements listed in the Bid Documents as due by Bid opening.
3. Include prices for all items in the Schedule of Items (excluding non-selected alternates).
4. Bid Guaranty acceptable forms are:
 - a) a properly completed and signed Bid Bond on the Department's prescribed form (or on a form that does not contain any significant variations from the Department's form as determined by the Department) for 5% of the Bid Amount or
 - b) an Official Bank Check, Cashier's Check, Certified Check, U.S. Postal Money Order or Negotiable Certificate of Deposit in the amount stated in the Notice to Contractors or
 - c) an electronic bid bond submitted with an electronic bid.
5. If a paper Bid is to be sent, "FedEx First Overnight" delivery is suggested as the package is delivered directly to the DOT Headquarters Building located at 16 Child Street in Augusta. Other means, such as U.S. Postal Service's Express Mail has proven not to be reliable.

IN ADDITION, FOR FEDERAL AID PROJECTS:

6. Complete the DBE Proposed Utilization form, and submit with your bid. If you are submitting your bid electronically, you must FAX the form to (207) 624-3431. This is a curable defect.

*If you need further information regarding Bid preparation, call the DOT
Contracts Section at (207) 624-3410.*

*For complete bidding requirements, refer to Section 102 of the Maine Department
of Transportation, Standard Specifications, March 2020 Edition.*

NOTICE

The Maine Department of Transportation is attempting to improve the way Bid Amendments/Addendums are handled and allow for an electronic downloading of bid packages from our website, while continuing to maintain an optional plan holders list.

Prospective bidders, subcontractors or suppliers who wish to download a copy of the bid package and receive a courtesy notification of project specific bid amendments must fill out the on-line plan holder registration form and provide an email address to the MDOT Contracts mailbox at: MDOT.contracts@maine.gov. Each bid package will require a separate request.

Additionally, interested parties will be responsible for reviewing and retrieving the Bid Amendments from our web site, and acknowledging receipt and incorporating those Bid Amendments in their bids using the Acknowledgement of Bid Amendment Form.

The downloading of bid packages from the MDOT website is not the same as providing an electronic bid to the Department. Electronic bids must be submitted via <http://www.BIDX.com>. For information on electronic bidding contact Rebecca Snowden at rebecca.snowden@maine.gov or Diane Barnes at diane.barnes@maine.gov.

NOTICE

For security and other reasons, all Bid Packages which are mailed, shall be provided in double (one envelope inside the other) envelopes. The *Inner Envelope* shall have the following information provided on it:

Bid Enclosed - Do Not Open

PIN:

Town:

Date of Bid Opening:

Name of Contractor with mailing address and telephone number:

In Addition to the usual address information, the *Outer Envelope* should have written or typed on it:

Double Envelope: Bid Enclosed

PIN:

Town:

Date of Bid Opening:

Name of Contractor:

This should not be much of a change for those of you who use Federal Express or similar services.

Hand-carried Bids may be in one envelope as before, and should be marked with the following information:

Bid Enclosed: Do Not Open

PIN:

Town:

Name of Contractor:

October 16, 2001

STATE OF MAINE DEPARTMENT OF TRANSPORTATION
Bid Guaranty-Bid Bond Form

KNOW ALL MEN BY THESE PRESENTS THAT _____

_____, of the City/Town of _____ and State of _____

as Principal, and _____ as Surety, a

Corporation duly organized under the laws of the State of _____ and having a usual place of

Business in _____ and hereby held and firmly bound unto the Treasurer of

the State of Maine in the sum of _____ for payment which Principal and Surety bind

themselves, their heirs, executors, administrators, successors and assigns, jointly and severally.

The condition of this obligation is that the Principal has submitted to the Maine Department of

Transportation, hereafter Department, a certain bid, attached hereto and incorporated as a

part herein, to enter into a written contract for the construction of _____

_____ and if the Department shall accept said bid

and the Principal shall execute and deliver a contract in the form attached hereto (properly

completed in accordance with said bid) and shall furnish bonds for this faithful performance of

said contract, and for the payment of all persons performing labor or furnishing material in

connection therewith, and shall in all other respects perform the agreement created by the

acceptance of said bid, then this obligation shall be null and void; otherwise it shall remain in full

force, and effect.

Signed and sealed this _____ day of _____ 20_____

WITNESS:

WITNESS

PRINCIPAL:

By _____

By: _____

By: _____

SURETY:

By _____

By: _____

Name of Local Agency: _____

NOTICE

Bidders:

Please use the attached “Request for Information” form when submitting questions concerning specific Contracts that have been advertised for Bid, include additional numbered pages as required. RFI’s may be faxed to 207-624-3431, submitted electronically through the Departments web page of advertised projects by selecting the RFI tab on the project details page or via e-mail to RFI-Contracts.MDOT@maine.gov.

These are the only allowable mechanisms for answering Project specific questions. Maine DOT will not be bound to any answers to Project specific questions received during the Bidding phase through other processes.

When submitting RFIs by Email please follow the same guidelines as stated on the “Request for Information” form and include the word “RFI” along with the Project name and Identification number in the subject line.

NOTICE

Disadvantaged Business Enterprise Proposed Utilization

The Apparent Low Bidder shall submit the Disadvantaged Business Enterprise Proposed Utilization form with their bid. This is a curable bid defect.

The Contractor's Disadvantaged Business Enterprise Proposed Utilization Plan form contains additional information that is required by USDOT.

The Contractor's Disadvantaged Business Enterprise Proposed Utilization Plan form should be used.

A copy of the new Contractor's Disadvantaged Business Enterprise Proposed Utilization Plan and instructions for completing it are attached.

Note: Questions about DBE firms, or to obtain a printed copy of the DBE Directory, contact The Office of Civil Rights at (207) 624-3066.

MDOT's DBE Directory of Certified firms can also be obtained at <https://www.maine.gov/mdot/civilrights/dbe/>

INSTRUCTIONS FOR PREPARING THE MaineDOT CONTRACTOR'S DBE/SUBCONTRACTOR UTILIZATION FORM

The Contractor Shall Extend equal opportunity to MaineDOT certified DBE firms (as listed in MaineDOT's DBE Directory of Certified Businesses) in the selection and utilization of Subcontractors and Suppliers.

SPECIFIC INSTRUCTIONS FOR COMPLETING THE FORM:

Insert Contractor name, the name of the person(s) preparing the form, and that person(s) telephone, fax number and e-mail address.

Calculate and provide percentage of your bid that will be allocated to DBE firms, Federal Project Identification Number, and location of the Project work.

In the columns, name each subcontractor, DBE and non-DBE firm to be used, provide the Unit/Item cost of the work/product to be provided by the subcontractor, give a brief description and the dollar value of the work.

Revised 1/12

DBE GOAL NOTICE FFY 2019-2021
Maine Department of Transportation
Disadvantaged Business Enterprise Program

Notice is hereby given that in accordance with US DOT regulation 49 CFR Part 26, the Maine Department of Transportation (MaineDOT) has established a Disadvantaged Business Enterprise Program (DBE) for disadvantaged business participation in the federal-aid highway and bridge construction programs; MaineDOT contracts covered by the program include consulting, construction, supplies, manufacturing, and service contracts.

For FFY 2019-21 (October 1, 2018 through September 30, 2021) MaineDOT has established an annual DBE participation goal of **2.4%** to be achieved through race/gender neutral means. This goal has been approved by the Federal Highway Administration and remains in effect through September 30, 2021. Maine DOT must meet this goal each federal fiscal year. If the goal is not met, MaineDOT must provide a justification for not meeting the goal and provide a plan to ensure the goal is met, which may include placing contract goals on certain projects that contractors will be required to meet.

MaineDOT asks all contractors, consultants and subcontractors to seek certified DBE firms for projects and to work to meet the determined 2.4% goal without the need to impose contract goals. DBE firms are listed on the MaineDOT website at:

<https://www.maine.gov/mdot/civilrights/docs/dbe/WeeklyDBEVendorList.pdf>

Interested parties may view MaineDOT's DBE goal setting methodology, also posted on this website. If you have questions regarding this goal or the DBE program you may contact Sherry Tompkins at the Maine Department of Transportation, Civil Rights Office by telephone at (207) 624-3066 or by e-mail at: sherry.tompkins@maine.gov

**MaineDOT CONTRACTOR'S DBE/SUBCONTRACTOR
PROPOSED UTILIZATION FORM**

All Bidders must furnish this form with their bid on Bid Opening day

Contractor: _____ Telephone: _____ Ext _____

Contact Person: _____ Fax: _____

E-mail: _____

BID DATE: _____

FEDERAL PROJECT PIN # _____ PROJECT LOCATION: _____

TOTAL ANTICIPATED DBE _____% PARTICIPATION FOR THIS CONTRACT

W B E	D B E	Non DBE	Firm Name	Item Number & Description of Work	Quantity	Cost Per Unit/Item	Anticipated \$ Value
Subcontractor Total >							
DBE Total >							

NOTE: THIS INFORMATION IS USED TO TRACK AND REPORT ANTICIPATED DBE PARTICIPATION IN ALL FEDERALLY FUNDED MAINE DOT CONTRACTS. THE ANTICIPATED DBE AMOUNT IS VOLUNTARY AND WILL NOT BECOME A PART OF THE CONTRACTUAL TERMS.

Equal Opportunity Use:

Form received: ___/___/___ Verified by: _____

FHWA FTA FAA

**For a complete list of certified firms and company designation (WBE/DBE) go to
<http://www.maine.gov/mdot/civilrights/>**

Maine Department of Transportation Civil Rights Office

Directory of Certified Disadvantaged Business Enterprises

Listing can be found at:

<https://www.maine.gov/mdot/civilrights/dbe/>

For additional information and guidance contact:

Civil Rights Office at (207) 624-3066

It is the responsibility of the Contractor to access the DBE Directory at this site in order to have the most current listing.

Vendor Registration

Prospective Bidders must register as a vendor with the Department of Administrative & Financial Services if the vendor is awarded a contract. Vendors will not be able to receive payment without first being registered. Vendors/Contractors will find information and register through the following link –

<http://www.maine.gov/purchases/venbid/index.shtml>

**STATE OF MAINE DEPARTMENT OF TRANSPORTATION
NOTICE TO CONTRACTORS**

Sealed Bids addressed to the Maine Department of Transportation, Augusta, Maine 04333 and endorsed on the wrapper "Bids for Pavement Milling and Ultra-Thin Bonded Wearing Course in the City of Caribou and Towns Woodland, & New Sweden" will be received from contractors at the Reception Desk, MaineDOT Building, Capitol Street, Augusta, Maine, until 11:00 o'clock A.M. (prevailing time) on April 7, 2021 and at that time and place, publicly opened and read. Bids will be accepted from all bidders. The lowest responsive bidder must have completed, or successfully complete, a Highway Construction, Paving, or project specific prequalification to be considered for the award of this contract. **We now accept electronic bids for bid packages posted on the bidx.com website. Electronic bids do not have to be accompanied by paper bids. Please note: The Department will accept a facsimile of the bid bond; however, the original bid bond must then be received at the MDOT Contract Section within 72 hours of the bid opening.** Until further notice, dual bids (one paper, one electronic) will be accepted, with the paper copy taking precedence.

Description: Maine Federal Aid Project No. 2492300 WIN 24923.00

Location: In Aroostook County, project is located on Route 161 beginning in Caribou at the south junction of US Route 1 and extending northwest 9.80 miles to 0.08 of a mile southeast of the Station Road.

Outline of Work: Pavement Milling, and Ultra-Thin Bonded Wearing Course, and other incidental work.

For general information regarding Bidding and Contracting procedures, contact George Macdougall at (207) 624-3410. Our webpage at <http://www.maine.gov/mdot/contractors/> contains a copy of the Schedule of Items, Plan Holders List, written portions of bid amendments, drawings, bid results and an electronic form for RFI submittal. For Project-specific information fax all questions to **George MacDougall** at (207) 624-3431, use electronic RFI form or email questions to RFI-Contracts.MDOT@maine.gov, project name and identification number should be in the subject line. Questions received after 12:00 noon of Monday (or if that Monday is a state holiday, Friday) prior to bid date will not be answered. Bidders shall not contact any other Departmental staff for clarification of Contract provisions, and the Department will not be responsible for any interpretations so obtained. TTY users call Maine Relay 711.

Specifications and bid forms may be seen at the MaineDOT Building in Augusta, Maine, and at the Department of Transportation's Regional Office in Presque Isle. They may be purchased from the Department between the hours of 8:00 a.m. to 4:30 p.m. by cash, credit card (Visa/Mastercard) or check payable to Treasurer, State of Maine sent to Maine Department of Transportation, Attn.: Mailroom, 16 State House Station, Augusta, Maine 04333-0016. They also may be purchased by telephone at (207) 624-3536 between the hours of 8:00 a.m. to 4:30 p.m. Bid Book \$10 (\$13 by mail), payment in advance, all non-refundable.

Each Bid must be made upon blank forms provided by the Department and must be accompanied by a bid bond at 5% of the bid amount or an official bank check, cashier's check, certified check, certificate of deposit, or United States postal money order in the amount of **\$70,000** payable to Treasurer, State of Maine as a Bid guarantee. A Contract Performance Surety Bond and a Contract Payment Surety Bond, each in the amount of 100 percent of the Contract price, will be required of the successful Bidder.

This Contract is subject to all applicable Federal Laws. This contract is subject to compliance with the Disadvantaged Business Enterprise program requirements as set forth by the Maine Department of Transportation.

All work shall be governed by *State of Maine, Department of Transportation, Standard Specifications, March 2020 Edition*, price \$10 [\$15 by mail], and *Standard Details, March 2020 Edition*, price \$10 [\$15 by mail]. They also may be purchased by telephone at (207) 624-3536 between the hours of 8:00 a.m. to 4:30 p.m. *Standard Detail* updates can be found at <http://www.maine.gov/mdot/contractors/publications/>.

The right is hereby reserved to the MaineDOT to reject any or all bids.

Augusta, Maine
March 17, 2021

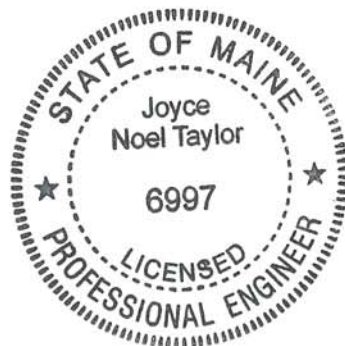

JOYCE NOEL TAYLOR P. E.
CHIEF ENGINEER

NOTICE

All bids for Federal Projects **shall** be accompanied by the DBE Proposed Utilization form. If you are submitting an electronic bid, the DBE Utilization Form may be faxed to 207-624-3431. Failure to submit the form with the bid will be considered a curable defect.

Maine Department of Transportation

Proposal Schedule of Items

Proposal ID: 024923.00

Project(s): 024923.00

SECTION: 1 Highway Items

Alt Set ID: Alt Mbr ID:

Contractor: _____

Proposal Line Number	Item ID Description	Approximate Quantity and Units	Unit Price		Bid Amount	
			Dollars	Cents	Dollars	Cents
0010	202.2023 REMOVING PAVEMENT SURFACE - MEDIUM CUT DRUM	154,570.000 SY	_____	 _____	_____	 _____
0020	403.211 HOT MIX ASPHALT (SHIMMING)	100.000 T	_____	 _____	_____	 _____
0030	409.15 BITUMINOUS TACK COAT - APPLIED	60.000 G	_____	 _____	_____	 _____
0040	410.151 EMULSIFIED ASPHALT SEALCOAT, APPLIED	27,700.000 SY	_____	 _____	_____	 _____
0050	410.161 COVER COAT MATERIAL, SAND	1,096.000 LB	_____	 _____	_____	 _____
0060	424.22 ASPHALT RUBBER CRACK SEALER TYPE 2, APPLIED	36,590.000 LB	_____	 _____	_____	 _____
0070	462.301 POLYMER MODIFIED ULTRATHIN BONDED WEARING COURSE	154,570.000 SY	_____	 _____	_____	 _____
0080	627.733 4" WHITE OR YELLOW PAINTED PAVEMENT MARKING LINE	165,180.000 LF	_____	 _____	_____	 _____
0090	627.75 WHITE OR YELLOW PAVEMENT & CURB MARKING	260.000 SF	_____	 _____	_____	 _____
0100	627.78 TEMPORARY 4 INCH PAINTED PAVEMENT MARKING LINE, WHITE OR YELLOW	330,360.000 LF	_____	 _____	_____	 _____
0110	631.12 ALL PURPOSE EXCAVATOR (INCLUDING OPERATOR)	20.000 HR	_____	 _____	_____	 _____

Maine Department of Transportation

Proposal Schedule of Items

Proposal ID: 024923.00

Project(s): 024923.00

SECTION: 1 Highway Items

Alt Set ID: Alt Mbr ID:

Contractor: _____

Proposal Line Number	Item ID Description	Approximate Quantity and Units	Unit Price		Bid Amount	
			Dollars	Cents	Dollars	Cents
0120	631.172 TRUCK - LARGE (INCLUDING OPERATOR)	40.000 HR	_____	 _____	_____	 _____
0130	639.19 FIELD OFFICE TYPE B	1.000 EA	_____	 _____	_____	 _____
0140	652.33 DRUM	10.000 EA	_____	 _____	_____	 _____
0150	652.34 CONE	100.000 EA	_____	 _____	_____	 _____
0160	652.35 CONSTRUCTION SIGNS	730.000 SF	_____	 _____	_____	 _____
0170	652.36 MAINTENANCE OF TRAFFIC CONTROL DEVICES	56.000 CD	_____	 _____	_____	 _____
0180	652.38 FLAGGER	940.000 HR	_____	 _____	_____	 _____
0190	656.75 TEMPORARY SOIL EROSION AND WATER POLLUTION CONTROL	LUMP SUM		 LUMP SUM	_____	 _____
0200	659.10 MOBILIZATION	LUMP SUM		 LUMP SUM	_____	 _____
Section: 1			Total:		_____	 _____
			Total Bid:		_____	 _____

CONTRACT AGREEMENT, OFFER & AWARD

AGREEMENT made on the date last signed below, by and between the State of Maine, acting through and by its Department of Transportation (Department), an agency of state government with its principal administrative offices located at Child Street, Augusta, Maine, with a mailing address at 16 State House Station, Augusta, Maine 04333-0016, and _____ a corporation or other legal entity organized under the laws of the State of _____, with its principal place of business located at _____

The Department and the Contractor, in consideration of the mutual promises set forth in this Agreement (the “Contract”), hereby agree as follows:

A. **The Work.**

The Contractor agrees to complete all Work as specified or indicated in the Contract including Extra Work in conformity with the Contract, **WIN 24923.00 for Pavement Milling and Ultra-Thin Bonded Wearing Course in the City of Caribou and Towns of Woodland & New Sweden, County of Aroostook, Maine.** The Work includes construction, maintenance during construction, warranty as provided in the Contract, and other incidental work.

The Contractor shall be responsible for furnishing all supervision, labor, equipment, tools supplies, permanent materials and temporary materials required to perform the Work including construction quality control including inspection, testing and documentation, all required documentation at the conclusion of the project, warranting its work and performing all other work indicated in the Contract.

The Department shall have the right to alter the nature and extent of the Work as provided in the Contract; payment to be made as provided in the same.

B. **Time.**

The Contractor agrees to complete all Work, except warranty work, within **35** Working Days. Further, the Department may deduct from moneys otherwise due the Contractor, not as a penalty, but as Liquidated Damages in accordance with Sections 107.7 and 107.8 of the *State of Maine Department of Transportation Standard Specifications, March 2020 Edition* and related Special Provisions.

C. Price.

The quantities given in the Schedule of Items of the Bid Package will be used as the basis for determining the original Contract amount and for determining the amounts of the required Performance Surety Bond and Payment Surety Bond, and that the amount of this offer is _____

_____ \$ _____ Performance Bond and Payment Bond each being 100% of the amount of this Contract.

D. Contract.

This Contract, which may be amended, modified, or supplemented in writing only, consists of the Contract documents as defined in the Plans, *Standard Specifications, March 2020 Edition, Standard Details March 2020 Edition* as updated through advertisement, Supplemental Specifications, Special Provisions, Contract Agreement; and Contract Bonds. It is agreed and understood that this Contract will be governed by the documents listed above.

E. Certifications.

By signing below, the Contractor hereby certifies that to the best of the Contractor's knowledge and belief:

1. All of the statements, representations, covenants, and/or certifications required or set forth in the Bid and the Bid Documents, including those in the Federal Contract Provisions Supplement, and the Contract are still complete and accurate as of the date of this Agreement.
2. The Contractor knows of no legal, contractual, or financial impediment to entering into this Contract.
3. The person signing below is legally authorized by the Contractor to sign this Contract on behalf of the Contractor and to legally bind the Contractor to the terms of the Contract.

F. Offer.

The undersigned, having carefully examined the site of work, the Plans, *Standard Specifications March 2020 Edition*, *Standard Details March 2020 Edition* as updated through advertisement, Supplemental Specifications, Special Provisions, Contract Agreement; and Contract Bonds contained herein for construction of: **WIN 24923.00 for Pavement Milling and Ultra-Thin Bonded Wearing Course in the City of Caribou and Towns of Woodland & New Sweden, County of Aroostook,** State of Maine, on which bids will be received until the time specified in the “Notice to Contractors” do(es) hereby bid and offer to enter into this contract to supply all the materials, tools, equipment and labor to construct the whole of the Work in strict accordance with the terms and conditions of this Contract at the unit prices in the attached “Schedule of Items.”

The Offeror agrees to perform the work required at the price specified above and in accordance with the bids provided in the attached “Schedule of Items” in strict accordance with the terms of this solicitation, and to provide the appropriate insurance and bonds if this offer is accepted by the Government in writing.

As Offeror also agrees:

First: To do any extra work, not covered by the attached “Schedule of Items,” which may be ordered by the Resident, and to accept as full compensation the amount determined upon a “Force Account” basis as provided in the *Standard Specifications, March 2020 Edition*, and as addressed in the contract documents.

Second: That the bid bond at 5% of the bid amount or the official bank check, cashier’s check, certificate of deposit or U. S. Postal Money Order in the amount given in the “Notice to Contractors”, payable to the Treasurer of the State of Maine and accompanying this bid, shall be forfeited, as liquidated damages, if in case this bid is accepted, and the undersigned shall fail to abide by the terms and conditions of the offer and fail to furnish satisfactory insurance and Contract bonds under the conditions stipulated in the Specifications within 15 days of notice of intent to award the contract.

Third: To begin the Work as stated in Section 107.2 of the *Standard Specifications March 2020 Edition* and complete the Work within the time limits given in the Special Provisions of this Contract.

Fourth: The Contractor will be bound to the Disadvantaged Business Enterprise (DBE) Requirements contained in the attached Notice (Additional Instructions to Bidders) and submit a completed Contractor’s Disadvantaged Business Enterprise Utilization Plan with their bid.

Fifth: That this offer shall remain open for 30 calendar days after the date of opening of bids.

Sixth: The Bidder hereby certifies, to the best of its knowledge and belief that: the Bidder has not, either directly or indirectly, entered into any agreement, participated in any collusion, or otherwise taken any action in restraint of competitive bidding in connection with its bid, and its subsequent contract with the Department.

IN WITNESS WHEREOF, the Contractor, for itself, its successors and assigns, hereby execute two duplicate originals of this Agreement and thereby binds itself to all covenants, terms, and obligations contained in the Contract Documents.

CONTRACTOR

Date

(Signature of Legally Authorized Representative
of the Contractor)

Witness

(Name and Title Printed)

G. Award.

Your offer is hereby accepted.
documents referenced herein.

This award consummates the Contract, and the

MAINE DEPARTMENT OF TRANSPORTATION

Date

By: Bruce A. Van Note, Commissioner

Witness

CONTRACT AGREEMENT, OFFER & AWARD

AGREEMENT made on the date last signed below, by and between the State of Maine, acting through and by its Department of Transportation (Department), an agency of state government with its principal administrative offices located at Child Street, Augusta, Maine, with a mailing address at 16 State House Station, Augusta, Maine 04333-0016, and _____ a corporation or other legal entity organized under the laws of the State of _____, with its principal place of business located at _____

The Department and the Contractor, in consideration of the mutual promises set forth in this Agreement (the “Contract”), hereby agree as follows:

A. **The Work.**

The Contractor agrees to complete all Work as specified or indicated in the Contract including Extra Work in conformity with the Contract, **WIN 24923.00 for Pavement Milling and Ultra-Thin Bonded Wearing Course in the City of Caribou and Towns of Woodland & New Sweden, County of Aroostook, Maine.** The Work includes construction, maintenance during construction, warranty as provided in the Contract, and other incidental work.

The Contractor shall be responsible for furnishing all supervision, labor, equipment, tools supplies, permanent materials and temporary materials required to perform the Work including construction quality control including inspection, testing and documentation, all required documentation at the conclusion of the project, warranting its work and performing all other work indicated in the Contract.

The Department shall have the right to alter the nature and extent of the Work as provided in the Contract; payment to be made as provided in the same.

B. **Time.**

The Contractor agrees to complete all Work, except warranty work, within **35** Working Days. Further, the Department may deduct from moneys otherwise due the Contractor, not as a penalty, but as Liquidated Damages in accordance with Sections 107.7 and 107.8 of the *State of Maine Department of Transportation Standard Specifications, March 2020 Edition* and related Special Provisions.

C. Price.

The quantities given in the Schedule of Items of the Bid Package will be used as the basis for determining the original Contract amount and for determining the amounts of the required Performance Surety Bond and Payment Surety Bond, and that the amount of this offer is _____

_____ \$ _____ Performance Bond and Payment Bond each being 100% of the amount of this Contract.

D. Contract.

This Contract, which may be amended, modified, or supplemented in writing only, consists of the Contract documents as defined in the Plans, *Standard Specifications, March 2020 Edition, Standard Details March 2020 Edition* as updated through advertisement, Supplemental Specifications, Special Provisions, Contract Agreement; and Contract Bonds. It is agreed and understood that this Contract will be governed by the documents listed above.

E. Certifications.

By signing below, the Contractor hereby certifies that to the best of the Contractor's knowledge and belief:

1. All of the statements, representations, covenants, and/or certifications required or set forth in the Bid and the Bid Documents, including those in the Federal Contract Provisions Supplement, and the Contract are still complete and accurate as of the date of this Agreement.
2. The Contractor knows of no legal, contractual, or financial impediment to entering into this Contract.
3. The person signing below is legally authorized by the Contractor to sign this Contract on behalf of the Contractor and to legally bind the Contractor to the terms of the Contract.

F. Offer.

The undersigned, having carefully examined the site of work, the Plans, *Standard Specifications March 2020 Edition*, *Standard Details March 2020 Edition* as updated through advertisement, Supplemental Specifications, Special Provisions, Contract Agreement; and Contract Bonds contained herein for construction of: **WIN 24923.00 for Pavement Milling and Ultra-Thin Bonded Wearing Course in the City of Caribou and Towns of Woodland & New Sweden, County of Aroostook,** State of Maine, on which bids will be received until the time specified in the “Notice to Contractors” do(es) hereby bid and offer to enter into this contract to supply all the materials, tools, equipment and labor to construct the whole of the Work in strict accordance with the terms and conditions of this Contract at the unit prices in the attached “Schedule of Items.”

The Offeror agrees to perform the work required at the price specified above and in accordance with the bids provided in the attached “Schedule of Items” in strict accordance with the terms of this solicitation, and to provide the appropriate insurance and bonds if this offer is accepted by the Government in writing.

As Offeror also agrees:

First: To do any extra work, not covered by the attached “Schedule of Items,” which may be ordered by the Resident, and to accept as full compensation the amount determined upon a “Force Account” basis as provided in the *Standard Specifications, March 2020 Edition*, and as addressed in the contract documents.

Second: That the bid bond at 5% of the bid amount or the official bank check, cashier’s check, certificate of deposit or U. S. Postal Money Order in the amount given in the “Notice to Contractors”, payable to the Treasurer of the State of Maine and accompanying this bid, shall be forfeited, as liquidated damages, if in case this bid is accepted, and the undersigned shall fail to abide by the terms and conditions of the offer and fail to furnish satisfactory insurance and Contract bonds under the conditions stipulated in the Specifications within 15 days of notice of intent to award the contract.

Third: To begin the Work as stated in Section 107.2 of the *Standard Specifications March 2020 Edition* and complete the Work within the time limits given in the Special Provisions of this Contract.

Fourth: The Contractor will be bound to the Disadvantaged Business Enterprise (DBE) Requirements contained in the attached Notice (Additional Instructions to Bidders) and submit a completed Contractor’s Disadvantaged Business Enterprise Utilization Plan with their bid.

Fifth: That this offer shall remain open for 30 calendar days after the date of opening of bids.

Sixth: The Bidder hereby certifies, to the best of its knowledge and belief that: the Bidder has not, either directly or indirectly, entered into any agreement, participated in any collusion, or otherwise taken any action in restraint of competitive bidding in connection with its bid, and its subsequent contract with the Department.

IN WITNESS WHEREOF, the Contractor, for itself, its successors and assigns, hereby execute two duplicate originals of this Agreement and thereby binds itself to all covenants, terms, and obligations contained in the Contract Documents.

CONTRACTOR

Date

(Signature of Legally Authorized Representative
of the Contractor)

Witness

(Name and Title Printed)

G. Award.

Your offer is hereby accepted.
documents referenced herein.

This award consummates the Contract, and the

MAINE DEPARTMENT OF TRANSPORTATION

Date

By: Bruce A. Van Note, Commissioner

Witness

CONTRACT AGREEMENT, OFFER & AWARD

AGREEMENT made on the date last signed below, by and between the State of Maine, acting through and by its Department of Transportation (Department), an agency of state government with its principal administrative offices located at Child Street Augusta, Maine, with a mailing address at 16 State House Station, Augusta, Maine 04333-0016, and (Name of the firm bidding the job) a corporation or other legal entity organized under the laws of the State of Maine, with its principal place of business located at (address of the firm bidding the job)

The Department and the Contractor, in consideration of the mutual promises set forth in this Agreement (the "Contract"), hereby agree as follows:

A. The Work.

The Contractor agrees to complete all Work as specified or indicated in the Contract including Extra Work in conformity with the Contract, PIN No. 1224.00, for the Hot Mix Asphalt Overlay in the town/city of South Nowhere, County of Washington, Maine. The Work includes construction, maintenance during construction, warranty as provided in the Contract, and other incidental work.

The Contractor shall be responsible for furnishing all supervision, labor, equipment, tools supplies, permanent materials and temporary materials required to perform the Work including construction quality control including inspection, testing and documentation, all required documentation at the conclusion of the project, warranting its work and performing all other work indicated in the Contract.

The Department shall have the right to alter the nature and extent of the Work as provided in the Contract; payment to be made as provided in the same.

B. Time.

The Contractor agrees to complete all Work, except warranty work, on or before November 15, 2006. Further, the Department may deduct from moneys otherwise due the Contractor, not as a penalty, but as Liquidated Damages in accordance with Sections 107.7 and 107.8 of the State of Maine Department of Transportation Standard Specifications, November 2014 Edition and related Special Provisions.

C. Price.

The quantities given in the Schedule of Items of the Bid Package will be used as the basis for determining the original Contract amount and for determining the amounts of the required Performance Surety Bond and Payment Surety Bond, and that the amount of this offer is (Place bid here in alphabetical form such as One Hundred and Two dollars and 10 cents)
\$ (repeat bid here in numerical terms, such as \$102.10) Performance Bond and Payment Bond each being 100% of the amount of this Contract.

D. Contract.

This Contract, which may be amended, modified, or supplemented in writing only, consists of the Contract documents as defined in the Plans, Standard Specifications, November 2014 Edition, Standard Details November 2014 Edition, Supplemental Specifications, Special Provisions, Contract Agreement, and Contract Bonds. It is agreed and understood that this Contract will be governed by the documents listed above.

E. Certifications.

By signing below, the Contractor hereby certifies that to the best of the Contractor's knowledge and belief:

1. All of the statements, representations, covenants, and/or certifications required or set forth in the Bid and the Bid Documents, including those in Appendix A to Division 100 of the Standard Specifications November 2014 Edition (Federal Contract Provisions Supplement), and the Contract are still complete and accurate as of the date of this Agreement.
2. The Contractor knows of no legal, contractual, or financial impediment to entering into this Contract.
3. The person signing below is legally authorized by the Contractor to sign this Contract on behalf of the Contractor and to legally bind the Contractor to the terms of the Contract.

F. Offer.

The undersigned, having carefully examined the site of work, the Plans, Standard Specifications, November 2014 Edition, Standard Details November 2014 Edition, Supplemental Specifications, Special Provisions, Contract Agreement; and Contract Bonds contained herein for construction of:

PIN 1234.00 South Nowhere, Hot Mix Asphalt Overlay,

State of Maine, on which bids will be received until the time specified in the "Notice to Contractors" do(es) hereby bid and offer to enter into this contract to supply all the materials, tools, equipment and labor to construct the whole of the Work in strict accordance with the terms and conditions of this Contract at the unit prices in the attached "Schedule of Items".

The Offeror agrees to perform the work required at the price specified above and in accordance with the bids provided in the attached "Schedule of Items" in strict accordance with the terms of this solicitation, and to provide the appropriate insurance and bonds if this offer is accepted by the Government in writing.

As Offeror also agrees:

First: To do any extra work, not covered by the attached "Schedule of Items", which may be ordered by the Resident, and to accept as full compensation the amount determined upon a "Force Account" basis as provided in the Standard Specifications, November 2014 Edition, and as addressed in the contract documents.

Second: That the bid bond at 5% of the bid amount or the official bank check, cashier's check, certificate of deposit or U. S. Postal Money Order in the amount given in the "Notice to Contractors", payable to the Treasurer of the State of Maine and accompanying this bid, shall be forfeited, as liquidated damages, if in case this bid is accepted, and the undersigned shall fail to abide by the terms and conditions of the offer and fail to furnish satisfactory insurance and Contract bonds under the conditions stipulated in the Specifications within 15 days of notice of intent to award the contract.

Third: To begin the Work as stated in Section 107.2 of the Standard Specifications November 2014 Edition and complete the Work within the time limits given in the Special Provisions of this Contract.

Fourth: The Contractor will be bound to the Disadvantaged Business Enterprise (DBE) Requirements contained in the attached Notice (Additional Instructions to Bidders) and submit a completed Contractor's Disadvantaged Business Enterprise Utilization Plan with their bid.

Fifth: That this offer shall remain open for 30 calendar days after the date of opening of bids.

Sixth: The Bidder hereby certifies, to the best of its knowledge and belief that: the Bidder has not, either directly or indirectly, entered into any agreement, participated in any collusion, or otherwise taken any action in restraint of competitive bidding in connection with its bid, and its subsequent contract with the Department.

IN WITNESS WHEREOF, the Contractor, for itself, its successors and assigns, hereby execute two duplicate originals of this Agreement and thereby binds itself to all covenants, terms, and obligations contained in the Contract Documents.

Date

(Witness Sign Here)
Witness

(Sign Here)
(Signature of Legally Authorized Representative of the Contractor)

(Print Name Here)
(Name and Title Printed)

CONTRACTOR

G. Award.

Your offer is hereby accepted.
documents referenced herein.

This award consummates the Contract, and the

MAINE DEPARTMENT OF TRANSPORTATION

Date

By: David Bernhardt, Commissioner

(Witness)

STATE OF MAINE
DEPARTMENT OF TRANSPORTATION



CARIBOU - NEW SWEDEN

AROOSTOOK COUNTY

ROUTE 161

FEDERAL PROJECT NO. 2492300

PROJECT LENGTH: 9.80 MILES

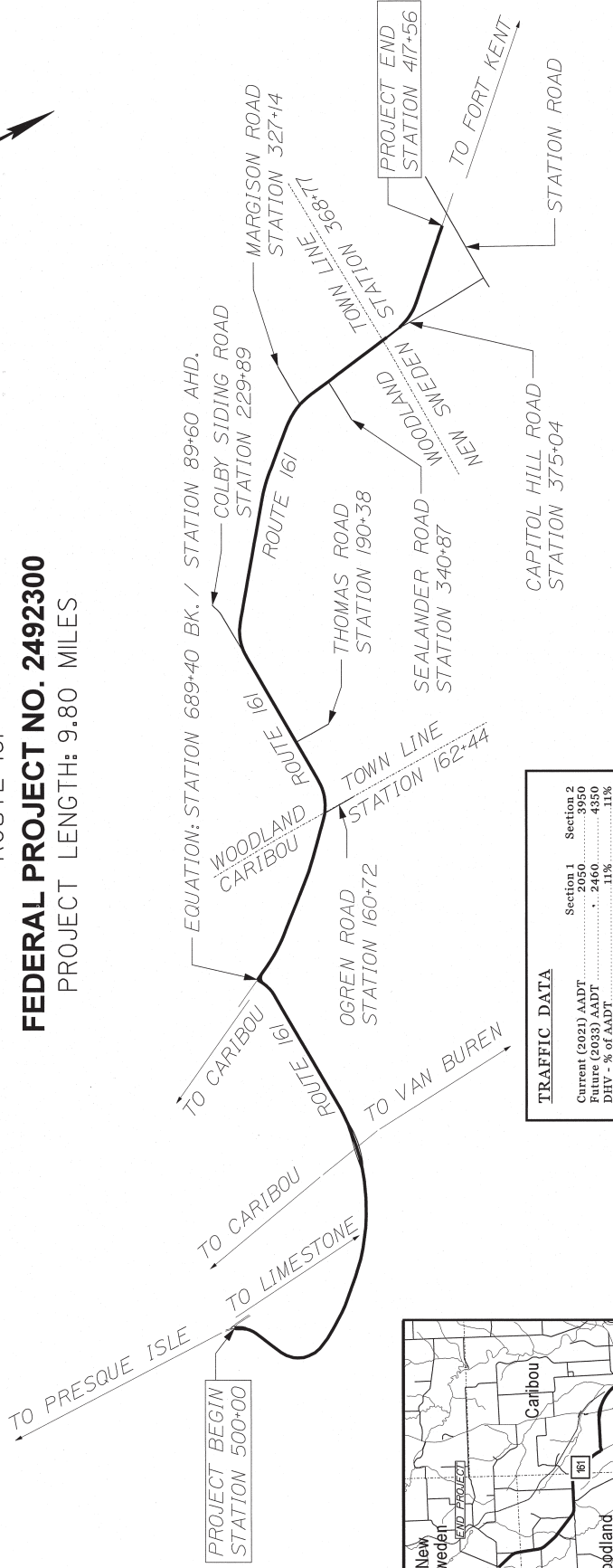

TRAFFIC DATA

	Section 1	Section 2
Current (2021) AADT	2050	3950
Future (2033) AADT	2460	4350
DHV - % of AADT	11%	11%
Design Hour Volume	271	478
% Heavy Trucks (AADT)	16%	9%
Design Hour Volume (DHV)	65%	62%
18-KIP Equivalent P 2.0	234	264
18-KIP Equivalent P 2.5	223	251
Design Speed (mph)	50	50
Functional Class:	MINOR ARTERIAL	
Corridor Priority:	2	

PROJECT LOCATION:	BEGINNING AT THE SOUTH JUNCTION OF US ROUTE 1 AND EXTENDING NORTHWEST 9.80 MILES TO 0.08 OF A MILE SOUTHEAST OF THIS STATION ROAD.
PROGRAM AREA:	HIGHWAY PROGRAM
SCOPE OF WORK:	ULTRA-THIN BONDED WEARING COURSE

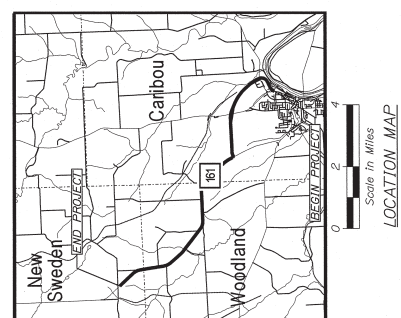

STATE OF MAINE
DEPARTMENT OF TRANSPORTATION

APPROVED

DATE: 5-21-21

COMMISSIONER: [Signature]

CHIEF ENGINEER: [Signature]

STATE OF MAINE
PROFESSIONAL ENGINEER

8231

DATE: 3/2/2021

P.E. NUMBER: 8231

SIGNATURE: [Signature]

PROJECT INFORMATION

PROJECT: CARIBOU - NEW SWEDEN

PROGRAM: HIGHWAY

PROJECT MANAGER: ROGER SPOUR

DESIGNER: SPENCER MAYNARD

CONSULTANT: [Blank]

PROJECT RESIDENT: [Blank]

CONTRACTOR: [Blank]

PROJECT COMPLETION DATE: [Blank]

TITLE SHEET

ROUTE 161

CARIBOU - NEW SWEDEN

SHEET NUMBER

1

OF 1

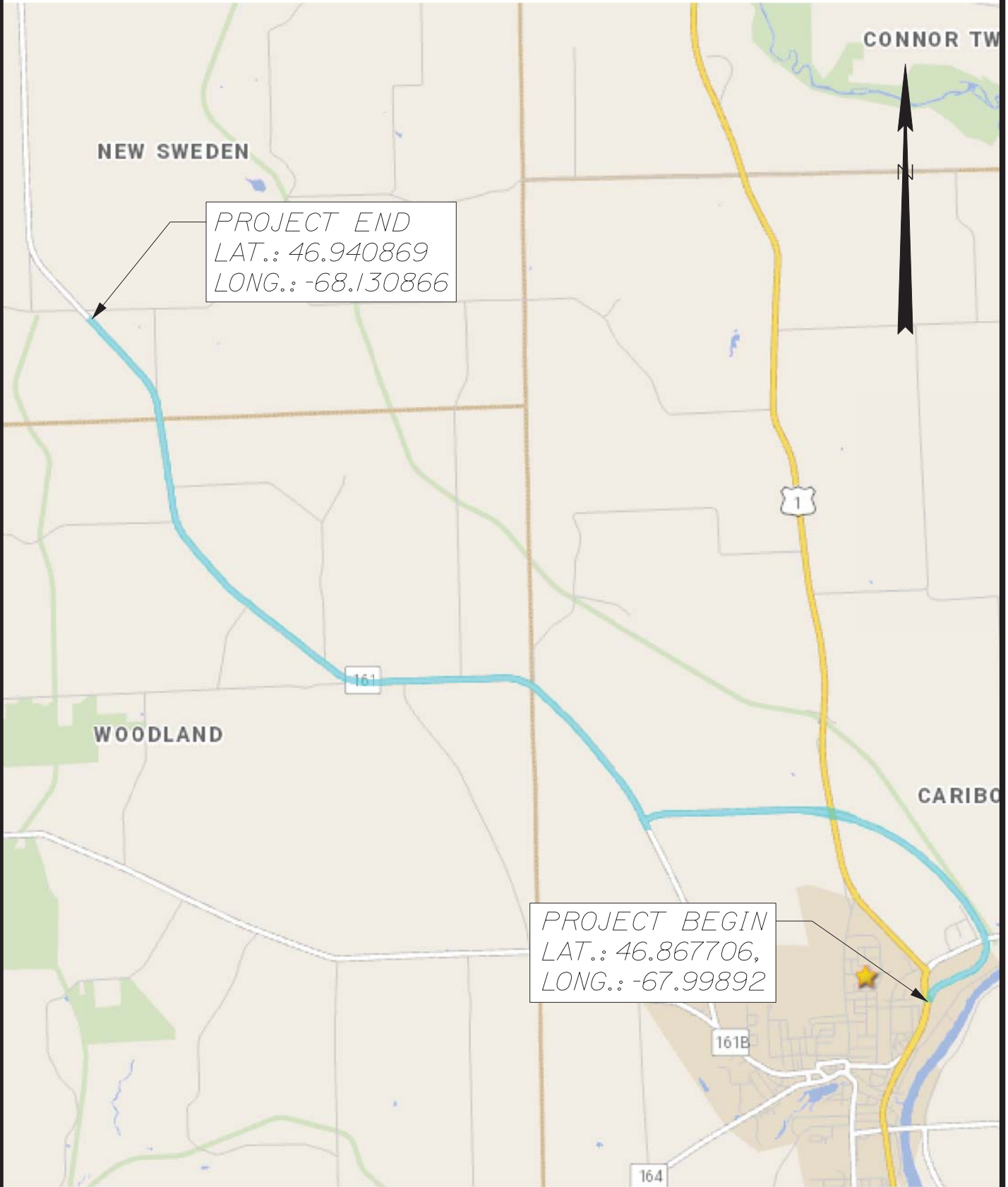

STATE OF MAINE
DEPARTMENT OF TRANSPORTATION

ROUTE 161 CARIBOU - NEW SWEDEN
AROOSTOOK COUNTY

SHEET NUMBER

1
32

24923.00

LOCATION MAP

OF 1

*3/4" ULTRA-THIN BONDED WEARING COURSE
TRAVELWAY ONLY*

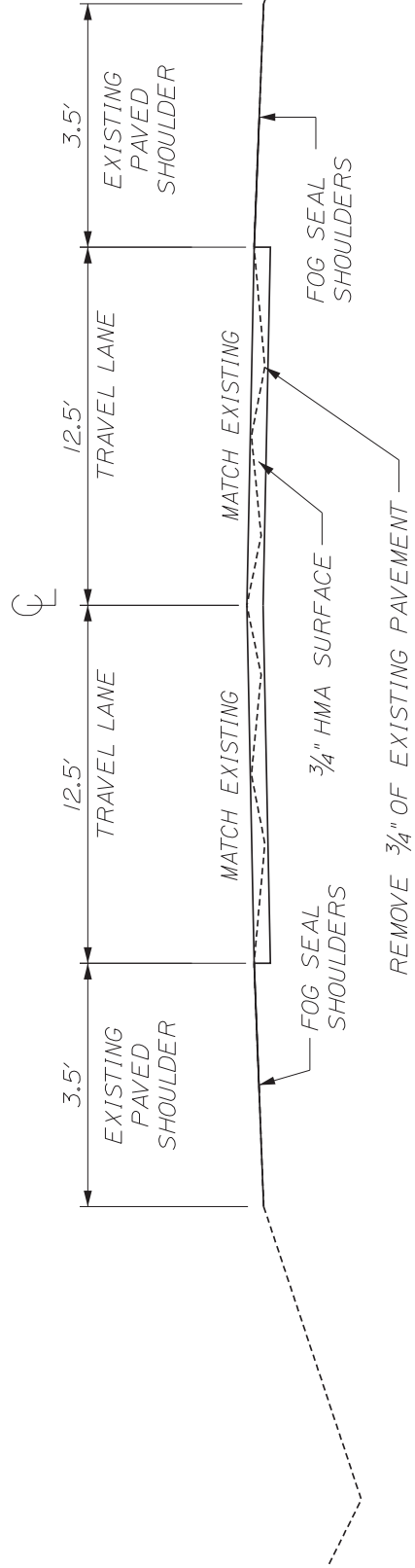

NOT TO SCALE
SHEET NUMBER
1 OF 6

STATE OF MAINE
DEPARTMENT OF TRANSPORTATION
2492300
HIGHWAY PLANS

CARIBOU - NEW SWEDEN
ROUTE 161
WIN 24923.00

33 TYPICAL SECTIONS

*3/4" ULTRA-THIN BONDED WEARING COURSE
TRAVELWAY ONLY*

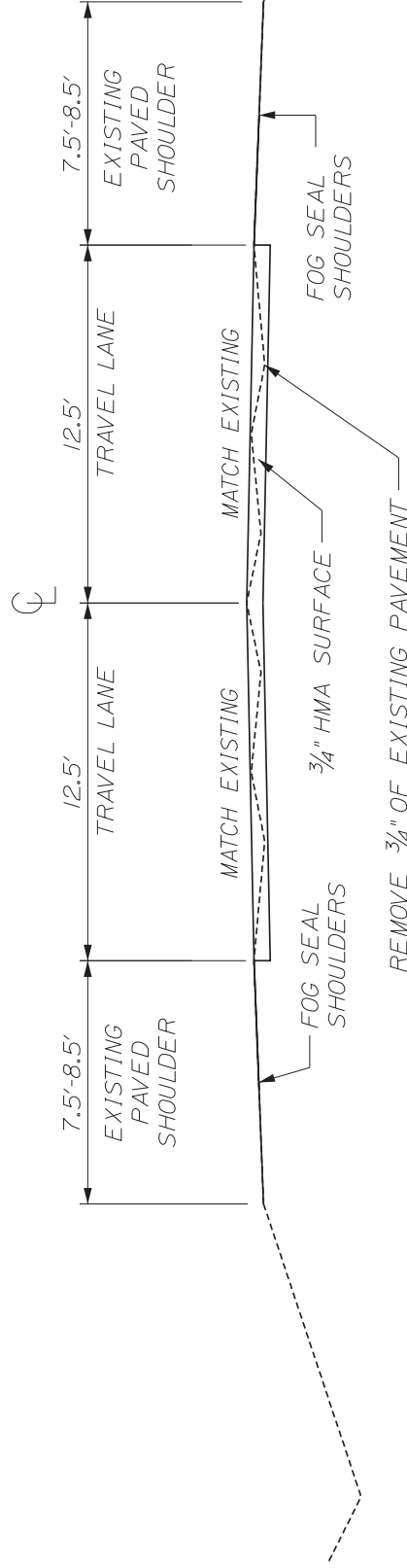

CARIBOU - NEW SWEDEN ROUTE 161 TYPICAL SECTIONS	STATE OF MAINE DEPARTMENT OF TRANSPORTATION 2492300	HIGHWAY PLANS 2492300	NOT TO SCALE SHEET NUMBER 2 OF 6
34			

3/4" MILL AND UTBWC
GUARDRAIL SECTIONS

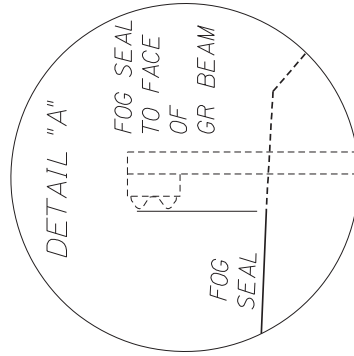
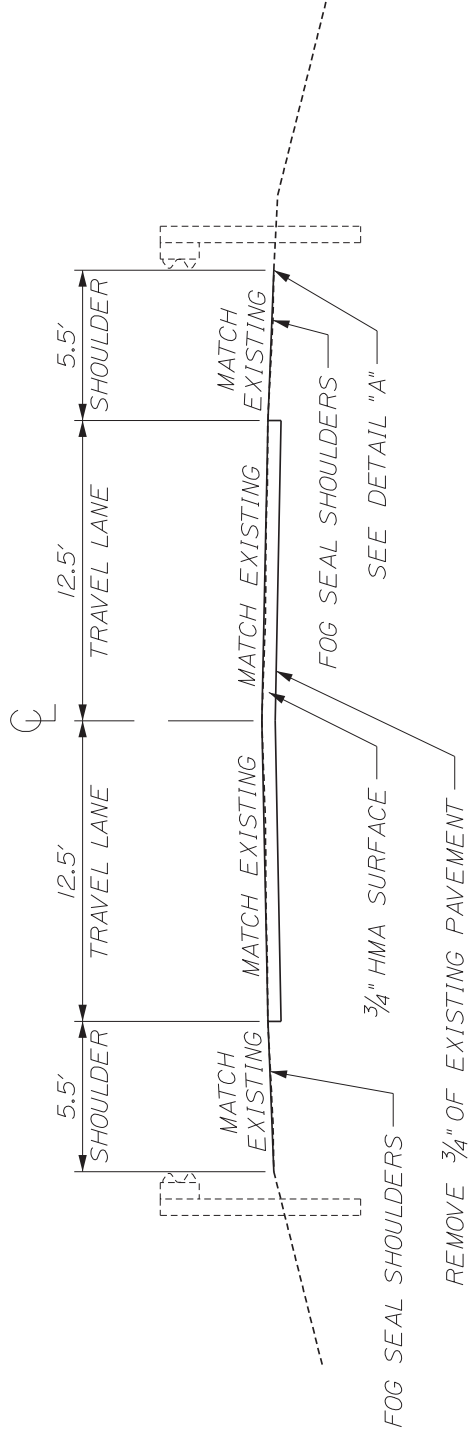

NOT TO SCALE
SHEET NUMBER
3 OF 6

STATE OF MAINE
DEPARTMENT OF TRANSPORTATION
2492300
HIGHWAY PLANS

WIN 24923.00

CARIBOU - NEW SWEDEN
ROUTE 161
TYPICAL SECTIONS

3/4" MILL AND UTBWC
GUARDRAIL SECTIONS

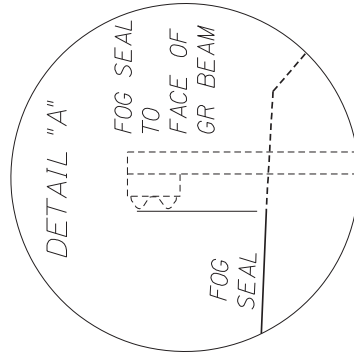
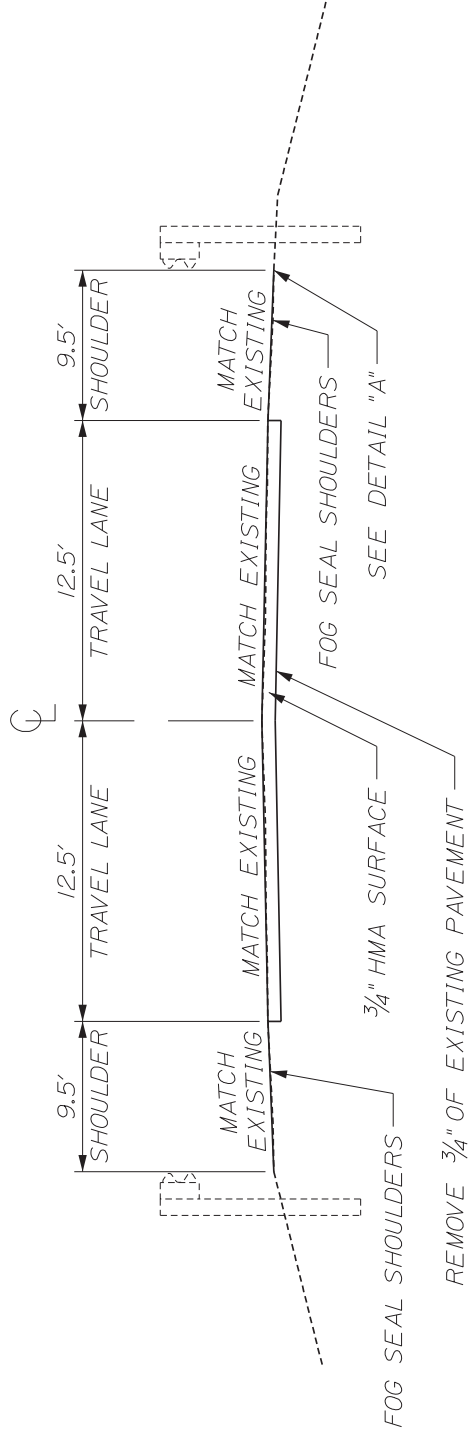

NOT TO SCALE
SHEET NUMBER
4 OF 6

STATE OF MAINE
DEPARTMENT OF TRANSPORTATION
2492300
HIGHWAY PLANS

WIN 24923.00

CARIBOU - NEW SWEDEN
ROUTE 161
TYPICAL SECTIONS

*3/4" ULTRA-THIN BONDED WEARING COURSE
EXISTING DIVIDED CENTER ISLAND*

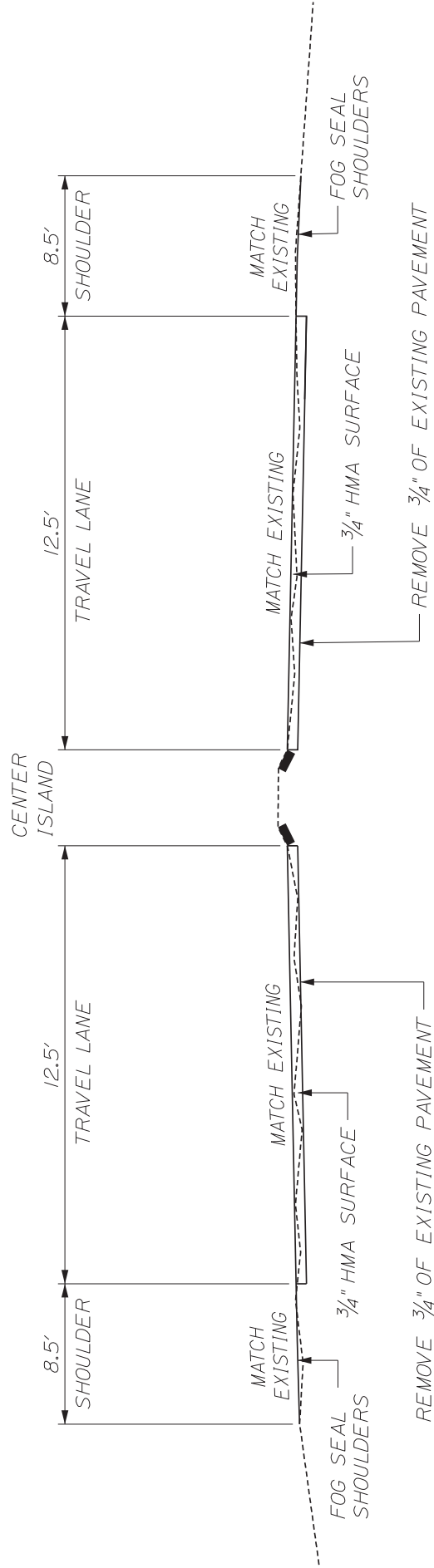

CARIBOU - NEW SWEDEN ROUTE 161 TYPICAL SECTIONS	WIN 24923.00	STATE OF MAINE DEPARTMENT OF TRANSPORTATION 2492300 HIGHWAY PLANS	NOT TO SCALE SHEET NUMBER 5 OF 6
---	--------------	--	--

*3/4" ULTRA-THIN BONDED WEARING COURSE
DIVIDED HIGHWAY
NORTHBOUND RAMPS & SOUTHBOUND RAMPS*

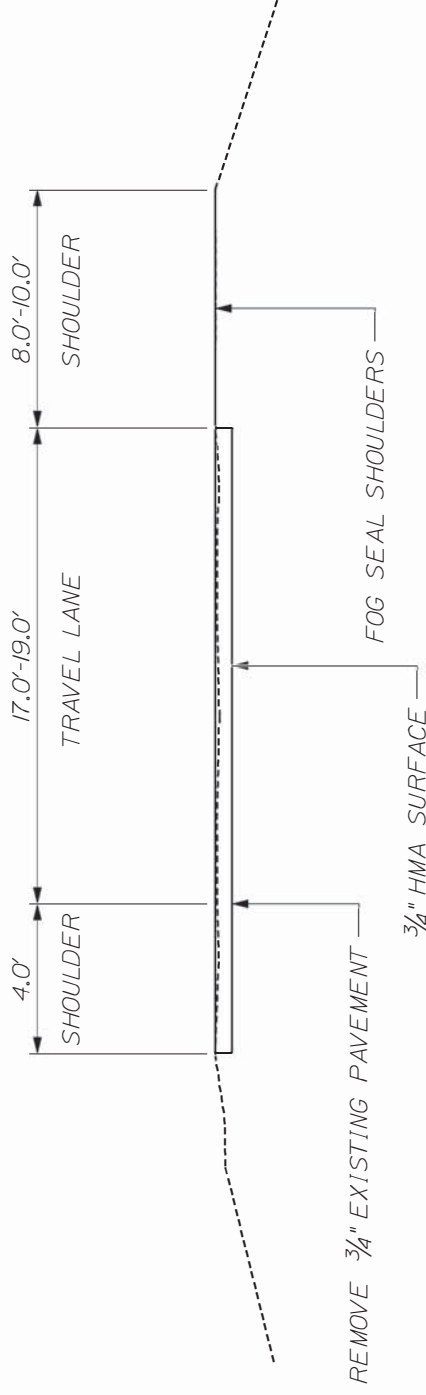

NOT TO SCALE
SHEET NUMBER
6 OF 6

STATE OF MAINE
DEPARTMENT OF TRANSPORTATION
2492300
HIGHWAY PLANS

WIN 24923.00

CARIBOU - NEW SWEDEN
ROUTE 161
TYPICAL SECTIONS

Project Stationing

<u>Left</u>	<u>Station</u>	<u>Right</u>
Lane Ends Merge Left sign	602+97	
light Pole	599+18	
South On Ramp 800+00	598+65	North Off Ramp 700+00
Light Pole	597+94	
	594+90	North U.S. Route 1 sign
X- pipe	573+00	X- pipe
X- pipe	559+10	X- pipe
End Guardrail	558+72	
	558+35	End Guardrail
Center of Park and Ride overpass	556+00	Center of Park and Ride overpass
Begin Guardrail	554+27	
	552+45	Begin Guardrail
	540+23	End Guardrail
End Guardrail	538+32	
Begin Guardrail	532+08	
	530+96	Begin Guardrail
45 MPH	509+62	
End Guardrail	509+02	
	508+76	55 MPH
	507+61	End Guardrail
Begin Guardrail	504+54	
	503+12	Begin Guardrail
North end of island	502+84	North end of island
Begin Project	500+00	Begin Project

Project Stationing

<u>Left</u>	<u>Station</u>	<u>Right</u>
	681+99	JCT 161B sign
	678+92	1000' sign
End Guardrail	653+02	
	652+75	End Guardrail
Center of 4 wheeler overpass	647+82	Center of 4 wheeler overpass
Begin Guardrail	640+30	
	639+27	Begin Guardrail
Bennett Drive Business District sign	634+34	
	633+00	North On Ramp 734+50
South Off Ramp 832+10	632+57	
Hospital sign	632+32	
Van Buren/Caribou sign	631+24	Light pole
	629+78	Light pole
	629+46	Lane Ends Merge Left sign
	628+44	Light pole
Light pole	627+91	
	627+33	Light pole
Exit sign	624+66	
	623+69	End Guardrail
End Guardrail	622+92	
	622+66	Merge arrow sign
Begin Guardrail	609+02	
	608+17	Exit sign
	607+78	Begin Guardrail

Project Stationing

<u>Left</u>	<u>Station</u>	<u>Right</u>
	165+57	pole 62525
Caribou/Woodland Town Line	162+44	Caribou/Woodland Town Line
	160+72	Ogren Road
pole 62523	157+38	
pole 62521	152+82	
pole 35974	149+46	
	144+48	pole 26186
pole 62510	140+12	
	135+23	pole 26171
pole 71320	130+29	
pole 26182	125+80	
pole 71324	121+57	
pole 71326	117+19	
pole 71328	113+36	
	108+50	pole 71347
pole 71333	104+88	
pole 71334	101+40	
	98+77	North Off Ramp 907+04
	97+40	pole 71519
Pole 71522	89+92	
Begin Junction of 161B / 161	89+60	Begin Junction of 161B / 161
Station Equation 689+40 Back/89+60 Ahead		
Begin Junction of 161B / 161	689+40	Begin Junction of 161B / 161
	688+79	Stop sign
55 MPH sign	686+00	
	685+94	Caribou/Fort Kent sign
X- pipe	685+45	X- pipe
	685+40	North Off Ramp 900+00
South 161 sign	683+96	South/ North 161B/161 sign

Project Stationing

<u>Left</u>	<u>Station</u>	<u>Right</u>
pole 29998	264+74	
pole 29996	260+82	
pole 29994	356+72	
pole 62406	252+88	
pole 62408	249+22	
	246+08	Beckstrom Road
pole 05350	242+93	
pole 62402	238+51	
pole 62403	234+07	
Colby Siding Road	229+89	
pole 62410	226+05	
pole 05349	221+68	
pole 05069	217+50	
Brown Road	212+71	
pole 35975	210+81	
pole 35977	206+54	
pole 35979	202+48	
pole 62542	198+68	
pole 62544	195+18	
	190+38	Thomas Road
pole 62536	188+57	
pole 62535	183+90	
pole 62533	181+49	
pole 62531	177+12	
	173+33	pole 62529
	169+54	pole 62527

Project Stationing

<u>Left</u>	<u>Station</u>	<u>Right</u>
End Project	417+56	End Project
	416+08	pole 27026
	411+08	pole 27029
	406+23	pole 27033
	401+55	pole 11
	396+78	pole 9
	392+11	pole 7
	387+47	pole 65002
	382+50	pole 30128
	378+23	pole 30125
	375+04	Capitol Hill Road
	372+01	pole 30082
Woodland/New Sweden Town Line	368+77	Woodland/New Sweden Town Line
	367+27	pole 30078
	362+54	pole 30074
	357+79	pole30072
	353+07	pole 30066
	348+30	pole 30064
	343+54	pole 30062
	340+87	Sealander Road
	336+52	pole 30056
	331+90	pole 30052
Margison Road	327+14	
	322+31	pole 30040
	317+36	pole 30036
	312+52	pole30034
	307+84	pole 30032
	303+12	pole 30030
	298+59	pole 30027
	294+06	pole 30023
	289+57	pole 30019
	286+13	pole 30016
Goodwin Road	284+21	
pole 30012	282+41	
pole 30010	278+27	
pole 30007	273+62	
pole 62407	269+02	

Ramp 700 Stationing

<u>Left</u>	<u>Station</u>	<u>Right</u>
Connector	734+50	North On Ramp 633+00 Mainline
	733+88	Light Pole
	732+65	Light Pole
	731+40	Light Pole
	731+10	Lane Ends Merge Left sign
	730+00	Light Pole
	728+90	Light Pole
	726+80	Yeild sign
Wrong Way sign	724+40	Wrong Way sign
U.S. Route 1 Edge of Pave	717+35	U.S. Route 1 on ramp North
U.S. Route 1 Edge of Pave	716+96	U.S. Route 1 off ramp North / South
	716+85	Stop Bar
	716+55	Painted STOP
Wrong Way sign	715+50	Caribou/Van Buren sign
	714+05	U.S. Route 1 South/North sign
	712+22	Painted AHD
Stop Ahead sign	711+97	Stop Ahead sign
	711+90	Painted STOP
Exit sign	709+55	
Connector	700+00	North Off Ramp 598+65 Mainline

Ramp 800 Stationing

<u>Left</u>	<u>Station</u>	<u>Right</u>
South Off Ramp 632+57 Mainline	832+10	Connector
Light pole	829+28	
Light pole	828+08	
Light pole	826+90	
	826+00	Exit sign
Painted STOP	820+57	
Stop Ahead sign	820+27	Stop Ahead sign
Painted AHD	820+08	
US Route 1 North/South sign	819+09	
Pole 815	818+38	
Caribou/Van Buren sign	817+97	Wrong Way sign
Painted STOP	816+99	
Stop Bar	816+72	
US Route 1 off ramp North / South	816+60	US Route 1 Edge of Pave
US Route 1 on ramp South	816+23	US Route 1 Edge of Pave
Wrong Way sign	811+40	Wrong Way sign
Yeild sign	809+92	
Lane Ends Merge Left sign	804+67	
Light pole	803+26	
Light pole	802+00	
Light pole	800+77	
South On Ramp 598+65 Mainline	800+00	Connector

Ramp 900 Stationing

Left

Station

Right

Route 161	907+04	North Off Ramp 98+77 Mainline
pole 71520	905+55	
End island	904+41	
	903+92	Light pole
	903+06	Light pole
Begin island	902+00	
	901+89	Light pole
Connector	900+00	North Off Ramp 685+40 Mainline

Construction Notes

202.2023 Removing Pavement Surface – Medium Cut Drum

<u>Station</u>	<u>to</u>	<u>Station</u>	<u>Width</u>	<u>Side</u>	<u>Description</u>
500+00	-	502+84	12.5'	RT	Mainline (Bypass)
500+00	-	502+84	12.5'	LT	Mainline (Island)
502+84	-	689+40	25'	LT/RT	Mainline (Bypass)
89+60	-	417+56	24'	LT/RT	Mainline & 161B/161 Junc.
90+77	-	95+25	15'	LT	Connector passing lane South

Ramps

<u>Station</u>	<u>to</u>	<u>Station</u>	<u>Width</u>	<u>Side</u>	<u>Description</u>
700+00	-	706+25	Variable	RT	Off Ramp (Bypass)
706+25	-	716+96	18'	RT	Off Ramp (Bypass)
US Route. 1					US Route 1
717+35	-	726+58	18'	RT	On Ramp (Bypass)
726+58	-	734+50	Variable	RT	On Ramp (Bypass)
800+00	-	806+22	Variable	LT	On Ramp (Bypass)
806+22	-	816+23	17'	LT	On Ramp (Bypass)
US Route. 1					US Route. 1
816+60	-	826+13	19'	LT	Off Ramp (Bypass)
826+13	-	832+10	Variable	LT	Off Ramp (Bypass)
900+00	-	902+00	Variable	RT	Off Ramp (Bypass)
902+00	-	904+42	22'	RT	Off Ramp (Bypass)
904+42	-	907+04	Variable	RT	Off Ramp Rte. 161

Note:

- Above locations are estimates only and may be changed by the Resident. Actual depth may be determined in the field by the Resident.
- Mainline will be ground at a depth of ¾" as shown above unless otherwise noted for the entire width of the travel way from joint to joint or as determined in the field by the Resident.
- Millings/grindings will become property of the MaineDOT. Pavement millings/grindings shall be delivered and stockpiled at the MaineDOT Maintenance lot in Frenchville, Maine located on Route 162. Payment for delivery and stockpiling will be incidental to Item 202.2023. Stockpiling shall include all equipment, personnel, and all other necessary incidentals required to construct stockpiles as per normal construction practices.

Construction Notes

410.151 Emulsified Asphalt Sealcoat, Applied

<u>Description</u>	<u>Station</u>	<u>to</u>	<u>Station</u>	<u>Width</u>	<u>Comments</u>
Shoulder LT/RT	500+00	-	502+41	8.5'	
Shoulder RT/LT	502+41	-	508+14	9.5'	
Shoulder RT	508+14	-	530+18	8.5'	
Shoulder LT	508+14	-	532+09	8.5'	
Shoulder RT	530+18	-	540+70	9.5'	
Shoulder LT	532+09	-	538+70	9.5'	
Shoulder RT	540+70	-	552+00	8.5'	
Shoulder LT	538+70	-	552+80	8.5'	
Shoulder RT	552+00	-	558+93	9.5'	
Shoulder LT	552+80	-	559+33	9.5'	
Shoulder RT	558+93	-	598+65	8.5'	
Shoulder LT	559+33	-	598+65	7.5'	
Skip Ramp					
Exit RT	605+65	-	607+88	22'	0 to 22' Triangle
Exit LT	605+65	-	607+88	16'	0 to 16' Triangle
Shoulder RT	607+88	-	624+50	9.5'	
Shoulder LT	607+88	-	609+00	8.5'	
Shoulder LT	609+00	-	623+56	9.5'	
Shoulder LT	623+56	-	625+00	7.5'	
Shoulder LT	624+50	-	627+68	21'	0 to 21 Triangle
Shoulder RT	625+00	-	627+27	15'	0 to 15 Triangle
Skip Ramp					
Shoulder LT	631+00	-	639+80	7.5'	
Shoulder RT	632+57	-	638+64	7.5'	
Shoulder RT	638+64	-	653+65	9.5'	
Shoulder LT	639+80	-	653+65	9.5'	
Shoulder LT	653+65	-	689+50	8.5'	
Shoulder RT	653+65	-	686+18	7.5'	
Ramp 1 RT	700+00	-	717+00	9'	Shoulders
	717+60	-	734+50	9'	
Ramp 2 LT	800+00	-	815+90	9'	Shoulders
	816+75	-	832+10	9'	
Ramp 3 RT	900+00	-	902+00	8'	Shoulders
Shoulder RT	904+42	-	907+04	4'	
Shoulder RT	89+60	-	417+56	4'	Junction of Route 161B/161
Shoulder LT	89+60	-	90+77	4'	
Shoulder LT	95+25	-	417+56	4'	
Shoulder LT	247+37	-	250+73	6'	

Construction Notes

410.151 Emulsified Asphalt Sealcoat, Applied continued....

<u>Description</u>	<u>Station</u>	<u>to</u>	<u>Station</u>	<u>Width</u>	<u>Comments</u>
Shoulder RT	247+95	-	250+45	6'	
Shoulder RT	283+95	-	287+95	6'	
Shoulder LT	285+23	-	287+35	6'	

Note:

- To be done after Ultra-Thin Bonded Wearing Course paving is complete and prior to final striping

410.161 Cover Coat Material, Sand

<u>Description</u>	<u>Station</u>	<u>Length</u>	<u>Width</u>	<u>Side</u>
Ogren Road	160+72	90'	4'	RT
Thomas Road	190+38	72'	4'	RT
Brown Road	212+71	47'	4'	LT
Colby Siding Road	229+89	200'	8'	LT
Beckstrom Road	246+08	76'	4'	RT
Goodwin Road	284+21	72'	4'	LT
Margison Road	327+14	72'	4'	LT
Sealander Road	340+87	67'	4'	RT
Capitol Hill Road	375+04	175'	4'	RT

Note:

- Above locations are estimates only, exact locations will be determined by the Resident.

424.22 Asphalt Rubber Crack Sealer Type 2, Applied

This item to be used to seal cracks on existing mainline travel way after milling and prior to the placement of the 3/4" Ultra-Thin Bonded Wearing Course. This item will also be used for the sealing of cracks on paved shoulders prior to the application of the Emulsified Asphalt Sealcoat.

Construction Notes

462.301 Polymer Modified Ultra-Thin Bonded Wearing Course

<u>Station</u>	<u>to</u>	<u>Station</u>	<u>Width</u>	<u>Side</u>	<u>Description</u>
500+00	-	502+84	12.5'	RT	Mainline (Bypass)
500+00	-	502+84	12.5'	LT	Mainline (Island)
502+84	-	689+40	25'	LT/RT	Mainline (Bypass)
89+60	-	417+56	24'	LT/RT	Mainline & 161B/161 Junc.
90+77	-	95+25	15'	LT	Connector passing lane South

Ramps

<u>Station</u>	<u>to</u>	<u>Station</u>	<u>Width</u>	<u>Side</u>	<u>Description</u>
700+00	-	706+25	Variable	RT	Off Ramp (Bypass)
706+25	-	716+96	18'	RT	Off Ramp (Bypass)
US Route. 1					US Route. 1
717+35	-	726+58	18'	RT	On Ramp (Bypass)
726+58	-	734+50	Variable	RT	On Ramp (Bypass)
800+00	-	806+22	Variable	LT	On Ramp (Bypass)
806+22	-	816+23	17'	LT	On Ramp (Bypass)
US Route. 1					US Route. 1
816+60	-	826+13	19'	LT	Off Ramp (Bypass)
826+13	-	832+10	Variable	LT	Off Ramp (Bypass)
900+00	-	902+00	Variable	RT	Off Ramp (Bypass)
902+00	-	904+42	22'	RT	Off Ramp (Bypass)
904+42	-	907+04	Variable	RT	Off Ramp Rte. 161

627.733 4" White or Yellow Painted Pavement Marking Line

- Final striping will not commence until 10 days have elapsed from the completion of surface pavement and must be completed within 20 days of the completion of surface pavement. Unless otherwise directed, failure to comply will result in a Traffic Control Violation.
- Once construction is complete, Maintenance of Traffic Control Devices (652.36) will not be paid while waiting to final stripe.
- Once construction is complete, liquidated damages will not be charged while waiting to final stripe.

Construction Notes

627.78 Temporary 4” Painted Pavement Marking Line, White or Yellow

- Temporary center lines shall be painted on all matched pavement within one week.
- Temporary edge lines shall be painted on all pavement layers within four weeks.
- All temporary lines shall be painted prior to final striping.
- Multilane sections, truck lanes, and milled surfaces must be striped daily on all matched pavement layers.
- TOMs must be used on all pavement layers until temporary paint is applied.
- TOMs will be removed before final striping.
- TOM removal will be addressed in the Traffic Control Plan.
- Only painted temporary line will be paid under this item. TOMs will be considered incidental to the contract.
- Two applications of Temporary Striping will be applied to the final Ultra-Thin Bonded Wearing Course treatment layer

629 & 631 Hourly Items

- Primary use of the 631.12 All Purpose Excavator and 631.172 Truck-Large will be for removal of excess material from in-slopes, ditches, guardrail and ends of pipes. Actual locations will be located in the field, as directed by the Resident. Cleaning of pavement following rental work will be considered incidental to the rental items and will be done daily to the satisfaction of the Resident

652.35 Construction Signs

“ROAD WORK NEXT 10 MILES” signs are to be used on each end of the project as part of the approach sign package.

“ROAD WORK NEXT 6 MILES” and “END CONSTRUCTION” signs are to be used on the Route 161B section as part of the approach sign package.

Exact sign locations are to be approved by the Resident or representative of the MaineDOT.

General Notes

1. Pavement thicknesses shown on the typical sections are intended to be nominal.
2. Where deemed necessary by the Resident, unsuitable excess material shall be removed from the edges of shoulders and placed in designated areas or disposed of. Payment will be made under the appropriate Contract items.
3. All waste material not used on the project shall be disposed of off the project in acceptable waste areas reviewed by the Resident. Grading, seeding and mulching of waste areas shall be considered incidental.
4. Any necessary cleaning of existing pavement prior to paving (or milling) shall be incidental to the related paving (or milling) items. This includes killing and removal of all vegetative matter.
5. Cross slopes for normal and superelevated sections will be straight unless otherwise directed by the Department.
6. The Contractor will be responsible for maintaining all existing mailboxes to ensure that the mail will be deliverable. Payment for this work will be considered incidental to the contract
7. The Contractor will be responsible for maintaining all existing operational business directional signs (OBDS) to ensure that they are visible to the traveling public. Payment for this work will be considered incidental to the contract.
8. Any damage to the slopes caused by the Contractor's equipment, personnel, or operation shall be repaired to the satisfaction of the Resident. All work, equipment, and materials required to make repairs shall be at the Contractor's expense.
9. Areas on the project requiring fill will come from suitable sites such as excavation, ditch and inslope or equipment rental areas.
10. No separate payment for superintendent or foreman will be made for the supervision of equipment and layout of work being paid for under the equipment rental items.
11. "Undetermined locations" shall be determined by the Resident.
12. Stations referenced are approximate.
13. The Contractor will place appropriately-marked stakes at the following locations on the project: striping pattern changes, cross-slope changes, and every 500 feet for stationing. The Contractor will paint every full station (100 feet) on the existing roadway and will transfer the painted stationing through all intermediate lifts (not surface). Appropriately-sized striping pattern changes will be painted on surface. Stationing control must be placed before work can commence. Cross-slope and striping change controls must be placed before paving can commence.

SPECIAL PROVISION
SECTION 101
CONTRACT INTERPRETATION
(Working Day – Pavement Preservation)

Add the following to 101.2 – Definitions:

Weather Event Any precipitation, such as rain, sleet, snow, or fog that causes wet pavement that prevents the contractor from completing work within the Construction Limits as determined by the Department. This excludes ambient air temperatures below Specification.

Weather Dependent Activities Contractor scheduled work that cannot be completed should a Weather Event occur. Paving or other activities as determined by the Department will be considered Weather Dependent Activities.

Working Day Any Calendar Day except:

- Identified non-work days in the Contract Special Provision 107
- Saturdays, Sundays and Holidays – as outlined in Section 107.3.3
- The period from November 15th to April 15th, inclusive
- Any day a Weather Event prevents the Contractor from performing at least seven hours of weather dependent activities, as determined by the Department. Up to a three-hour hold prior to the start of work may be required if weather conditions are uncertain.

The Contractor may request, in writing, a non-working day due to a Weather Event up to 16 hours in advance of the normal start time. The Department may approve this request depending on the certainty of the forecast.

If the Contractor elects to work a Saturday, an allowable holiday, or receives approval to work Sunday, the same process will be utilized to determine if it is a Working Day.

If the Contractor requests approval to work Saturday and does not cancel their request by Thursday at the end of shift, that Saturday will be considered a Working Day regardless of the actual weather conditions and whether work occurred.

SPECIAL PROVISION
SECTION 104
(WAGE RATES)

When two or more wage rate schedules appear in the bid Book, the highest rate shall prevail for each classification.

"General Decision Number: ME20210034 01/01/2021

Superseded General Decision Number: ME20200034

State: Maine

Construction Type: Highway

County: Aroostook County in Maine.

HIGHWAY CONSTRUCTION PROJECTS

Note: Under Executive Order (EO) 13658, an hourly minimum wage of \$10.95 for calendar year 2021 applies to all contracts subject to the Davis-Bacon Act for which the contract is awarded (and any solicitation was issued) on or after January 1, 2015. If this contract is covered by the EO, the contractor must pay all workers in any classification listed on this wage determination at least \$10.95 per hour (or the applicable wage rate listed on this wage determination, if it is higher) for all hours spent performing on the contract in calendar year 2021. If this contract is covered by the EO and a classification considered necessary for performance of work on the contract does not appear on this wage determination, the contractor must pay workers in that classification at least the wage rate determined through the conformance process set forth in 29 CFR 5.5(a)(1)(ii) (or the EO minimum wage rate, if it is higher than the conformed wage rate). The EO minimum wage rate will be adjusted annually. Please note that this EO applies to the above-mentioned types of contracts entered into by the federal government that are subject to the Davis-Bacon Act itself, but it does not apply to contracts subject only to the Davis-Bacon Related Acts, including those set forth at 29 CFR 5.1(a)(2)-(60). Additional information on contractor requirements and worker protections under the EO is available at www.dol.gov/whd/govcontracts.

Modification Number	Publication Date
0	01/01/2021

* ENGI0004-005 04/01/2018

	Rates	Fringes
POWER EQUIPMENT OPERATOR:		
Grader/Blade, Milling Machine, Paver (Asphalt, Aggregate, and Concrete), Roller Asphalt.....	\$ 22.61	12.50

SUME2014-029 06/23/2017

	Rates	Fringes
CARPENTER, Includes Form Work....	\$ 18.34	2.84
HIGHWAY/PARKING LOT STRIPING:		
Laborer.....	\$ 14.29	1.89
IRONWORKER, REINFORCING.....	\$ 16.27	0.00

LABORER: Asphalt, Includes Raker, Shoveler, Spreader and Distributor.....	\$ 14.32	3.17
LABORER: Common or General.....	\$ 13.23	1.22
LABORER: Wheelman.....	\$ 15.40	3.01
OPERATOR: Backhoe/Excavator/Trackhoe.....	\$ 17.63	2.28
OPERATOR: Bobcat/Skid Steer/Skid Loader.....	\$ 20.36	5.06
OPERATOR: Broom/Sweeper.....	\$ 16.52	6.38
OPERATOR: Bulldozer.....	\$ 16.58	2.89
OPERATOR: Loader.....	\$ 16.21	3.23
OPERATOR: Mechanic.....	\$ 22.30	8.71
OPERATOR: Screed.....	\$ 18.82	4.75
OPERATOR: Roller (Earth).....	\$ 15.55	5.83
TRAFFIC CONTROL: Flagger.....	\$ 9.00	0.00
TRAFFIC CONTROL: Laborer-Cones/ Barricades/Barrels - Setter/Mover/Sweeper.....	\$ 17.48	5.37
TRUCK DRIVER: Dump Truck.....	\$ 14.40	7.04
TRUCK DRIVER: TackTruck.....	\$ 18.82	8.29

WELDERS - Receive rate prescribed for craft performing operation to which welding is incidental.

=====

Note: Executive Order (EO) 13706, Establishing Paid Sick Leave for Federal Contractors applies to all contracts subject to the Davis-Bacon Act for which the contract is awarded (and any solicitation was issued) on or after January 1, 2017. If this contract is covered by the EO, the contractor must provide employees with 1 hour of paid sick leave for every 30 hours they work, up to 56 hours of paid sick leave each year. Employees must be permitted to use paid sick leave for their own illness, injury or other health-related needs, including preventive care; to assist a family member (or person who is like family to the employee) who is ill, injured, or has other health-related needs, including preventive care; or for reasons resulting from, or to assist a family member (or person who is like family to the employee) who is a victim of, domestic violence, sexual assault, or stalking. Additional information on contractor requirements and worker protections under the EO is available at www.dol.gov/whd/govcontracts.

Unlisted classifications needed for work not included within the scope of the classifications listed may be added after

award only as provided in the labor standards contract clauses (29CFR 5.5 (a) (1) (ii)).

The body of each wage determination lists the classification and wage rates that have been found to be prevailing for the cited type(s) of construction in the area covered by the wage determination. The classifications are listed in alphabetical order of "identifiers" that indicate whether the particular rate is a union rate (current union negotiated rate for local), a survey rate (weighted average rate) or a union average rate (weighted union average rate).

Union Rate Identifiers

A four letter classification abbreviation identifier enclosed in dotted lines beginning with characters other than "SU" or "UAVG" denotes that the union classification and rate were prevailing for that classification in the survey. Example: PLUM0198-005 07/01/2014. PLUM is an abbreviation identifier of the union which prevailed in the survey for this classification, which in this example would be Plumbers. 0198 indicates the local union number or district council number where applicable, i.e., Plumbers Local 0198. The next number, 005 in the example, is an internal number used in processing the wage determination. 07/01/2014 is the effective date of the most current negotiated rate, which in this example is July 1, 2014.

Union prevailing wage rates are updated to reflect all rate changes in the collective bargaining agreement (CBA) governing this classification and rate.

Survey Rate Identifiers

Classifications listed under the "SU" identifier indicate that no one rate prevailed for this classification in the survey and the published rate is derived by computing a weighted average rate based on all the rates reported in the survey for that classification. As this weighted average rate includes all rates reported in the survey, it may include both union and non-union rates. Example: SULA2012-007 5/13/2014. SU indicates the rates are survey rates based on a weighted average calculation of rates and are not majority rates. LA indicates the State of Louisiana. 2012 is the year of survey on which these classifications and rates are based. The next number, 007 in the example, is an internal number used in producing the wage determination. 5/13/2014 indicates the survey completion date for the classifications and rates under that identifier.

Survey wage rates are not updated and remain in effect until a new survey is conducted.

Union Average Rate Identifiers

Classification(s) listed under the UAVG identifier indicate that no single majority rate prevailed for those classifications; however, 100% of the data reported for the classifications was union data. EXAMPLE: UAVG-OH-0010 08/29/2014. UAVG indicates that the rate is a weighted union average rate. OH indicates the state. The next number, 0010 in

the example, is an internal number used in producing the wage determination. 08/29/2014 indicates the survey completion date for the classifications and rates under that identifier.

A UAVG rate will be updated once a year, usually in January of each year, to reflect a weighted average of the current negotiated/CBA rate of the union locals from which the rate is based.

WAGE DETERMINATION APPEALS PROCESS

1.) Has there been an initial decision in the matter? This can be:

- * an existing published wage determination
- * a survey underlying a wage determination
- * a Wage and Hour Division letter setting forth a position on a wage determination matter
- * a conformance (additional classification and rate) ruling

On survey related matters, initial contact, including requests for summaries of surveys, should be with the Wage and Hour Regional Office for the area in which the survey was conducted because those Regional Offices have responsibility for the Davis-Bacon survey program. If the response from this initial contact is not satisfactory, then the process described in 2.) and 3.) should be followed.

With regard to any other matter not yet ripe for the formal process described here, initial contact should be with the Branch of Construction Wage Determinations. Write to:

Branch of Construction Wage Determinations
Wage and Hour Division
U.S. Department of Labor
200 Constitution Avenue, N.W.
Washington, DC 20210

2.) If the answer to the question in 1.) is yes, then an interested party (those affected by the action) can request review and reconsideration from the Wage and Hour Administrator (See 29 CFR Part 1.8 and 29 CFR Part 7). Write to:

Wage and Hour Administrator
U.S. Department of Labor
200 Constitution Avenue, N.W.
Washington, DC 20210

The request should be accompanied by a full statement of the interested party's position and by any information (wage payment data, project description, area practice material, etc.) that the requestor considers relevant to the issue.

3.) If the decision of the Administrator is not favorable, an interested party may appeal directly to the Administrative Review Board (formerly the Wage Appeals Board). Write to:

Administrative Review Board
U.S. Department of Labor
200 Constitution Avenue, N.W.

Washington, DC 20210

4.) All decisions by the Administrative Review Board are final.

=====

END OF GENERAL DECISION

"

State of Maine
 Department of Labor
 Bureau of Labor Standards
 Augusta, Maine 04333-0045
 Telephone (207) 623-7906

Wage Determination - In accordance with 26 MRS §1301 et. seq., this is a determination by the Bureau of Labor Standards, of the fair minimum wage rate to be paid to laborers and workers employed on the below titled project.

**2021 Fair Minimum Wage Rates
 Highway & Earth Aroostook County**

<u>Occupation Title</u>	<u>Minimum Wage</u>	<u>Minimum Benefit</u>	<u>Total</u>	<u>Occupation Title</u>	<u>Minimum Wage</u>	<u>Minimum Benefit</u>	<u>Total</u>
Asphalt Raker	\$ 19.06	\$ 4.68	\$ 23.74	Ironworker - Reinforcing	\$ 28.36	\$ 0.00	\$ 28.36
Backhoe Loader Operator	\$ 33.80	\$ 10.28	\$ 44.08	Laborer - Skilled	\$ 18.32	\$ 3.52	\$ 21.84
Boom Truck (Truck Crane) Operator	\$ 25.00	\$ 5.86	\$ 30.86	Laborers (Helpers & Tenders)	\$ 18.00	\$ 1.01	\$ 19.01
Bulldozer Operator	\$ 20.00	\$ 1.88	\$ 21.88	Loader Operator - Front-End	\$ 22.00	\$ 7.62	\$ 29.62
Carpenter - Rough	\$ 30.76	\$ 19.72	\$ 50.48	Mechanic- Maintenance	\$ 22.75	\$ 1.59	\$ 24.34
Cement Mason/Finisher	\$ 20.50	\$ 1.42	\$ 21.92	Millwright	\$ 25.75	\$ 5.41	\$ 31.16
Communication Equip Installer	\$ 22.00	\$ 0.00	\$ 22.00	Painter	\$ 20.90	\$ 2.07	\$ 22.97
Crane Operator =>15 Tons)	\$ 29.00	\$ 6.68	\$ 35.68	Paver Operator	\$ 23.91	\$ 13.25	\$ 37.16
Crusher Plant Operator	\$ 22.96	\$ 7.90	\$ 30.86	Pipelayer	\$ 25.00	\$ 3.36	\$ 28.36
Electrician - Licensed	\$ 31.98	\$ 17.24	\$ 49.22	Reclaimer Operator	\$ 26.83	\$ 13.25	\$ 40.08
Electrician Helper/Cable Puller	\$ 18.50	\$ 2.39	\$ 20.89	Roller Operator - Earth	\$ 23.91	\$ 2.97	\$ 26.88
Excavator Operator	\$ 23.74	\$ 2.26	\$ 26.00	Roller Operator - Pavement	\$ 23.91	\$ 9.21	\$ 33.12
Fence Setter	\$ 18.50	\$ 2.00	\$ 20.50	Screed/Wheelman	\$ 20.00	\$ 3.01	\$ 23.01
Flagger	\$ 13.75	\$ 0.00	\$ 13.75	Stone Mason	\$ 25.00	\$ 1.88	\$ 26.88
Grader/Scraper Operator	\$ 26.29	\$ 10.70	\$ 36.99	Truck Driver - Heavy	\$ 19.49	\$ 4.13	\$ 23.62
Highway Worker/Guardrail Installer	\$ 24.87	\$ 1.36	\$ 26.23	Truck Driver - Light	\$ 24.15	\$ 0.38	\$ 24.53
Hot Top Plant Operator	\$ 23.91	\$ 13.25	\$ 37.16	Truck Driver - Medium	\$ 19.25	\$ 1.09	\$ 20.34
Industrial Truck (Forklift) Operator	\$ 26.83	\$ 3.25	\$ 30.08	Truck Driver - Tractor Trailer	\$ 18.00	\$ 0.00	\$ 18.00

The Laborer classifications include a wide range of work duties. Therefore, if any specific occupation to be employed on this project is not listed in this determination, call the Bureau of Labor Standards at the above number for further clarification.

Welders are classified in the trade to which the welding is incidental.

Apprentices – The minimum wage rate for registered apprentices are those set forth in the standards and policies of the Maine State Apprenticeship and Training Council for approved apprenticeship programs.

Title 26 §1310 requires that a clearly legible statement of all fair minimum wage and benefits rates to be paid the several classes of laborers, workers and mechanics employed on the construction on the public work must be kept posted in a prominent and easily accessible place at the site by each contractor and subcontractor subject to sections 1304 to 1313.

Appeal – Any person affected by the determination of these rates may appeal to the Commissioner of Labor by filing a written notice with the Commissioner stating the specific grounds of the objection within ten (10) days from the filing of these rates.

A true copy

Attest: Scott R. Cotnoir
 Scott R. Cotnoir
 Wage & Hour Director
 Bureau of Labor Standards

Expiration Date: 12-31-2021
 Revised 2-25-2021

SPECIAL PROVISIONS
SECTION 104
Utilities

UTILITY COORDINATION

The contractor has primary responsibility for coordinating their work with utilities after contract award. The contractor shall communicate directly with the utilities regarding any utility work necessary to maintain the contractor’s schedule and prevent project construction delays. The contractor shall notify the resident of any issues.

THE CONTRACTOR SHALL PLAN AND CONDUCT WORK ACCORDINGLY.

MEETING

A Pre-Utility meeting, as defined in Subsection 104.4.6 of the Standard Specifications, **is not** required.

GENERAL INFORMATION

These Special Provisions outline the arrangements that have been made by the Department for utility work to be undertaken in conjunction with this project. The following table identify all known utilities having facilities presently located within the limits of the specified road segment or intending to adjust facilities during this construction project.

Utilities have been notified and shall be furnished a project booklet electronically.

Utility Overview Information				
Utility	Aerial	Subsurface	Contact Person	Contact Phone
Consolidated Communications of Northern New England Company	X		Mike McPherson	991-6725 office
Versant Power	X		Tom Rodgerson	760-2554 office
Spectrum Charter Communications	X		Patrick Hardgrove	253-2443 office
Caribou Utilities District water/sewer		X	Hugh Kirkpatrick	496-0911 office
MaineDOT Electric		X	Ron Cote	446-2305 office

Temporary utility adjustments **are not** anticipated as part of this project. If any unexpected utility relocations become necessary, they shall be scheduled in compliance with Section 104 of the Standard Specifications and shall be performed by the appropriate utility company in conjunction with the work by the Contractor. Should the contractor choose to have any poles temporarily relocated, all work shall be done at the Contractor’s request and expense, with no additional cost or schedule impacts to the Department.

Any adjustments are to be made by the respective utility unless otherwise specified herein.

In order to provide proper fire protection, the existing fire hydrants shall not be disturbed until all necessary work has been accomplished.

Utility working days are Monday through Friday. Times are estimated based on a single crew for each utility. Any times and dates mentioned are **estimates only** and dependent upon favorable weather, working conditions, and freedom from emergencies. The Contractor shall have no claim against the Department if they are exceeded.

The contractor shall notify all utility companies **ten (10) working days** prior to beginning any work on this project.

**** Specific information regarding the line voltage can be requested from Versant Power****

AERIAL

Aerial utility adjustments **are not** anticipated as part of this project. If any unexpected utility relocations become necessary, they shall be scheduled in compliance with Section 104 of the Standard Specifications and shall be done by the utilities in conjunction with the work by the Contractor.

The aerial utilities have existing service lines crossing the highway corridor at intermediate locations. Each of the existing service lines provide a source of power or communication to the surrounding residents.

SUBSURFACE

Subsurface utility adjustments **are not** anticipated as part of this project. If any unexpected utility relocations become necessary, they shall be scheduled in compliance with Section 104 of the Standard Specifications and shall be done by the utilities in conjunction with the work by the Contractor.

Utility Specific Information:

Caribou Utilities District (CUD):

Caribou Utilities District operates/owns the existing water/sewer systems along the short highway segment westerly of the route #89 overpass. These existing subsurface facilities are active and serve the surrounding area at intermediate locations. No adjustments are anticipated for the CUD facilities.

MaineDOT Electrical:

MaineDOT Electrical has subsurface facilities existing at the Caribou connector ramps (46.887615/-68.013866) and the Route #161B/Route #161 intersection (46.886899/-68.043592) in Caribou. The subsurface facilities are active and serve the existing light fixtures that surrounds each of these locations. No adjustments are anticipated for the MaineDOT facilities.

MAINTAINING UTILITY LOCATION MARKINGS

The Contractor shall be responsible for maintaining the buried utility location markings following the initial locating by the appropriate utility or their designated representative.

UTILITY SIGNING

Any utility working within the construction limits of this project shall ensure that the traveling public is adequately protected at all times. All work areas shall be signed, lighted, and traffic flaggers employed as determined by field conditions. All traffic controls shall be in accordance with the latest edition of the Manual on Uniform Traffic Control Devices for Streets and Highways, as issued by the Federal Highway Administration.

SPECIAL PROVISION
SECTION 105
GENERAL SCOPE OF WORK
(Buy America Certification)

105.11 Federal Requirements Add the following as the third and subsequent paragraphs:

“Prior to payment by the Department, the Contractor shall provide a certification from the producer of steel or iron, or any product containing steel or iron as a component, stating that all steel or iron furnished or incorporated into the furnished product was manufactured in the United States in accordance with the requirements of the Buy America provisions of 23 CFR 635.410, as amended. Such certification shall also include (1) a statement that the iron or steel product or component was produced entirely within the United States, or (2) a statement that the iron or steel product or component was produced within the United States except for minimal quantities of foreign steel and iron valued at \$ (actual value).

All manufacturing processes must take place domestically. Manufacturing begins with the initial melting and mixing, and continues through the coating stage. Any process which modifies the chemical content, the physical size and shape, or the final finish is considered a manufacturing process. These processes include rolling, extruding, machining, bending, grinding, drilling, and coating. “Coating” includes epoxy coating, galvanizing, painting, or any other coating that protects or enhances the value of the material.

A Buy America Certification is required from each manufacturer, fabricator, supplier, subcontractor, etc. that meets the “manufacturing” definition above.

Buy America does not apply to raw materials (iron ore and alloys), scrap, pig iron, or processed, pelletized, and reduced iron ore.”

SPECIAL PROVISION 105
CONSTRUCTION AREA

Construction Areas located in the City of Caribou, Towns of Woodland and New Sweden have been established by the Maine Department of Transportation (MDOT) in accordance with provisions of 29-A § 2382 Maine Revised Statutes Annotated (MRSA).

The sections of highway under construction in Aroostook County:

Project 2492300 is on Route 161 beginning in Caribou at the south junction of US Route 1 and extending northwest 9.80 miles to 0.08 of a mile southeast of the Station Road.

Per 29-A § 2382 (7) MRSA, the MDOT may “issue permits for stated periods of time for loads and equipment employed on public way construction projects, United States Government projects or construction of private ways, when within construction areas established by the Department of Transportation. The permit:

A. *Must be procured from the municipal officers for a construction area within that municipality;*

B. *May require the contractor to be responsible for damage to ways used in the construction areas and may provide for:*

(1) Withholding by the agency contracting the work of final payment under contract; or

(2) The furnishing of a bond by the contractor to guarantee suitable repair or payment of damages.

The suitability of repairs or the amount of damage is to be determined by the Department of Transportation on state-maintained ways and bridges, otherwise by the municipal officers;

C. *May be granted by the Department of Transportation or by the state engineer in charge of the construction contract; and*

D. *For construction areas, carries no fee and does not come within the scope of this section.”*

The Municipal Officers for the City of Caribou, Towns of Woodland and New Sweden agreed that an Overlimit Permit will be issued to the Contractor for the purpose of using loads and equipment on municipal ways in excess of the limits as specified in 29-A MRSA, on the municipal ways as described in the “Construction Area.”

As noted above, a bond may be required by the municipality, the exact amount of said bond to be determined prior to use of any municipal way. The MDOT will assist in determining the bond amount if requested by the municipality.

The maximum speed limits for trucks on any town way will be 25 mph (40 km per hour) unless a higher legal limit is specifically agreed upon in writing by the Municipal Officers concerned.

Special Provision
Section 105
General Scope of Work
(Limitations of Operations)

1. Only one paving operation is allowed at one time, excluding hand placed paving, unless otherwise approved by Resident.
2. The Contractor shall plan operations so that the Resident will have sufficient advance notification to provide the necessary inspection and testing. Sufficient notification is considered 48 hours.
3. The Contractor shall provide the Resident with a 48-hour written notice before beginning night work. After receiving this notice, no work is allowed for 48 hours. Once work has been completed, the Contractor shall provide the same notice to return to day work.
4. The Contractor shall not schedule both day work and night work within the same 24-hour period without prior approval by the Resident and 48-hour notice.
5. The Contractor shall request absences at least 72 hours in advance. The Department will review and approve based on existing roadway condition, paving deadlines, adherence to schedule, traffic restrictions, detours, etc. The Contractor shall assure that the roadway surface and signage are maintained for safe passage of the traveling public during any approved absences. The Department will not modify the Contract Completion Date for approved absences.
6. Traffic can travel on milled surfaces on the mainline. After 7 calendar days, the Contractor shall repair any milled areas not covered, in need of extra repair or maintenance (see Special Provision 202) to the satisfaction of the Resident. All work, equipment and materials required to make repairs is at the Contractor's expense. Failure to adequately maintain milled areas will also result in a violation of Special Provision 652. The Contractor shall plan and conduct their work accordingly.
7. Lane closure length will be kept to the minimum required for the shift's operations, not to exceed the maximum allowed by contract.

NOTICE

(COVID-19 Pandemic)

The Department considers the COVID-19 Pandemic an Uncontrollable Event as defined in Section 101.2 of the Department's Standard Specifications.

Accordingly, any documented delay to the project's Critical Path due to COVID-19 related issues, such as impacted workforce, subcontracts, or material supply, will be considered an Excusable Delay as defined in Section 109.5(A)(3) of the Department's Supplemental Specifications.

As an Excusable Delay, the Contractor is entitled to an extension of time provided that other associated notification, documentation, and procedural requirements set forth in the Contract are met.

MaineDOT DBE Project Attainment Target (PAT)
for this Project is 4.44 %

The MaineDOT seeks to meet the specified annual Disadvantaged Business Enterprise (DBE) usage goal set out by 49 CFR 26.45 through the efforts of contractors seeking to employ qualified DBE subcontractors. We seek to meet this goal by race neutral means and do not, at this time, use contract specific requirements for each project. We do however, understand the capacity of Maine's DBE community and the unique characteristics a project may have that would differ from the broad annual goal.

Taking this into consideration, the MaineDOT will review each project and develop an anticipated attainment or Project Attainment Target (PAT) based on several factors that are project specific. Those factors include:

- Scope of Work
- DBE availability according to Specification Item
- Geographic location
- DBE capacity

This PAT is developed to assist contractors to better understand the DBE participation that the MaineDOT can reasonably expect for a specific project. The PAT is NOT a mandate but an assessment of the DBE opportunities that this project could meet or exceed. MaineDOT anticipates that each contractor will make the best effort to reach or exceed the PAT for this project.

SPECIAL PROVISION
SECTION 107
PROSECUTION AND PROGRESS
(Contract Time – Working Days)

This Contract shall be completed within **35** working days. The Contractor may begin work anytime on or after **May 15th** in accordance with Standard Specification 104.4.2 and upon approval of all required submittals. Time charge will commence on the start date or no later than **July 26th**, whichever occurs first.

At least 21 calendar days prior to the desired Begin Construction Date (**and no later than June 15th**), the Contractor shall submit an **electronic copy of their signed request to begin work and the Begin Construction Date**. This signed request shall be sent read receipt through **email** with their **Schedule of Work**, in accordance with Standard Specification 107.4.2, to Shawn.Smith@Maine.gov, Dale.Mayo@Maine.gov, Scott.Bickford@Maine.gov and, Ryan.Sullivan@maine.gov. The Contractor shall notify all utility contacts listed in the 104 Special Provision and provide the utility contacts the submitted schedule of work within 2 calendar days of the schedule of work submittal. **A penalty in the amount of \$500/day will be assessed for each calendar day or partial calendar day beyond June 15th that the schedule of work is not received.** Upon receipt of the schedule of work, a pre-construction meeting will be scheduled.

The Contractor may request to adjust the submitted schedule of work and Begin Construction Date once after the initial submittal. The Department will allow adjustments in the Begin Construction Date of up to seven calendar days if the request is made at least 21 calendar days prior to the updated Begin Construction Date. This signed request shall be sent read receipt through **email** with their **Schedule of Work**, in accordance with Standard Specification 107.4.2, to Shawn.Smith@Maine.gov, Dale.Mayo@Maine.gov, Scott.Bickford@Maine.gov, and, Ryan.Sullivan@maine.gov. The Contractor shall notify all utility contacts listed in the 104 Special Provision and provide the utility contacts the updated schedule of work within 2 calendar days of the request to adjust the Begin Construction Date.

SPECIAL PROVISION
SECTION 107
SCHEDULING OF WORK

Replace Section 107.4.2 with the following:

”107.4.2 Schedule of Work Required Within 21 Days of Contract Execution and before beginning any on-site activities, the Contractor shall provide the Department with its Schedule of Work. The Contractor shall plan the Work, including the activity of Subcontractors, vendors, and suppliers, such that all Work will be performed in Substantial Conformity with its Schedule of Work. The Schedule must include sufficient time for the Department to perform its functions as indicated in this Contract, including QA inspection and testing, approval of the Contractor's TCP, SEWPCP and QCP, and review of Working Drawings.

At a minimum, the Schedule of Work shall include a bar chart which shows the major Work activities, milestones, durations, **submittals and approvals**, and a timeline. Milestones to be included in the schedule include: (A) start of Work, (B) beginning and ending of planned Work suspensions, (C) Completion of Physical Work, and (D) Completion. If the Contractor Plans to Complete the Work before the specified Completion date, the Schedule shall so indicate.

Any restrictions that affect the Schedule of Work such as paving restrictions or In-Stream Work windows must be charted with the related activities to demonstrate that the Schedule of Work complies with the Contract.

The Department will review the Schedule of Work and provide comments to the Contractor within 20 days of receipt of the schedule. The Contractor will make the requested changes to the schedule and issue the finalized version to the Department.”

SPECIAL PROVISION
SECTION 107
TIME
(Liquidated Damages)
(Working Days)

107.7.2 SCHEDULE OF LIQUIDATED DAMAGES

Revise this section by removing the numbers in the chart and replace with the following:

Original Contract Amount

From More Than	to	To and Including	Amount of Liquidated Damages per Working Day
\$ 0	to	\$ 100,000.00	\$400.00
\$ 100,000.00	to	\$ 250,000.00	\$800.00
\$ 250,000.00	to	\$ 500,000.00	\$1,000.00
\$ 500,000.00	to	\$1,000,000.00	\$1,250.00
\$1,000,000.00	to	\$2,000,000.00	\$1,600.00
\$2,000,000.00	to	\$4,000,000.00	\$2,000.00
\$4,000,000.00	and	More	\$3,350.00

SPECIAL PROVISIONS
SECTION 202
REMOVING STRUCTURES AND OBSTRUCTIONS
(Removing Pavement Surface – Medium Cut Drum)

The March 2020 Revision of the Standard Specifications, Section 202-Removing Structures and Obstructions, subsection 202.061-Removing Pavement Surface, has been removed and replaced in its entirety by the following:

202.061 Removing Pavement Surface The equipment for removing the bituminous surface shall be a power operated milling machine or grinder capable of removing bituminous concrete pavement to the required depth, transverse cross slope, and profile grade using an automated grade and slope control system. The controls shall automatically increase or decrease the pavement removal depth as required, and readily maintain desired cross slope, to compensate for surface irregularities in the existing pavement course. The equipment shall be capable of accurately establishing profile grades by referencing from a fixed reference such as a 30 foot minimum contact ski (floating beam), 24 foot non-contact ski (floating beam) with 3 or more sensors; or 3 non-contact sensors directly affixed at the fore, mid, and aft points of the milling machine. Systems designed to incorporate a contact sensor located at the mid-point of the milling machine in lieu of the non-contact sensor will be permitted. Grade control sensors shall all be located on the same side. A single sensor, contact or otherwise, shall not be permitted unless otherwise approved by the Department.

The rotary drum shall be a minimum of 7 feet in width and utilize carbide tip tools spaced not more than 5/16 inches (8mm) apart and a minimum triple wrap configuration. The difference in height from the top of any ridge to the bottom of the groove adjacent to that ridge shall not exceed 1/8 inch. The forward speed of the milling machine shall be adjusted to produce a milled surface meeting the groove spacing, groove depth, and surface tolerance requirements of this specification. The tools on the revolving cutting drum must be continually maintained and shall be replaced as warranted to provide a uniform pavement texture. The Department may evaluate the texture of the milled surface for information purposes by performing the Sand Patch test according to ASTM E 965.

The Contractor shall locate and remove all objects in the pavement through the work area that would be detrimental to the milling or grinding machine. Any structures or obstructions left within the travel lane or shoulders shall have tapers installed according to Standard Detail 202(01). The finished milled surface will be inspected before being accepted, and any deviations in the profile exceeding 1/2 inch under a 16 foot string line or straightedge placed parallel to the centerline will be corrected. Any deviations in the cross-slope that exceed 1/8 inch under a 10 foot string line or straightedge placed transversely to centerline will be corrected. All corrections will be made with approved methods and materials. Any areas that require corrective measures will be subject to the same acceptance tolerances. Excess material that becomes bonded to the milled surface will be removed to the Resident's satisfaction before the area is accepted.

On roadways with adjoining lanes carrying traffic, the Contractor shall remove the pavement surface in each lane per the conditions in Table 1, unless otherwise noted by the Department in Special Provision, Section 105 – Limitations of Operations.

TABLE 1: MILLING CONDITIONS FOR ADJOINING LANES

Depth (At Centerline)	Milling Conditions
Vertical Longitudinal Joint	
¾" and less	The Contractor may remove the pavement on a single travel lane width for each production day.
1" to 1 ¼"	The Contractor may remove the pavement on a single travel lane width for each production day and will be required to mill the adjacent section of travel lane before weekend or holiday suspension.
1 ½" to 2"	The Contractor may remove the pavement on a single travel lane width for each production day and will be required to mill the adjacent section of travel lane before the end of the following calendar day.
Greater than 2"	The Contractor shall remove the pavement over the full width of the traveled way section being milled that day.
12:1 Tapered Centerline Joint	
1 ½" to 2"	The Contractor may remove the pavement on a single travel lane width for each production day and will be required to mill the adjacent section of travel lane before weekend or holiday suspension. A maximum unmatched centerline joint length of 0.5 miles will be permitted over the weekend.
Greater than 2"	The Contractor shall remove the pavement on a single travel lane width for each production day and will be required to mill the adjacent section of travel lane before the end of the following calendar day.

The Contractor will be required to remove the pavement over the full width of the mainline traveled way, regardless of highway type, cut depth, or longitudinal joint type prior to Memorial Day, July 4th, Labor Day, suspensions exceeding three days, or other dates as specified by Special Provision, Section 105 – Limitations of Operations.

The Contractor will also be responsible for installing additional warning signage that clearly defines the centerline elevation differential hazard. Unless otherwise addressed in the contract, the Contractor shall install additional centerline delineation such as a double RPM application, or temporary painted line. The Traffic Control Plan shall be amended to include this option and the additional requirements. All signs and traffic control devices will conform to Section 719.01, and Section 652, and will be installed prior to the work, at a maximum spacing of 0.50 mile for the entire length of effected roadway section. If this option is utilized, all additional signing, labor, traffic control devices, or incidentals will not be paid for directly, will be considered incidental to the appropriate 652 items.

On roadways with immediately adjacent shoulders, the Contractor shall remove the pavement surface in each lane per the conditions in Table 2, unless otherwise noted by the Department in Special Provision, Section 105 – Limitations of Operations.

TABLE 2: MILLING CONDITIONS FOR THE EDGE OF TRAVELED WAY

Depth (At Edge of Traveled Way)	Conditions
1” or less	The Contractor may leave a vertical edge joint exposed indefinitely.
Greater than 1” to 2”	The Contractor may leave a vertical edge joint exposed for up to 21 days after milling is performed. The Contractor shall treat vertical edge joints exposed beyond 21 days per the criteria below.
Greater than 2”	The Contractor shall treat vertical edge joints exposed per the criteria below.

When required by Table 2, the Contractor shall treat vertical edge joints through one of the options below:

1. The vertical edge shall be tapered to a zero edge by means of milling a 12:1 transition from the edge of traveled way onto the shoulder before opening the lane to traffic. Tapers shall be removed to form a vertical edge prior to the placement of the new pavement course. No additional payment will be made for tapers, or taper removal.
2. An additional 2 feet of pavement shall be removed from the shoulder to eliminate the vertical edge at the edge of travelway before opening the lane to traffic. Unless otherwise authorized by the Department, no additional payment will be made for the additional milling.
3. A pavement layer shall be placed to reduce the vertical edge to 1 inch or less before opening the lane to traffic.

As a minimum, the use of temporary painted line, or RPMs placed along the edge of traveled way at 200 foot intervals is required for all elevation differentials. When pavement milling is extended into the shoulder (including milled tapers), appropriate channelization devices shall be placed 2 feet outside the edge of the vertical face at intervals not exceeding 600 feet, and RPMs shall be placed on the remaining pavement surface along the vertical edge at 200 foot intervals. Uneven pavement signs shall be placed at a maximum spacing of ½ mile when any pavement milling operations leaves an exposed uneven pavement surface.

Weepers shall be ground across the full width sections adjacent shoulders or remaining pavement surface matching the milled travel way or shoulder milled depth to minimize water ponding in any lanes carrying traffic. Weepers shall typically be 18 – 24” inches in width, installed along each lane, at a frequency of approximately one per half mile at locations as directed by the Resident or in areas that will provide drainage for the milled areas. Installation of weepers will not be paid for directly but will be considered incidental to the contracts pavement removal item. The replacement of mix in the weeper locations shall be performed concurrently within the pavement placement operation closure using the appropriate HMA item produced for the Contract or a MaineDOT approved 9.5mm HMA. There will be no separate payment for repaving the weeper locations as they are considered incidental to the square yard price of the contracts pavement removal item.

Any areas of concern, such as de-lamination or pot-holing shall be identified on a continuous basis as milling progresses. Proper corrective action will be determined by the Resident and paid for under the appropriate contract items, and if required, completed prior to opening lane to traffic. Any issues that arise **up to 21 calendar days** after being milled will be the responsibility of the MaineDOT unless otherwise noted in Special Provision Section 105 – Limitations Of Operations.

Basis of Payment

The square yard or hourly rental contract price will be full compensation for mobilizing to the site, de-mobilizing from the site, labor, supervision, cleaning of the milled surface, and all other incidentals required to complete the work. Hauling and stockpiling of the material will not be paid for directly, but will be considered incidental to the milling items.

Square Yard: Payment will be made at the contract unit price for the number of square yards removed.

Hourly: Payment will be made at the contract unit price for the number of hours of operation removing pavement surface as directed by the Resident. The equipment used for pavement removal shall be operated at the minimum speed of 50 fpm, unless the Resident directs otherwise for milled surface quality reasons, or traffic control limitations impact pavement removal operations, or site conditions make operations at the prescribed rate unreasonable. Trimming to create a vertical face along curb line, guardrail, or around structures will be considered incidental to the 202.202 items. Additional trimming beyond the incidental work described will be paid under the appropriate rental items as listed in the Contract.

<u>Pay Item</u>	<u>Pay Unit</u>
202.2023 Removing Pavement Surface - Medium Cut Drum	S.Y.
202.20231 Removing Pavement Surface - Medium Cut Drum (Hourly)	Hour

SECTION 401 - HOT MIX ASPHALT PAVEMENT

401.01 Description The Contractor shall furnish a uniformly blended, homogeneous mixture placed as one or more courses of Hot Mix Asphalt Pavement (HMA) on an approved base in accordance with the contract documents and in reasonably close conformity with the lines, grades, thickness, and typical cross sections shown on the plans or established by the Resident. The Department will accept this work under Quality Assurance provisions, in accordance with these specifications and the requirements of Section 106 – Quality, the provisions of AASHTO M 323 except where otherwise noted in sections 401 and 703 of these specifications, and the MaineDOT Policies and Procedures for HMA Sampling and Testing.

401.02 Materials Materials shall meet the requirements specified in Section 700 - Materials:

Asphalt Cement	702.01
Aggregates for HMA Pavement	703.07
RAP for HMA Pavement	703.08
HMA Mixture Composition	703.09

401.03 Composition of Mixtures The Contractor shall compose the Hot Mix Asphalt Pavement with aggregate, Performance Graded Asphalt Binder (PGAB), approved antistrip, warm mix additive, and/or mineral filler if required. HMA shall be designed and tested according to AASHTO R 35 and the volumetric criteria in Table 1. The Contractor shall size, uniformly grade, and combine the aggregate fractions in proportions that provide a mixture meeting the grading requirements of the Job Mix Formula (JMF). Unless otherwise noted in Special Provision 403 - Hot Mix Asphalt Pavement, the design, verification, Quality Control, and Acceptance tests for this mix will be performed at 65 gyrations. **TABLE 1: VOLUMETRIC DESIGN CRITERIA**

Design ESAL's (Millions)	Required Density (Percent of G _{mm})			Voids in the Mineral Aggregate (VMA) (Minimum Percent)					Voids Filled with Binder (VFB) (Minimum %)	Fines/Eff. Binder Ratio
				Nominal Maximum Aggregate Size (mm)						
	N _{initial}	N _{design}	N _{max}	25.0	19.0	12.5	9.5	4.75		
< 3.0	≤90.5									
3 to <10	≤89.0	96.0	≤98.0	13.0	14.0	15.0	16.0	16.0	65-80*	0.6-1.2
≥ 10										

*For 9.5 mm nominal maximum aggregate size mixtures, the maximum VFB is 82. For 4.75 mm nominal maximum aggregate size mixtures, the maximum VFB is 84.

The Contractor shall submit a JMF to the Department for each mixture to be supplied. The JMF will be approved by the Department in accordance with the MaineDOT HMA Policies and Procedures for HMA Sampling and Testing Manual. At the time of JMF submittal, the Contractor shall identify and make available the stockpiles of all proposed aggregates at the plant site. There must be a minimum of 150 ton for coarse aggregate stockpiles and 75 ton for fine aggregate stockpiles before the JMF may be submitted. The Contractor shall provide aggregate samples to the Department unless otherwise required. The Contractor shall also make available to the Department the PGAB proposed for use in the mix in sufficient quantity to test the properties of the asphalt and to produce

samples for testing of the mixture. The first day’s production shall be monitored, and the approval may be withdrawn if the mixture exhibits undesirable characteristics such as checking, shoving or displacement. The Contractor shall be allowed to submit aim changes for a JMF as outlined in the MaineDOT HMA Policies and Procedures for HMA Sampling and Testing Manual: Mix Design Approval Section.

The Contractor shall submit a new JMF for approval each time a change in material source or materials properties is proposed. The same approval process shall be followed. The cold feed percentage of any aggregate may be adjusted up to 10 percentage points from the amount listed on the JMF, however no aggregate listed on the JMF shall be eliminated. The cold feed percentage for RAP may be reduced up to 10 percentage points from the amount listed on the JMF and shall not exceed the percentage of RAP approved in the JMF or for the specific application under any circumstances.

401.031 Warm Mix Technology The Contractor may place Hot Mix Asphalt Pavement produced with an accepted WMA technology if approved by the Department. Methods or technologies shall generally be at the Contractors option, but will be limited to proven, Agency and Industry accepted practice. Mixture production, placement and volumetric testing details, including temperatures, shall be included in the project specific QCP, and submitted to the Department for approval prior to any work.

401.04 Temperature Requirements The temperature of the mixture shall conform to the tolerances in Table 2 as measured at the truck at the mixing plant and at the paver unless otherwise authorized by the Department.

TABLE 2: ALLOWABLE TEMPERATURE RANGES

PGAB Grade(s)	Temperature Range (°F)
PG58-28 / PG64-28	275-325
PG64E-28 / PG70E-28	285-335

401.05 Performance Graded Asphalt Binder The Contractor shall utilize either a PG58-28, PG64-28, PG64E-28, PG70E-28, or other grade as specified in the 403 Special Provision. The Contractor shall utilize a PG64-28 if no liquid grade is specified within the 403 Special Provision.

401.06 Weather and Seasonal Limitations The State is divided into two paving zones as follows:

- a. Zone 1 Areas north of US Route 2 from Gilead to Bangor and north of Route 9 from Bangor to Calais.
- b. Zone 2 Areas south of Zone 1 including the US Route 2 and Route 9 boundaries.

TABLE 3: SEASONAL AND TEMPERATURE LIMITATIONS

Use	Minimum Ambient Air Temperature	Zone 1 Allowable Placement Dates	Zone 2 Allowable Placement Dates
Surface course (travelway & adjacent shoulders) less than 1 in. thick placed during conditions defined as “night work”	50°F	June 1 to Saturday following September 1	
Surface course (travelway & adjacent shoulders) less than 1 in. thick	50°F	May 15 to Saturday following September 15	
Travelway surface course greater than or equal to 1 in. thick	50°F	May 1 to Saturday following October 1	April 15 to Saturday following October 15
HMA for surface course on bridge decks	50°F	May 1 to Saturday following October 1	April 15 to Saturday following October 15
HMA for base or shim course on bridge decks	50°F	April 15 to November 15	
HMA for use other than travelway surface course	40°F	April 15 to November 15	
HMA for curb, driveways, sidewalks, islands, or other incidentals	40°F	N/A	N/A
HMA produced with an approved WMA technology for base or shim course	35°F	April 15 to November 15	

The ambient air temperature shall be determined by an approved thermometer placed in the shade at the paving location. Unless otherwise specified, the Contractor shall not place Hot Mix Asphalt Pavement on a wet or frozen surface regardless of the ambient air temperature. The Hot Mix Asphalt Pavement produced with an approved WMA technology shall meet the requirements of section 401.04 - Temperature Requirements, unless otherwise approved by the Department. For the purposes of this Section, the traveled way includes truck lanes, ramps, approach roads and auxiliary lanes.

401.07 Hot Mix Asphalt Plant

401.071 General Requirements HMA plants shall conform to AASHTO M 156, Standard Specification for Requirements for Mixing Plants for Hot-Mixed, Hot-Laid Bituminous Paving Mixtures with exception of Section 4.2.1, 4.2.2, 4.3.4, 4.3.5, and 4.12.2.

All HMA plants will be inspected annually by the Department prior to producing HMA for Department projects. The Contractor shall provide the Department at least 72 hours’ notice that the plant is ready for inspection. The Contractor shall equip the plant with ladders and platforms that are accessible and safe to obtain samples of PGAB, aggregate and mix from the relevant tanks, collector belts and haul units. Silo storage time of mixtures shall not exceed 36 hours.

401.072 Stockpiles The Contractor shall provide sufficient space for stockpiles and maintain a minimum of supply for 2 days production of all aggregate products used in MaineDOT approved mix designs currently under production. A minimum stockpile supply of 100 ton (70 yards) shall be maintained at all times. The Contractor shall construct stockpiles to prevent intermingling and to

minimize segregation. All stockpiles used in MaineDOT mixes shall be identified with weatherproof signs at least 12" high and 24" wide, with reflective lettering at least 2" high.

401.073 Cold Feeds Cold Feed Bins will have bin dividers to keep aggregate products separated. Adequate means must be provided for obtaining samples of the combined flow of all Cold feed bins.

401.074 Dryer Dryer shall be capable of heating aggregate to required mixing temperature and shall be in good operation and condition. Dryer shall be subject to annual inspection prior to start-up. The Contractor shall dry and heat the aggregates for the HMA to the required temperature, adjusting flames to avoid damaging the aggregates. The Contractor shall provide the Department a minimum period of 72 hours to inspect the dryer and provide at least 24 hours' notice that the dryer is ready for inspection.

401.075 Asphalt Binder The plant shall include a heating system and insulation to maintain the asphalt binder at a uniform temperature for proper mixing and compaction. A thermometer shall be provided in the asphalt binder line. No direct flame may come in contact with tank. A sampling valve shall be provided in the circulation line downstream of any binder additive used unless otherwise approved by the Department. The Contractor shall drain down the asphalt as low as safely possible in any tank that will be switched to a new source or grade prior to adding the new PGAB.

401.076 Additives Additives (WMA, anti-strip, etc.) introduced into the binder at the HMA plant shall be introduced per the supplier's recommendations and shall be approved by the Department. The system for introducing additives shall be interlocked with the aggregate feed or weigh system to maintain correct proportions for all production rates and batch sizes. Additive introduction systems shall be controlled by a proportioning device to the amount required on the JMF plus or minus 0.1% of the target. Additive introduction systems shall be interlocked with the plant and the recordation (batch tickets or drum recordation) shall display the additive and the weight and percentage added. A means for sampling the PG binder with additive introduced will be provided. The sampling point shall be after the additive is mixed with the PGAB before entering the drum or mixer unit.

401.077 Batch Plants

Hot Bins Hot bins shall provide uniform continuous operation and be in good working condition. The plant shall be able to provide samples of hot bins upon request. Overflow shall be provided for each hot bin. Hot bin gates shall close without leaking. Bin walls must prevent intermingling between bins. Each hot bin shall have low level indicators which will alert the operator when the bin is empty.

Mixer Unit Clearance between blades and liner shall be 1" maximum, unless the aggregate exceeds 1 ¼" then the clearance shall be 1 ½". The spray bar length shall be at least 75% of the mixer length. The mixer unit shall be a twin pug mill-type mixer capable of mixing continuously for at least 45 seconds after all materials have been introduced into the mixer. The blades in the mixer shall be capable of producing a homogenous mixture. If the mixer is not enclosed, it shall be equipped with an adjustable hood to prevent loss of dust by dispersion. The mixer unit shall be subject to annual inspection prior to removal of safety features and being readied for service. The Contractor shall provide the Department the opportunity to inspect the mixer unit prior to the annual inspection. The Contractor shall provide the Department a minimum period of 72 hours to inspect the mixer unit and provide at least 24 hours' notice that the mixer unit is ready for inspection.

Mineral Filler Mineral filler and fiber shall utilize separate bins and feed systems to store and proportion the required quantity into the mixture. The feed systems shall be accurate to no more than 10% of the required weight with a convenient and accurate means of calibration. Mineral filler and fiber shall be introduced in the weigh hopper and uniformly distributed prior to the injection of the asphalt binder.

Automation The HMA batch plant shall automatically batch, mix and discharges mixes. The batch plant shall accurately proportion the various materials in the proper order by weight. The entire batching and mixing cycle shall be continuous and shall not require any manual operations. The batch plant shall use auxiliary interlock circuits to trigger an audible alarm whenever an error exceeding the acceptable tolerance occurs. Along with the alarm, the printer shall print an asterisk on the delivery slip in the same row containing the out-of-tolerance weight. The automatic proportioning system shall be capable of consistently delivering material within the full range of batch sizes. When RAP is being used, the plant must be capable of automatically compensating for the moisture content of the RAP.

The HMA batch plant shall be operated within the following tolerances:

Each aggregate component	+/- 1.5% cumulative, per bin
Mineral Filler	+/- 0.5%
Bituminous Material	+/- 0.1%
Zero return (aggregate)	+/- 0.5%
Zero Return (AC)	+/- 0.1%
Additives	+/- 0.1%

Recordation All plants shall be equipped with an approved digital recording device. The printer shall mark any weight on the ticket that exceeds tolerance. The delivery slip shall contain information required under Section 108.1.3 - Provisions Relating to Certain Measurements, Mass and paragraphs a, b, and c of Section 401.078.

401.078 Drum Plants

Cold Feeds and Delivery System A scalper screen shall be used to remove oversize material. The accuracy of the belt scale shall be within +/- 1.0% of the actual weight being measured. The plant shall be capable of correcting for aggregate moisture. Mineral filler and fiber shall utilize separate bin(s) and feeder systems to store and proportion the required quantity into the mixture. The feed systems shall be accurate to no more than +/- 10% of the required weight with a convenient and accurate means of calibration. The plant shall be equipped with a single control to change all feed rates. Mineral filler and fiber shall be introduced such that dry mixing is accomplished no less than 18 inches prior to the injection of the asphalt binder. The Contractor shall ensure that the mineral filler does not become entrained in the exhaust stream of the dryer.

Binder System The flow of asphalt binder shall adjust automatically with dry aggregate weights. The Department will conduct an asphalt flow meter check annually and after each change of plant location. The flow meter check must be performed prior to producing mix for Department projects. The plant must be configured to provide a convenient means to check accuracy of the flow meter. The flow meter will be considered accurate if the measured weight is within 1% of actual weight.

Drum Mixer The plant shall be equipped with a diversion system where mix can be diverted at startup/shutdown and any time. The drum mixer shall be subject to annual inspection prior to removal of safety features and being readied for service. The Contractor shall provide the Department a minimum period of 72 hours to inspect the drum mixer while providing at least 72 hours' notice that the drum mixer is ready for inspection.

Recordation An approved automatic ticket printer system shall be used to print delivery slips. The requirements for delivery slips for payment of materials measured by weight, as given in the following Sections, shall be waived: 108.1.3 a., 108.1.3 b., 108.1.3 c., and 108.1.3 d. The automatic printed ticket will be considered as the Weight Certificate. The dry aggregate weights and binder flow shall be recorded as well as mineral filler and all binder additives. The recordation of materials shall be printed a minimum of every ten minutes while in production.

The requirements of Section 108.1.3 f. - Delivery Slips, shall be met by the delivery slip printed by the automatic system, which accompanies each truckload, except for the following changes:

- a. The quantity information required shall be individual weights of each batch or total net weight of each truckload.
- b. Signatures (legible initials acceptable) of Weighmaster (required only in the event of a malfunction as described in 401.074 c.).
- c. The MaineDOT designation for the JMF.

401.079 Scales and Weight Checks Scales shall meeting the requirements of Section 108 - Payment. The scales shall be inspected and sealed by the State Sealer (or approved alternative) as often as the Department deems necessary to verify their accuracy. Plant scales shall be checked prior to the start of the paving season, and each time a plant is moved to a new location. Subsequent checks will be made as determined by the Resident. The Contractor will have at least ten 50 pound masses for scale testing at batch plants. At Contractor's option, the Contractor can use one single test weight that has been checked on sealed scales. This weight shall be 1,000 lbs. or greater. At least twice during each 5 days of production either of the following checks will be performed:

- a. A loaded truck may be intercepted and weighed on a platform scale that has been sealed by the State Sealer of Weights and Measures within the past 12 months. The inspector will notify the producer to take corrective action on any discrepancy over 1.0%. The producer may continue to operate for 48 hours under the following conditions.
 1. If the discrepancy does not exceed 1.5%; payment will still be governed by the printed ticket.
 2. If the discrepancy exceeds 1.5%, the plant will be allowed to operate as long as payment is determined by truck platform scale net weight.

If, after 48 hours the discrepancy has not been addressed and reduced below 1.0%, then plant operations will cease. Plant operation may resume after the discrepancy has been brought within 1.0%.

- b. Where platform scales are not readily available, a check will be made to verify the accuracy and sensitivity of each scale within the normal weighing range and to assure that the interlocking devices and automatic printer system are functioning properly. If platform scales are not readily

available, a weight with a known mass-verified and sealed annually by a licensed scale company, may be used by hanging weight from silo or surge hopper, at lower middle and upper third levels upon request to verify scale accuracy.

d. In the event of a malfunction of the automatic printer system, production may be continued without the use of platform truck scales for a period not to exceed the next two working days, providing total weights of each batch are recorded on weight tickets and certified by a Licensed Public Weighmaster.

401.08 Hauling Equipment Units hauling HMA shall have tight, clean, and smooth metal bodies, which have been thinly coated with a small amount of approved release agent to prevent the mixture from adhering to the bodies. Release agents that dissolve or strip asphalts, including diesel fuel, will not be allowed.

All mix haul units shall have a cover of water repellent material capable of heat retention, which completely covers the mixture. The cover shall be securely fastened on the truck, unless unloading. Haul units shall have an opening on both sides near the midpoint of the body, at least 12 in above the bed, which will accommodate a thermometer stem.

401.09 Pavers The Contractor shall use pavers meeting the requirements of this section unless otherwise authorized by the Department. Pavers shall meet the requirements of Table 4: Paver Requirements.

TABLE 4: PAVER REQUIREMENTS

Use	Paver Requirement
Traveled Way & Auxiliary Lanes	Equipped with a 10 ft minimum main screed with activated extensions. The minimum tractor weight shall be 30,000 pounds.
	Equipped with automatic grade and slope controls that automatically adjust the screed and increase or decrease the layer thickness to compensate for irregularities in the preceding course. The controls shall maintain the proper transverse slope and be readily adjustable so that transitions and superelevated curves can be properly paved. The controls shall operate from a fixed or moving reference such as a grade wire or ski type device (floating beam) with a minimum length of 30 ft, a non-contact grade control with a minimum span of 24 ft, except that a 40 ft reference shall be used on interstate and divided highway projects.
All HMA Placement	Self-contained, self-propelled units of sufficient class and size to place Hot Mix Asphalt Pavement in full lane widths specified in the contract on the main line, shoulder, or similar construction.
	Equipped with a free-floating activated heated main screed with activated extensions. Pavers with extendible screeds shall have auger extensions and tunnel extenders as per the manufacturer’s recommendations, a copy of which shall be available if requested.
	Equipped with a receiving hopper with sufficient capacity for a uniform spreading operation and a distribution system to place the mixture uniformly, without segregation in front of the screed.
	Operated in such a manner as to produce a visually uniform surface texture and a thickness within the requirements of Section 401.11 - Surface Tolerances. The screed assembly shall produce a finished surface of the required evenness and texture without tearing, shoving, or gouging the mixture.

The Contractor shall have the paver at the project site sufficiently before the start of paving operations to be inspected and approved by the Department. The Contractor shall repair or replace any paver found worn or defective, either before or during placement, to the satisfaction of the Department. Pavers that produce an unevenly textured or non-uniform mat will be repaired or replaced before continuing to place HMA on MaineDOT projects. On a daily basis, the Contractor shall perform density testing across that mat as detailed in Section 401.191 Quality Control - Method A, B & C.

401.10 Rollers Rollers shall be static steel, pneumatic tire, oscillatory, or approved vibrator type. Rollers shall be in good mechanical condition, capable of starting and stopping smoothly, and be free from backlash when reversing direction. Rollers shall be equipped and operated in such a way as to prevent the picking up of hot mixed material by the roller drums or tires. Crushing of the aggregate or displacement of the HMA during rolling will not be permitted. Any HMA Pavement that becomes loose, broken, contaminated, shows an excess or deficiency of PGAB, or is in any other way defective shall be removed and replaced at no additional cost with fresh material which shall be immediately compacted to conform to the adjacent area.

The Contractor shall repair or replace any roller found to be worn or defective, either before or during placement, to the satisfaction of the Department. Rollers that produce grooved, unevenly textured or non-uniform mat will be repaired or replaced before continuing to place HMA. The type of rollers to be used and their relative position in the compaction sequence shall generally be the Contractor's option unless otherwise specified in the contract, provided specified density is attained and with the following requirements:

- a. On variable-depth courses, the first lift of pavement over gravel, reclaimed pavement, on irregular or milled surfaces, or on bridges, at least one roller shall be 16 ton pneumatic-tired. Pneumatic-tired rollers shall be equipped with skirting to minimize the pickup of HMA materials from the paved surface. When required by the Resident, the roller shall be ballasted to 20 ton.
- b. Compaction with a vibratory or steel wheel roller shall precede pneumatic-tired rolling, unless otherwise authorized by the Department.
- c. Vibratory rollers shall not be operated in the vibratory mode on bridge decks.
- d. Any method, which results in cracking or checking of the mat, will be discontinued and corrective action taken.
- e. The use of an oscillating steel roller shall be required to compact all mixtures placed on bridge decks.

The maximum operating speed for a steel wheel or pneumatic roller shall not exceed the manufacturer's recommendations, a copy of which shall be available if requested.

401.11 Surface Tolerances The Department will check the following surface tolerances:

- a.) Longitudinally: The pavement surface profile shall be free of deviations in excess of +/- ¼ inches from the required pavement surface profile grade. To verify the surface tolerance a straight plane shall be established using 16 foot straight edge or a taught string line placed parallel to the direction of travel and checked continuously across the width of the lane.
- b.) Transversely: The pavement surface profile shall be free of deviations in excess of 0 inches below and ¼ inches above the required cross-sectional profile grade. To verify the surface tolerance a straight plane shall be established using a 10 foot straight edge or taught string line

placed perpendicular to the direction of travel and checked continuously along the length of the lane.

The Contractor shall correct defective areas by removing defective work and replacing it with new material as directed by the Department. The Contractor shall furnish a 10 foot straightedge for the Department's use.

401.12 Preparation of Existing Surface The Contractor shall thoroughly clean the surface upon which Hot Mix Asphalt Pavement is to be placed of all objectionable material. When the surface of the existing base or pavement is irregular, the Contractor shall bring it to uniform grade and cross section. All surfaces shall have a tack coat applied prior to placing any new HMA course. Tack coat shall conform to the requirements of Section 409 – Bituminous Tack Coat, Section 702 – Bituminous Material, and all applicable sections of the contract.

401.13 Spreading and Finishing On areas where irregularities or unavoidable obstacles make the use of mechanical spreading and finishing equipment impracticable, the Contractor shall spread, rake, and lute the HMA with hand tools to provide the required compacted thickness. Release agents that dissolve or strip asphalts, including diesel fuel, will not be allowed. On roadways with adjoining lanes carrying traffic, the Contractor shall place each course per the conditions in Table 5, unless otherwise noted by the Department in Section 403 - Hot Mix Asphalt Pavement.

TABLE 5: PLACEMENT CONDITIONS FOR ADJOINING LANES

Depth (at centerline)	Placement Conditions
Vertical Longitudinal Joint	
¾" and less (incl. shim)	The Contractor may place the HMA course over the full single travel lane width for each production day.
1" to 1 ¼"	The Contractor may place the HMA course over the full single travel lane width for each production day and will be required to place a matching course of HMA over the adjacent section of travel lane before weekend or holiday suspension.
1 ½" to 2"	The Contractor may place the HMA course over the full single travel lane width for each production day and will be required to place a matching course of HMA over the adjacent section of travel lane before the end of the following calendar day.
Greater than 2"	The Contractor shall place each course over the full width of the traveled way section being paved that day.
Notched-Wedge Longitudinal Joint	
1 ½" to 2"	The Contractor may place the HMA course over the full single travel lane width for each production day and will be required to place a matching course of HMA over the adjacent section of travel lane before weekend or holiday suspension. A maximum unmatched centerline joint length of 0.5 miles will be permitted over the weekend.
Greater than 2"	The Contractor may place the HMA course over the full single travel lane width for each production day and will be required to place a matching course of HMA over the adjacent section of travel lane before the end of the following calendar day.

The Contractor shall place the specified course over the full width of the mainline traveled way being paved, regardless of use, depth, or longitudinal joint type prior to Memorial Day, July 4th, Labor Day, paving suspensions exceeding three days, or other dates as specified by special provision.

The Contractor shall install additional warning signage that clearly defines the centerline elevation differential hazard. Unless otherwise addressed in the contract, the Contractor shall install additional centerline delineation such as a double application of raised pavement markers at 100 foot intervals, or temporary painted line. For any exposed vertical edge between the shoulder and traveled way, at a minimum, the use of temporary painted line, or RPMs placed along the edge of traveled way at 200 foot intervals is required. The Traffic Control Plan shall be amended to include this option and the additional requirements. All signs and traffic control devices will conform to Section 719.01, and Section 652, and will be installed prior to the work, at a maximum spacing of 0.50 mile for the entire length of effected roadway section. If this option is utilized, all additional signing, labor, traffic control devices, or incidentals will not be paid for directly, will be considered incidental to the appropriate 652 items.

401.14 Hot Mix Asphalt Placement on Bridge Decks Hot mix asphalt pavement placed on bridges shall also conform to Section 508.04 and the following requirements.

- a. The minimum production and placement temperature for the Hot Mix Asphalt placed over membrane shall conform to the manufacturer's recommendations.
- b. The bottom course shall be placed with an approved rubber mounted paver of such type and operated in such a manner that the membrane waterproofing will not be damaged in any way.
- c. The top course shall not be placed until the bottom course has cooled sufficiently to provide stability.
- d. The Contractor will not be required to cut sample cores from the compacted pavement on the bridge deck, unless otherwise directed by Special Provision.
- e. After the top course has been placed, the shoulder areas shall be sealed 3 ft wide with two applications of an emulsified bituminous sealer meeting the requirements of Section 612.03 – Sealing and Section 702.12 - Emulsified Bituminous Sealing Compound. The first application shall be pre-mixed with fine, sharp sand, similar to mortar sand, as needed to fill all voids in the mix in the area being sealed. The second application may be applied without sand. The sealer shall be carried to the curb at the gutter line in sufficient quantity to leave a bead or fillet of material at the face of the curb. The area to be sealed shall be clean, dry and the surface shall be at ambient temperature. The furnishing and applying of the required quantity of sealer for the bridge shoulder areas shall be incidental to placing the hot mix asphalt pavement.
- f. The area between the edge of the membrane and the vertical surface shall be completely sealed with hot-applied rubberized asphalt material, meeting the requirements of Type 4 crack seal; shall be applied to form a complete seal between the membrane and the vertical surface and shall extend up the vertical surface to within ½ inch of the top of the HMA wearing surface. This work shall be considered incidental to the contract pavement items unless 508 membrane items are included in the contract.

401.15 Compaction Immediately after the Hot Mix Asphalt Pavement has been spread, struck off, and any surface irregularities adjusted, the Contractor shall thoroughly and uniformly compact the HMA by rolling.

The Contractor shall roll the surface when the mixture is in the proper condition and when the rolling does not cause undue displacement, cracking, or shoving. The Contractor shall prevent adhesion of the HMA to the rollers or vibrating compactors without the use of fuel oil or other petroleum-based

release agents. Solvents designed to strip asphalt binders from aggregates will not be permitted as release agents on equipment, tools, or pavement surfaces.

The Contractor shall immediately correct any displacement occurring as a result of the reversing of the direction of a roller or from other causes to the satisfaction of the Department. Any operation other than placement of variable depth shim course that results in breakdown of the aggregate shall be discontinued. Any new pavement that shows obvious cracking, checking, or displacement shall be removed and replaced for the full lane width as directed by the Resident at no cost to the Department.

Along forms, curbs, headers, walls, and other places not accessible to the rollers, the Contractor shall thoroughly compact the HMA with mechanical vibrating compactors. The Contractor shall only use hand tamping in areas inaccessible to all other compaction equipment. On depressed areas, the Contractor may use a trench roller or cleated compression strips under a roller to transmit compression to the depressed area.

Any HMA that becomes unacceptable due to cooling, cracking, checking, segregation or deformation as a result of an interruption in mix delivery shall be removed and replaced with material that meets contract specifications at no cost to the Department.

For all items requiring pavement density testing, the Contractor shall cut 6-inch diameter cores at no additional cost to the Department by the end of the working day following paving. Cores shall be cut such that the nearest edge at least 9 inches from any joint. Pre-testing of the cores will not be allowed. If the Contractor and the Department mutually determine that a core is damaged, the Contractor shall cut new core(s) at the same offset and within 3 ft of the initial sample. The Contractor and the Department will mutually determine if underlying material is adhered to the core and if so will mark the core at the point where sawing is needed. The Department will place the cores in a secure container and the Contractor shall transport the cores to the designated MaineDOT lab. The cores will be saw cut by the Department to remove underlying layers. No recuts are allowed at a test location after the core has been tested.

On all sections of overlay with wearing courses designed to be 1 in or less in thickness, there shall be no pay adjustment for density otherwise noted in Section 403 - Hot Mix Asphalt Pavement. For overlays designed to be 1 in or less in thickness, density shall be obtained by the same rolling train and methods as used on mainline travelway surface courses with a pay adjustment for density, unless otherwise directed by the Department.

There shall be no pay adjustment for density on shoulders unless otherwise noted in Section 403 - Hot Mix Asphalt Pavement. Density for shoulders shall be obtained by the same rolling train and methods as used on mainline travelway, unless otherwise directed by the Department. Efforts to obtain optimum compaction will not be waived by the Department unless it is apparent during construction that local conditions make densification to this point detrimental to the finished pavement surface course.

401.16 Joints The Contractor shall construct wearing course transverse and longitudinal joints in such a manner that minimum tolerances shown in Section 401.11 - Surface Tolerances are met when measured with a straightedge. The paver screed shall maintain a uniform head of HMA during transverse and longitudinal joint construction. The HMA shall be free of segregation and meet temperature requirements outlined in Section 401.04. Transverse joints of the wearing course shall

be straight and neatly trimmed. The Contractor may form a vertical face exposing the full depth of the course by inserting a header, by breaking the bond with the underlying course, or by cutting back with hand tools. The Contractor shall apply a coating of emulsified asphalt immediately before paving all joints to the vertical face and 3 in of the adjacent portion of any pavement being overlaid except those formed by pavers operating in echelon. The Contractor shall use an approved spray apparatus designed for covering a narrow surface. The Department may approve application by a brush for small surfaces, or in the event of a malfunction of the spray apparatus, but for a period of not more than one working day.

Where pavement under this contract joins an existing pavement, or when the Department directs, the Contractor shall cut the existing pavement along a smooth line, producing a neat, even, vertical joint. The Department will not permit broken or raveled edges. The cost of all work necessary for the preparation of joints is incidental to related contract pay items. Longitudinal joints shall be generally straight to the line of travel and constructed in a manner that best ensure joint integrity. Methods or activities that prove detrimental to the construction of straight, sound longitudinal joints will be discontinued.

The Contractor may utilize an approved notched wedge joint device on all HMA layers 1 ½ inches in depth or greater. A notched wedge joint shall be constructed as shown in Figure 1 using a device that is attached to the paver screed and is capable of independently adjusting the top and bottom vertical notches.

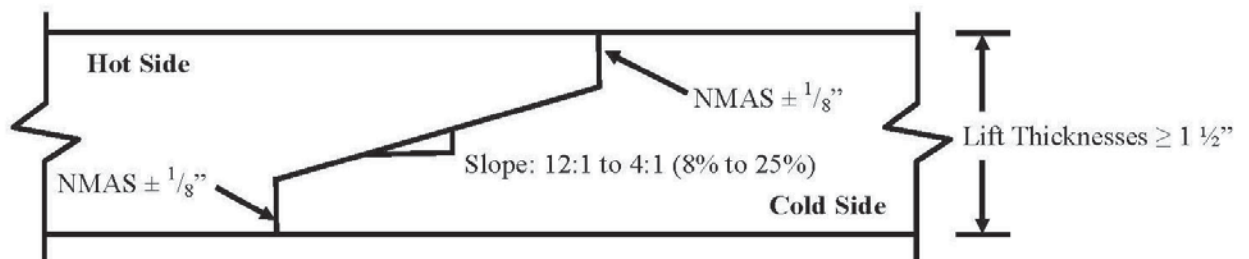

FIGURE 1: Notched Wedge Joint

Notes

1. An emulsified tack coat shall be applied to the vertical edges and the wedge surface so that the total rate is 0.05 G/SY plus the normal specified rate prior to placing the adjacent layer. The Contractor may elect to apply the emulsified tack coat in one or multiple passes.
2. Dimensions shown are compacted depths (after rolling is complete).

The Department reserves the right to have centerline cores cut by the Contractor's QC personnel for informational purposes to monitor the density along the joint. Informational cores at the centerline joint will be taken centered over the tapered part of the wedge joint.

Any notched wedge joint constructed areas that become cracked or broken shall be trimmed back to the limits affected prior to placing the adjoining lane. Any materials that become unbound or separated from the wedge or tapered joint section, or contaminated by materials determined by the Department as being detrimental to the construction of a sound construction joint, shall be removed by sweeping, compressed air and lance, or by hand tools as required. This work, if necessary, will not be paid for directly, but shall be considered incidental to the related contract items.

The Contractor shall apply a coating of emulsified asphalt on the vertical and tapered surface of the longitudinal centerline joint immediately before paving if the notched wedge joint device is used.

The total rate of application shall be 0.050 G/SY plus the normal specified tack coat rate. The Contractor shall use an approved spray apparatus designed for covering a narrow surface. The Department may approve application by a brush for small surfaces.

401.17 Hot Mix Asphalt Documentation The Contractor and the Department shall agree on the amount of Hot Mix Asphalt Pavement that has been placed each day. All delivery slips shall conform to the requirements of 401.078.

401.18 Prepave Meeting Prior to placing any mix, the Department and the Contractor shall hold a Pre-paving conference to discuss the paving schedule, source of mix, type and amount of equipment to be used, sequence of paving pattern, rate of mix supply, random sampling, project lots and sublots and traffic control. A copy of the density QC random numbers to be used on the project shall be provided to the Resident. The Departments' random numbers for Acceptance testing shall be generated and on file with the Resident and the Project Manager. All personnel of the Department and the Contractor who have significant information relevant to the paving items shall attend, including the responsible onsite paving supervisor for the Contractor. The Resident will prepare minutes of the conference and distribute them to all attendees. Any requests to revise the minutes must be made to the Resident within 7 Days of Receipt. These minutes will constitute the final record of the Pre-paving conference. On the first day of paving and whenever there is a change in the onsite paving foreman or paving inspector, the Department and the Contractor shall hold an informal onsite meeting to review the minutes of the Pre-paving conference, Project Specific QCP, Plans, Typical, Special Provisions and communication process. This meeting shall be held prior to placing any mix. The onsite paving supervisor, QCT, Superintendent, Resident and/or paving inspector shall attend.

401.19 Contractor Quality Control – Method A, B, C & D

The Contractor shall operate in accordance with the approved Quality Control Plan (QCP) to assure a product meeting the contract requirements. The Contractor shall not begin paving operations until the Department approves the QCP in writing.

401.191 Quality Control The QCP shall meet the requirements of Section 106.6 - Acceptance and this Section. The QCP shall address any items that affect the quality of the Hot Mix Asphalt Pavement, and shall include the following personnel meeting these minimum requirements:

- a. QCP Administrator - The QCP Administrator must be a full-time employee of or a consultant engaged by the Contractor or paving subcontractor. The QCP Administrator shall have full authority to institute any and all actions necessary for the successful operation of the QCP. The QCP Administrator (or their designee in the QCP Administrator's absence) shall be available to communicate with the Department at all times.
 - For items accepted under Methods A and B, the QCP Administrator shall be certified as a Quality Assurance Technologist (QAT) by NETTCP.
 - For items accepted under Methods C and D, the QCP Administrator shall be certified by NETTCP as a Quality Assurance Technologist (QAT), Plant Technician, or Paving Inspector.
- b. Process Control Technician(s) (PCT) shall utilize test results and other quality control practices to assure the quality of aggregates and other mix components and control proportioning to meet the JMF(s). The PCT shall inspect all equipment used in mixing to assure it is operating

properly and that mixing conforms to the mix design(s) and other Contract requirements, and that delivery slips and plant recordation accurately reflects the mix being produced with all the required information. The QCP shall detail how these duties and responsibilities are to be accomplished and documented, and whether more than one PCT is required. The Plan shall include the criteria to be utilized by the PCT to correct or reject unsatisfactory materials. The PCT shall be certified as a Plant Technician by the NETTCP.

c. Quality Control Technician(s) (QCT) shall perform and utilize quality control tests at the job site to assure that delivered materials meet the requirements of the JMF(s). The QCT shall inspect all equipment utilized in transporting, laydown, and compacting to assure it is operating properly and that all laydown and compaction conform to the Contract requirements. The QCP shall detail how these duties and responsibilities are to be accomplished and documented, and whether more than one QCT is required. The QCP shall include the criteria utilized by the QCT to correct or reject unsatisfactory materials. The QCT shall be certified as a Paving Inspector by the NETTCP.

The QCP shall detail the coordination of the activities of the Plan Administrator, the PCT and the QCT. The Project Superintendent shall be named in the QCP, and the responsibilities for successful implementation of the QCP shall be outlined.

The QCP shall address any items that affect the quality of the Hot Mix Asphalt Pavement including, but not limited to, the following:

a. General Requirements:

- Job Mix Formulas (JMFs)
- Name of QCP Administrator, and certification number
- Description of corrective action process
- Disposition of defective material
- A procedure to take immediate possession of acceptance samples once released by MaineDOT and deliver said samples to the designated acceptance laboratory.

b. Process Control Requirements: Each Hot Mix Asphalt plant shall have a Plant Specific Process Control Plan. At minimum the plan shall include:

- Name of Plant Specific Process Control Technician(s) and certification number(s)
- Hot mix asphalt plant details
- Stockpile Management
- Mixing & transportation
- Silo management and details
- A detailed description of RAP processing, stockpiling and introduction into the plant
- PG Binder management:
 - Tanks and storage (including polymer modified binders if applicable)
 - Binder temperature
 - Sample points
 - Method to ensure mixture contains the specified binder grade
 - Additive introduction details if introduced at the plant
- Testing and inspection plan for control of aggregates and RAP
- Mix Testing and inspection plan

c. Quality Control Requirements – Method A & B

- Name of Quality Control Technicians(s) and certification number(s)
- Laydown operations
- Longitudinal joint construction including the tacking of all joints.
- Procedures for avoiding paving in inclement weather
- Compaction of shoulders
- Methods to ensure that segregation is minimized
- Procedures to determine the maximum rolling and paving speeds based on best engineering practices and past experience in achieving acceptable pavement smoothness.
- Sequence for paving around drainage structures, under guard rail, around curb, at bridges, intersections, drives and minor approaches to ensure proper compaction, finish, and drainage.
- Type of release agent to be used on haul units, tools and rollers.

d. Quality Control Requirements – Method C and D

- Name of QCP Administrator and certification number(s) as specified in Section 401.19.
- Name of Process Control Technicians(s) and certification number(s).
- Name of Quality Control Technicians(s) and certification number(s).
- Anticipated Compaction Temperature Zones for each roller pass during placement.
- Mix TMD to be used for density gauge setting for method spec density work
- Procedures for avoiding paving in inclement weather.
- Type of release agent to be used on haul units, tools and rollers.
- A note stating that the use of petroleum-based fuel oils, such as diesel or kerosene, or asphalt stripping solvents will not be permitted.
-

The Contractor shall also supply a Laydown Operation Plan that addresses sequence of work, layout of work, longitudinal joint construction, compaction of shoulders, methods to minimize segregation, and procedures to achieve acceptable pavement smoothness.

For each production day, a summary of each day's results, including a daily paving report, summarizing the mixture type, mixture temperature, equipment used, environmental conditions, and the number of roller passes, shall be recorded and signed by the QCT and presented to the Department's representative by 1 PM the following working day.

Unless otherwise noted in Section 403 - Hot Mix Asphalt Pavement, the Contractor shall submit a modified QC Plan detailing, how the mix is to be placed, what equipment is to be used, and what HMA plant is to be used for Items covered under the Plan. All mix designs (JMF) shall be approved and verified by MaineDOT prior to use.

A QCP, certified QC personnel, and a Prepave Meeting shall not be required for Item 403.209 - Hot Mix Asphalt, 9.5 mm Nominal Maximum Size (sidewalks, drives, islands & incidentals) accepted under visual or Method D. An approved JMF shall be provided to the Resident prior to placement.

The Contractor shall certify the mix and the test results for each item by a Certificate of Compliance.

The Contractor shall have a testing lab at the plant site, equipped with all testing equipment necessary to complete the tests in Table 6. The Contractor shall generate QC sampling random numbers for each approved mix design. A copy of the random numbers shall be emailed to the QC.mainedot@maine.gov email address and remain on-file (in print) and be available for inspection at the QC laboratory. The Contractor shall sample, test, and evaluate Hot Mix Asphalt Pavement in accordance with the minimum frequencies per each approved mix design:

TABLE 6: MINIMUM QUALITY CONTROL FREQUENCIES

Test or Action	Frequency	Test Method
Temperature of mix	6 per day at street and plant	-
Temperature of mat	4 per day	-
%TMD (In-Place Density - Surface)	1 per 125 ton	AASHTO T 355 or AASHTO T 343
%TMD (In-Place Density - Base)	1 per 250 ton	AASHTO T 355 or AASHTO T 343
Fines / Effective Binder	1 per 500 ton	AASHTO T 312*
Gradation	1 per 500 ton	AASHTO T 30
PGAB Content	1 per 500 ton	AASHTO T 164 or AASHTO T 308
Voids at N_{design}	1 per 500 ton	AASHTO T 312*
VMA at N_{design}	1 per 500 ton	AASHTO T 312*
Rice Specific Gravity	1 per 500 ton	AASHTO T 209
Percent Fractured Particles	1 per 5,000 ton	AASHTO T 335
Flat and Elongated Particles	1 Per 5,000 ton	ASTM D4791
Fine Aggregate Angularity	1 Per 5,000 ton	AASHTO T 304

*Method A and B only

The Contractor shall monitor plant production on each approved mix design using running average of three control charts as specified in Section 106 - Quality. Control limits shall be as noted in Table 7 below. The UCL and LCL, shall not exceed the allowable gradation control points for the particular type of mixture as outlined in Table 1 of Section 703.09.

TABLE 7: CONTROL LIMITS

Property	UCL and LCL
Percent Passing 4.75 mm and larger sieves	Target +/- 4.0
Percent Passing 2.36 mm sieve	Target +/- 2.5
Percent Passing 0.075 mm sieve	Target +/- 1.0
PGAB Content	Target +/- 0.25
VMA at N_{design}	LCL = LSL + 0.2
Voids at N_{design}	JMF Target +/- 1.2
Theoretical Maximum Specific Gravity	JMF Target +/- 0.020

The Contractor shall submit all QC test and inspection reports and updated control charts to the Resident and QC.mainedot@maine.gov by email. The reports and updated control charts shall be signed by the appropriate technician and be submitted to the Department by 1:00 P.M. on the next working day, except when otherwise noted in the QCP and approved by the Department.

The Contractor shall also retain splits of the previous 5 QC tests, with QC results enclosed for random selection and testing by the Department. Test results of splits that do not meet the Dispute Resolution

Variance Limits in Table 18 shall trigger an investigation by the MaineDOT Independent Assurance Unit and may result in that lab losing NETTCP certification and the ability to request a dispute [Section 401.50 - Process for Dispute Resolution].

The Contractor shall make density test results, including randomly sampled densities, available to the Department onsite. Summaries of each day's results, including a daily paving report summarizing the mixture type, mixture temperature, equipment used, environmental conditions, and the number of roller passes, shall be recorded and signed by the QCT and provided to the QC.mainedot@maine.gov email address and Resident in writing by 1:00 p.m. the next working day. The Contractor shall fill all holes in the pavement resulting from cutting cores by the Contractor or the Department with a properly compacted, acceptable mixture no later than the following working day. Before filling, the Contractor shall carefully clean the holes and apply a coating of emulsified asphalt. The Contractor may only cut additional cores for verification of the densometer, at a rate not to exceed 3 per day or 2 per 1000 ton placed.

If the Contractor's control chart shows the process for a given mix design to be out of control (defined as a single point outside of the control limits on the running average of three chart) on any property listed in Table 7: Control Limits, the Contractor shall notify the Resident of all affected projects in writing of the corrective action by 1:00 PM the next working day. The written description shall detail what action is being taken by the Contractor to bring the property in question back within control limits. Subsequent quality control results are expected to demonstrate an improvement and regression towards the aim. The Department reserves the right to take action, to include cessation of production, in the case of repeated results outside the Table 7 control chart control limits.

On a daily basis, or whenever equipment type or sequence is modified, the Contractor shall perform density testing across the mat being placed, prior to being compacted by equipment at 12 in intervals. If the density values vary by more than 2.0% from the mean, the Contractor shall make adjustments to the screed until the inconsistencies are remedied. Failure to replace or repair defective placement equipment may result in a letter of suspension of work and notification of a quality control violation resulting in possible monetary penalties as governed by Section 106 – Quality.

The Contractor shall cease paving operations whenever one of the following occurs:

- a. The quality level for density using all quality control tests for the current Lot is less than 60 PWL.
- b. The Coarse Aggregate Angularity or Fine Aggregate Angularity value falls below the requirements of Section 703.07, Table 3: Aggregate Consensus Properties Criteria for the design traffic level.
- c. The Flat and Elongated Particles value exceeds 10% by ASTM D4791.
- d. There is any visible damage to the aggregate due to over-densification other than on variable depth shim courses.
- e. The Contractor fails to follow the approved QCP.

The Contractor shall notify the Resident in writing as to the reason for shutdown, as well as the corrective action, by the end of the workday. Failure to do so will be treated as a second incident under 106.4.6 QCP Non-compliance. The Department will only allow the continuation of paving operations when it is satisfied the corrective action will result in an improvement in results. The Department may require the submittal of a passing verification sample to allow further production. The Department

retains the exclusive right, with the exception of the first day’s production of a new JMF, to determine whether the resumption of production involves a significant change to the production process. If the Department so determines, then the current lot will be terminated, a pay factor established, and a new lot will begin.

The Contractor may utilize innovative equipment or techniques not addressed by the Contract documents to produce or monitor the production of the mix, subject to approval by the Department.

401.192 Quality Control for Method D, (sidewalks, drives, islands & incidentals) and visual acceptance items

A QCP, certified QC personnel, or Prepave Meeting shall not be required for Item 403.209 - Hot Mix Asphalt, 9.5 mm Nominal Maximum Size (sidewalks, drives, islands & incidentals) accepted under visual or Method D. An approved JMF shall be provided to the Resident prior to placement.

401.20 Acceptance Method A & C These methods utilize Quality Level Analysis and pay factor specifications. For Hot Mix Asphalt Pavement designated for acceptance under Quality Assurance provisions, the Department will sample once per subplot on a statistically random basis, test, and evaluate in accordance with the Acceptance Properties as outlined in Table 8:

TABLE 8: ACCEPTANCE PROPERTIES – METHOD A & C

Properties	Point of Sampling	Test Method
Gradation	Paver Hopper	AASHTO T 30
PGAB Content	Paver Hopper	AASHTO T 308
% TMD (In-Place Density)	Mat behind all Rollers	AASHTO T 269
Voids at N_{design}	Paver Hopper	AASHTO T 312
VMA at N_{design}	Paver Hopper	AASHTO T 312
Fines to Effective Binder	Paver Hopper	AASHTO T 312
VFB	Paver Hopper	AASHTO T 312

The Department will obtain samples of Hot Mix Asphalt Pavement in conformance with AASHTO R 97, Sampling Asphalt Mixtures, and the MaineDOT Policies and Procedures for HMA Sampling and Testing. The Contractor shall transport the samples in containers provided by the Department to the designated MaineDOT Laboratory within 48 hours except when otherwise noted in the project specific QCP or as directed by the Resident. Failure to deliver an acceptance sample to the designated acceptance laboratory will be considered the second incident under 106.4.6–QCP Non-Compliance.

Target values shall be as specified in the JMF. The Department will withhold reporting of the test results for the Acceptance sample until 7:00 AM, on the second working day of receipt of the sample, or after receipt of the Contractors results of the Acceptance sample split. Upon conclusion of each lot being evaluated under quality level analysis, where there is a minimum of four sublots, results shall be examined for statistical outliers, as stated in Section 106.7.2 - Statistical Outliers.

Lot sizes and subplot sizes shall be determined as outlined in Table 9.

TABLE 9: LOT AND SUBLOT SIZES – METHOD A & C

Lot Size*	Entire production per item per contract up to 6000 ton
Maximum Sublot Size – Mix	750 ton
Maximum Sublot Size – Density	Surface Layers – 250 ton Base / Intermediate Layers – 500 ton
Minimum Number of Samples – Mix	Four
Minimum Number of Samples – Density	Five

*Unless otherwise agreed upon at the Prepave Meeting

If there is less than one-half of a subplot remaining at the end, then it shall be combined with the previous subplot. If there is more than one-half subplot remaining at the end, then it shall constitute the last subplot

and shall be represented by test results. If it becomes apparent partway through a Lot that, due to an underrun, there will be insufficient mix quantity to obtain the minimum number of sublots needed, the Resident may adjust the size of the remaining sublots and select new sample locations based on the estimated quantity of material remaining in the Lot. Unanticipated over-runs of up to 1500 ton shall be rolled into the last lot. Cases where the lot is terminated prior to reaching completion shall be handled in accordance with Section 106.7.3 Early Termination of Lots. In cases where density incentive/disincentive provision apply, additional cores shall be taken to attain a minimum of three for the Lot.

Isolated Areas During the course of inspection, should it appear that there is an isolated area that is not representative of the lot based on a lack of observed compactive effort, excessive segregation, a change in process or any other questionable practice, that area may be isolated and tested separately. An area so isolated that has a calculated pay factor below 0.80 for Method A, based on three random tests shall be removed and replaced at the expense of the Contractor for the full lane width and a length not to be less than 150 ft.

TABLE 10: ACCEPTANCE LIMITS – METHOD A & C

Property	USL and LSL	
	Method A	Method C
Percent Passing 4.75 mm and larger sieves	Target +/- 7%	Target +/- 7%
Percent Passing 2.36 mm to 1.18 mm sieves	Target +/- 4%	Target +/- 5%
Percent Passing 0.60 mm sieve	Target +/- 3%	Target +/- 4%
Percent Passing 0.30 mm to 0.075 mm sieve	Target +/- 2%	Target +/- 2%
PGAB Content	Target +/- 0.4%	Target +/- 0.4%
Voids at N_{design}	4.0% +/- 1.5%	N/A
Fines to Effective Binder	0.9 +/- 0.3	N/A
VMA at N_{design}	LSL from Table 1	N/A
VFB	Table 1 plus a 4% production tolerance for USL	N/A
% TMD (In-place Density)	94.5% +/- 2.5%	94.5% +/- 2.5%

Cease Production The Contractor shall cease paving operations whenever one of the following occurs on a lot in progress:

TABLE 11: CEASE PRODUCTION – METHOD A & C

Property	Percent Within Limits (PWL)	
	Method A	Method C
Percent Passing NMAS sieve*	<60 PWL	<60 PWL
Percent Passing 2.36 mm sieve*		
Percent Passing 0.30 mm sieve*		
Percent Passing 0.075 mm sieve*		
PGAB Content		N/A
Voids at N _{design}		
Fines to Effective Binder*		
VMA at N _{design}		
VFB		
% TMD (In-place Density)		

*Paving operations shall not be required to cease if the mean test value is equal to the LSL or USL and $s = 0$.

In cases where the Contractor is to cease paving operations based upon an Acceptance result or payfactor, the Contractor will submit a corrective action plan to the Department. The Department will only allow the continuation of paving operations when it is satisfied the corrective action will result in an improvement in results. The Department may require the submittal of a passing verification sample to allow further production.

401.201 Pay Adjustment - Method A & C The Department will use the following criteria for pay adjustment at the completion of the Lot using the pay adjustment factors under Section 106.7 - Quality Level Analysis:

Density Upon conclusion of each lot, density results shall be examined for statistical outliers as stated in Section 106.7.2. If the pay factor for Density falls below 0.80, all of the cores will be randomly re-cut by Sublot. A new pay factor will be calculated that combines all initial and retest results. If the resulting pay factor is below 0.80, the entire Lot shall be removed and replaced with material meeting the specifications at no additional cost to the Department, except that the Department may, when it appears that there is a distinct pattern of defective material, isolate any defective material by investigating each mix sample sublot and require removal of defective mix sample sublots only, leaving any acceptable material in place if it is found to be free of defective material. Pay factors equal to or greater than the reject level will be paid accordingly.

Mix Properties The Department will determine a pay factor (PF) using the applicable Acceptance Limits. If all three pay factors for PGAB Content, VMA at N_{design}, and Voids at N_{design} fall below 0.80 for Method A, then the composite pay factor for PGAB Content, VMA at N_{design}, and Voids at N_{design} shall be 0.50.

The following variables will be used for pay adjustment:

- PA = Pay Adjustment
- Q = Quantity represented by PF in ton
- P = Contract price per ton
- PF = Pay Factor

The Department will determine a pay adjustment using Table 12: Pay Adjustment Calculations as follows:

TABLE 12: PAY ADJUSTMENT CALCULATIONS – METHOD A & C

Acceptance Method	Mix Properties / Gradation	Density
Method A	$PA = (\text{Voids @ } N_d \text{ PF} - 1.0)(Q)(P) \times 0.20 + (\text{VMA @ } N_d - 1.0)(Q)(P) \times 0.20 + (\text{PGAB Content PF} - 1.0)(Q)(P) \times 0.10$	$PA = (\text{density PF} - 1.0)(Q)(P) \times 0.50$
Method C	$PA = (\% \text{ Passing Nom. Max PF} - 1.0)(Q)(P) \times 0.05 + (\% \text{ passing } 2.36 \text{ mm PF} - 1.0)(Q)(P) \times 0.05 + (\% \text{ passing } 0.30 \text{ mm PF} - 1.0)(Q)(P) \times 0.05 + (\% \text{ passing } 0.075 \text{ mm PF} - 1.0)(Q)(P) \times 0.10 + (\text{PGAB Content PF} - 1.0)(Q)(P) \times 0.25$	$PA = (\text{density PF} - 1.0)(Q)(P) \times 0.50$

In addition, for 9.5 mm NMA mixtures the following pay adjustment shall also apply:

The average percent passing for the 0.075 mm sieve shall be evaluated for each Lot. If the average is greater than 6.5%, a pay adjustment according to Table 13 below shall apply in addition to the other pay adjustments for the given method of testing.

TABLE 13: 0.075 MM SIEVE PAY ADJUSTMENT

Average Percent Passing 0.075 mm Sieve	Pay Adjustment
6.6% - 7.0%	-5%
> 7.0%	-10%

The Department shall notify the Contractor whenever the average of at least three samples in a given Lot is greater than 6.5%.

401.21 Acceptance Method B & D Unless otherwise stated in the 403 special provision, the Lot shall be the entire mix quantity per item per contract. The Department will sample once per subplot per pay item on a statistically random basis, test, and evaluate in accordance with the Acceptance Properties in Table 14. The Department will obtain samples of Hot Mix Asphalt Pavement in conformance with AASHTO R 97, Sampling Asphalt Mixtures, and the MaineDOT Policies and Procedures for HMA Sampling and Testing. The Contractor shall transport the samples in containers provided by the Department to the designated MaineDOT Laboratory within 48 hours except when otherwise noted in the project specific QCP or as directed by the Resident. Failure to deliver an acceptance sample to the designated acceptance laboratory will be considered the second incident under 106.4.6–QCP Non-Compliance. Target values shall be as specified in the JMF. The Department will withhold reporting of the test results for the Acceptance sample until 7:00 AM, on the second working day of receipt of the sample, or after receipt of the Contractors results of the Acceptance sample split.

TABLE 14: ACCEPTANCE PROPERTIES – METHOD B & D

Properties	Point of Sampling		Test Method
	Method B	Method D	
Gradation	Paver Hopper	Paver Hopper or Truck	AASHTO T 30
PGAB Content	Paver Hopper	Paver Hopper or Truck	AASHTO T 308
% TMD (In-Place Density)	Mat behind all Rollers	Mat behind all Rollers	AASHTO T 269
Voids at N_{design}	Paver Hopper	N/A	AASHTO T 312
VMA at N_{design}	Paver Hopper	N/A	AASHTO T 312
Fines to Effective Binder	Paver Hopper	N/A	AASHTO T 312
VFB	Paver Hopper	N/A	AASHTO T 312

TABLE 15: LOT AND SUBLOT SIZES – METHOD B & D

Lot Size*	Entire mix quantity per item per contract	
Maximum Sublot Size – Mix	(Lot size \leq 1000 tons)	(Lot size $>$ 1000 tons)
	250 ton	750 ton
Sublot Size – Density	125 ton (Max 5 Sublots)	250 ton

*General – Lot and Sublot size may be adjusted to accommodate the work scope and schedule, or as otherwise agreed upon at the Prepave Meeting

TABLE 16: ACCEPTANCE LIMITS – METHOD B & D

Property	USL and LSL	
	Method B	Method D
Percent Passing 4.75 mm and larger	Target +/- 7%	Target +/- 7%
Percent Passing 2.36 mm sieve	Target +/- 5%	Target +/- 7%
Percent Passing 1.18 mm sieve	Target +/- 5%	Target +/- 5%
Percent Passing 0.60 mm sieve	Target +/- 4%	Target +/- 4%
Percent Passing 0.30 mm sieve	Target +/- 3%	Target +/- 3%
Percent Passing 0.075 mm sieve	Target +/- 3%	Target +/- 3%
PGAB Content	Target +/- 0.5%	Target +/- 0.5%
Voids at N_{design}	4.0% +/- 2.0%	N/A
Fines to Effective Binder	0.9 +/- 0.3	N/A
VMA at N_{design}	LSL from Table 1	N/A
VFB	Table 1 plus a 4% production tolerance for USL	N/A
% TMD (In-place Density)	94.5% +/- 2.5%	LSL of 92.0%

The Contractor shall cease paving operations whenever two consecutive Method B or D tests fall outside specification limits on the same property. The Contractor will submit a corrective action plan to the Department. The Department will only allow the continuation of paving operations when it is satisfied the corrective action will result in an improvement in results. The Department may require the submittal of a passing verification sample to allow further production.

401.211 Pay Adjustment - Method B & D For items accepted under Method B or D, if the mix is within the tolerances listed in Table 16, the Department will pay the contract unit price, otherwise pay adjustments as shown in Table 17 shall be applied to the quantity of mix represented by the test. The Contractor shall cut one 6 in core per subplot unless otherwise noted in Section 403 - Hot Mix Asphalt Pavement. If the density result is not within the specified limits the disincentive shall apply. If the subplot density is less than 88.5 percent or greater than 99.0 percent of the subplot TMD, two additional cores shall be cut at random locations determined by the Department. If either of the additional cores has a density less than 88.5 percent or greater than 99.0 percent of the subplot TMD, the subplot shall be removed and replaced at no cost to the Department; otherwise, the average of the three cores will be used to determine the subplot pay adjustment.

TABLE 17: PAY ADJUSTMENTS – METHOD B & D

Property	Method B		Method D	
Percent Passing 2.36 mm sieve	N/A		-2.0%	
Percent Passing 0.30 mm sieve	N/A		-1.0%	
Percent Passing 0.075 mm sieve	-2.0%		-2.0%	
PGAB Content	-5.0%		-5.0%	
Voids at N _{design}	-3.0%		N/A	
% TMD (In-place Density)	91.5% - 91.9% or 97.1% - 97.5%	-5.0%	91.5% - 91.9%	-5.0%
	90.5% - 91.4% or 97.6% - 98.5%	-10.0%	90.5% - 91.4%	-10.0%
	89.5% - 90.4% or 98.6% - 99.0%	-20.0%	89.5% - 90.4%	-20.0%
	88.5% - 89.4%	-30.0%	88.5% - 89.4%	-30.0%
	<88.5% or >99.0%	Reject	<88.5% or >99.0%	Reject

401.30 Method of Measurement The Department will measure Hot Mix Asphalt Pavement by the ton in accordance with Section 108.1 - Measurement of Quantities for Payment.

401.40 Basis of Payment The Department will pay for the work, in place and accepted, in accordance with the applicable sections of this Section, for each type of HMA specified.

The Department will pay for the work specified in Section 401.12, for the HMA used, except that cleaning objectionable material from the pavement and furnishing and applying bituminous material to joints and contact surfaces is incidental.-Payment for this work under the appropriate pay items shall be full compensation for all labor, equipment, materials, and incidentals necessary to meet all related contract requirements, including design of the JMF, implementation of the QCP, obtaining core samples, transporting cores and samples, filling core holes, applying emulsified asphalt to joints, and providing testing facilities and equipment. The Department will make a pay adjustment for quality as specified in Section 401.20 Acceptance Method A & B or 401.21 Acceptance Method C & D.

401.50 Process for Dispute Resolution At the time of Hot-Mix Asphalt sampling, the Department will obtain a split sample of each Acceptance test random sample for possible dispute resolution testing. The Contractor shall also obtain a split sample of the HMA at this same time. If the

Contractor wishes to retain the option of requesting dispute testing of the initial Acceptance sample, the Contractor will test their split of the Acceptance sample in accordance with applicable AASHTO procedure and accepted supplemental practice as described in the Department's HMA Sampling and Testing Policies and Procedures manual. The Contractor shall report their results to the Resident, with a copy to Contractor.mainedot@maine.gov by 7:00 AM, on the second working day from time of QA sampling, otherwise dispute resolution will not be initiated. The Department's dispute resolution split sample will be properly labeled and stored for a period of at least two weeks after it has been reported, or until the sample is tested. The properties eligible for dispute and the respective variances are shown in Table 18.

The Contractor may dispute the Department's Acceptance results and request that the dispute resolution split sample be tested by notifying the Department's Resident and QA Engineer in writing within two working days after the results of the Acceptance test are reported. The following shall be provided in the request:

- Acceptance sample reference number
- The specific test result(s) or property(ies) being disputed, and
- The complete, signed report of the Contractor's testing (In a lab certified by the NETTCP and MaineDOT) of their split of the Acceptance sample indicating that the variances in Table 18 for the specific test result(s) or property(ies) were exceeded.

TABLE 18: DISPUTE RESOLUTION VARIANCE LIMITS

Property	Method A & B	Method C & D*	Variance Limits
PGAB Content	Yes	Yes	+/- 0.4%
G_{mb}	Yes	No	+/- 0.030
G_{mm}	Yes	No	+/- 0.020
Voids at N_{design}	Only if G_{mb} or G_{mm} is not disputable	No	+/- 0.8%
VMA at N_{design}	Only if G_{mb} or G_{mm} is not disputable	No	+/- 0.8%
Percent Passing 4.75 mm and larger sieves	No	Yes	+/- 4.0%
Percent Passing 2.36 mm to 0.60 mm sieves	No	Yes	+/- 3.0%
Percent Passing 0.30 mm to 0.15 mm sieves	No	Yes	+/- 2.0 %
0.075 mm sieve	Only for 9.5 mm NMA mixes	Yes	+/- 0.8%

*Disputes will not be allowed on Item 403.209

The value of any disputed result or property reported for the initial Acceptance sample shall stand if the value reported for the dispute resolution sample is not closer to the value the Contractor reported for their split sample than to the value reported for the initial Acceptance sample. If the value reported for the dispute resolution falls precisely half-way between the other two values the value reported for the dispute resolution will replace the original acceptance value. Otherwise, the value reported for the dispute resolution sample will replace the value reported for the initial Acceptance sample and will be used to re-calculate any other affected results or properties.

SECTION 402 - PAVEMENT SMOOTHNESS

402.00 Smoothness Projects Projects to have their pavement smoothness analyzed in accordance with this Specification will be so noted in Special Provision 403 - Hot Mix Asphalt Pavement.

402.01 Pavement Smoothness The final pavement surface shall be evaluated for smoothness using a Class I or Class II profiler as defined by ASTM E950 (94). Smoothness measurements will be expressed in terms of the International Roughness Index (IRI) as defined by the World Bank, in units of inches/mile.

402.02 Lot Size Lot size for smoothness will be 3000 lane-feet. A subplot will consist of 50 lane-feet. Partial lots will be included in the previous lot if less than one-half the size of a normal lot. If equal to or greater than one-half the normal lot size, it will be tested as a separate lot.

402.03 Acceptance Testing The Department will conduct Acceptance testing following completion of the surface course. Sections to be excluded from testing include the following:

- Bridge decks and joints (no smoothness measurements will be taken within 100 ft of bridge joints)
- Acceleration and deceleration lanes
- Shoulders and ramps
- Side streets and roads
- Within 100 ft of transverse joints at the beginning and end of the project
- Within 100 ft of railroad crossings
- Urban areas with speed limits of 30 mph or lower

Each lot shall have 2 measurements made in each wheel path. The average of the 4 measurements will determine the smoothness for that lot. The smoothness measurements will be statistically evaluated for pay factors as described in Subsection 106.7 - Quality Level Analysis, using the specification limits shown below.

TABLE 1: ACCEPTANCE LIMITS

Level	USL
I	55 in/mile
II	65 in/mile
III	75 in/mile

Computation of Smoothness Pay Adjustment:

$$PA = (PF-1.0)(Q)(P)$$

where:

Q = Quantity of surface course in the Lot (excluding shoulders, side streets, bridge decks, ramps, acceleration and deceleration lanes)

PF = smoothness pay factor for the Lot

P = Contract unit price for surface pavement

PA = pay adjustment

402.04 Unacceptable Work In the event that any Lot is found to have a pay factor less than 0.80, the Contractor shall take whatever remedial action is required to correct the pavement surface in that Lot at no additional expense to the Department. Such remedial action may include but is not limited to removal and replacement of the unacceptable pavement. In the event remedial action is necessary, the Contractor shall submit a written plan to the Resident outlining the scope of the remedial work. The Resident must approve this plan before the remedial work can begin. Following remedial work, the Lot shall be retested, and will be subject to the specification limits listed above. The resulting pay factor, if within the acceptable range, will be used in the final pay adjustment. The Contractor shall pay the cost of retesting the pavement following corrective action.

Localized surface tolerance defects will be subject to the provisions outlined in Section 401.11 Surface Tolerances.

Payment will be made under:

<u>Pay Item</u>	<u>Pay Unit</u>
402.10 Incentive/Disincentive - Pavement Smoothness	Lump Sum

SECTION 403 - HOT MIX ASPHALT PAVEMENT

403.01 Description This work shall consist of constructing one or more courses of Hot Mix Asphalt pavement on an approved base in accordance with these specifications, and in reasonably close conformity with the lines, grades, thickness and typical cross sections shown on the plans or established. The HMA pavement shall be composed of a mixture of aggregate, filler if required, and asphalt material.

403.02 General The materials and their use shall conform to the requirements of Section 401 - Hot Mix Asphalt Pavement.

403.03 Construction The construction requirements shall be as specified in Section 401 - Hot Mix Asphalt Pavement.

403.04 Method of Measurement Hot mix asphalt pavement will be measured as specified in Section 401.21- Method of Measurement.

403.05 Basis of Payment The accepted quantities of hot mix asphalt pavement will be paid for at the contract unit price per ton for the mixtures, including hot mix asphalt material complete in place. Method A, Method B, Method C and Method D shall be used for acceptance as specified in Section 401 - Hot Mix Asphalt Pavements. (See Complementary Notes, Section 403 - Hot Mix Asphalt Pavement, for Method location).

Payment will be made under:

<u>Pay Item</u>	<u>Pay Unit</u>
403.102 Hot Mix Asphalt Pavement for Special Areas	Ton
403.206 Hot Mix Asphalt, 25 mm Nominal Maximum Size	Ton
403.207 Hot Mix Asphalt, 19.0 mm Nominal Maximum Size	Ton
403.2071 Hot Mix Asphalt, 19.0 mm Nominal Maximum Size (Polymer Modified)	Ton
403.2072 Asphalt Rich Hot Mix Asphalt, 19.0 mm Nominal Maximum Size (Asphalt Rich Base and Intermediate course)	Ton
403.208 Hot Mix Asphalt, 12.5 mm Nominal Maximum Size	Ton
403.2081 Hot Mix Asphalt - 12.5 mm Nominal Maximum Size (Polymer Modified)	Ton
403.209 Hot Mix Asphalt, 9.5 mm Nominal Maximum Size (Sidewalks, Drives, Islands & Incidentals)	Ton
403.210 Hot Mix Asphalt, 9.5 mm Nominal Maximum Size	Ton
403.2101 Hot Mix Asphalt, 9.5 mm Nominal Maximum Size (Polymer Modified)	Ton
403.2104 Hot Mix Asphalt, 9.5 mm Nominal Maximum Size (Thin Lift Surface Treatment)	Ton
403.211 Hot Mix Asphalt, 9.5 mm Nominal Maximum Size (Shimming)	Ton
403.2111 Hot Mix Asphalt, 9.5 mm Nominal Maximum Size (Shimming, Polymer Modified))	Ton
403.212 Hot Mix Asphalt, 4.75 mm Nominal Maximum Size	Ton
403.213 Hot Mix Asphalt, 12.5 mm Nominal Maximum Size (Base and Intermediate Base course)	Ton
403.2131 Hot Mix Asphalt, 12.5 mm Nominal Maximum Size (Base and Intermediate Base course, Polymer Modified)	Ton
403.2132 Asphalt Rich Hot Mix Asphalt, 12.5 mm Nominal Maximum Size (Base and Intermediate Base course)	Ton
403.214 Hot Mix Asphalt, 4.75 Nominal Maximum Size (5/8" Surface Treatment)	Ton

SPECIAL PROVISION
SECTION 401 - HOT MIX ASPHALT PAVEMENT
(HMA with Fine Micro-Deval Requirement)

The following subsections of the most current version of Specification 401 – Hot Mix Asphalt Pavements have been revised and amended by the following:

401.01 Description The Contractor shall compose Hot Mix Asphalt (HMA) Pavement with aggregate, Performance Graded Asphalt Binder (PGAB), and mineral filler if required. If denoted in Special Provision 403 - Hot Mix Asphalt Pavement, the mixtures shall meet the additional aggregate requirements of this special provision.

401.02 Materials Materials shall meet the requirements specified in Section 700 – Materials, unless otherwise revised in this special provision:

Aggregates for HMA Pavement	703.07
HMA Mixture Composition	703.09

The HMA blend, minus any RAP used, shall have a Fine Micro-Deval value of 15.0 or less as determined by weighted average of individual fine aggregate source values determined through ASTM D7428.

SPECIAL PROVISION
SECTION 403
HOT MIX ASPHALT

Desc. Of Course	Grad Design.	Item Number	Total Thick	No. Of Layers	Comp. Notes
<u>¾" Mill & UTBWC Overlay</u>					
<u>Travelway, Truck Lanes (As Indicated)</u>					
Wearing	Type C	462.301	¾"	1	2,9,24,27
<u>Spot Shims (As Indicated or As Directed)</u>					
Shim	9.5 mm	403.211	Variable	1/more	3,8,20,30

COMPLEMENTARY NOTES

2. The required PGAB shall be a storage-stable, homogeneous, polymer modified asphalt binder that meets **PG 64E-28** grading requirements in AASHTO M 332. All polymer modified asphalt grades utilized on the Project shall be treated with an approved liquid anti-strip. PG binders shall be treated either at the asphalt source terminal with the required dose rate on the delivery documentation, or at the hot mix asphalt plant utilizing a system integrated with the plants controls that will introduce a minimum 0.50 percent anti-strip by weight of asphalt binder used unless a rate is otherwise recommended by the anti-strip manufacturer. The PGAB and anti-strip blend shall meet the **PG 64E-28** requirements. The Contractor shall provide supporting test data showing the PGAB and anti-strip blend meet the required criteria.
3. The design traffic level for mix placed shall be <3 million ESALS. The design, verification, Quality Control, and Acceptance tests for this mix will be performed at **65 gyrations**.
9. Material will be tested in accordance with Special Provision 462 - Gap-Graded HMA - Ultra-Thin Bonded Wearing Course.
8. Section 106.6 Acceptance, (2) **Method B** as specified Section 401.21 - Quality Assurance Methods B and D.
20. The combined aggregate gradation required for this item shall be classified as a 9.5mm Thin Lift Mixture (TLM) mixture, using the Aggregate Gradation Control Points as defined in 703.09.
24. See Special Provision 462 – Ultra Thin Bonded Wearing Course for project specifics.
27. See Special Provision 401 - HMA with Fine Micro-Deval Requirement for project specifics.
30. The incentive/disincentive provisions for density shall not apply. Rollers shall meet the requirements of this special provision. The use of an oscillating steel roller shall be required to compact all mixtures pavements placed on bridge decks.

Tack Coat

A tack coat of emulsified asphalt, RS-1, RS-1h, CRS-1 or CRS-1h, Item 409.15 shall be applied to any existing pavement at a rate of approximately 0.030 gal/yd², and on milled pavement approximately 0.05 gal/yd² prior to placing a new course. A fog coat of emulsified asphalt shall be applied between shim /base courses and surface course as well as to any bridge membrane prior to the placement of HMA layers at a rate not to exceed 0.030 gal/yd². Tack used will be **paid for at the contract unit price** for Item 409.15 Bituminous Tack Coat.

SPECIAL PROVISION
SECTION 400
Pavements

(Emulsified Asphalt Seal Coat with Cover Coat Material)

Description This work consists of furnishing and applying one or more applications of emulsified asphalt sealcoat material with cover coat material on an approved surface in accordance with these specifications, and in reasonably close conformity with the lines shown on the plans or established.

Materials The bituminous material shall meet the applicable requirements of Section 702 – Bituminous Materials. Liquid asphalt grades for the fog coat treatment shall meet the requirements for CSS-1, CSS-1h, CRS-2h, or CRS-2P. The emulsion type selected shall be used for the entire fog seal application areas unless otherwise approved by the Department.

The emulsified asphalt shall be produced with an approved, certified emulsion product, diluted, and thoroughly mixed into a homogenous liquid at the emulsion manufacturing facility. Each load shall be accompanied by a loading invoice listing the material supplier, emulsion type, dilution rate, total quantity loaded, and copy of the undiluted emulsified asphalt product certification. The diluted emulsion shall meet the requirements listed in Table 1 of this specification.

Table 1 – Diluted Asphalt Emulsion for Seal Coat

<u>Test requirements for diluted material</u>	<u>Range</u>
Sieve test %	0 – 0.10
Residue by distillation, %	28 - 40
Penetration	40 - 90
Application Temperature	100 - 180°F

The cover coat material shall be black or dark brown in color. Cover coat material shall be dried and free from moisture, and be of similar type and size as aluminum oxide or silicon carbide abrasive sandblasting grit meeting the “fine” or “extra fine” gradation requirements (ref: Black Beauty abrasive or similar product).

The Contractor may propose an alternative material for the aggregate cover, but will be required to demonstrate the materials compatibility with the emulsion fog seal prior to use on the project.

Equipment Emulsified asphalt sealcoat material application equipment shall meet the requirements specified in Section 409 – Bituminous Tack Coat, subsection 409.05 – Equipment with the addition of the following:

The asphalt distributor shall contain suitable mechanical circulating and heating mechanisms to provide a uniform approved temperature of the entire mass of material. The distributor shall be equipped with a radar type sensor used to measure ground speed, and feed a Digital Volumetric Accumulator capable of measuring gallons applied and distance traveled.

It shall be capable of applying asphalt material in accurately measured quantities at any rate between 0.01 to 2.0 gallons per square yard, of roadway surface, at any length of spray bar up to 16 feet. The distributor shall be capable of maintaining a uniform rate of distribution of asphalt material regardless of change in grade, width or direction of the road. It shall be equipped with an electronic control for setting asphalt pump discharge rate and on/off switching of spray for nozzles in one (1) foot, increments which shall be located in the truck cab. The spray nozzles and pressure system shall provide a sufficient and uniform fan-shaped spray of asphalt material throughout the entire length of the spray bar at all times while operating. The spray shall completely cover the roadway surface receiving the treatment.

The aggregate spreader shall be mounted on the asphalt distributor. It shall have a minimum capacity of 2000 lbs. The hopper shall have vibratory agitation to facilitate material flow. The cover aggregate spinners shall be variable speed, capable of distributing cover aggregate consistently over variable roadway widths in a single pass. All controls shall be cab-mounted and capable of being operated during the application of the asphalt emulsion by the distributor operator.

CONSTRUCTION PROCEDURES

Weather Limitations Emulsified asphalt sealcoat material shall not to be applied when the atmospheric temperature is below 50°F, or pavement surface temperature below 50°F.

Emulsified asphalt sealcoat shall not be applied in wet conditions, or when wet weather conditions are forecasted within a 6 hour period after application.

Preparation of Surface Before application of the emulsion seal coat material the surface shall be thoroughly cleaned of all loose and objectionable material. Preparation of the surface shall be considered incidental to the contract. The Contractor shall be responsible for covering all utility irons just prior to application of emulsion and uncovering utilities after application.

Immediately before applying an emulsified asphalt seal coat, the pavement surface must be cleaned with a road sweeper, power broom to remove dust, dirt, and debris. The pavement surface must be clean and dry before applying the emulsified asphalt sealcoat.

Application Emulsified asphalt seal coat materials shall be applied by a pressure distributor in a uniform, continuous spread over the area to be treated. The target application rate shall be 0.12 gallons per square yard. Emulsion application rates may be adjusted within the range of 0.10 to 0.14 gallons per square yard, as determined by the test section and as directed by the Department. No additional payment consideration or adjustment shall be made unless the required application rate varies from the rate as specified above.

The cover aggregate shall be applied immediately after the emulsion, prior to the emulsion break or cure, and simultaneously with the pressure distributors pass.

Equipment or traffic will not be allowed on the emulsion treated surface until the emulsion has fully cured. Emulsion materials will be applied within the temperature range specified in Section 702.05 – Application Temperatures, or as otherwise listed in this specification. No moisture shall be present on the roadway surface.

The Contractor shall provide dry cover material meeting the requirements of this specification and at a spread rate of 0.35 to 0.75 lbs./ s.y. as determined by the control section. The Contractor shall be required to apply additional cover material above the prescribed rate in the event that excessive emulsion materials are applied. Use of cover material shall be paid for by the pound, by means of verified bagged quantity, or by scaled weight of actual materials applied.

A test section shall be established to verify emulsion and cover coat material target application rates. The section shall be of sufficient length to verify the approximate emulsion use at the prescribed rate. Generally, the length of test section shall be approximately 200-500 linear feet. During emulsion seal material application, adequate provisions shall be made to prevent marring and discoloration of adjacent pavements, structures, vehicles, foliage or personal property. The use of skirting or end panels may be required to control application widths, and limit overspray.

Areas found to lack the proper emulsified asphalt seal coat application rate will require a re-application of emulsion material to meet the required rate. Areas requiring re-application will not be paid for directly but shall be considered incidental to the emulsified asphalt seal coat pay item,

In the event that excessive emulsion materials are applied, the use of cover coat material shall be used to reduce the risk of bleeding and tracking by traffic. Additional aggregate cover material, if required, will be considered incidental to the emulsified asphalt seal coat pay item.

Traffic Control The Contractor may be allowed a limited lane closure lengths if outlined in the contract. If allowed in the contract, traffic volumes shall be monitored to determine peak traffic levels, and lane closures shall be allowed outside peak traffic level times. The Traffic Control Plan will be amended to address traffic control at intersections, businesses, or other high traffic areas. Additional signage shall be used to at .5 mile intervals to warn motorists to stay out of the closed lane and off the sealant. When mainline travelway sealing work is required, adequate quantity and properly spaced cones for travelway delineation along with cones or barricades shall be required. Whether treating travelway, or shoulders, cones or barricades shall be placed across the treated area every 500 ft, immediately after the emulsion and aggregate application, to prevent vehicles from traveling through the sealant during the cure period.

All traffic shall be kept off the emulsified asphalt seal coat areas for a minimum of 4 hours or until curing is complete. The emulsified asphalt seal coat surface will be considered cured when the emulsion and cover coat material does not track off the treated surface and there are no visible uncured emulsion on the surface. The Contractor may elect to use a polymer modified emulsion to further reduce cure time. No additional payment will be made should a polymer modified emulsion be used.

METHOD OF MEASUREMENT AND BASIS OF PAYMENT

Method of Measurement The Department will measure the emulsified asphalt seal coat by the square meter (square yard). Payment will be for the actual number of square yards applied in accordance with the typical, Standard Specifications, and Section 109 - Measurement and Payment. Payment for the cover coat material will be paid for by the pound, verified by independent scale checks for bagged or bulk products. Payment shall be full compensation for all labor, materials and equipment required to complete the work in accordance with these specifications.

Basis of Payment The Department will pay for the Work, in place and accepted, in accordance with the applicable sections of the Special Provisions at the contract unit price per square yard applied, and by the pound applied.

Payment will be made under:

<u>Pay Item</u>	<u>Pay Unit</u>
410.151 Emulsified Asphalt Seal Coat, Applied	Square Yard
410.161 Cover Coat Material, Sand	Pound

SPECIAL PROVISION
SECTION 424
ASPHALT RUBBER CRACK SEALER – Type 2

Description This work shall consist of furnishing all labor, equipment and materials necessary to clean, fill and seal longitudinal and transverse cracks in bituminous concrete pavement courses. Materials are to be thoroughly applied to seal the cracks. This work shall consist of the furnishing and placement of crack sealing material in the cracks of existing bituminous concrete pavement in accordance with these Special Provisions. This work shall consist of crack cleaning and drying, material supply and heating, preparation and application material, material finishing or shaping, and providing and installing barrier material or curing materials as required.

Materials Asphalt Rubber Crack Sealer shall be an asphalt and rubber compound designed for a temperature range of 64-28 °C, and which improves the strength and performance of the base asphalt cement. Hot pour rubber crack sealant material shall conform to ASTM D-6690, Type 2.

Cone Penetration	90 max
Flow @ 60°C [140°F]	< 1/4 inch
Bond, non-immersed	Three ½ inch specimens pass 3 cycles @ 50% extension @ -20
Resilience, %	N/A
Asphalt Compatibility, ASTM D5329	pass*

* There shall be no failure in adhesion, formation of any oily exudate at the interface between the sealant and asphaltic concrete or other deleterious effects on the asphaltic concrete or sealant when tested at 140°F.

The contractor shall provide the Resident or authorized representative with a copy of the material manufacturer's recommendations pertaining to heating, application, and reheating prior to the beginning of operations or the changing of materials.

CONSTRUCTION REQUIREMENTS

Weather Asphalt Rubber Crack Sealer shall not be applied on a wet surface, or when the atmospheric temperature is below 50°F in a shaded area at the job site, or when weather conditions are otherwise unfavorable to proper construction procedures.

Equipment Equipment used in the performance of the work shall be subject to the Resident's or authorized representative's approval and shall be maintained in a satisfactory working condition at all times. As a minimum, the equipment required will consist of the following:

(1) Air Compressor and air wand: A portable air compressor shall be supplied to clean the cracks to be sealed prior to using a hot air lance. The air compressor shall be coupled with hose and air wand and be capable of furnishing not less than 150 CFM of air at not less than 100 psi pressure through a 5/8"- inch diameter nozzle. A 1/2 -inch or 3/4-inch nozzle may be used with approval of the Inspector as long as the pressure requirements are being met. The compressor shall be equipped with traps that will maintain the compressed air free of oil and water.

(2) Sweeper: Manually operated, gas powered air-broom or self-propelled sweeper designed especially for use in cleaning pavements shall be used to remove debris, dirt, and dust from the cracks.

(3) Hot Air Lance: The hot air lance shall be independent of the air wand unit. The hot air lance shall be operated with propane and compressed air in combination and provide 1000 ft/sec of heated air at 2000°F - 3000°F. The lance should draw propane from no smaller than a 100 lb tank using separate hoses for propane and air draw. The hoses shall be wrapped together with reflectorized wrap to keep them together and to protect workers in low light situations.

(4) Hand Tools: Shall consist of V-shaped squeegee, brooms, shovels, metal bars with chisel shaped ends, and any other tools which may be satisfactorily used to accomplish this work.

(5) Melting Kettle: The unit used to melt the joint sealing compound shall be a double boiler, indirect fired type. The space between inner and outer shells shall be filled with a suitable heat transfer oil or substitute having a flash point of not less than 608°F. The kettle shall be equipped with a satisfactory means of agitating and mixing the joint sealer at all times. This may be accomplished by continuous stirring with mechanically operated paddles and/or a continuous circulating gear pump attached to the heating unit. The kettle must be equipped with thermostatic control calibrated between 200°F and 550°F. The Contractor shall either provide a jacketed thermometer that accurately displays the sealant temperature within the kettle, or provide the Resident or authorized representative with a suitable device for verifying the sealant temperature in the kettle. Temperatures must be able to be checked at any time during the heating of material, application of material, or at the end of the application operation.

Preparations of Cracks All cracks shall be blown free of loose material, dirt, vegetation, and other debris by high pressure air prior to the used of the hot air lance. Material removed from the crack shall be removed from the pavement surface by means of compressed air, power sweeper or appropriate hand tools as required. Cracks showing evidence of vegetation after being blown out shall be additionally cleaned by appropriate hand tools and additionally blown out. All cracks must be blown and heated via the hot air lance no more than 5 minutes prior to the crack

being sealed. Distance between the hot air lance and the crack sealing unit should be no more than 50 ft to eliminate reinvasion of water, debris, and other incompressible materials. All debris, vegetation, and water shall be removed to enhance adhesion of the crack sealing material. THIS WORK SHALL NOT BE DONE IN INCLEMENT WEATHER.

Preparation and Placement of Sealer The rubber crack sealer material shall be heated and applied at the temperature specified by the manufacturer and approved by the Resident or authorized representative. Any material that has been heated above the manufacturer's specification shall not be used. Material that is reheated or held at temperature for an extended period of time may be used as allowed by the manufacturer's specification and approval of the Resident or authorized representative. A copy of the manufacturer's specification shall be provided to the Project when requested.

The Contractor shall provide the Resident or authorized representative with a suitable device for verifying the sealant temperature in the kettle and at the application site.

Any loose material on the surface or in the crack, which may contaminate the crack sealer or impede bonding of the sealant to the pavement, is to be removed by hand tools prior to crack filling. No crack filling material shall be applied in a crack that is wet or where frost, snow, or ice is present. The ambient air temperature must be 50 or higher.

Any over application or spills are to be removed to the satisfaction of the Resident or authorized representative. Any sealed areas with damaged or contaminated sealer or visible voids are to be removed, prepared and resealed. Defective or leaking valves and wands will be repaired or replaced before work continues. If repairs or replacement of defective equipment cannot be accomplished immediately then the Department may permit work to continue but deduct any excess quantities placed as it determines.

Sealer shall be delivered to the crack while the cracks are still hot from the hot air lance preparation through a pressure hose line and applicator nozzle or shoe.

If the work scope requires a flush fill with minimal overbanding then a nozzle sized to fill the cracks shall be used.

If the work scope required crack filling and sealing with overband, then a shoe sized to meet the overband width shall be used. Generally, the shoe width and the sealer overbanding area shall range from 1 inch – 1.5 inch. Overbanding width may vary from the range specified depending on the width and severity of the cracks.

The applicator shall be followed by a V-shaped squeegee to minimize the thickness of the overband. The sealer shall be applied at a rate that produces a coating thickness of 1/8 - inch, typical.

If the sealed area is to be opened to traffic immediately, a barrier material (de-tackifier) such as Glenzoil or an equivalent product approved by the Resident shall be provided by the Contractor and shall be applied to the crack sealer to prevent pickup as directed by the Resident or authorized representative.

If the sealed areas are to be paved over with a hot mix treatment then a 48 hour minimum cure time and use of barrier material (de-tackifier) will be required. Cure times may be extended if excessive pick-up of the crack sealants occurs.

Quality of Work Any excess of sealer, spilled or overapplied, shall be removed from the pavement by approved methods and discarded. Any quality of work determined to be below normal acceptable standards will not be accepted, and will be corrected and/or replaced as directed by the Resident or authorized representative.

Method of Measurement Asphalt Rubber Crack Sealer will be measured by the pound of sealant used. The manufacturer's weights of the sealant for each block (pill) will be accepted as a basis for measurement.

Should tank checks be required to verify material usage, or calculate initial or final gallons remaining in the kettle, a calibrated tank gauge or tank stick shall be used to measure the tank gallons, and a volume correction shall be calculated using Table:1 to correct the gallons to 60 ° F. The corrected gallons shall then be multiplied by the pounds per gallon at 60 ° F listed in the product data sheet provided for the crack seal product being used. The corrected volume and resultant pounds shall be made part of the method of measurement, with consideration given to blocks (pills) added during the day and applied in an acceptable manner.

Basis of Payment The accepted quantity of Asphalt Rubber Crack Sealer will be paid for at the contract unit price per pound complete in place. This price shall be full compensation for furnishing and placing crack sealer, including cleaning cracks and furnishing and placing barrier materials if necessary.

Payment will be made under:

<u>Pay Item</u>	<u>Pay Unit</u>
424.22 Asphalt Rubber Crack Sealer Type 2, Applied	Pound

Conversion Table:1

t	M	t	M	t	M	t	M	t	M	t	M
100	0.9861	135	0.9740	170	0.9621	205	0.9503	240	0.9385	275	0.9269
101	0.9857	136	0.9737	171	0.9618	206	0.9499	241	0.9382	276	0.9266
102	0.9854	137	0.9734	172	0.9614	207	0.9496	242	0.9379	277	0.9263
103	0.9851	138	0.9730	173	0.9611	208	0.9493	243	0.9375	278	0.9259
104	0.9847	139	0.9727	174	0.9607	209	0.9489	244	0.9372	279	0.9256
105	0.9844	140	0.9723	175	0.9604	210	0.9486	245	0.9369	280	0.9253
106	0.9840	141	0.9720	176	0.9601	211	0.9483	246	0.9365	281	0.9250
107	0.9837	142	0.9716	177	0.9597	212	0.9479	247	0.9362	282	0.9246
108	0.9833	143	0.9713	178	0.9594	213	0.9476	248	0.9359	283	0.9243
109	0.9830	144	0.9710	179	0.9590	214	0.9472	249	0.9356	284	0.9240
110	0.9826	145	0.9706	180	0.9587	215	0.9469	250	0.9352	285	0.9236
111	0.9823	146	0.9703	181	0.9584	216	0.9466	251	0.9349	286	0.9233
112	0.9819	147	0.9699	182	0.9580	217	0.9462	252	0.9346	287	0.9230
113	0.9816	148	0.9696	183	0.9577	218	0.9459	253	0.9342	288	0.9227
114	0.9813	149	0.9693	184	0.9574	219	0.9456	254	0.9339	289	0.9223
115	0.9809	150	0.9689	185	0.9570	220	0.9452	255	0.9336	290	0.9220
116	0.9806	151	0.9686	186	0.9567	221	0.9449	256	0.9332	291	0.9217
117	0.9802	152	0.9682	187	0.9563	222	0.9446	257	0.9329	292	0.9213
118	0.9799	153	0.9679	188	0.9560	223	0.9442	258	0.9326	293	0.9210
119	0.9795	154	0.9675	189	0.9557	224	0.9439	259	0.9322	294	0.9207
120	0.9792	155	0.9672	190	0.9553	225	0.9436	260	0.9319	295	0.9204
121	0.9788	156	0.9669	191	0.9550	226	0.9432	261	0.9316	296	0.9200
122	0.9785	157	0.9665	192	0.9547	227	0.9429	262	0.9312	297	0.9197
123	0.9782	158	0.9662	193	0.9543	228	0.9426	263	0.9309	298	0.9194
124	0.9778	159	0.9658	194	0.9540	229	0.9422	264	0.9306	299	0.9190
125	0.9775	160	0.9655	195	0.9536	230	0.9419	265	0.9302	300	0.9187
126	0.9771	161	0.9652	196	0.9533	231	0.9416	266	0.9299	301	0.9184
127	0.9768	162	0.9648	197	0.9530	232	0.9412	267	0.9296	302	0.9181
128	0.9764	163	0.9645	198	0.9526	233	0.9409	268	0.9293	303	0.9177
129	0.9761	164	0.9641	199	0.9523	234	0.9405	269	0.9289	304	0.9174
130	0.9758	165	0.9638	200	0.9520	235	0.9402	270	0.9286	305	0.9171
131	0.9754	166	0.9635	201	0.9516	236	0.9399	271	0.9283	306	0.9167
132	0.9751	167	0.9631	202	0.9513	237	0.9395	272	0.9279	307	0.9164
133	0.9747	168	0.9628	203	0.9509	238	0.9392	273	0.9276	308	0.9161
134	0.9744	169	0.9624	204	0.9505	239	0.9389	274	0.9273	309	0.9158

Legend: t = observed temperature in degrees Fahrenheit.
M = multiplier for reducing volumes to the basis of 60° F.

Conversion Table:1

t	M	t	M	t	M	t	M	t	M
310	0.9154	350	0.9024	390	0.8896	430	0.8768	470	0.8643
311	0.9151	351	0.9021	391	0.8892	431	0.8765	471	0.8640
312	0.9148	352	0.9018	392	0.8889	432	0.8762	472	0.8636
313	0.9145	353	0.9015	393	0.8886	433	0.8759	473	0.8633
314	0.9141	354	0.9011	394	0.8883	434	0.8756	474	0.8630
315	0.9138	355	0.9008	395	0.8880	435	0.8753	475	0.8627
316	0.9135	356	0.9005	396	0.8876	436	0.8749	476	0.8624
317	0.9132	357	0.9002	397	0.8873	437	0.8746	477	0.8621
318	0.9128	358	0.8998	398	0.8870	438	0.8743	478	0.8618
319	0.9125	359	0.8995	399	0.8867	439	0.8740	479	0.8615
320	0.9122	360	0.8992	400	0.8864	440	0.8737	480	0.8611
321	0.9118	361	0.8989	401	0.8861	441	0.8734	481	0.8608
322	0.9115	362	0.8986	402	0.8857	442	0.8731	482	0.8605
323	0.9112	363	0.8982	403	0.8854	443	0.8727	483	0.8602
324	0.9109	364	0.8979	404	0.8851	444	0.8724	484	0.8599
325	0.9105	365	0.8976	405	0.8848	445	0.8721	485	0.8596
326	0.9102	366	0.8973	406	0.8845	446	0.8718	486	0.8593
327	0.9099	367	0.8969	407	0.8841	447	0.8715	487	0.8590
328	0.9096	368	0.8966	408	0.8838	448	0.8712	488	0.8587
329	0.9092	369	0.8963	409	0.8835	449	0.8709	489	0.8583
330	0.9089	370	0.8960	410	0.8832	450	0.8705	490	0.8580
331	0.9086	371	0.8957	411	0.8829	451	0.8702	491	0.8577
332	0.9083	372	0.8953	412	0.8826	452	0.8699	492	0.8574
333	0.9079	373	0.8950	413	0.8822	453	0.8696	493	0.8571
334	0.9076	374	0.8947	414	0.8819	454	0.8693	494	0.8568
335	0.9073	375	0.8944	415	0.8816	455	0.8690	495	0.8565
336	0.9070	376	0.8941	416	0.8813	456	0.8687	496	0.8562
337	0.9066	377	0.8937	417	0.8810	457	0.8683	497	0.8559
338	0.9063	378	0.8934	418	0.8806	458	0.8680	498	0.8556
339	0.9060	379	0.8931	419	0.8803	459	0.8677	499	0.8552
340	0.9057	380	0.8928	420	0.8800	460	0.8674		
341	0.9053	381	0.8924	421	0.8797	461	0.8671		
342	0.9050	382	0.8921	422	0.8794	462	0.8668		
343	0.9047	383	0.8918	423	0.8791	463	0.8665		
344	0.9044	384	0.8915	424	0.8989	464	0.8661		
345	0.9040	385	0.8912	425	0.8984	465	0.8658		
346	0.9037	386	0.8908	426	0.8781	466	0.8655		
347	0.9034	387	0.8905	427	0.8778	467	0.8652		
348	0.9031	388	0.8902	428	0.8775	468	0.8649		
349	0.9028	389	0.8899	429	0.8772	469	0.8646		

Legend: t = observed temperature in degrees Fahrenheit.
M = multiplier for reducing volumes to the basis of 60° F.

SPECIAL PROVISION
SECTION 462
GAP-GRADED HMA
(Ultra-Thin Bonded Wearing Course)

The following subsections of the most current version of Specification 401 – Hot Mix Asphalt Pavements have been revised and modified by the following:

Description This work shall be constructed in accordance with the applicable referenced sections of Division 400 – Pavements; Section 401 – Hot Mix Asphalt Pavement, and the requirements of Section 106 – Quality. All sections not revised by this Special Provision shall be as outlined in the Special Provision 400 Pavements, Section 401 – Hot Mix Asphalt Pavement. References to Standard Specifications, Special Provisions, or other documents, shall be determined as the most current version available at the time of bid, or as amended. The Ultra-Thin Bonded Wearing Course consists of a warm polymer modified asphalt emulsion tack coat followed immediately with an Ultra-Thin hot mix asphalt wearing course. The tack coat is spray applied immediately prior to the application of the wearing course to produce a durable wearing surface that can be opened to traffic. The finished surface treatment has a nominal thickness of ½”, for Type A, 5/8” for Type B, and ¾” for Type C.

MATERIALS

The Contractor shall formulate and submit to the Department, a job mix formula (JMF) that satisfies the design general limits listed in Table 1 – Mixture requirements. The JMF aims shall not fall outside the general design limits.

TABLE 1: COMPOSITE GRADATION

AASHTO Standard Sieve Size	Total % Passing by Weight		
	Type A - ¼”	Type B - ⅜”	Type C - ½”
19 mm (¾”)	-	-	100
12.5 mm (½”)	-	100	85-100
9.5 mm (⅜”)	97-100	85-100	45-85
4.75 mm (#4)	40-60	24-41	24-41
2.36 mm (#8)	21-33	21-33	21-33
1.18 mm (#16)	15-26	15-26	15-26
0.60 mm (#30)	11-20	11-20	11-20
0.30 mm (#50)	8-16	8-16	7-16
0.15 mm (#100)	5-10	5-10	5-10
0.075 mm (#200)	4.0-7.0	4.0-7.0	4.0-7.0
Minimum % PGAB	5.1	5.0	5.0

*All aggregate percentages are based on the total weight of the aggregate. The composite gradation for each individual type of mixture shall meet the gradation requirements of Table 1.

The estimated PG binder film thickness shall be calculated for the submitted mix design. Designs with estimated film thickness less than 10 microns may be approved pending successful placement in the field. The estimated film thickness of asphalt shall be calculated using the effective asphalt content in conjunction with the surface area for the aggregates in the JMF according to the following formula and the factors in Table 2:

$$FT = \frac{AC \cdot 1000}{SA \cdot SG}$$

where: *FT* = film thickness (microns)
AC = asphalt content of mix design (%)
SA = total surface area of aggregate (SM/Kg)*
SG = specific gravity of asphalt

* Surface area is calculated by multiplying the percent passing for the design by the factors in the table below for each sieve size and summing the resultant values.

TABLE 2: SURFACE AREA FACTORS

AASHTO Standard Sieve Size	Surface Area Factors (SM/Kg)		
	Type A - 1/4"	Type B - 3/8"	Type C - 1/2"
19 mm (3/4")	-	-	0.41
12.5 mm (1/2")	-	0.41	0
9.5 mm (3/8")	0.41	0	0
4.75 mm (#4)	0.41	0.41	0.41
2.36 mm (#8)	0.82	0.82	0.82
1.18 mm (#16)	1.64	1.64	1.64
0.60 mm (#30)	2.87	2.87	2.87
0.30 mm (#50)	6.14	6.14	6.14
0.15 mm (#100)	12.29	12.29	12.29
0.075 mm (#200)	32.77	32.77	32.77

Aggregates used shall be from an approved source and shall meet the requirements of section 703.07 for 3.0 to < 10 million ESALs, and as modified by items 1 through 7 listed below.

1. Individual coarse aggregates sources shall meet a Micro-Deval (AASHTO T 327) value of 18 or less.
2. Individual coarse aggregates sources shall have a maximum LA Abrasion (AASHTO T96) of 30.
3. Absorption by AASHTO T 84 shall be less than 2.0% for fine aggregate blends.
4. Absorption by AASHTO T 85 shall be less than 2.0% for coarse aggregate blends.
5. Aggregates shall have a minimum sand equivalent of 45, (AASHTO T 176), and the fine aggregate shall be 100% crushed.
6. 95 % of the aggregate shall have at least a single face crushed and 85% shall have 2 or more crushed.
7. Percent by weight of Flat and Elongated particles shall be (5:1 ratio) with 10% maximum.
8. Coarse aggregates, when measured in any dimension, shall not contain particles larger than the lift being placed or 3/4 inch, whichever is less.

The Contractor shall test all materials and provide copies of all test results to the Department for materials utilized in the completion of the work. The Contractors’ test results shall be submitted to the Department along with the mix design submittal in accordance with the MaineDOT HMA Policy and Procedures Manual.

Performance Graded Asphalt Binder Unless otherwise shown in the contract bid items or noted in Special Provision 403 - Hot Bituminous Pavement, all asphalt binders shall meet a 64-28 PGAB grade. The Contractor may use an approved chemical or wax based warm mix additive when producing UTBWC mixtures using modified PGAB such as 64E-28.

Emulsified Tack Coat Tack Coat shall be modified with latex, natural or synthetic, and shall be certified as meeting the requirements of ASTM D2397 except as modified in Table 3 – Tack Coat Material Properties. It is required that the latex be co-milled at the bulk emulsion facility, to ensure complete and balanced blending. CRS-1P asphalt grade emulsions shall have a minimum asphalt content ratio of 63%.

TABLE 3: TACK COAT MATERIAL PROPERTIES

Property	Method	Minimum	Maximum
Latex Content, % Mass of Total Residue		3.0	
Viscosity at 25°C, (Sec.)	ASTM D244	20	100
Setting Time, Minutes	Observation	3	7
Demulsibility, % by wt. Residue	ASTM D244	40	
Penetration, 25°C (77°F)	T 49	60	150

Deliveries of the emulsified tack coat shall be accompanied by a loading invoice, delivery ticket, or slip, as required under Section 108.1.3 f in addition to the Certificate of Analysis. The emulsified tack coat loading invoice/delivery ticket and Certificate of Analysis shall be provided to the Resident. In the event an intermediate hauler of the asphalt material is involved, a copy of their own delivery slip shall be furnished, as well as a copy of the supplier's loading invoice. The hauler's delivery slip and the supplier's loading invoice shall be cross-referenced by use of their respective serial numbers.

EQUIPMENT

Spray Pavers The spray paver shall be configured to spray tack at the specified rate, and apply hot mix asphalt seconds later. The spray bar shall be located just ahead of the paver’s auger, and distribute the liquid through computer-controlled, self-cleaning valves. An onboard microprocessor shall be capable of precisely controlling the rate of flow interlocked to the paver speed. Spray valves shall also be controlled manually if needed. The paver shall have a receiving hopper with sufficient capacity for a uniform spreading operation and a mixture distribution system to place the mixture uniformly, without segregation. The screed assembly shall produce a finished surface of the uniform texture without tearing, shoving, or gouging the mixture.

The self-priming spray paver must be capable of spraying the tack coat, applying the hot asphalt overlay and smoothing the surface of the mat being paved in one pass, at the rate of 33-98 feet per minute. The self-priming spray paver must incorporate a receiving hopper, feed conveyor, heated or insulated storage tank for emulsion, metered tack coat spray bar and a variable width, heated, ironing type screed. The self-priming spray paver shall be a track or rubber tire mounted highway class paver with a minimum combined tractor and screed weight of 44,000 pounds, and a minimum main screed

width of 8 feet. All paver screeds shall be outfitted with auger and tunnel extensions as required to distribute the mix within two feet of the end gate. All pavers shall have power extendible, activated, and heated screed extensions designed by the manufacturer for highway paving. Screeds shall be configured to place mixtures to the required width, crown, and breakpoints as directed by the Department. The paver must have a material receiving hopper size capable of accepting haul trucks, and be of sufficient size and weight to maintain the required rate of placement, line of travel, depth, and cross section while engaged with a loaded tri-axle or trailer haul unit. The screed must be sized to place the mixture over the entire lane width being paved in one pass. It shall also have the ability to be positively crowned at the center of lane and have adjustable extensions to accommodate the desired pavement width and cross sectional profile. The Contractor shall operate the paver in such a manner as to produce a visually uniform surface texture. Any UTBWC that becomes visually unacceptable due to mixture cooling, checking, segregation or deformation as a result of an interruption in mix delivery, or excessive delays in re-charging the emulsion tanks shall be removed and replaced with material that meets contract specifications at no cost to the Department.

Rollers The Contractor shall use 7 foot wide double drum steel wheeled rollers weighing at least 8 to 10 ton, that are equipped with functioning water systems and scrapers to prevent the fresh mix from adhering to the roller drums. If the rollers narrower than 7 foot are to be used, the Contractor will be required to use additional rollers or slow placement speed of the paver to ensure full mat coverage is made immediately behind the spray paver.

CONSTRUCTION DETAILS

Weather and Seasonal Limitations All work shall be in accordance with Section 401 – Hot Mix Asphalt Pavement , subsection 401.06 - Weather and Seasonal Limitations.

Surface Preparation The Contractor shall remove painted striping, mill the existing pavement surface as described in the contract documents, crack seal as required by the contract documents, and sweep the roadway as needed prior to the surface treatment. Stripe removal, milling and crack seal will be paid for under the appropriate contract items.

Crack sealing, if required in the contract, will be paid under the appropriate crack seal item. The Contractor shall crack seal transverse and longitudinal cracks as considered appropriate. Unless otherwise directed cracks shall be flush filled with minimal over-banding, and the material type and shall conform to ASTM D-6690, Type II or AASHTO M 324, and paid under the appropriate Type II crack seal item.

Spot shims or leveling course, if required by the Department, shall be paid for under the appropriate 403.211 - 9.5mm shim unit price included in the contract. Sweeping will not be paid for directly, but shall be included in the 462.30 or 462.301 - Ultra-Thin Bonded Wearing Course contract price.

Application The screed on the paver shall be heated to a temperature between 275°F-335°F before placing Ultra-Thin Bonded Wearing Course on the roadway. Apply the tack coat meeting the requirements of Table 3 at a temperature of 120° - 180° F. The application of tack coat shall be uniform across the entire width to be overlaid, at a rate of 0.22 - 0.25 gallons per square yard, depending upon the existing surface texture. Field adjustments to the target application rate of tack coat shall be determined based upon the existing surface condition of the pavement. The tack coat application rate may be adjusted to 0.17-0.22 gallons per square yard if used over newly placed HMA

levelling course. Adjustments to the tack coat target application rate shall be approved by the Department. All changes to the emulsified tack coat application shall be located with station references, recorded, and included in the daily QC report.

The Contractor shall make all efforts to minimize walking on the unrolled mat. Displacement, marring, or depressions that result from walking on or across the mat will require immediate repair before rolling. Repeated incidences of irreparable surface defects may result in work stoppage until the issue is resolved.

A tack coat of CRS-1P shall be applied to the vertical transverse joint surface and the underlying roadway at each transverse joint takeoff. Should the spray paver be unable to apply tack coat to the vertical transverse joint when paving a tack coat of CRS-1P or RS-1 shall be applied to the vertical joint and adjacent surfaces for at least the first 10 feet. The application rate shall be a minimum of 0.05 gal/s.y. for the tack application at transverse joints. The Contractor shall continuously monitor the rate of spray. No equipment shall come in contact with the tack coat before the hot mix asphalt wearing course is applied. Immediately after applying the tack coat, the contractor shall apply the hot mix asphalt overlay across the full width of the tack coat at a temperature of 290° - 335° F.

Compaction The Contractor shall begin compaction immediately behind the spray paver after the application of wearing course. The roller(s) shall make a minimum of two passes. The roller(s) will not be allowed to stop on the freshly placed wearing course. The Contractor shall use an adequate number of rollers to complete compaction and aggregate seating before the pavement surface temperature falls below 185° F for 64-28 PGABs, or below 210° F for PG 64E-28. The Contractor shall provide an additional roller if the Contractor elects to pave travelway and adjacent shoulder concurrently and the adjacent shoulder exceeds four feet in width. The Contractor shall protect the wearing course from traffic until the rolling operation is complete and the material has cooled sufficiently to resist damage.

UTBWC Documentation The Contractor and the Department shall agree on the amount of UTBWC, measured in square yards, that has been placed each day. The Contractor and the Department shall agree on the amount of emulsified tack coat (in gallons) and HMA (in tons) that have been placed each day. All delivery slips shall conform to the requirements of 401.073.

Quality Control All work shall be in accordance with Division 400 – Pavements; Section 401 – Hot Mix Asphalt Pavement , subsection 401.19- Quality Control Method A, B & C, with the exception of the following revisions;

The Contractor shall sample, test, and evaluate Hot Mix Asphalt Pavement in accordance with the following minimum frequencies per each approved mix design:

TABLE 4: MINIMUM QUALITY CONTROL FREQUENCIES

Test or Action	Frequency	Test Method
Temperature of mix	6 per day at street and plant	-
Temperature of mat	4 per day	-
Emulsified tack coat application rate & yield*	1 per 10,000 SY (minimum of 2 per day)	-
Gradation	1 per 500 ton	AASHTO T 30
PGAB content	1 per 500 ton	AASHTO T 164 or T 308
Rice Specific Gravity	1 per 500 ton	AASHTO T 209
Coarse Aggregate Angularity	1 per 5000 ton	ASTM D5821
Flat and Elongated Particles	1 Per 5000 ton	ASTM D4791
Fine Aggregate Angularity	1 Per 5000 ton	AASHTO T 304

* Emulsified tack coat application rate and yield shall be verified independent of the rate displayed on the paver

The Contractor shall monitor plant production on each approved mix design using running average of three control charts as specified in Section 106 - Quality. Control limits shall be as noted in Table 5 below.

TABLE 5: CONTROL LIMITS

Property	UCL and LCL
Passing NMAS sieve	Target +/-4.0 [∨]
Passing 4.75 mm and larger sieves	Target +/-4.0
Passing 2.36 mm sieve	Target +/-2.5
Passing 0.075 mm sieve	Target +/-1.0 [^]
PGAB Content*	Target +/-0.25
Theoretical Maximum Specific Gravity	JMF Target +/-0.020

[∨] The mixture shall be produced to comply with the control points outlined in Table 1.

* Based on AASHTO T 308

[^] The minimum LCL shall be 3.0% and the maximum UCL shall be 7.0%.

Acceptance Acceptance shall be in accordance with this Special Provision. The Lot size will be the entire production per JMF for the project, or if so agreed at the Pre-paving Conference, equal lots of up to 4,500 tons (120,000 square yards). Remaining tonnage (square yards) may be rolled into the last lot allowed up to a maximum size of 6,000 tons (160,000 square yards). Sublot sizes shall be 750 tons (20,000 square yards) for mixture properties, with unanticipated over-runs of up to one-half of the sublot rolled into the last sublot. The minimum number of sublots per Lot for mixture properties shall be five.

TABLE 6: UTBWC ACCEPTANCE CRITERIA

Property	Point of Sampling	Test Method
Gradation	Paver Hopper	AASHTO T 30
PGAB Content	Paver Hopper	AASHTO T 308

TABLE 7: UTBWC ACCEPTANCE LIMITS

Property	USL and LSL
Passing NMAS sieve	Target +/-5%*
Passing 4.75 mm and larger sieves	Target +/-5%
Passing 2.36 mm to 1.18 mm sieves	Target +/-3%
Passing 0.60 mm	Target +/-3%
Passing 0.30 mm to 0.15 mm sieve	Target +/-2%
Passing 0.075 mm sieve	Target +/-2%^
PGAB Content	LSL = Target - 0.3% USL = Target + 0.4%

* The mixture shall be produced to comply with the control points outlined in Table 1.

^ The minimum LSL shall be 3.0% and the maximum USL shall be 7.0%.

Pay Adjustment The Department will sample, test, and evaluate Hot Mix Asphalt Pavement in accordance with Section 106 – Quality, and Section 401.20 – Acceptance Method A & C of Division 400 – Pavements, and this Special Provision.

The Department will use Performance Graded Asphalt Binder content, and the screen sieve sizes listed in this specification for the type of mixture represented in the JMF. If the pay factor for any single property falls below 0.85, the Contractor shall cease production and submit a corrective action plan to the Department at the HMA plant. If any the pay factor for any single property falls below 0.80, the Contractor shall also provide a passing verification sample to the Department before production can resume. Production may resume when the Department is satisfied the corrective action proposed will provide an improvement in results.

PGAB Content and Gradation The Department will determine a pay factor for each square yard using Table 7: Acceptance Limits. The Department will calculate the price adjustment for Mixture Properties as follows:

$$PA = 0.70[(\% \text{ Passing Nom. Max PF}-1.0)(Q)(P)X0.05+(\% \text{ passing 2.36 mm PF}-1.0)(Q)(P)X0.05+(\% \text{ passing 0.30 mm PF}-1.0)(Q)(P)X0.05+(\% \text{ passing 0.075 mm PF}-1.0)(Q)(P)X0.10+(\text{PGAB PF}-1.0)(Q)(P)X0.25]$$

Dispute Resolution All work shall be in accordance with Division 400 – Pavements; Section 401 – Hot Mix Asphalt Pavement , subsection 401.50 - Process for Dispute Resolution.

Method of Measurement Ultra-Thin Bonded Wearing Course shall be measured by the square yard.

Basis of Payment The accepted quantity of Ultra-Thin Bonded Wearing Course will be paid for at the contract unit price per square yard, complete in-place which price will be full compensation for furnishing all equipment, material, labor, and all incidentals necessary to complete the work. Pay adjustments may be made as outlined in this specification.

Payments will be made under:

<u>Pay Item</u>		<u>Pay Unit</u>
462.30	Ultra-Thin Bonded Wearing Course	Square Yard
462.301	Polymer-Modified Ultra-Thin Bonded Wearing Course	Square Yard

SPECIAL PROVISION
SECTION 652
MAINTENANCE OF TRAFFIC

Approaches. Approach signing shall include the following signs at a minimum. Field conditions may warrant the use of additional signs as determined by the Resident..

Road Work Next X* Miles
Road Work 500 Feet (Ahead)
End Road Work

Work Areas. At each work site, signs and channelizing devices shall be used as directed by the Resident.

Signs include:

Road Work xxxx¹.
One Lane Road Ahead
Flagger Sign

Other typical signs include:

Be Prepared to Stop
Low Shoulder
Bump
Pavement Ends

The above lists of Approach signs and Work Area signs are representative of the contract requirements. Other sign legends may be required.

The Contractor shall conduct their operations in such a manner that the roadway will not be restricted to one lane for more than 2,500 feet at each work area. To encourage quality paving in warm-weather conditions, the length can be extended to 4,000 feet depending on the traffic impacts. Where more than one work area restricts traffic to one lane operation, these work areas shall be separated by at least 1 mile of two way operation.

Temporary Centerline A temporary centerline shall be placed each day on all new pavement to be used by traffic. The temporary centerline, when specified of reflectorized traffic paint, shall conform to the standard marking patterns used for permanent markings. Failure to apply a temporary centerline daily will result in a Traffic Control Violation and suspension of paving operations until temporary markers are applied to all previously placed pavement.

¹ “Road Work Ahead” to be used in short duration operations and “Road Work xx feet” to be used in stationary operations as directed by the Resident.

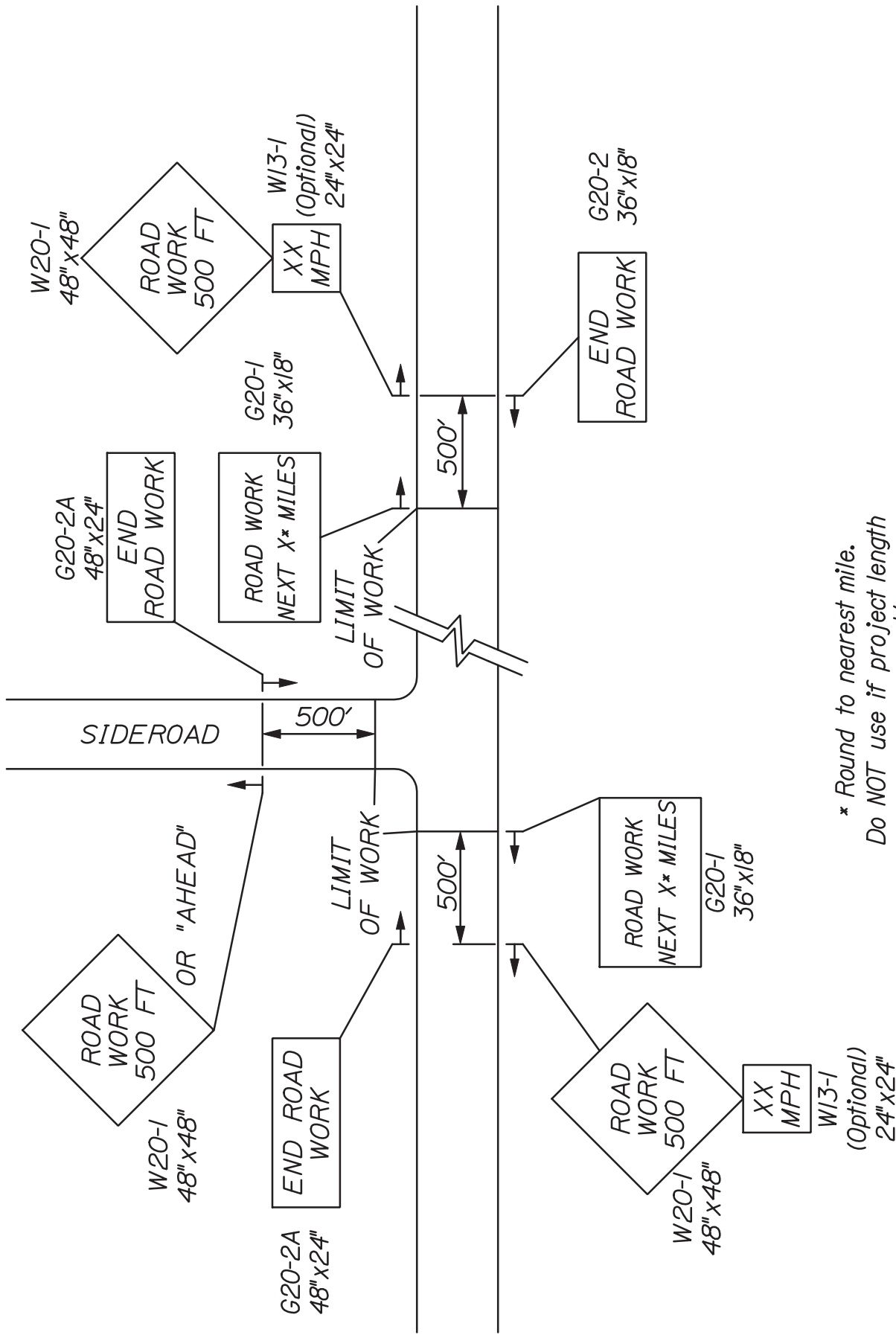

* Round to nearest mile.
 Do NOT use if project length
 is less than a 1 1/2 mile.

~ PROJECT APPROACH SIGNING ~
 TWO WAY TRAFFIC

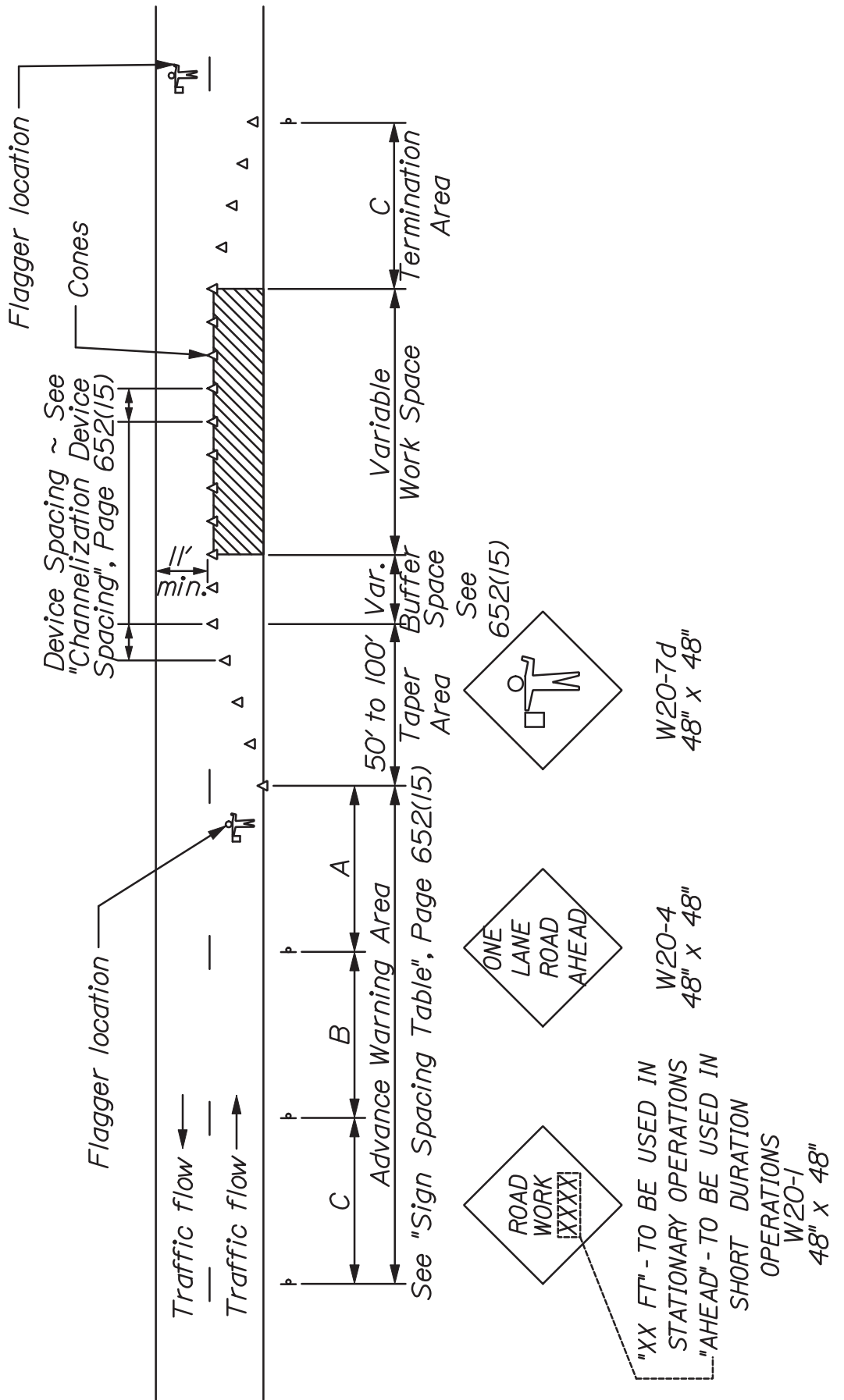

~ TYPICAL APPLICATION: TWO - WAY, TWO LANE ROADWAY,
 CLOSING ONE LANE USING FLAGGERS ~

* Formulas for L are as follows:
For speed limits of 40 mph or less:

$$L = \frac{WS^2}{60}$$

For speed limits of 45 mph or greater:

$$L = WS$$

* Formulas for L are as follows:

A minimum of 5 channelization devices shall be used in the taper.

TYPE OF TAPER	TAPER LENGTH (L)*
Merging Taper	at least L
Shifting Taper	at least 0.5 L
Shoulder Taper	at least 0.33 L
One-Lane, Two-Way Traffic Taper	100 ft maximum
Downstream Taper	100 ft per lane

CHANNELIZATION DEVICE SPACING

The spacing of channelization devices shall not exceed a distance in feet equal to 1.0 times the speed limit in mph when used for taper channelization, and a distance in feet of 2.0 times the speed limit in mph when used for tangent channelization.

GENERAL NOTES:

1. Final placement of signs and devices may be changed to fit field conditions as approved by the Resident.
2. Maintain same number of lanes for a shifting taper.
3. Shoulder taper allowed when a minimum of 10 feet can be open from centerline for lane.

Road Type	Distance Between Signs**		
	A	B	C
Urban 30 mph or less	100	100	100
Urban 35 mph and greater	350	350	350
Rural	500	500	500
Expressway / Urban Parkway	1000	1500	2640

**Distances are shown in feet.

SUGGESTED BUFFER ZONE LENGTHS

Speed (mph)	Length (feet)	Speed (mph)	Length (feet)
20	115	40	325
25	155	45	360
30	200	50	425
35	250	55	495

2020 STANDARD DETAIL UPDATES

Standard Details and Standard Detail updates are available at:
<http://maine.gov/mdot/contractors/publications/standarddetail/>

<u>Detail #</u>	<u>Description</u>	<u>Revision Date</u>
507(20)	Steel Approach Railing 3-Bar	2/11/2021
507(21)	Steel Approach Railing 3-Bar	2/11/2021
507(22)	Steel Approach Railing 3-Bar	2/11/2021
507(23)	Steel Approach Railing 3-Bar	2/11/2021
507(27)	Steel Approach Railing	2/11/2021
526(01)	Portable Concrete Barrier	1/14/2021
526(01A)	Portable Concrete Barrier	1/14/2021
526(01B)	Portable Concrete Barrier	1/14/2021
526(02)	Portable Concrete Barrier	1/14/2021
526(02A)	Portable Concrete Barrier	1/14/2021
526(03)	Portable Concrete Barrier	1/14/2021
526(04)	Portable Concrete Barrier	1/14/2021
526(04A)	Portable Concrete Barrier	1/14/2021
526(04B)	Portable Concrete Barrier	1/14/2021
606(23)	Standard Bridge Transition – Type “1”	2/11/2021
606(24)	Standard Bridge Transition – Type “1A”	2/11/2021
609(09)	Precast Concrete Vertical Curb	2/11/2021
643(11)	ATCC Cabinet	12/14/2020
802(05)	Roadway Culvert End Slope Treatment	1/03/2017

SUPPLEMENTAL SPECIFICATIONS
(Corrections, Additions, & Revisions to Standard Specifications – March 2020)

SECTION 102
BIDDING

102.11 Bid Responsiveness Revise the paragraph that states
“The Bid is not signed by a duly authorized representative of the Bidder.” So that it reads:

“The Bid is not signed by a duly authorized representative of the Bidder.

- **Properly submitted electronic bids meet this requirement.**
- **Paper bids must include at least one signed copy of the Contract Agreement Offer & Award form.”**

SECTION 104
GENERAL RIGHTS AND RESPONSIBILITIES

104.2.1 Furnishing of Right-of-Way Revise the last sentence in the first paragraph by removing
“105.4.5 – Special Detours” and replacing it with “**105.4.5 – Maintenance of Existing Structures.**”.

SECTION 106
QUALITY

106.6 Acceptance Revise this Subsection by replacing the paragraph beginning with “Acceptance of Hot Mix Asphalt Pavement will be based” with:

“Acceptance of Hot Mix Asphalt Pavement will be based on Method A or C Statistical Acceptance, or Method B or D Acceptance as specified. The method of acceptance for each item is defined in Special Provision, Section 403, Hot Mix Asphalt Pavement. When items of Hot Mix Asphalt Pavement are not so designated, Method A will be utilized whenever there are more than 1000 tons per Hot Mix Asphalt Pavement item, and Method B will be utilized when there are less than or equal to 1000 tons per Hot Mix Asphalt Pavement item.”

Revise Subsection “B” by removing it and replacing it with:

“B. Items not designated for Statistical Acceptance will utilize Method B or D Acceptance testing to validate the quality of the material incorporated into the Project. For material paid under Item 403.209 – Method D, or designated to be visually accepted, the Contractor shall provide the Department with a Certification Letter that indicates that the material supplied complies with the Specifications. Test results representative of the certified material shall be attached to the letter.

The Department will randomly sample and test the certified Material for properties noted in Table 1 of Section 502 - Structural Concrete or Table 14 of Section –401.21 Acceptance Method B & D. Material will be subject to rejection as noted in Structural Concrete Section 502.195 - Quality Assurance Method C Concrete or Hot Mix Asphalt, Section 401.2022 Pay Adjustment – Method B & D.”

106.7.1 Standard Deviation Method Revise 106.7.1, subsection H by removing the following from the first paragraph:

“Method B: $PF = [70 + (\text{Quality Level} * 0.33)] * 0.01$ ”

SECTION 110 INDEMNIFICATION, BONDING, AND INSURANCE

110.3.9 Administrative & General Provisions Amend this subsection by adding “**Automobile Liability**” under letter A) Additional Insured to the list of exceptions.

SECTION 401 HOT MIX ASPHALT PAVEMENT

401.19 Contractor Quality Control Amend this Section by adding the following to the end:
“Failure to comply with the approved QCP will result in work suspension and pay reductions as outlined in Section 106.4.6. The Quality Control Plan Value shall be the total bid value for all items covered by the QCP as identified in Special Provision 403.”

SECTION 502 STRUCTURAL CONCRETE

502.09 Forms and Falsework Amend this subsection by adding the subsection title “**502.10 Placing Concrete**” after section “D” Removal of Forms and False work” and after the paragraph beginning with “2. Forms and False work, including blocking...”. So that a new subsection starts and reads:

“502.10 Placing Concrete

A. **General Concrete shall not be placed until forms”**

502.1701 Quality Control, Method A and B Revise this Section so that the first paragraph and the first sentence of the second paragraph read:

“502.17 Quality Control. The Contractor shall control the quality of the concrete through testing, inspection, and practices which shall be described in the QCP, sufficient to assure a product meeting the Contract requirements. The QCP shall meet the requirements of Section 106, Quality, and this specification. No work under this item shall proceed until the QCP is submitted to and approved by the Department. Failure to comply with the approved QCP will result in work suspension and pay reductions as outlined in Section 106.4.6. The Quality Control Plan Value shall be the total bid value for all cast-in-place items covered by the QCP,

using the P value listed in Special Provision 502. If no P value is listed, a value of \$350, or bid value per cubic yard, whichever is less, shall be used.

502.1701 Quality Control, Method A and B The QCP shall address all elements that affect the quality of the structural concrete including, but not limited to, the following: “

502.18, Method of Measurement, Revise Subsection ‘F’ by removing the word ‘transverse’ so that it reads: “**Saw cut grooving of concrete wearing surfaces, complete and accepted, will be measured for payment as one lump sum.**”

502.19, Basis of Payment, Revise the third paragraph by removing the word ‘transverse’ so that it reads: “**Saw cut grooving of concrete wearing surfaces will be paid for at the Contract Lump Sum Price, which shall be payment for furnishing all materials, labor, and equipment, including depth gauges and all incidentals, to satisfactorily complete the work.**”

(Also see 535.24 and 535.25 for related changes)

SECTION 506 SHOP APPLIED PROTECTIVE COATING – STEEL

506.13 Surface Preparation Amend this section by adding this paragraph to the end:

“Steel shall meet the requirements of SSPC SP8 Pickling prior to being immersed in the zinc tanks. Verification of the surface preparation shall be included in the QC documentation.”

SECTION 523 BEARINGS

523.22 Fabrication Amend this subsection by adding the following: “**Elastomeric Bearings shall be fabricated in accordance with AASHTO M251.**”

SECTION 526 CONCRETE BARRIER

Amend this section by deleting it in its entirety and replacing it with:

“526.01 Description This work shall consist of the furnishing, constructing, erecting, setting, resetting, and removal of concrete barrier and associated elements in accordance with these specifications, the Standard Details, and the lines and grades shown on the Plans or established by the Resident.

The types of concrete barrier are designated as follows:

Portable Concrete Barrier Type I Double faced removable barrier in accordance with the Standard Details.

Permanent Concrete Barrier Type II Double faced barrier as shown on the Plans.

Permanent Concrete Barrier Type IIIa Single faced barrier 32 inches high in accordance with the Standard Details or as shown on the Plans.

Permanent Concrete Barrier Type IIIb Single faced barrier 42 inches high in accordance with the Standard Details or as shown on the Plans.

Permanent Concrete Transition Barrier Barrier of various heights joining steel bridge rail to steel guardrail in accordance with the Standard Details or as shown on the Plans.

Permanent Texas Classic Rail Barrier Traffic rail or sidewalk rail, in accordance with the Standard Details or as shown on the Plans.

526.02 Materials

a. **Concrete** Concrete for barriers, both permanent and portable, shall have a design strength of 5,000 psi.

For cast-in-place barrier: The concrete shall be Class LP, in accordance with Standard Specification Section 502, Structural Concrete.

For precast barrier: The concrete shall meet the requirements of Standard Specification 712.061, Structural Precast Concrete Units, except that the stripping strength for precast barriers is 4,000 psi.

b. **Reinforcing Steel** Reinforcing steel shall meet the requirements of Section 503, Reinforcing Steel.

c. **Structural Steel** Plates and barrier connections shall meet the requirements specified in Standard Specification 504 - Structural Steel and shall be hot dip galvanized after fabrication in accordance with Standard Specification 506, Shop Applied Protective Coating – Steel

d. **Bolts** Bolts shall meet the requirements specified in Section 713.02, High Strength Bolts.

e. **Connecting Pins for Portable Concrete Barrier** Portable concrete barriers must be connected using a 1- inch diameter pin. The connecting pin must be smooth, not deformed, i.e., reinforcing bar may not be used, and shall meet the strength requirements of ASTM A449 steel. Materials with greater strength may be used with the approval of the Department.

f. Anchor Pins for Portable Concrete Barrier Anchoring to concrete or asphalt will be required when specified on the Plans. When required, portable concrete barriers must be anchored using a 1 ½ - inch diameter anchor pin. The anchor pin must be smooth, not deformed, i.e., reinforcing bar may not be used, and shall meet the strength requirements of ASTM A36 steel. Materials with greater strength may be used with the approval of the Department.

g. Device Crashworthiness MaineDOT is transitioning to MASH2016 criteria for Portable Concrete Barrier on the following schedule:

New Portable Concrete Barrier shall be crash tested and/or evaluated to MASH2016 criteria.

Current Portable Concrete Barrier in useful serviceable condition that is successfully tested to NCHRP Report 350 or MASH2009 criteria may be utilized through December 31, 2029.

Other current Portable Concrete Barrier that is deemed acceptable by the Department may be utilized on projects off the National Highway System through December 31, 2024.

526.03 Construction Requirements

Cast-in-place barriers shall be fabricated in accordance with Standard Specification Section 502, Structural Concrete. Precast barriers shall be fabricated in accordance with Standard Specification 534, Precast Structural Concrete.

Concrete finish for permanent barrier shall be rubbed as defined in Standard Specification Section 502, Structural Concrete, 502.13 D2 or an approved equal.

Portable concrete barrier shall be generally free from fins and porous areas and shall present a neat and uniform appearance.

Permanent barrier shall have a protective coating applied in accordance with Standard Specification Section 515, Protective Coating for Concrete Surfaces.

Reflective delineators for concrete median barrier shall meet the requirements of Special Provision 645, Highway Signing.

Preformed Joint Filler shall meet the requirements specified in Subsection 705.01, Preformed Expansion Joint Filler.

Permissible dimensional tolerances for all concrete barriers shall be as follows:

a. Cross-sectional dimensions shall not vary from design dimensions by more than ¼ inch. The vertical centerline shall not be out of plumb by more than ¼ inch.

b. Longitudinal dimensions shall not vary from the design dimensions by more than ¼ inch per 10 feet of barrier section and shall not exceed ¾ inches per section.

c. Location of anchoring holes shall not vary by more than ½ inch from the dimensions shown in the concrete barrier details on the Plans.

d. Surface straightness shall not vary more than ¼ inch under a 10-foot straightedge.

e. The barrier shall have no significant cracking. Significant cracking is defined as fractures or cracks passing through the section, or any continuous crack extending for a length of 12 inches or more, regardless of position in the section.

526.04 Method of Measurement Permanent Concrete Barrier Type II, IIIa, IIIb, Texas Classic Rail, and Precast Median Barrier will be measured for payment by lump sum, complete in place.

Portable concrete barrier, both anchored and unanchored will be measured for payment by lump sum. Lump sum measurement will include verification of the installation and removal of all portable concrete at the completion of the Contractor's operations.

The Contractor shall replace sections of portable concrete barrier, including anchored barrier damaged by the traveling public when directed by the Resident. Replacement sections will be measured for payment in accordance with Standard Specification 109.7, Equitable Adjustments to Compensation and Time.

Transition barrier will be measured by each, complete in place.

526.05 Basis of Payment The accepted quantities of Concrete Barrier Type II, IIIa, IIIb, Texas Classic Rail, and Precast Median Barrier will be paid for at the Contract lump sum price for the type specified, complete in place.

The accepted quantities of Portable Concrete Barrier Type I, both anchored and unanchored will be paid for at the Contract lump sum price. Such payment shall be full compensation for furnishing all materials, assembling, moving, resetting, transporting, temporarily storing, removing barrier, furnishing new parts as necessary, and all incidentals necessary to complete the work.

Portable barrier shall become the property of the Contractor upon completion of the use of the barrier on the project and shall be removed from the project site by the Contractor.

Transition barrier will be paid for at the Contract price each, complete in place.

The accepted quantity of all types of concrete barrier, whether portable or permanent, will be paid for at the lump sum or per each price, as applicable, which payment shall be full compensation for all materials, including reinforcing steel, protective coating, reflective

delineators, steel plates and hardware, equipment, labor and incidentals required, as necessary, to complete the work.

Payment will be made under:

	<u>Pay Item</u>	<u>Pay Unit</u>
526.301	Portable Concrete Barrier, Type I	Lump Sum
526.304	Portable Concrete Barrier, Anchored Type I	Lump Sum
526.312	Permanent Concrete Barrier Type II	Lump Sum
526.321	Permanent Concrete Barrier Type IIIa	Lump Sum
526.323	Texas Classic Rail	Lump Sum
526.331	Permanent Concrete Barrier Type IIIb	Lump Sum
526.34	Permanent Concrete Transition Barrier	Each
526.502	Precast Concrete Median Barrier	Lump Sum”

SECTION 527
ENERGY ABSORBING UNIT

527.02 Materials Amend this section by deleting it in its entirety and replacing it with:

“MaineDOT is transitioning to MASH2016 criteria for Work Zone Traffic Control Devices on the following schedule:

Portable Crash Cushions will be crash tested and/or evaluated to MASH2016 criteria by January 1, 2030. Current Category 3 devices in useful serviceable condition that are successfully tested to NCHRP Report 350 or MASH2009 criteria may be utilized through December 31, 2029.

Work Zone Crash Cushions shall be selected from the Department’s Qualified Products List of Crash Cushions/Impact Attenuators or approved equal.”

SECTION 535
PRECAST, PRESTRESSED CONCRETE SUPESTRUCTURE

535.24, Installation of Slabs, Beams, and Girders Revise the 5th paragraph by replacing “6.0 and 9.0” to “5.0 and 8.0” so it reads: **“Ready mixed grout shall achieve a design compressive strength of 6,000 psi at 28 days, have an entrained air content of between 5.0 and 8.0 percent, be non-shrink, flowable, and contain a non-shrink additive listed on the Department QPL for expansive cements.”**

535.25, Installation of Precast/Prestressed Deck Panels Revise the 2nd paragraph by replacing “6.0 and 9.0” to “5.0 and 8.0” so it reads: **“Ready mixed grout shall achieve a design compressive strength of 6,000 psi at 28 days, have an entrained air content of between 5.0 and 8.0 percent, be non-shrink, flowable, and contain a non-shrink additive listed on the Department QPL for expansive cements.”**

SECTION 606 GUARDRAIL

Amend this section by replacing it with the following:

606.01 Description This work shall consist of furnishing and installing guardrail components in accordance with these specifications and in reasonably close conformity with the lines and grades shown on the plans or as established. Guardrail is designated as:

31” W-Beam Guardrail - Mid-Way Splice

Galvanized steel w-beam, 8” wood or composite offset blocks, galvanized steel posts

Thrie Beam

Galvanized steel thrie beam, 8” wood or composite offset blocks, galvanized steel posts

Median guardrail shall consist of two beams of the above types, mounted on single posts.

Bridge mounted guardrail shall consist of furnishing all labor, materials, and equipment necessary to install guardrail as shown on the plans. This work shall also include drilling for and installation of offset blocks if specified, and incidental hardware necessary for satisfactory completion of the work.

Remove and Reset and Remove, Modify, and Reset guardrail shall consist of removing the existing designated guardrail and resetting in a new location as shown on the plans or directed by the Resident. Remove, Modify, and Reset guardrail and Modify guardrail include the following guardrail modifications: Removing plate washers at all posts, except at anchorage assemblies as noted on the Standard Details, adding offset blocks, and other modifications as listed in the Construction Notes or General Notes. Modifications shall conform to the guardrail Standard Details.

Bridge Connection shall consist of the installation and attachment of beam guardrail to the existing bridge. This work shall consist of constructing a concrete end post or modifying an existing end post as required, furnishing, and installing a terminal connector, necessary hardware, and incidentals required to complete the work as shown on the plans. Bridge Transition shall consist of a bridge connection and furnishing and installing guardrail components as shown in the Standard Details.

606.02 Materials Materials shall meet the requirements specified in the following Sections of Division 700 - Materials:

Timber Preservative	708.05
Metal Beam Rail	710.04
Guardrail Posts	710.07
Guardrail Hardware	710.08

Guardrail components shall meet the applicable standards of "A Guide to Standardized Highway Barrier Hardware" prepared and approved by the AASHTO-AGC-ARTBA Joint Cooperative Committee, Task Force 13 Report.

Posts for underdrain delineators shall be "U" channel steel, 8 ft long, 2 ½ lb/ft minimum and have 3/8-inch round holes, 1-inch center to center for a minimum distance of 2 ft from the top of the post.

Reflectorized Flexible Guardrail Markers shall be mounted on all guardrails. A marker shall be mounted onto guardrail posts at the flared guardrail terminal end point and tangent point, both at the leading and trailing ends of each run of guardrail. The marker's flexible posts shall be gray with either silver-white or yellow reflectors (to match the edge line striping) at the tangents, red at leading ends, and green at trailing ends. Whenever the guardrail terminal is not flared, markers will only be required at the terminal end point. These shall be red or green as appropriate. Markers shall be installed on the protected side of guardrail posts unless otherwise approved by the Resident. Reflectorized flexible guardrail markers shall be from the Department's Qualified Products List of Delineators. The marker shall be gray, flexible, durable, and of a non-discoloring material to which 3-inch by 9-inch reflectors shall be applied, and capable of recovering from repeated impacts and meeting MASH 16 requirements. Reflective material shall meet the requirements of Section 719.01 for ASTM D 4956 Type III reflective sheeting. The marker shall be secured to the guardrail post with two fasteners, as shown in the Standard Details.

Reflectorized beam guardrail ("butterfly"-type) delineators shall be mounted on all "w"-beam guardrail. The delineators shall be mounted within the guardrail beam at guardrail posts. Delineators shall be fabricated from high-impact, ultraviolet & weather resistant thermoplastic. Reflectorized beam guardrail delineators shall be placed at approximately 62.5 ft intervals or every tenth post on tangents and at approximately 31.25 ft intervals or every fifth post on curves. Exact locations of the delineators shall be as directed by the Resident. On divided highways, the left-hand delineators shall be yellow, and the right-hand delineators shall be silver/white. On two directional highways, the right-hand side shall be silver/white, and no reflectorized delineator used on the left. All reflectors shall have reflective sheeting applied to only one side of the delineator facing the direction of traffic as shown in the Standard Details. Reflectorized sheeting for guardrail delineators shall meet the requirements of Section 719.01.

Single wood post shall be of cedar, white oak, or tamarack, well-seasoned, straight, and sound and have been cut from live trees. The outer and inner bark shall be removed, and all knots trimmed flush with the surface of the post. Posts shall be uniform taper and free of kinks and bends.

Single steel post shall conform to the requirements of Section 710.07 b.

Single steel pipe post shall be galvanized, seamless steel pipe conforming to the requirements of ASTM A120, Schedule No. 40, Standard Weight.

Acceptable multiple mailbox assemblies shall be listed on the Department's Qualified Products List and shall be MASH 16 tested and approved.

Flared and Tangent w-beam guardrail terminals and guardrail offset blocks shall be from the Department's Qualified Products List. Flared terminals shall be installed with a 4 ft offset as shown in the Manufacturer's installation instructions.

Anchorage assemblies used to anchor trailing ends, radius guardrail, or other ends not exposed to traffic shall meet the applicable standards of "A Guide to Standardized Highway Barrier Hardware" prepared and approved by the AASHTO-AGC-ARTBA Joint Cooperative Committee, Task Force 13 Report, Drawing SEW02a.

Existing materials damaged or lost during adjusting, removing and resetting, or removing, modifying, and resetting, shall be replaced by the Contractor without additional compensation. Existing guardrail posts and guardrail beams found to be unfit for reuse shall be replaced when directed by the Resident.

606.03 Posts Posts for guardrail shall be set plumb in holes or they may be driven if suitable driving equipment is used to prevent battering and distorting the post. When posts are driven through pavement, the damaged area around the post shall be repaired with approved bituminous patching. Damage to lighting and signal conduit and conductors shall be repaired by the Contractor.

When set in holes, posts shall be on a stable foundation and the space around the posts, backfilled in layers with suitable material, thoroughly tamped.

The reflectorized flexible guardrail markers shall be set plumb with the reflective surface facing the oncoming traffic. Markers shall be installed on the protected side of guardrail posts. Markers, which become bent or otherwise damaged, shall be removed and replaced with new markers.

Single wood posts shall be set plumb in holes and backfilled in layers with suitable material, thoroughly tamped. The Resident will designate the elevation and shape of the top. The posts, that are not pressure treated, shall be painted two coats of good quality oil base exterior house paint.

Single steel posts shall be set plumb in holes as specified for single wood posts or they may be driven if suitable driving equipment is used to prevent battering and distorting the post.

Additional bolt holes required in existing posts shall be drilled or punched, but the size of the holes shall not exceed the dimensions given in the Standard Details. Metal around the holes shall be thoroughly cleaned and painted with two coats of approved aluminum rust resistant paint. Holes shall not be burned.

606.04 Rails Brackets and fittings shall be placed and fastened as shown on the plans. Rail beams shall be erected and aligned to provide a smooth, continuous barrier. Beams shall be lapped with the exposed end away from approaching traffic.

End assemblies shall be installed as shown on the plans and shall be securely attached to the rail section and end post.

All bolts shall be of sufficient length to extend beyond the nuts but not more than ½ inch. Nuts shall be drawn tight.

Additional bolt holes required in existing beams shall be drilled or punched, but the size of the holes shall not exceed the dimensions given in the Standard Details. Metal around the holes shall be thoroughly cleaned and painted with two coats of approved aluminum rust resistant paint. Holes shall not be burned.

606.045 Offset Blocks The same offset block material is to be provided for the entire project unless otherwise specified.

606.05 Shoulder Widening At designated locations the existing shoulder of the roadway shall be widened as shown on the plans. All grading, paving, seeding, and other necessary work shall be in accordance with the Specifications for the type work being done.

606.06 Mail Box Post Single wood post shall be installed at the designated location for the support of the mailbox. The multiple mailbox assemblies shall be installed at the designated location in accordance with the Standard Details and as recommended by the Manufacturer. Attachment of the mailbox to the post will be the responsibility of the home or business owner.

606.07 Abraded Surfaces All galvanized surfaces of new guardrail and posts, which have been abraded so that the base metal is exposed, and the threaded portions of all fittings and fasteners and cut ends of bolts shall be cleaned and painted with two coats of approved rust resistant paint.

606.08 Method of Measurement Guardrail will be measured by the linear foot from center to center of end posts along the gradient of the rail except where end connections are made to masonry or steel structures, in which case measurement will be as shown on the plans. When connected to radius rail, measurement will be to the end of the last tangent beam.

Guardrail terminal, reflectorized flexible guardrail marker, terminal end, anchorage assembly, bridge transition, bridge connection, multiple mailbox post, and single post will be measured by each unit of the kind specified and installed.

Widened shoulder will be measured as a unit of grading within the limits shown on the plans.

Excavation in solid rock for placement of posts will be paid under force account unless otherwise indicated in the Bid Documents.

606.09 Basis of Payment The accepted quantities of guardrail will be paid for at the contract unit price per linear foot for the type specified, complete in place. Reflectorized beam guardrail

("butterfly"-type) delineators will not be paid for directly but will be considered incidental to guardrail items. Reflectorized flexible guardrail marker, terminal end, anchorage assembly, bridge transition, bridge connection, multiple mailbox post, and single post will be paid for at the contract unit price each for the kind specified complete in place.

Guardrail terminals will be paid for at the contract price each, complete in place which price shall be full payment for furnishing and installing all components including the terminal section, posts, offset blocks, "w" beam, cable foundation posts, plates and for all incidentals necessary to complete the installation within the limits as shown on the Standard Details or the Manufacturer's installation instructions. Pay limits for a flared terminal will be 37.5 feet. Pay limits for a tangent terminal will be 50 feet. Each guardrail terminal will be clearly marked with the Manufacturer's name and model number to facilitate any future needed repair. Such payment shall also be full compensation for furnishing all material, excavating, backfilling holes, assembling, and all incidentals necessary to complete the work, except that for excavation for posts or anchorages in solid ledge rock, payment will be made under 109.7.5 – Force Account. Type III Retroreflective Adhesive Sheeting shall be applied to the approach buffer end sections and sized to substantially cover the end section. On all roadways, the ends shall be marked with alternating black and retroreflective yellow stripes. The stripes shall be 3 in wide and sloped down at an angle of 45 degrees toward the side on which traffic is to pass the end section. Guardrail terminals shall also include a set of installation drawings supplied to the Resident.

Anchorage to bridge end posts will be part of the bridge work. Connections thereto will be considered included in the unit bid price for guardrail.

Guardrail to be placed on a radius of curvature of 150 ft or less will be paid for under the designated radius pay item for the type guardrail being placed.

Widened shoulder will be paid for at the contract unit price each complete in place and will be full compensation for furnishing and placing, grading and compaction of aggregate subbase and any required fill material.

Adjust guardrail will be paid for at the contract unit price per linear foot and will be full compensation for adjusting to grade. Payment shall also include adjusting guardrail terminals where required.

Modify guardrail will be paid for at the contract unit price per linear foot and will be full compensation for furnishing and installing offset blocks, additional posts, and other specified modifications; removing, modifying, installing, and adjusting to grade existing posts and beams; removing plate washers and backup plates, and all incidentals necessary to complete the work. Payment shall also include removing and resetting guardrail terminals where required.

Remove and Reset guardrail will be paid for at the contract unit price per linear foot and will be full compensation for removing, transporting, storing, reassembling all parts, necessary cutting, furnishing new parts when necessary, reinstalling at the new location, and all other incidentals necessary to complete the work. Payment shall also include removing and resetting guardrail terminals when required.

Remove, Modify, and Reset guardrail will be paid for at the contract unit price per foot and will be full compensation for the requirements listed in Modify guardrail and Remove and Reset guardrail.

Bridge Connections will be paid for at the contract unit price each. Payment shall include, attaching the connection to the endpost including furnishing and placing concrete and reinforcing steel necessary to construct new endposts if required, furnishing and installing the terminal connector, and all miscellaneous hardware, labor, equipment, and incidentals necessary to complete the work.

Bridge Transitions will be paid for at the contract unit price each. Payment shall include furnishing and installing the thrie beam or “w”-beam terminal connector, doubled beam section, and transition section, where called for, posts, hardware, precast concrete transition curb, and any other necessary materials and labor, including the bridge connection as stated in the previous paragraph.

No payment will be made for guardrail removed, but not reset and all costs for such removal shall be considered incidental to the various contract pay items.

Payment will be made under:

<u>Pay Item</u>	<u>Pay Unit</u>
606.1301 31” W-Beam Guardrail - Mid-Way Splice – Single Faced	Linear Foot
606.1302 31” W-Beam Guardrail - Mid-Way Splice – Double Faced	Linear Foot
606.1303 31” W-Beam Guardrail - Mid-Way Splice, 15’ Radius and Less	Linear Foot
606.1304 31” W-Beam Guardrail - Mid-Way Splice, Over 15’ Radius	Linear Foot
606.1305 31” W-Beam Guardrail - Mid-Way Splice Flared Terminal	Each
606.1306 31” W-Beam Guardrail - Mid-Way Splice Tangent Terminal	Each
606.1307 Bridge Transition (Asymmetrical) – Type IA	Each
606.1721 Bridge Transition - Type I	Each
606.1722 Bridge Transition - Type II	Each
606.1731 Bridge Connection - Type I	Each
606.1732 Bridge Connection - Type II	Each
606.178 Guardrail Beam	Linear Foot
606.25 Terminal Connector	Each
606.257 Terminal Connector - Thrie Beam	Each
606.259 Anchorage Assembly	Each
606.265 Terminal End-Single Rail - Galvanized Steel	Each
606.266 Terminal End-Single Rail - Corrosion Resistant Steel	Each
606.275 Terminal End-Double Rail - Galvanized Steel	Each
606.276 Terminal End-Double Rail - Corrosion Resistant Steel	Each
606.353 Reflectorized Flexible Guardrail Marker	Each
606.354 Remove and Reset Reflectorized Flexible Guardrail Marker	Each
606.356 Underdrain Delineator Post	Each
606.358 Guardrail, Modify	Linear Foot
606.362 Guardrail, Adjust	Linear Foot
606.365 Guardrail, Remove, Modify, and Reset	Linear Foot
606.366 Guardrail, Remove and Reset	Linear Foot

606.367	Replace Unusable Existing Guardrail Posts	Each
606.47	Single Wood Post	Each
606.48	Single Galvanized Steel Post	Each
606.50	Single Steel Pipe Post	Each
606.51	Multiple Mailbox Support	Each
606.568	Guardrail, Modify - Double Rail	Linear Foot
606.63	Thrie Beam Rail Beam	Linear Foot
606.64	Guardrail Thrie Beam - Double Rail	Linear Foot
606.65	Guardrail Thrie Beam - Single Rail	Linear Foot
606.66	Terminal End Thrie Beam	Each
606.70	Transition Section - Thrie Beam	Each
606.71	Guardrail Thrie Beam - 15 ft radius and less	Linear Foot
606.72	Guardrail Thrie Beam - over 15 ft radius	Linear Foot
606.73	Guardrail Thrie Beam - Single Rail Bridge Mounted	Linear Foot
606.74	Guardrail - Single Rail Bridge Mounted	Linear Foot
606.753	Widen Shoulder for Low Volume Guardrail End	Each
606.754	Widen Shoulder for Flared Guardrail Terminal	Each
606.78	Low Volume Guardrail End	Each
606.80	Buried-in-Slope Guardrail End	Each

SECTION 609 CURB

609.02 Materials Revise the paragraph beginning “The Contractor shall submit a concrete mix...” so that it reads:

“The Contractor shall submit a concrete mix design for the Portland Cement Concrete to the Resident, with a minimum designed compressive strength of 3000 psi concrete fill.”

609.03 Vertical Stone Curb, Terminal Section and Transition Sections and Portland Cement Concrete Curb, Terminal Sections and Transition Sections Revise this section by underlining the section number and title so that it reads in the spec book as:

“609.03 Vertical Stone Curb, Terminal Section and Transition Sections and Portland Cement Concrete Curb, Terminal Sections and Transition Sections”

Revise the last paragraph beginning with “The Contractor may elect...” so that it reads:

“The Contractor may elect to substitute concrete to backfill Stone Curbing or Stone Edging at their option. If the concrete backfill option is elected, the Concrete Fill shall meet the requirements of 609.02.”

SECTION 610

STONE FILL, RIPRAP, STONE BLANKET, AND STONE DITCH PROTECTION

610.02 Materials Amend this subsection by adding the following to the end of the material list:
“**Stone Ditch Protection 703.29**”

SECTION 618

SEEDING

618.08 Mulching Revise this Section so that the third sentence reads: “Mulch for Seeding Method Number 1 shall only be cellulosic fiber mulch Section 619.04 (b) or straw mulch Section 619.04 (a).”

SECTION 626

FOUNDATIONS, CONDUIT, AND JUNCTION BOXES FOR HIGHWAY
SIGNING, LIGHTING, AND SIGNALS

626.034 Concrete Foundations Revise this Section by changing ‘626.037’ to ‘**626.036**’ in the Second Paragraph which begins with “Foundations shall consist of cast-in-place...”.

Revise the 10th paragraph beginning with “Before placing concrete, the required elbows...” by removing “...in accordance with **Standard Specification 633.**”

SECTION 627

PAVEMENT MARKINGS

627.06 Application Revise this subsection by replacing the paragraph beginning with “ On other final pavement markings...” with the following:

“On other final pavement markings and on curb, where the paint is applied by hand painting or spraying, application shall be one uniform covering coat at least 16 mils thick. Before the paint has dried, the glass beads shall be applied by a pressure system that will force the glass beads onto the undried paint as uniformly as possible.

Painted lines and markings shall be applied in accordance with the manufacturer’s published recommendations. These recommendations will be supplied to the Resident prior to installation.”

SECTION 643 TRAFFIC SIGNALS

643.021 Materials Amend this subsection by adding the following at the end:

“MaineDOT is transitioning to MASH2016 criteria for Work Zone Traffic Control Devices on the following schedule:

Temporary Traffic Control Signals will be crash tested and/or evaluated to MASH2016 criteria by January 1, 2030. Current Category 4 devices in useful serviceable condition that are successfully tested to NCHRP Report 350 or MASH2009 criteria may be utilized through December 31, 2029.”

643.09 Service Connection Revise this subsection by removing the paragraph that begins with “Traffic signal services shall have...”.

And by removing the paragraphs beginning with “ A service ground rod shall be installed...” and “A total of 4, 10’ service...” and replace them with **“A total of 4, 10’ service ground rods shall be installed and properly connected together on the outside of the cabinet foundation. One ground rod shall be located at each corner and shall be either flush or slightly below finished grade. The connection between the ground rod and the ground wire shall be an exothermic connection such as a Cadweld. The ground wire from the interconnected ground rods shall be routed through a conduit in the foundation and into the base of the cabinet”**.

SECTION 645 HIGHWAY SIGNING

Section 645.023 Sign Support Structures. Under letter “c.”, revise the fifth paragraph beginning with “In addition to the required details...” by removing the words **”and foundation”** from the 5th sentence.

Section 645.08 Method of Measurement. Revise the second paragraph beginning with “Bridge-type, cantilever and...” by removing the words **”including the foundation”** .

Section 645.09 Basis of Payment. Revise the third paragraph beginning with “The accepted bridge-type, cantilever and...” by removing the word **”foundation”** from the second sentence. Add the following sentence to the end of the paragraph **“Conduits, Junction Boxes, and Foundations will be paid for under Section 626.”**

SECTION 652
MAINTENANCE OF TRAFFIC

Amend this Section by adding the following new subsection:

“652.2.6 Device Crashworthiness MaineDOT is transitioning to MASH2016 criteria for Work Zone Traffic Control Devices on the following schedule:

Category 1 (Cones, Drums, Tubular Markers, Flexible Delineators, and similar devices that have little chance of causing windshield penetration, tire damage, or other significant effect on the control or trajectory of a vehicle) – All Category 1 devices will be manufacturer self-certified as MASH2016 by January 1, 2025. Current Category 1 devices in useful serviceable condition that are not self-certified as MASH2016 compliant may be utilized through December 31, 2024.

Category 2 (Barricades, Portable Sign Supports, Category 1 devices with attachments, and similar devices that are not expected to produce significant vehicular velocity change but may be otherwise hazardous) – All Category 2 devices will be crash tested and/or evaluated to MASH2016 criteria by January 1, 2025. Current Category 2 devices in useful serviceable condition that are successfully tested to NCHRP Report 350 or MASH2009 criteria may be utilized through December 31, 2024.

Category 3 (Portable Concrete Barrier, Portable Crash Cushions, Truck Mounted Attenuators, Category 2 devices weighing more than 100 pounds, and similar devices that are expected to produce significant vehicular velocity change or other harmful reactions) – All Category 3 devices will be crash tested and/or evaluated to MASH2016 criteria by January 1, 2030. Current Category 3 devices in useful serviceable condition that are successfully tested to NCHRP Report 350 or MASH2009 criteria may be utilized through December 31, 2029. (See Standard Specification 526 for additional Portable Concrete Barrier information).

Category 4 (Trailer Mounted Devices: Arrow Boards, Temporary Traffic Control Signals, Area Lighting, Portable Changeable Message Sign, and other similar devices.) – All Category 4 devices will be crash tested and/or evaluated to MASH2016 criteria by January 1, 2030. Current Category 4 devices in useful serviceable condition that are successfully tested to NCHRP Report 350 or MASH2009 criteria may be utilized through December 31, 2029.”

652.4 Flaggers Revise the first paragraph of this section so that it reads:

“The Contractor shall furnish flaggers as required by the TCP or as otherwise specified by the Resident. All flaggers must have successfully completed a flagger test approved by the Department and administered by a Department-approved Flagger-Certifier who is employing that flagger. All flaggers must carry an official certification card with them while flagging that has been issued by their employer.”

SECTION 681
PRECAST AGGREGATE-FILLED, CONCRETE BLOCK GRAVITY WALL

681.08 Basis of Payment Amend this section by adding the Item Number “**681.10**” in front of the item “Precast Aggregate-Filled Concrete Block Gravity Wall” at the end of the section.

SECTION 703
AGGREGATES

Add the following to Section 703 - Aggregates

703.01 Fine Aggregate for Concrete Fine aggregate for concrete shall consist of natural sand or, when approved by the Resident, other inert materials with similar characteristics or combinations thereof, having strong, durable particles. Fine aggregate from different sources of supply shall not be mixed or stored in the same pile nor used alternately in the same class of construction or mix without permission of the Resident.

All fine aggregate shall be free from injurious amounts of organic impurities. Should the fine aggregate, when subjected to the colorimetric test for organic impurities, AASHTO T 21, produce a color darker than the reference standard color solution (laboratory designation Plate III), the fine aggregate shall be rejected.

Fine aggregate shall have a sand equivalent value of not less than 75 when tested in accordance with AASHTO T 176.

Fine aggregate sources shall meet the Alkali Silica Reactivity (ASR) requirements of Section 703.0201.

The fineness modulus shall not be less than 2.26 or more than 3.14. If this value is exceeded, the fine aggregate will be rejected unless suitable adjustments are made in proportions of coarse and fine aggregate. The fineness modulus of fine aggregate shall be determined by adding the cumulative percentages of material by weight retained on the following sieves: Nos. 4, 8, 16, 30, 50, 100 and dividing by 100.

Fine aggregate, from an individual source when tested for absorption as specified in AASHTO T 84, shall show an absorption of not more than 2.3 percent.

Sieve Designation	Percentage by Weight Passing Square Mesh Sieves
3/8 inch	100
No. 4	95-100
No. 8	80-100
No. 16	50-85
No. 30	25-60
No. 50	10-30
No. 100	2-10
No. 200	0-5.0

703.02 Coarse Aggregate for Concrete Coarse aggregate for concrete shall consist of crushed stone or gravel having hard, strong, durable pieces, free from adherent coatings and of which the composite blend retained on the 3/8 inch sieve shall contain no more than 15 percent, by weight of flat and elongated particles when performed in accordance with test method ASTM D 4791, Flat Particles, Elongated Particles, or Flat and Elongated Particles in Coarse Aggregate, using a dimensional ratio of 1:5.

The coarse aggregate from an individual source shall have an absorption no greater than 2.0 percent by weight determined in accordance with AASHTO T 85 modified for weight of sample.

The composite blend shall have a Micro-Deval value of 18.0 percent or less as determined by AASHTO T 327 or not exceed 40 percent loss as determined by AASHTO T 96.

Coarse aggregate sources shall meet the Alkali Silica Reactivity (ASR) requirements of Section 703.0201.

Coarse aggregate shall conform to the requirements of the following table for the size or sizes designated and shall be well graded between the limits specified.

Sieve Designation	Percentage by Weight Passing Square Mesh Sieves			
	A	AA	S	LATEX
Grading	A	AA	S	LATEX
Aggregate Size	1 inch	3/4 inch	1 1/2 inch	1/2 inch
2 inch			100	
1 1/2 inch	100		95-100	
1 inch	95-100	100	-	
3/4 inch	-	90-100	35-70	100
1/2 inch	25-60	-	-	90-100
3/8 inch	-	20-55	10-30	40-70
No. 4	0-10	0-10	0-5	0-15
No. 8	0-5	0-5	-	0-5
No. 16	-	-	-	-
No. 50	-	-	-	-
No. 200	0 - 1.5	0 - 1.5	0 - 1.5	0 - 1.5

703.0201 Alkali Silica Reactive Aggregates All coarse and fine aggregates proposed for use in concrete shall be tested for Alkali Silica Reactivity (ASR) potential under AASHTO T 303 (ASTM C 1260), Accelerated Detection of Potentially Deleterious Expansion of Mortar Bars Due to Alkali-Silica Reaction, prior to being accepted for use. Acceptance will be based on testing performed by an accredited independent lab submitted to the Department. Aggregate submittals will be required on a 5-year cycle, unless the source or character of the aggregate in question has changed within 5 years from the last test date.

As per AASHTO T 303 (ASTM C 1260): Use of a particular coarse or fine aggregate will be allowed with no restrictions when the mortar bars made with this aggregate expand less than or equal to 0.10 percent at 30 days from casting. Use of a particular coarse or fine aggregate will be classified as potentially reactive when the mortar bars made with this aggregate expand greater than 0.10 percent at 30 days from casting. Use of this aggregate will only be allowed with the use of cement-pozzolan blends and/or chemical admixtures that result in mortar bar expansion of less than 0.10 percent at 30 days from casting as tested under ASTM C 1567.

Acceptable pozzolans and chemical admixtures that may be used when an aggregate is classified as potentially reactive include, but are not limited to the following:

- a. Class F Coal Fly Ash meeting the requirements of AASHTO M 295
- b. Ground Granulated Blast Furnace Slag (Grade 100 or 120) meeting the requirements of AASHTO M 302
- c. Densified Silica Fume meeting the requirements of AASHTO M 307
- d. Lithium-based admixtures
- e. Metakaolin

Pozzolans or chemical admixtures required to offset the effects of potentially reactive aggregates will be incorporated into the concrete at no additional cost to the Department.

703.05 Aggregate for Sand Leveling Aggregate for sand leveling shall be sand of hard durable particles free from vegetable matter, lumps or balls of clay and other deleterious substances. The aggregate shall meet the grading requirements of the following table.

Sieve Designation	Percentage by Weight Passing Square Mesh Sieves
3/8 inch	85-100
No. 200	0-5.0

703.06 Aggregate for Base and Subbase The following shall apply to Sections (a.) and (c.) below. The material shall have a Micro-Deval...” and replace with “The material shall have a minimum degradation value of 25.0 or less¹⁵ as determined by AASHTO T 327. If the Micro-Deval value exceeds 25.0, the Washington State Degradation DOT Test Method T 113T113, Method of Test for Determination of Degradation Value (January 2009 version) shall be performed), except that the test shall be performed on the reported degradation value will be the result of testing a single specimen from that portion of the sample that passes the 1/2 in sieve and is retained on the No. 10

sieve. If the material has a Washington Degradation value of less than 15, the material shall be rejected.

The material, minus any reclaimed asphalt pavement used in Section (b.) below shall have a Micro-Deval value of 25.0 or less as determined by AASHTO T 327. If the Micro-Deval value exceeds 25.0 the material may be used if it does not exceed 25 percent loss on AASHTO T 96, Resistance to Degradation of Small-Size Coarse Aggregate by Abrasion and Impact in the Los Angeles Machine. If AASHTO T 96 is used for acceptance of the material, the material shall be retested at intervals of 25%, 50% and 75% completion of the course.

Recycled Asphalt Pavement (RAP) shall not be used for or blended with aggregate base or subbase.

- a. Aggregate for base, Type A and B shall be crushed ledge or crushed gravel of hard durable particles free from vegetable matter, lumps or balls of clay and other deleterious substances. The gradation of the part that passes a 3 inch sieve shall meet the grading requirements of the following table:

Sieve Designation	Percentage by Weight Passing Square Mesh Sieves	
	Type A	Type B
½ inch	45-70	35-75
¼ inch	30-55	25-60
No. 40	0-20	0-25
No. 200	0-6.0	0-6.0

At least 50 percent by weight of the material retained on the No. 4 sieve shall have at least one fractured face as tested by AASHTO T 335.

Type A aggregate for base shall only contain particles of rock that will pass the 2 inch square mesh sieve.

Type B aggregate for base shall only contain particles of rock that will pass the 4 inch square mesh sieve.

- b. Aggregate for base, Type C shall be crushed ledge or crushed gravel of hard durable particles free from vegetable matter, lumps or balls of clay and other deleterious substances. The material shall meet the grading requirements of the following table:

Sieve Designation	Percentage by Weight Passing Square Mesh Sieves	
	Type C	
4 inches	100	
3 inches	90-100	
2 inches	75-100	
1 inch	50-80	
½ inch	30-60	
No. 4	15-40	
No. 200	0-6.0	

At least 50 percent by weight of the material coarser than the No. 4 sieve shall have at least one fractured face as tested by AASHTO T 335.

c. Aggregate for subbase shall be sand or gravel of hard durable particles free from vegetable matter, lumps or balls of clay and other deleterious substances. The gradation of the part that passes a 3 inch sieve shall meet the grading requirements of the following table:

Sieve Designation	Percentage by Weight Passing Square Mesh Sieves	
	Type D	Type E
½ in	35-80	
¼ inch	25-65	25-100
No. 40	0-30	0-50
No. 200	0-7.0	0-7.0

Type D aggregate for subbase gravel may contain up to 50 percent by weight Recycled Concrete Aggregate (RCA). When RCA is used, the portion of the resulting blend of gravel and RCA retained on a ½” square mesh sieve shall contain a total of no more than 5 percent by weight of other recycled materials such as brick, concrete masonry block, or asphalt pavement as determined by visual inspection.

RCA shall be substantially free of wood, metal, plaster, and gypsum board as defined in Note 9 in Section 7.4 of AASHTO M 319. RCA shall also be free of all substances that fall under the category of solid waste or hazardous materials.

Aggregate for subbase shall not contain particles of rock which will not pass the 6 inch square mesh sieve.

703.08 Recycled Asphalt Pavement Recycled asphalt pavement shall consist of salvaged asphalt materials from milled pavements or production waste that has been processed before use to meet

the requirements of the job mix formula. It shall be free of winter sand, granular fill, construction debris, or other materials not generally considered asphalt pavement.

703.081 RAP for Asphalt Pavement Recycled Asphalt Pavement (RAP) may be introduced into hot-mix asphalt pavement at percentages approved by the Department according to the MaineDOT Policies and Procedures for HMA Sampling and Testing.

If approved by the Department, the Contractor shall provide documentation stating the source, test results for average residual asphalt content, and stockpile gradations showing RAP materials have been sized to meet the maximum aggregate size requirements of each mix designation. The Department will obtain samples for verification and approval prior to its use.

The maximum allowable percent of RAP shall be determined by the asphalt content, the percent passing the 0.075 mm sieve, the ratio between the percent passing the 0.075 mm sieve and the asphalt content, and Coarse Micro-Deval loss values as tested by the Department.

The maximum percentage of RAP allowable shall be the lowest percentage as determined according to Table 4 below:

Classification	Maximum RAP Percentage Allowed	Asphalt content standard deviation	Percent passing 0.075 mm sieve standard deviation	Percent passing 0.075 mm sieve / asphalt content ratio	Residual aggregate M-D loss value
Class III	10%	≤ 1.0	N/A	≤ 4.0	≤ 18
Class II	20%	≤ 0.5	≤ 1.0	≤ 2.8	
Class I	30%	≤ 0.3	≤ 0.5	≤ 1.8	

Table 4: Maximum Percent RAP According to Test Results

The Department will monitor RAP asphalt content and gradation during production by testing samples from the stockpile at approximately 15,000 T intervals (in terms of mix production). The allowable variance limits (from the numerical average values used for mix designs) for this testing are determined based upon the maximum allowable RAP percentage and are shown below in Table 5.

Table 5: RAP Verification Limits

Classification	Asphalt content (compared to aim)	Percent passing 0.075 mm sieve (compared to aim)
Class III	± 1.5	± 2.0
Class II	± 1.0	± 1.5
Class I	± 0.5	± 0.7

For specification purposes, RAP will be categorized as follows:

Class III – A maximum of 10.0 percent of Class III RAP may be used in any base, intermediate base, surface, or shim mixture. A maximum of 20.0 percent of Class III RAP may be used in hand-placed mixes for item 403.209.

Class II – A maximum of 20.0 percent Class II RAP in any base, binder, surface, or shim course.

Class I – A maximum of 20.0 percent Class I RAP may be used in any base, intermediate base, surface, or shim mixture without requiring a change to the specified asphalt binder. A maximum of 30.0 percent Class I RAP may be used in in any base or intermediate base mixture provided that a PG 58-28 or PG 58-34 asphalt binder is used. A maximum of 30.0 percent Class I RAP may be used in any surface or shim mixture provided that PG 58-34 asphalt binder is used. Mixtures exceeding 20.0 percent Class I RAP must be evaluated and approved by the Department.

The Contractor may use up to two different RAP sources in any one mix design. The total RAP percentage of the mix shall not exceed the maximum allowed for the highest classification RAP source used (i.e. if a Class I & Class III used, total RAP must not exceed 30.0%). The blended RAP material must meet all the requirements of the classification for which the RAP is entered (i.e. 10% Class III with 20% Class I, blend must meet Class I criteria). The Department may take belt cuts of the blended RAP to verify the material meets these requirements. If the Contractor elects to use more than one RAP source in a design, the Contractor shall provide an acceptable point of sampling blended RAP material from the feed belt.

In the event that RAP source or properties change, the Contractor shall notify the Department of the change and submit new documentation stating the new source or properties a minimum of 72 hours prior to the change to allow for obtaining new samples and approval.

SECTION 710

FENCE AND GUARDRAIL

710.06 Fence Posts and Braces Revise the first Paragraph so that it reads:

“Wood posts shall be of cedar, white oak, or tamarack or other AWPAs approved species, of the diameter or section and length shown on the plans.”

Remove the fourth paragraph which starts “ That portion of wood posts...”.

Revise the paragraph beginning with “Braces shall be of spruce, eastern hemlock ... so that it now reads:

“Braces shall be of spruce, eastern hemlock, Norway pine, pitch pine, or tamarack timbers or other AWPAs approved species, or spruce, cedar, tamarack or other AWPAs approved species round posts of sufficient length to make a diagonal brace between adjacent posts. All wood posts and braces shall be pressure-treated in accordance with AASHTO M 133 and AWPAs U1, UC4A Commodity Specification B: Posts. “

710.07 Guardrail Posts Revise this section so that the first sentence of section a. reads:

“a. Wood posts shall be of Norway pine, southern yellow pine, pitch pine, Douglas fir, red pine, white pine, or eastern hemlock or other AWPAs approved species.”

Revise the next paragraph so that it reads:

Wood posts and offset brackets shall be preservative treated in accordance with the requirements of AASHTO M 133 and AWPAs U1, UC4A Commodity Specification B: Posts.

SECTION 712 MISCELLANEOUS HIGHWAY MATERIAL

712.061 Structural Precast Units Amend this section by adding the following sentence to the end of the first paragraph of the Construction subsection:

“Facilities certified by NPCA or PCI shall provide to the Fabrication Engineer a copy of their annual audit to include deficiency reports and corrective actions.”

Revise this section by changing the letter “b” of ASTM C1611 of the Concrete Testing subsection so that it reads:

“b. Air content shall be 5.0% to 8.0%.”

SECTION 718
TRAFFIC SIGNALS MATERIAL

718.03 Signal Mounting Amend the paragraph beginning with “All trunions, brackets and...” by adding “**For polycarbonate signal heads with more than 3 sections or requiring mounting extensions greater than 12 inches in length, reinforcing plates shall be used to reinforce the housings at the point of attachment.**” to the end of the paragraph.

718.08 Controller Cabinet Revise this subsection by replacing the paragraph beginning with “The cabinet shall be supplied with LED light panels...” on or about page 7-66 with “**The cabinet shall be supplied with white LED light panels which shall automatically illuminate via a door open switch whenever one of the four main cabinet doors are opened for the ground mount cabinet or two main doors for the side of pole cabinet. The ground mounted cabinet shall contain four LED light panels per side totaling eight panels for the cabinet; one panel each at the top and bottom portion of the front side and back side on the Control side and Power/Auxiliary side of the cabinet. Each light panel shall produce a minimum of 250 lumens for a total minimum lumen output of 2000 lumens with all eight panels illuminated. The minimum output per side would be 1000 lumens. The LED panels shall be protected by a clear shatterproof shield. The side of pole mounted cabinet shall contain four light panels; one at the top of the rack assembly and one at the bottom rack assembly on each side of the cabinet. A second door open status switch per door shall activate a controller input to log a report event that one of the doors was opened. All door open status switches shall be connected to the same controller input. For the ground mount cabinet, there shall be two switches on each of the four main doors. For the side-of-pole mount cabinet, there shall be two switches on each of the two main doors.**”

Revise this subsection by replacing the paragraph beginning with “The cabinet shall be supplied with a generator panel ...” on or about page 7-68 with:

“The cabinet shall be supplied with a generator panel. The generator panel shall consist of a manual transfer switch and a twist-lock connector for generator hookup. The transfer switch knob and twist-lock connector shall be located inside a stainless steel enclosure with a separate lockable door accessed with a Corbin #2 key. The unit shall be mounted on the left, exterior of the control side wall of the ground mount cabinet a minimum of 36” above the surrounding grade and on the lower left side of the pole mounted cabinet. The generator transfer switch shall be a Reliance C30A1N Signa Series or approved equal. “

Revise this subsection by removing the following from the paragraph beginning with “The ground mounted cabinet shall be supplied and installed with an electric service meter socket trim and electrical service disconnect switch ...” on or about page 7-69: “**(removed: thus preventing that space from being used either by equipment supplied as part of the project, or future equipment that would be installed in the rack system. Joe indicated that he would add this language to the detail so it is covered.)**”.

Revise this subsection by replacing the following in the paragraph beginning with “The Contractor shall reconfigure the default user name...” on or around page 7-70; “MaineDOT IT” with “**MaineDOT Traffic Division**”.

In the paragraph beginning with “Tests shall be conducted by the contractor...” on or around page 7-73, amend this subsection by removing “**in the state of Maine and**” after “The facility shall be”.

Amend this Section by adding the following subsection:

718.13 Field Monitoring Unit (FMU) This item of work shall conform to this specification. This item shall consist of furnishing and installing a Field Monitoring Unit (FMU) and software, as well as all needed accessories required for a full and complete installation, including but not limited to power adapters, Ethernet cables, and interface cables, as described herein.

Where applicable, communications from MaineDOT’s cloud-based Central Management System (CMS) to the on-street traffic signal controllers shall be made through fiber optic interconnect cable connected back to existing internet connections and/or the Field Monitoring Unit (FMU). The Contractor shall furnish and install all materials necessary for a complete and operational fiber optic interconnection to all project intersections as shown on the plans. All connections to the CMS cloud-based system shall be via a secure VPN network.

The FMU shall be the only remote connection device used by isolated intersections to connect to the cloud-based system. All connections shall be encrypted VPN tunnels. The Contractor shall coordinate all configuration settings with MaineDOT IT and the Engineer.

The FMU central web based interface shall be a separate element from the CMS.

MATERIALS: The materials for this work shall conform to the following requirements:

1. The work under this item specifies the requirements for the FMU. The FMU shall operate independent of the brand/type of intersection controller deployed in the ATC traffic cabinet.
2. The FMU shall conform to the following requirements:
 - 2.1 The FMU shall function correctly between -34 degrees C and +74 degrees C.
 - 2.2 The FMU shall be provided with appropriately rated connectors that allows the FMU to be exchanged by unplugging connectors, without tools.
 - 2.3 The FMU shall monitor and log all ATC Controller and ATC cabinet faults and or alarms.
 - 2.4 The FMU shall be wired directly to the ATC cabinet.
 - 2.5 The FMU shall have an internal cellular modem running at 4G LTE.
 - 2.5.1 The Cellular modem shall be designed to be replaced / upgraded to 5G service when available.

- 2.6 The FMU shall incorporate an integrated GPS and cell modem.
- 2.7 The configuration of the FMU shall be accomplished by accessing the internal web server with a browser. It shall be possible to configure the FMU without any special software.
- 2.8 The FMU shall be powered via a standard 120V input power.
- 2.9 The FMU shall allow for the routing of the controller configuration packets to and from the controller (either by Ethernet or serial communications) for any type of controller utilized by the MaineDOT. In this way it shall be possible to configure the controller and utilize the controller specific software to interrogate the controller, and the FMU shall provide the communications pipe which allows this to be accomplished.
- 2.10 The FMU shall, within the size limitations above, include a battery and battery charging/monitoring circuit, to allow the FMU to function correctly even when all power to the intersection has failed. The battery shall continue to power the FMU for a minimum of 5 hours after all power has failed to the intersection.
- 2.11 The FMU shall incorporate an integrated GPS which will allow the FMU to geo-locate itself on the FMU management software map, without configuration.
- 2.12 The FMU shall operate without requiring a static IP address. The only configuration required at the FMU is to enter the URL of where the FMU management software is hosted.
- 2.13 In the event that the cell service is interrupted or is not available, the FMU shall store any events that occur in internal memory and forward these events automatically to the FMU management software when the cell service is restored. In this way, a complete record of events at the device can be maintained even if cell service is interrupted for a period. The system will store 5000 events.
- 2.14 The FMU shall utilize HTTP and HTTPS protocols, and XML data structures, for communication with the FMU management software. In this way the data will be open for future expansion and competition. The use of secret proprietary protocols is not permitted.
- 2.15 The FMU shall include Ethernet communications via an Ethernet Port with RJ45 connector.
- 2.16 The FMU shall include weather proof antennas.

3. **Map Display FMU Management Software**

- 3.1 The FMU shall include a scrollable, zoomable map display, with the intersections and other monitored devices shown as representative icons on the map. The map shall include the ability to see the intersections using Google Streetview.

- 3.2 The alarm status of the intersection shall be clearly indicated on the icon on the map, so that the user can see at a glance which intersections are in alarm.
- 3.3 The map display shall also include a list of intersections, with the number and priority of alarms indicated on the list. Intersections in high priority alarm shall be moved to the top of the list, followed by medium priority, low priority and then finally by intersections not in alarm.
- 3.4 The icons shall change to be able to clearly indicate if an intersection is offline.
- 3.5 Clicking on the icon on the map shall expose a box with the current parameters of the intersection shown.
- 3.6 The default map display position and zoom shall be configurable by user, so that the user's view will default to show the intersections that the user is responsible for managing.
- 3.7 The map view shall have the ability to show Google traffic overlays on the map.

4. Intersection Detail Display FMU Management Software

- 4.1 It shall be possible to drill down, either from the map icon or from the list, to a device level detail for the intersection, which as a minimum shall display the following parameters:
 - 4.1.1 The alarm status, with priority indicated, and a text description of the alarm (if an alarm is present for this device).
 - 4.1.2 The time since the last communication with the device
 - 4.1.3 The following parameters (real time now values, minimum for the day values, maximum for the day values, and average for the day values)
 - 4.1.3.1 The AC mains voltage (value)
 - 4.1.3.2 The battery back-up voltage (value)
 - 4.1.3.3 The cabinet temperature (value)
 - 4.1.3.4 The cabinet humidity (value)
 - 4.1.3.5 The presence of AC power (OK or Fail)
 - 4.1.3.6 The flashing status of the intersection (OK or Flashing)
 - 4.1.3.7 Stop Time status (OK or Stop Time Active)
 - 4.1.3.8 The cabinet door status (Open or Closed)
 - 4.1.3.9 The intersection fan status (Fan On or Fan off)

4.1.4 It shall be possible to view graphs of each of the value parameters in graphical form, over the recent two-week period. This includes real time graphs of:

4.1.4.1 The AC mains voltage

4.1.4.2 The battery back-up voltage

4.1.4.3 The cabinet temperature

4.1.4.4 The cabinet humidity

5. Diagnostics and Log Display FMU Management Software

5.1 From the device level detail within the FMU management software, it shall be possible to drill down to get the raw data; the error logs; and the communications logs to allow a technician to fault-find problems.

5.2 It shall be possible to filter the logs by Device; by Device Type and/or by Group as well as between dates.

5.3 It shall be possible to print these selected logs to a local printer or a PDF file.

5.4 It shall be possible to export these logs to Excel on the local computer for further analysis.

6. Alarms FMU Management Software

6.1 The FMU management software shall have a comprehensive alarm generation capability

6.2 It shall be possible to configure alarms to be generated on any parameter becoming out of tolerance, including analog values, digital values and enumerated values.

6.3 Alarms shall be configurable to be of Low, High or Critical Priority.

6.4 The alarm priority shall be displayed throughout the FMU management software, on all displays, using color codes such as red-critical; yellow – high; and amber-low to indicate the priority of the alarm.

6.5 The current active alarms shall be accessible for view via an expandable window, to see which alarms are active and when the alarm occurred. The highest priority alarms shall rise to the top of the list.

7. Alerts FMU Management Software

7.1 The FMU management software shall have comprehensive alerting capability, to enable the response personnel to be notified when an abnormal situation has occurred.

7.2 It shall be possible to configure alerts to one or more personnel for each alarm. This will cause, as selected, an SMS and/or an email to be sent to the person when an alarm occurs.

7.3 The alert shall be configurable to optionally send via email and/or via SMS a message when an alarm clears.

7.4 The intention is that the FMU management software provides the alerts to the user in near real time. The SMS and email shall be issued within 30 seconds of the occurrence of event which results in an alert being issued.

8. **Hosting and Connectivity and Service FMU / FMU Management Software**

8.1 The contractor shall supply the FMU with the FMU manufacturers 10 year options for Connectivity and Service, as part of the purchase price. The Connectivity and Service agreement shall include at a minimum:

8.1.1 Cellular Connectivity

8.1.2 No cellular overage charges

8.1.3 Extended warranty on the hardware for the period of the Connectivity and Service Agreement

8.1.4 Over-the-air software updates

8.1.5 Over-the-air security updates

8.1.6 Future Connected Vehicles Service

SECTION 720

STRUCTURAL SUPPORTS FOR HIGHWAY SIGNS, LUMINAIRES AND TRAFFIC SIGNALS

720.12 Wood Sign Posts Revise the first sentence so that it reads:

Wood sign posts shall be rectangular, straight and sound timber, cut from live growing native spruce, red pine, hemlock, cedar trees or other AWPAs approved species, free from loose knots or other structurally weakening defects of importance, such as shake or holes or heart rot.

Revise the third paragraph that starts with “When pressure treated...” so that it reads:

All sign posts shall be pressure-treated in accordance with AASHTO M 133 and AWPAs Standard U1, UC4A, Commodity Specification A: Sawn Products.

APPENDIX A TO DIVISION 100

SECTION 1 - BIDDING PROVISIONS

A. Federally Required Certifications By signing and delivering a Bid, the Bidder certifies as provided in all certifications set forth in this Appendix A - Federal Contract Provisions Supplement including:

- Certification Regarding No Kickbacks to Procure Contract as provided on this page 1 below.
- Certification Regarding Non-collusion as provided on page 1 below.
- Certification Regarding Non-segregated Facilities as provided by FHWA Form 1273, section III set forth on page 21 below.
- "Certification Regarding Debarment, Suspension, Ineligibility and Voluntary Exclusion" as provided by FHWA Form 1273, section XI set forth on page 32 below.
- "Certification Regarding Use of Contract Funds for Lobbying" as provided by FHWA Form 1273, section XII set forth on page 35 below.

Unless otherwise provided below, the term "Bidder", for the purposes of these certifications, includes the Bidder, its principals, and the person(s) signing the Bid. Upon execution of the Contract, the Bidder (then called the Contractor) will again make all the certifications indicated in this paragraph above.

CERTIFICATION REGARDING NO KICKBACKS TO PROCURE CONTRACT Except expressly stated by the Bidder on sheets submitted with the Bid (if any), the Bidder hereby certifies, to the best of its knowledge and belief, that it has not:

(A) employed or retained for a commission, percentage, brokerage, contingent fee, or other consideration, any firm or person (other than a bona fide employee working solely for me) to solicit or secure this contract;

(B) agreed, as an express or implied condition for obtaining this contract, to employ or retain the services of any firm or person in connection with carrying out the contract, or;

(C) paid, or agreed to pay, to any firm, organization, or person (other than a bona fide employee working solely for me) any fee, contribution, donation, or consideration of any kind for, or in connection with, procuring or carrying out the contract;

By signing and submitting a Bid, the Bidder acknowledges that this certification is to be furnished to the Maine Department of Transportation and the Federal Highway Administration, U.S. Department of Transportation in connection with this contract in anticipation of federal aid highway funds and is subject to applicable state and federal laws, both criminal and civil.

CERTIFICATION REGARDING NONCOLLUSION Under penalty of perjury as provided by federal law (28 U.S.C. §1746), the Bidder hereby certifies, to the best of its knowledge and belief, that:

the Bidder has not, either directly or indirectly, entered into any agreement, participated in any collusion, or otherwise taken any action in restraint of competitive bidding in connection with the Contract.

For a related provisions, see Section 102.7.2 (C) of the Standard Specifications - "Effects of Signing and Delivery of Bids" - "Certifications", Section 3 of this Appendix A entitled "Other Federal Requirements" including section XI - "Certification Regarding Debarment, Suspension, Ineligibility, and Voluntary Exclusion" and section XII. - "Certification Regarding Use of Contract Funds for Lobbying."

B. Bid Rigging Hotline To report bid rigging activities call: **1-800-424-9071**

The U.S. Department of Transportation (DOT) operates the above toll-free "hotline" Monday through Friday, 8:00 a.m. to 5:00 p.m., eastern time. Anyone with knowledge of possible bid rigging, bidder collusion, or other fraudulent activities should use the "hotline" to report such activities.

The "hotline" is part of the DOT's continuing effort to identify and investigate highway construction contract fraud and abuse and is operated under the direction of the DOT Inspector General. All information will be treated confidentially and caller anonymity will be respected.

SECTION 2 - FEDERAL EEO AND CIVIL RIGHTS REQUIREMENTS

Unless expressly otherwise provided in the Bid Documents, the provisions contained in this Section 2 of this "Federal Contract Provisions Supplement" are hereby incorporated into the Bid Documents and Contract.

A. Nondiscrimination & Civil Rights - Title VI The Contractor and its subcontractors shall not discriminate on the basis of race, color, national origin, or sex in the performance of this Contract. The Contractor shall carry out applicable requirements of 49 CFR Part 26 in the award and administration of DOT assisted contracts. Failure by the Contractor to carry out these requirements is a material breach of this contract, which may result in the termination of this contract or such other remedy as the Department deems appropriate. The Contractor and subcontractors shall comply with Title VI of the Civil Rights Act of 1964, as amended, and with all State of Maine and other Federal Civil Rights laws.

For related provisions, see Subsection B - "Nondiscrimination and Affirmative Action - Executive Order 11246" of this Section 2 and Section 3 - Other Federal Requirements of this "Federal Contract Provisions Supplement" including section II - "Nondiscrimination" of the "Required Contract Provisions, Federal Aid Construction Contracts", FHWA-1273.

B. Nondiscrimination and Affirmative Action - Executive Order 11246 Pursuant to Executive Order 11246, which was issued by President Johnson in 1965 and amended in 1967 and 1978, this Contract provides as follows.

The Contractor shall take specific affirmative actions to ensure equal employment opportunity. The evaluation of the Contractor's compliance with these specifications shall be based upon its efforts to achieve maximum results from its actions. The Contractor shall document these efforts fully, and shall implement affirmative action steps at least as extensive as the following:

Ensure and maintain a working environment free of harassment, intimidations, and coercion at all sites, and in all facilities at which the Contractor's employees are assigned to work. The Contractor, where possible, will assign two or more women to each construction project. The Contractor shall specifically ensure that all forepersons, superintendents, and other on-site supervisory personnel are aware of and carry out the Contractor's obligation to maintain such a working environment, with specific attention to minority or female individuals working at such sites or in such facilities.

Establish and maintain a current list of minority and female recruitment sources, provide written notification to minority and female recruitment sources and to community organizations when the Contractor or its union have employment opportunities available, and to maintain a record of the organization's responses.

Maintain a current file of the names, addresses and telephone numbers of each minority and female off-the-street applicant and minority or female referral from a union, a recruitment source or community organization and of what action was taken with respect to each such individual. If such individual was sent to the union hiring hall for referral and was not referred back to the Contractor by the union or, if referred, not employed by the Contractor, this shall be documented in the file with the reason therefore, along with whatever additional actions the Contractor may have taken.

Provide immediate written notification to the Department's Civil Rights Office when the union or unions with which the Contractor has a collective bargaining agreement has not referred to the Contractor a minority person or woman sent by the Contractor, or when the Contractor has other information that the union referral process has impeded the Design-Builder's efforts to meet its obligations.

Develop on-the-job training opportunities and/or participate in training programs for the area which expressly include minorities and women, including upgrading programs and apprenticeship and trainee programs relevant to the Contractor's employment needs, especially those programs funded or approved by the Department of Labor. The Contractor shall provide notice of these programs to the sources compiled under B above.

Disseminate the Contractor's EEO policy by providing notice of the policy to unions and training programs and requesting their cooperation in assisting the Contractor in meeting its EEO obligation; by including it in any policy manual and collective bargaining agreement; by publicizing it in the company newspaper, annual report, etc.; by specific review of the policy with all management personnel and with all minority and female employees at least once a year; and by posting the company EEO policy on bulletin boards accessible to all employees at each location where construction work is performed.

Review, at least annually, the company's EEO policy and affirmative action obligations under these specifications with all employees having any responsibility for hiring, assignment, layoff, termination, or other employment decisions including specific review of these items with on-site supervisory personnel such as Superintendents, General Forepersons, etc., prior to the initiation of construction work at any job site. A written record shall be made and maintained identifying the time and place of these meetings, persons attending, subject matter discussed, and disposition of the subject matter.

Disseminate the Contractor's EEO policy externally by including it in any advertising in the news media, specifically including minority and female news media, and providing written notification to and discussing the Contractor's EEO policy with other Contractor's and Subcontractors with whom the Contractor does or anticipates doing business.

Direct its recruitment efforts, both orally and written to minority, female and community organizations, to schools with minority and female students and to minority and female recruitment and training organizations serving the Contractor's recruitment area and employment needs. Not later than one month prior to the date for the acceptance of applications for apprenticeship or other training by any recruitment source, the Contractor shall send written notification to organizations such as the above describing the openings, screenings, procedures, and test to be used in the selection process.

Encourage present minority and female employees to recruit other minority persons and women and, where reasonable, provide after school, summer and vacation employment to minority and female youth, both on the site and in other areas of a Contractor's workforce.

Validate all tests and other selection requirements.

Conduct, at least annually, an inventory and evaluation at least of all minority and female personnel for promotional opportunities and encourage these employees to seek or to prepare for, through appropriate training, etc., such opportunities.

Ensure that seniority practices, job classifications, work assignments and other personnel practices, do not have a discriminatory effect by continually monitoring all personnel and employment related activities to ensure that the EEO policy and the Contractor's obligations under these specifications are being carried out.

Ensure that all facilities and company activities are non segregated except that separate or single-user toilet and necessary changing facilities shall be provided to assure privacy between the sexes.

Document and maintain a record of all solicitations of offers for subcontracts from minority and female construction Contractor's and suppliers, including circulation of solicitations to minority and female Contractor associations and other business associations.

Conduct a review, at least annually, of all supervisors' adherence to and performance under the Contractor's EEO policies and affirmative action obligations.

C. Goals for Employment of Women and Minorities Per Executive Order 11246, craft tradesperson goals are 6.9% women and .5% minorities employed. However, goals may be adjusted upward at the mutual agreement of the Contractor and the Department. Calculation of these percentages shall not include On-the-Job Training Program trainees, and shall not include clerical or field clerk position employees.

For a more complete presentation of requirements for such Goals, see the federally required document "Goals for Employment of Females and Minorities" set forth in the next 6 pages below.

Start of GOALS FOR EMPLOYMENT OF FEMALES AND MINORITIES
Federally Required Contract Document

§60-4.2 Solicitations

(d) The following notice shall be included in, and shall be part of, all solicitations for offers and bids on all Federal and federally assisted construction contracts or subcontracts in excess of \$10,000 to be performed in geographical areas designated by the Director pursuant to §60-4.6 of this part (see 41 CFR 60-4.2(a)):

Notice of Requirement for Affirmative Action to Ensure Equal Opportunity (Executive Order 11246)

1. The Offeror's or bidder's attention is called to the "Equal Opportunity Clause" and the "Standard Federal Equal Employment Specifications" set forth herein.
2. The goals and timetables for minority and female participation, expressed in percentage terms for the Contractor's aggregate work force in each trade on all construction work in the covered area, are as follows:

<u>Goals for female participation in each trade</u>	6.9%
---	------

Goals for minority participation for each trade

Maine

001 Bangor, ME	0.8%
----------------	------

Non-SMSA Counties (Aroostook, Hancock, Penobscot, Piscataquis, Waldo, Washington)

002 Portland-Lewiston, ME

SMSA Counties: 4243 Lewiston-Auburn, ME	0.5%
---	------

(Androscoggin)

6403 Portland, ME	0.6%
-------------------	------

(Cumberland, Sagadahoc)

Non-SMSA Counties:
(Franklin, Kennebec, Knox, Lincoln, Oxford, Somerset, York)

These goals are applicable to all the Contractor's construction work (whether or not it is Federal or federally assisted) performed in the covered area. If the contractor performs construction work in a geographical area located outside of the covered area, it shall apply the goals established for such geographical area where the work is actually performed. With regard to this second area, the contractor also is subject to the goals for both its federally involved and non federally involved construction.

The contractor's compliance with the Executive Order and the regulations in 41 CFR Part 60-4 shall be based on its implementation of the Equal Opportunity Clause, specific affirmative action obligations required by the specifications set forth in 41 CFR 60-4.3(a), and its efforts to meet the goals. The hours of minority and female employment and training must be substantially uniform throughout the length of the contract, and in each trade, and the contractor shall make a good faith effort to employ minorities and women evenly on each of its projects. The transfer of minority or female employees or trainees from Contractor to Contractor or from project to project for the sole purpose of meeting the Contractor's goals shall be in violation of the contract, the Executive Order and the regulations in 41 CFR Part 60-4. Compliance with the goals will be measured against the total work hours performed.

3. The Contractor shall provide written notification to the Director of the Office of Federal Contract Compliance Programs within 10 working days of award of any construction subcontract in excess of \$10,000 at any tier for construction work under the contract resulting from this solicitation. The notification shall list the name, address and telephone number of the subcontractor, employer identification number of the subcontractor, estimated dollar amount of the subcontract; estimated started and completion dates of the subcontract; and the geographical area in which the subcontract is to be performed.

4. As used in this Notice, and in the Contract resulting from this solicitation, the "covered area" is (insert description of the geographical areas where the contract is to be performed giving the state, county and city, if any).

STANDARD FEDERAL EQUAL EMPLOYMENT OPPORTUNITY CONSTRUCTION
CONTRACT SPECIFICATIONS (EXECUTIVE ORDER 11246)

1. As used in these specifications:
 - a. "Covered area" means the geographical area described in the solicitation from which this contract resulted;
 - b. "Director" means Director, Office of Federal Contract Compliance Programs, United States Department of Labor, or any person to whom the Director delegates authority;
 - c. "Employer identification number" means the Federal Social Security number used on the Employer's Quarterly Federal Tax Return, U.S. Treasury Department form 941;
 - d. "Minority" includes:

- (i) Black (all persons having origins in any of the Black African racial groups not of Hispanic origin);
 - (ii) Hispanic (all persons of Mexican, Puerto Rican, Cuban, Central or South American or other Spanish Culture or origin, regardless of race);
 - (iii) Asian and Pacific Islander (all persons having origins in any of the original peoples of the Far East, Southeast Asia, the Indian Subcontinent, or the Pacific Islands); and
 - (iv) American Indian or Alaskan Native (all persons having origins in any of the original peoples of the North America and maintaining identifiable tribal affiliations through membership and participation or community identification).
2. Whenever the Contractor, or any subcontractor at any tier, subcontracts a portion of the work involving any construction trade, it shall physically include in each subcontract in excess of \$10,000 the provisions of these specifications and the Notice which contains the applicable goals for minority and female participation and which is set forth in the solicitations from which this contract resulted.
3. If the contractor, is participating (pursuant to 41 CFR 60-4.5) in a Hometown Plan approved by the U.S. Department of Labor in the covered area either individually or through an association, its affirmative action obligations on all work in the Plan area (including goals and timetables) shall be in accordance with that Plan for those trades which have unions participating in the Plan. Contractors must be able to demonstrate their participation in and compliance with the provisions of any such Hometown Plan. Each Contractor or Subcontractor participating in an approved Plan is individually required to comply with its obligations under the EEO clause, and to make a good faith effort to achieve each goal under the Plan in each trade in which it has employees. The overall good faith performance by other Contractors for Subcontractors toward a goal in an approved Plan does not excuse any covered Contractor's or Subcontractor's failure to take good faith efforts to achieve the Plan goals and timetables.
4. The Contractor shall implement the specific affirmative action standards provided in paragraphs 7 a. through p. of these specifications. The goals set forth in the solicitation from which this contract resulted are expressed as percentages of the total hours of employment and training of minority and female utilization the Contractor should reasonably be able to achieve in each construction trade in which it has employees in contractors performing construction work in geographical areas where they do not have a Federal or federally assisted construction contract shall apply the minority and female goals established for the geographical areas where the work is being performed. Goals are published periodically in the Federal Register in notice form and such notices may be obtained from any Office of Federal Contract Compliance Programs office or from Federal procurement contracting officers. The Contractor is expected to make substantially uniform progress in meeting its goals in each craft during the period specific.
5. Neither the provisions of any collective bargaining agreement, nor the failure by a union with whom the Contractor has a collective bargaining agreement, to refer either minorities or women shall excuse the Contractor's obligations under these specifications, Executive Order 11246, or the regulations promulgated pursuant, thereto.

6. In order for the non working training hours of apprentices and trainees to be counted in meeting the goals, such apprentices and trainees must be employed by the Contractor during the training period, and the Contractor must have made a commitment to employ the apprentices and trainees at the completion of their training, subject to the availability of employment opportunities. Trainees must be trained pursuant to training programs approved by the U.S. Department of Labor.
7. The Contractor shall take specific affirmative actions to ensure equal employment opportunity. The evaluation of the Contractor's compliance with these specifications shall be based upon its effort to achieve maximum results from its actions. The Contractor shall document these efforts fully, and shall implement affirmative action steps at least as expensive as the following:
 - a. Ensure and maintain a working environment free of harassment, intimidation, coercion at all sites, and in all facilities at which the Contractor's employees are assigned to work. The Contractor, when possible, will assign two or more women to each construction project. The Contractor shall specifically ensure that all foremen, superintendents, and other on-site supervisory personnel are aware of and carry out the Contractor's obligation to maintain such a working environment, with specific attention to minority or female individuals working at such sites or in such facilities.
 - b. Establish and maintain a current list of minority and female recruitment sources provide written notification to minority and female recruitment sources and to community organizations when the Contractor or its unions have employment opportunities available, and maintain a record of the organization's responses.
 - c. Maintain a current file of the names, addresses and telephone numbers of each minority and female off-the-street applicant and minority or female referral from a union, a recruitment sources or community organization and of what action was taken with respect to each such individual. If such individual was sent to the union hiring hall for referral and was not referred back to the Contractor by the union or, if referred, not employed by the Contractor, this shall be documented in the file with the reason therefore, along with whatever additional actions the Contractor may have taken.
 - d. Provide immediate written notification to the Director when the union or unions with which the Contractor has a collective bargaining agreement has not referred to the Contractor a minority person or woman sent by the Contractor, or when the Contractor has other information that the union referral process has impeded the Contractor's efforts to meet its obligations.
 - e. Develop on-the-job training opportunities and/or participate in training programs for the area which expressly include minorities and women, including upgrading programs and apprenticeship and trainee programs relevant to the Contractor's employment needs, especially those programs funded or approved by the Department of Labor. The Contractor shall provide notice of these programs to the sources complied under 7b above.

- f. Disseminate the Contractor's EEO policy by providing notice of the policy to unions and training programs and requesting their cooperation in assisting the Contractor in meeting its EEO obligations; by including in any policy manual and collective bargaining agreement; by publicizing it in the company newspaper, annual report, etc.; by specific review of the policy with all management personnel and with all minority and female employees at least once a year; and by posting the company EEO policy on bulletin boards accessible to all employees at each location where construction work is performed.
- g. Review, at least annually, the company's EEO policy and affirmative action obligations under these specifications with all employees having any responsibility for hiring, assignment, layoff, termination or other employment decisions including specific review of these items with on-site supervisory personnel such as Superintendents, General Foremen, etc., prior to the initiation of construction work at any job site. A written record shall be made and maintained identifying the time and place of these meetings, persons attending, subject matter discussed, and disposition of the subject matter.
- h. Disseminate the Contractor's EEO policy externally by including it in any advertising in the news media, specifically including minority and female news media, and providing written notification to and discussing the Contractor's EEO policy with other Contractors and Subcontractors with whom the Contractor does or anticipates doing business.
- i. Direct its recruitment, efforts, both oral and written, to minority, female and community organizations, to schools with minority and female students and to minority and female recruitment and training organizations serving the Contractor's recruitment area and employment needs. Not later than one month other training by any recruitment source, the Contractor shall send written notification to organizations such as the above, describing prior to the date for the acceptance of applications for apprenticeship or the openings, screening procedures, and tests to be used in the selection process.
- j. Encourage present minority and female employees to recruit other minority persons and women and, where reasonable, provide after school, summer and vacation employment to minority and female youth both on site and in other areas of a Contractor's work force.
- k. Validate all tests and other selection requirements where there is an obligation to do so under 41 CFR Part 60-3.
- l. Conduct, at least annually, an inventory and evaluation at least of all minority and female personnel for promotional opportunities and encourage these employees to seek or to prepare for, through appropriate training, etc., such opportunities.
- m. Ensure that seniority practices, job classifications, work assignments and other personnel practices, do not have a discriminatory effect by continually monitoring all personnel and employment related activities to ensure that the EEO policy and the Contractor's obligations under these specifications are being carried out.

- n. Ensure that all facilities and company activities are non segregated except that separate or single-user toilet and necessary changing facilities shall be provided to assure privacy between the sexes.
 - o. Document and maintain a record of all solicitations of offers for subcontracts from minority and female construction contractors and suppliers, including circulation of solicitation to minority and female contractor associations and other business associations.
 - p. Conduct a review, at least annually, of all supervisor's adherence to and performance under the Contractor's EEO policies and affirmative action obligations.
8. Contractors are encouraged to participate in voluntary associations which assist in fulfilling one or more of their affirmative action obligations (7 a through p.). The efforts of a contractor association, joint contractor-union, contractor-community, or other similar group of which the contractor is a member and participant, may be asserted as fulfilling any one or more of its obligations under 7 a through p. of these specifications provided that the contractor actively participates in the group, makes every effort to assure that the group has a positive impact on the employment of minorities and women in the industry, ensures that the concrete benefits of the program and reflected in the Contractor's minority and female work force participation, makes a good faith effort to meet its individual goals and timetables, and can provide access to documentation which demonstrates the effectiveness of actions take on behalf of the Contractor. The obligation to comply, however, is the Contractor's and failure of such a group to fulfill an obligation shall not be a defense for the Contractor's noncompliance.
9. A single goal for minorities and a separate single goal for women have been established. The Contractor, however, is required to provide equal employment opportunity and to take affirmative action for all minority groups, both male and female, and all women, both minority and non-minority. Consequently, the Contractor may be in violation of the Executive Order if a particular group is employed in a substantially disparate manner (for example, specific minority group of women is underutilized.)
10. The Contractor shall not use the goals and timetables or affirmative action even through the Contractor has achieved its goals for women generally, the Contractor may be in violation of the Executive Order if standards to discriminate against any person because of race, color, religion, sex, or national origin.
11. The Contractor shall not enter into any Subcontract with any person or firm debarred from Government contracts pursuant to Executive Order 11246.
12. The Contractor shall carry out such sanctions and penalties for violation of these specifications and of the Equal Opportunity Clause, including suspension, termination and cancellation of existing subcontracts as may be imposed or ordered pursuant to Executive Order 11246, as amended, and its implementation regulations by the Office of Federal Contract Compliance Programs. Any Contractor who fails to carry out such sanctions and penalties shall be in violation of these specifications and Executive Order 11246, as amended.

- 13. The Contractor, in fulfilling its obligations under these specifications, shall implement specific affirmative action steps, at least as extensive as those standards prescribed in paragraph 7 of these specifications, so as to achieve maximum results from its efforts to ensure equal employment opportunity. If the Contractor fails to comply with the requirements of the Executive Order, the implementing regulations, or these specifications, the Director shall proceed in accordance with 41 CFR 60-4.6.
- 14. The Contractor shall designate a responsible official to monitor all employment related activity to ensure that the company EEO policy is being carried out, to submit reports relating to the provisions hereof as may be required by the Government and to keep records. Records shall at least include for each employee the name, address, telephone numbers, construction trade, union affiliation if any, employee identification number when assigned, social security number, race, sex, status (e.g. mechanic, apprentice, trainee, helper, or laborer), dates of changes in status, hours worked per week in the indicated trade, rate of pay, and location at which the work was performed. Records be maintained in an easily understandable and retrievable form; however, to the degree that existing records satisfy this requirement, contractors shall not be required to maintain separate records.
- 15. Nothing herein provided shall be construed as a limitation upon the application of other laws which establish different standards of compliance or upon the application of requirements for the hiring of local or other area residents (e.g., those under the Public Works Employment Act of 1977 and the Community Development Block Grant Program).

End of GOALS FOR EMPLOYMENT OF FEMALES AND MINORITIES
Federally Required Contract Document

D. Section '**D Disadvantaged Business Enterprise (DBE) Requirements**' is removed in its entirety. The DBE material is in:

Section 105.10 EQUAL OPPORTUNITY AND CIVIL RIGHTS.

SECTION 3 - OTHER FEDERAL REQUIREMENTS

Unless expressly otherwise provided in the Bid Documents, the provisions contained in this Section 3 of this "Federal Contract Provisions Supplement" are hereby incorporated into the Bid Documents and Contract.

A. Buy America

If the cost of products purchased for permanent use in this project which are manufactured of steel, iron or the application of any coating to products of these materials exceeds 0.1 percent of the contract amount, or \$2,500.00, whichever is greater, the products shall have been manufactured and the coating applied in the United States. The coating materials are not subject to this clause, only the application of the coating. In computing that amount, only the cost of the product and coating application cost will be included.

Ore, for the manufacture of steel or iron, may be from outside the United States; however, all other manufacturing processes of steel or iron must be in the United States to qualify as having been manufactured in the United States.

United States includes the 50 United States and any place subject to the jurisdiction thereof.

Products of steel include, but are not limited to, such products as structural steel, piles, guardrail, steel culverts, reinforcing steel, structural plate and steel supports for signs, luminaries and signals.

Products of iron include, but are not limited to, such products as cast iron grates.

Application of coatings include, but are not limited to, such applications as epoxy, galvanized and paint.

To assure compliance with this section, the Contractor shall submit a certification letter on its letterhead to the Department stating the following:

“This is to certify that products made of steel, iron or the application of any coating to products of these materials whose costs are in excess of \$2,500.00 or 0.1 percent of the original contract amount, whichever is greater, were manufactured and the coating, if one was required, was applied in the United States.”

B. Materials

a. Convict Produced Materials References: 23 U.S.C. 114(b)(2), 23 CFR 635.417

Applicability: FHWA's prohibition against the use of convict material only applies to Federal-aid highways. Materials produced after July 1, 1991, by convict labor may only be incorporated in a Federal-aid highway construction project if: 1) such materials have been produced by convicts who are on parole, supervised release, or probation from a prison; or 2) such material has been produced in a qualified prison facility, e.g., prison industry, with the amount produced during any 12-month period, for use in Federal-aid projects, not exceeding the amount produced, for such use, during the 12-month period ending July 1, 1987.

Materials obtained from prison facilities (e.g., prison industries) are subject to the same requirements for Federal-aid participation that are imposed upon materials acquired from other sources. Materials manufactured or produced by convict labor will be given no preferential treatment.

The preferred method of obtaining materials for a project is through normal contracting procedures which require the contractor to furnish all materials to be incorporated in the work. The contractor selects the source, public or private, from which the materials are to be obtained (23 CFR 635.407). Prison industries are prohibited from bidding on projects directly (23 CFR 635.112e), but may act as material supplier to construction contractors.

Prison materials may also be approved as State-furnished material. However, since public agencies may not bid in competition with private firms, direct acquisition of materials from a

prison industry for use as State-furnished material is subject to a public interest finding with the Division Administrator's concurrence (23 CFR 635.407d). Selection of materials produced by convict labor as State-furnished materials for mandatory use should be cleared prior to the submittal of the Plans Specifications & Estimates (PS&E).

b. Patented/Proprietary Products References: 23 U.S.C. 112, 23 CFR 635.411

FHWA will not participate, directly or indirectly, in payment for any premium or royalty on any patented or proprietary material, specification, or process specifically set forth in the plans and specifications for a project, unless:

- the item is purchased or obtained through competitive bidding with equally suitable unpatented items,
- the STA certifies either that the proprietary or patented item is essential for synchronization with the existing highway facilities or that no equally suitable alternative exists, or
- the item is used for research or for a special type of construction on relatively short sections of road for experimental purposes. States should follow FHWA's procedures for "Construction Projects Incorporating Experimental Features" ([expermnt.htm](#)) for the submittal of work plans and evaluations.

The primary purpose of the policy is to have competition in selection of materials and allow for development of new materials and products. The policy further permits materials and products that are judged equal may be bid under generic specifications. If only patented or proprietary products are acceptable, they shall be bid as alternatives with all, or at least a reasonable number of, acceptable materials or products listed; and the Division Administrator may approve a single source if it can be found that its utilization is in the public interest.

Trade names are generally the key to identifying patented or proprietary materials. Trade name examples include 3M, Corten, etc. Generally, products identified by their brand or trade name are not to be specified without an "or equal" phrase, and, if trade names are used, all, or at least a reasonable number of acceptable "equal" materials or products should be listed. The licensing of several suppliers to produce a product does not change the fact that it is a single product and should not be specified to the exclusion of other equally suitable products.

c. State Preference References: 23 U.S.C. 112, 23 CFR 635.409

Materials produced within Maine shall not be favored to the exclusion of comparable materials produced outside of Maine. State preference clauses give particular advantage to the designated source and thus restrict competition. Therefore, State preference provisions shall not be used on any Federal-aid construction projects.

This policy also applies to State preference actions against materials of foreign origin, except as otherwise permitted by Federal law. Thus, States cannot give preference to in-State material sources over foreign material sources. Under the Buy America provisions, the States are

permitted to expand the Buy America restrictions provided that the STA is legally authorized under State law to impose more stringent requirements.

d. State Owned/Furnished/Designated Materials References: 23 U.S.C. 112, 23 CFR 635.407

Current FHWA policy requires that the contractor must furnish all materials to be incorporated in the work, and the contractor shall be permitted to select the sources from which the materials are to be obtained. Exceptions to this requirement may be made when there is a definite finding, by MaineDOT and concurred in by Federal Highway Administration's (FHWA) Division Administrator, that it is in the public interest to require the contractor to use materials furnished by the MaineDOT or from sources designated by MaineDOT. The exception policy can best be understood by separating State-furnished materials into the categories of manufactured materials and local natural materials.

Manufactured Materials When the use of State-furnished manufactured materials is approved based on a public interest finding, such use must be made mandatory. The optional use of State-furnished manufactured materials is in violation of our policy prohibiting public agencies from competing with private firms. Manufactured materials to be furnished by MaineDOT must be acquired through competitive bidding, unless there is a public interest finding for another method, and concurred in by FHWA's Division Administrator.

Local Natural Materials When MaineDOT owns or controls a local natural materials source such as a borrow pit or a stockpile of salvaged pavement material, etc., the materials may be designated for either optional or mandatory use; however, mandatory use will require a public interest finding (PIF) and FHWA's Division Administrator's concurrence.

In order to permit prospective bidders to properly prepare their bids, the location, cost, and any conditions to be met for obtaining materials that are made available to the contractor shall be stated in the bidding documents.

Mandatory Disposal Sites Normally, the disposal site for surplus excavated materials is to be of the contractor's choosing; although, an optional site(s) may be shown in the contract provisions. A mandatory site shall be specified when there is a finding by MaineDOT, with the concurrence of the Division Administrator, that such placement is the most economical or that the environment would be substantially enhanced without excessive cost. Discussion of the mandatory use of a disposal site in the environmental document may serve as the basis for the public interest finding.

Summarizing FHWA policy for the mandatory use of borrow or disposal sites:

- mandatory use of either requires a public interest finding and FHWA's Division Administrator's concurrence,
- mandatory use of either may be based on environmental consideration where the environment will be substantially enhanced without excessive additional cost, and
- where the use is based on environmental considerations, the discussion in the environmental document may be used as the basis for the public interest finding.

Factors to justify a public interest finding should include such items as cost effectiveness, system integrity, and local shortages of material.

C. Standard FHWA Contract Provisions - FHWA 1273

Unless expressly otherwise provided in the Bid Documents, the following “Required Contract Provisions, Federal Aid Construction Contracts”, FHWA-1273, are hereby incorporated into the Bid Documents and Contract.

Cargo Preference Act : Contractor and Subcontractor Clauses. “Use of United States-flag vessels: The contractor agrees—“(1) To utilize privately owned United States-flag commercial vessels to ship at least 50 percent of the gross tonnage (computed separately for dry bulk carriers, dry cargo liners, and tankers) involved, whenever shipping any equipment, material, or commodities pursuant to this contract, to the extent such vessels are available at fair and reasonable rates for United States-flag commercial vessels.”(2) To furnish within 20 days following the date of loading for shipments originating within the United States or within 30 working days following the date of loading for shipments originating outside the United States, a legible copy of a rated, ‘on-board’ commercial ocean bill-of-lading in English for each shipment of cargo described in paragraph (1) of this section to both the Contracting Officer (through the prime contractor in the case of subcontractor bills-of-lading) and to the Division of National Cargo, Office of Market Development, Maritime Administration, Washington, DC 20590.”(3) To insert the substance of the provisions of this clause in all subcontracts issued pursuant to this contract.”(Reorganization Plans No. 21 of 1950 (64 Stat. 1273) and No. 7 of 1961 (75 Stat. 840) as amended by Pub. L. 91-469 (84 Stat. 1036) and Department of Commerce Organization Order 10-8 (38 FR 19707, July 23, 1973)) [42 FR 57126, Nov. 1, 1977]

The Cargo Preference Act requirements apply to materials or equipment that are acquired for a specific Federal-aid highway project. In general, the requirements are not applicable to goods or materials that come into inventories independent of an FHWA funded-contract. For example, the requirements would not apply to shipments of Portland cement, asphalt cement, or aggregates, as industry suppliers and contractors use these materials to replenish existing inventories. In general, most of the materials used for highway construction originate from existing inventories and are not acquired solely for a specific Federal-aid project. However, if materials or equipment are acquired solely for a Federal-aid project, then the Cargo Preference Act requirements apply.”

Start of FHWA 1273 REQUIRED CONTRACT PROVISIONS
FEDERAL-AID CONSTRUCTION CONTRACTS (As revised through May 1, 2012)

FHWA-1273 -- Revised May 1, 2012

**REQUIRED CONTRACT PROVISIONS
FEDERAL-AID CONSTRUCTION CONTRACTS**

- I. General
- II. Nondiscrimination
- III. Nonsegregated Facilities
- IV. Davis-Bacon and Related Act Provisions
- V. Contract Work Hours and Safety Standards Act Provisions
- VI. Subletting or Assigning the Contract
- VII. Safety: Accident Prevention
- VIII. False Statements Concerning Highway Projects
- IX. Implementation of Clean Air Act and Federal Water Pollution Control Act
- X. Compliance with Governmentwide Suspension and Debarment Requirements
- XI. Certification Regarding Use of Contract Funds for Lobbying

ATTACHMENTS

A. Employment and Materials Preference for Appalachian Development Highway System or Appalachian Local Access Road Contracts (included in Appalachian contracts only)

I. GENERAL

1. Form FHWA-1273 must be physically incorporated in each construction contract funded under Title 23 (excluding emergency contracts solely intended for debris removal). The contractor (or subcontractor) must insert this form in each subcontract and further require its inclusion in all lower tier subcontracts (excluding purchase orders, rental agreements and other agreements for supplies or services).

The applicable requirements of Form FHWA-1273 are incorporated by reference for work done under any purchase order, rental agreement or agreement for other services. The prime contractor shall be responsible for compliance by any subcontractor, lower-tier subcontractor or service provider.

Form FHWA-1273 must be included in all Federal-aid design-build contracts, in all subcontracts and in lower tier subcontracts (excluding subcontracts for design services, purchase orders, rental agreements and other agreements for supplies or services). The design-builder shall be responsible for compliance by any subcontractor, lower-tier subcontractor or service provider.

Contracting agencies may reference Form FHWA-1273 in bid proposal or request for proposal documents, however, the Form FHWA-1273 must be physically incorporated (not referenced) in all contracts, subcontracts and lower-tier subcontracts (excluding purchase orders, rental agreements and other agreements for supplies or services related to a construction contract).

2. Subject to the applicability criteria noted in the following sections, these contract provisions shall apply to all work performed on the contract by the contractor's own organization and with the assistance of workers under the contractor's immediate superintendence and to all work performed on the contract by piecework, station work, or by subcontract.

3. A breach of any of the stipulations contained in these Required Contract Provisions may be sufficient grounds for withholding of progress payments, withholding of final payment,

termination of the contract, suspension / debarment or any other action determined to be appropriate by the contracting agency and FHWA.

4. Selection of Labor: During the performance of this contract, the contractor shall not use convict labor for any purpose within the limits of a construction project on a Federal-aid highway unless it is labor performed by convicts who are on parole, supervised release, or probation. The term Federal-aid highway does not include roadways functionally classified as local roads or rural minor collectors.

II. NONDISCRIMINATION

The provisions of this section related to 23 CFR Part 230 are applicable to all Federal-aid construction contracts and to all related construction subcontracts of \$10,000 or more. The provisions of 23 CFR Part 230 are not applicable to material supply, engineering, or architectural service contracts.

In addition, the contractor and all subcontractors must comply with the following policies: Executive Order 11246, 41 CFR 60, 29 CFR 1625-1627, Title 23 USC Section 140, the Rehabilitation Act of 1973, as amended (29 USC 794), Title VI of the Civil Rights Act of 1964, as amended, and related regulations including 49 CFR Parts 21, 26 and 27; and 23 CFR Parts 200, 230, and 633.

The contractor and all subcontractors must comply with: the requirements of the Equal Opportunity Clause in 41 CFR 60-1.4(b) and, for all construction contracts exceeding \$10,000, the Standard Federal Equal Employment Opportunity Construction Contract Specifications in 41 CFR 60-4.3.

Note: The U.S. Department of Labor has exclusive authority to determine compliance with Executive Order 11246 and the policies of the Secretary of Labor including 41 CFR 60, and 29 CFR 1625-1627. The contracting agency and the FHWA have the authority and the responsibility to ensure compliance with Title 23 USC Section 140, the Rehabilitation Act of 1973, as amended (29 USC 794), and Title VI of the Civil Rights Act of 1964, as amended, and related regulations including 49 CFR Parts 21, 26 and 27; and 23 CFR Parts 200, 230, and 633.

The following provision is adopted from 23 CFR 230, Appendix A, with appropriate revisions to conform to the U.S. Department of Labor (US DOL) and FHWA requirements.

1. Equal Employment Opportunity: Equal employment opportunity (EEO) requirements not to discriminate and to take affirmative action to assure equal opportunity as set forth under laws, executive orders, rules, regulations (28 CFR 35, 29 CFR 1630, 29 CFR 1625-1627, 41 CFR 60 and 49 CFR 27) and orders of the Secretary of Labor as modified by the provisions prescribed herein, and imposed pursuant to 23 U.S.C. 140 shall constitute the EEO and specific affirmative action standards for the contractor's project activities under this contract. The provisions of the Americans with Disabilities Act of 1990 (42 U.S.C. 12101 et seq.) set forth under 28 CFR 35 and 29 CFR 1630 are incorporated by reference in this contract. In the execution of this contract, the contractor agrees to comply with the following minimum specific requirement activities of EEO:

a. The contractor will work with the contracting agency and the Federal Government to ensure that it has made every good faith effort to provide equal opportunity with respect to all of its terms and conditions of employment and in their review of activities under the contract.

b. The contractor will accept as its operating policy the following statement:

"It is the policy of this Company to assure that applicants are employed, and that employees are treated during employment, without regard to their race, religion, sex, color, national origin, age or disability. Such action shall include: employment, upgrading, demotion, or transfer; recruitment or recruitment advertising; layoff or termination; rates of pay or other forms of compensation; and selection for training, including apprenticeship, pre-apprenticeship, and/or on-the-job training."

2. EEO Officer: The contractor will designate and make known to the contracting officers an EEO Officer who will have the responsibility for and must be capable of effectively administering and promoting an active EEO program and who must be assigned adequate authority and responsibility to do so.

3. Dissemination of Policy: All members of the contractor's staff who are authorized to hire, supervise, promote, and discharge employees, or who recommend such action, or who are substantially involved in such action, will be made fully cognizant of, and will implement, the contractor's EEO policy and contractual responsibilities to provide EEO in each grade and classification of employment. To ensure that the above agreement will be met, the following actions will be taken as a minimum:

a. Periodic meetings of supervisory and personnel office employees will be conducted before the start of work and then not less often than once every six months, at which time the contractor's EEO policy and its implementation will be reviewed and explained. The meetings will be conducted by the EEO Officer.

b. All new supervisory or personnel office employees will be given a thorough indoctrination by the EEO Officer, covering all major aspects of the contractor's EEO obligations within thirty days following their reporting for duty with the contractor.

c. All personnel who are engaged in direct recruitment for the project will be instructed by the EEO Officer in the contractor's procedures for locating and hiring minorities and women.

d. Notices and posters setting forth the contractor's EEO policy will be placed in areas readily accessible to employees, applicants for employment and potential employees.

e. The contractor's EEO policy and the procedures to implement such policy will be brought to the attention of employees by means of meetings, employee handbooks, or other appropriate means.

4. Recruitment: When advertising for employees, the contractor will include in all advertisements for employees the notation: "An Equal Opportunity Employer." All such advertisements will be placed in publications having a large circulation among minorities and women in the area from which the project work force would normally be derived.

- a. The contractor will, unless precluded by a valid bargaining agreement, conduct systematic and direct recruitment through public and private employee referral sources likely to yield qualified minorities and women. To meet this requirement, the contractor will identify sources of potential minority group employees, and establish with such identified sources procedures whereby minority and women applicants may be referred to the contractor for employment consideration.
- b. In the event the contractor has a valid bargaining agreement providing for exclusive hiring hall referrals, the contractor is expected to observe the provisions of that agreement to the extent that the system meets the contractor's compliance with EEO contract provisions. Where implementation of such an agreement has the effect of discriminating against minorities or women, or obligates the contractor to do the same, such implementation violates Federal nondiscrimination provisions.
- c. The contractor will encourage its present employees to refer minorities and women as applicants for employment. Information and procedures with regard to referring such applicants will be discussed with employees.

5. Personnel Actions: Wages, working conditions, and employee benefits shall be established and administered, and personnel actions of every type, including hiring, upgrading, promotion, transfer, demotion, layoff, and termination, shall be taken without regard to race, color, religion, sex, national origin, age or disability.

The following procedures shall be followed:

- a. The contractor will conduct periodic inspections of project sites to insure that working conditions and employee facilities do not indicate discriminatory treatment of project site personnel.
- b. The contractor will periodically evaluate the spread of wages paid within each classification to determine any evidence of discriminatory wage practices.
- c. The contractor will periodically review selected personnel actions in depth to determine whether there is evidence of discrimination. Where evidence is found, the contractor will promptly take corrective action. If the review indicates that the discrimination may extend beyond the actions reviewed, such corrective action shall include all affected persons.
- d. The contractor will promptly investigate all complaints of alleged discrimination made to the contractor in connection with its obligations under this contract, will attempt to resolve such complaints, and will take appropriate corrective action within a reasonable time. If the investigation indicates that the discrimination may affect persons other than the complainant, such corrective action shall include such other persons. Upon completion of each investigation, the contractor will inform every complainant of all of their avenues of appeal.

6. Training and Promotion:

a. The contractor will assist in locating, qualifying, and increasing the skills of minorities and women who are applicants for employment or current employees. Such efforts should be aimed at developing full journey level status employees in the type of trade or job classification involved.

b. Consistent with the contractor's work force requirements and as permissible under Federal and State regulations, the contractor shall make full use of training programs, i.e., apprenticeship, and on-the-job training programs for the geographical area of contract performance. In the event a special provision for training is provided under this contract, this subparagraph will be superseded as indicated in the special provision. The contracting agency may reserve training positions for persons who receive welfare assistance in accordance with 23 U.S.C. 140(a).

c. The contractor will advise employees and applicants for employment of available training programs and entrance requirements for each.

d. The contractor will periodically review the training and promotion potential of employees who are minorities and women and will encourage eligible employees to apply for such training and promotion.

7. Unions: If the contractor relies in whole or in part upon unions as a source of employees, the contractor will use good faith efforts to obtain the cooperation of such unions to increase opportunities for minorities and women.

Actions by the contractor, either directly or through a contractor's association acting as agent, will include the procedures set forth below:

a. The contractor will use good faith efforts to develop, in cooperation with the unions, joint training programs aimed toward qualifying more minorities and women for membership in the unions and increasing the skills of minorities and women so that they may qualify for higher paying employment.

b. The contractor will use good faith efforts to incorporate an EEO clause into each union agreement to the end that such union will be contractually bound to refer applicants without regard to their race, color, religion, sex, national origin, age or disability.

c. The contractor is to obtain information as to the referral practices and policies of the labor union except that to the extent such information is within the exclusive possession of the labor union and such labor union refuses to furnish such information to the contractor, the contractor shall so certify to the contracting agency and shall set forth what efforts have been made to obtain such information.

d. In the event the union is unable to provide the contractor with a reasonable flow of referrals within the time limit set forth in the collective bargaining agreement, the contractor will, through independent recruitment efforts, fill the employment vacancies without regard to race, color, religion, sex, national origin, age or disability; making full efforts to obtain qualified and/or qualifiable minorities and women. The failure of a union to provide sufficient referrals (even

though it is obligated to provide exclusive referrals under the terms of a collective bargaining agreement) does not relieve the contractor from the requirements of this paragraph. In the event the union referral practice prevents the contractor from meeting the obligations pursuant to Executive Order 11246, as amended, and these special provisions, such contractor shall immediately notify the contracting agency.

8. Reasonable Accommodation for Applicants / Employees with Disabilities: The contractor must be familiar with the requirements for and comply with the Americans with Disabilities Act and all rules and regulations established there under. Employers must provide reasonable accommodation in all employment activities unless to do so would cause an undue hardship.

9. Selection of Subcontractors, Procurement of Materials and Leasing of Equipment: The contractor shall not discriminate on the grounds of race, color, religion, sex, national origin, age or disability in the selection and retention of subcontractors, including procurement of materials and leases of equipment. The contractor shall take all necessary and reasonable steps to ensure nondiscrimination in the administration of this contract.

a. The contractor shall notify all potential subcontractors and suppliers and lessors of their EEO obligations under this contract.

b. The contractor will use good faith efforts to ensure subcontractor compliance with their EEO obligations.

10. Assurance Required by 49 CFR 26.13(b):

a. The requirements of 49 CFR Part 26 and the State DOT's U.S. DOT-approved DBE program are incorporated by reference.

b. The contractor or subcontractor shall not discriminate on the basis of race, color, national origin, or sex in the performance of this contract. The contractor shall carry out applicable requirements of 49 CFR Part 26 in the award and administration of DOT-assisted contracts. Failure by the contractor to carry out these requirements is a material breach of this contract, which may result in the termination of this contract or such other remedy as the contracting agency deems appropriate.

11. Records and Reports: The contractor shall keep such records as necessary to document compliance with the EEO requirements. Such records shall be retained for a period of three years following the date of the final payment to the contractor for all contract work and shall be available at reasonable times and places for inspection by authorized representatives of the contracting agency and the FHWA.

a. The records kept by the contractor shall document the following:

(1) The number and work hours of minority and non-minority group members and women employed in each work classification on the project;

(2) The progress and efforts being made in cooperation with unions, when applicable, to increase employment opportunities for minorities and women; and

(3) The progress and efforts being made in locating, hiring, training, qualifying, and upgrading minorities and women;

b. The contractors and subcontractors will submit an annual report to the contracting agency each July for the duration of the project, indicating the number of minority, women, and non-minority group employees currently engaged in each work classification required by the contract work. This information is to be reported on [Form FHWA-1391](#). The staffing data should represent the project work force on board in all or any part of the last payroll period preceding the end of July. If on-the-job training is being required by special provision, the contractor will be required to collect and report training data. The employment data should reflect the work force on board during all or any part of the last payroll period preceding the end of July.

III. NONSEGREGATED FACILITIES

This provision is applicable to all Federal-aid construction contracts and to all related construction subcontracts of \$10,000 or more.

The contractor must ensure that facilities provided for employees are provided in such a manner that segregation on the basis of race, color, religion, sex, or national origin cannot result. The contractor may neither require such segregated use by written or oral policies nor tolerate such use by employee custom. The contractor's obligation extends further to ensure that its employees are not assigned to perform their services at any location, under the contractor's control, where the facilities are segregated. The term "facilities" includes waiting rooms, work areas, restaurants and other eating areas, time clocks, restrooms, washrooms, locker rooms, and other storage or dressing areas, parking lots, drinking fountains, recreation or entertainment areas, transportation, and housing provided for employees. The contractor shall provide separate or single-user restrooms and necessary dressing or sleeping areas to assure privacy between sexes.

IV. DAVIS-BACON AND RELATED ACT PROVISIONS

This section is applicable to all Federal-aid construction projects exceeding \$2,000 and to all related subcontracts and lower-tier subcontracts (regardless of subcontract size). The requirements apply to all projects located within the right-of-way of a roadway that is functionally classified as Federal-aid highway. This excludes roadways functionally classified as local roads or rural minor collectors, which are exempt. Contracting agencies may elect to apply these requirements to other projects.

The following provisions are from the U.S. Department of Labor regulations in 29 CFR 5.5 "Contract provisions and related matters" with minor revisions to conform to the FHWA-1273 format and FHWA program requirements.

1. Minimum wages

a. All laborers and mechanics employed or working upon the site of the work, will be paid unconditionally and not less often than once a week, and without subsequent deduction or rebate on any account (except such payroll deductions as are permitted by regulations issued by the Secretary of Labor under the Copeland Act (29 CFR part 3)), the full amount of wages and bona fide fringe benefits (or cash equivalents thereof) due at time of payment computed at rates not less than those contained in the wage determination of the Secretary of Labor which is attached hereto and made a part hereof, regardless of any contractual relationship which may be alleged to exist between the contractor and such laborers and mechanics.

Contributions made or costs reasonably anticipated for bona fide fringe benefits under section 1(b)(2) of the Davis-Bacon Act on behalf of laborers or mechanics are considered wages paid to such laborers or mechanics, subject to the provisions of paragraph 1.d. of this section; also, regular contributions made or costs incurred for more than a weekly period (but not less often than quarterly) under plans, funds, or programs which cover the particular weekly period, are deemed to be constructively made or incurred during such weekly period. Such laborers and mechanics shall be paid the appropriate wage rate and fringe benefits on the wage determination for the classification of work actually performed, without regard to skill, except as provided in 29 CFR 5.5(a)(4). Laborers or mechanics performing work in more than one classification may be compensated at the rate specified for each classification for the time actually worked therein: Provided, That the employer's payroll records accurately set forth the time spent in each classification in which work is performed. The wage determination (including any additional classification and wage rates conformed under paragraph 1.b. of this section) and the Davis-Bacon poster (WH-1321) shall be posted at all times by the contractor and its subcontractors at the site of the work in a prominent and accessible place where it can be easily seen by the workers.

b. (1) The contracting officer shall require that any class of laborers or mechanics, including helpers, which is not listed in the wage determination and which is to be employed under the contract shall be classified in conformance with the wage determination. The contracting officer shall approve an additional classification and wage rate and fringe benefits therefore only when the following criteria have been met:

- (i) The work to be performed by the classification requested is not performed by a classification in the wage determination; and
- (ii) The classification is utilized in the area by the construction industry; and
- (iii) The proposed wage rate, including any bona fide fringe benefits, bears a reasonable relationship to the wage rates contained in the wage determination.

(2) If the contractor and the laborers and mechanics to be employed in the classification (if known), or their representatives, and the contracting officer agree on the classification and wage rate (including the amount designated for fringe benefits where appropriate), a report of the action taken shall be sent by the contracting officer to the Administrator of the Wage and Hour Division, Employment Standards Administration, U.S. Department of Labor, Washington, DC 20210. The Administrator, or an authorized representative, will approve, modify, or disapprove every additional classification action within 30 days of receipt and so advise the contracting officer or will notify the contracting officer within the 30-day period that additional time is necessary.

(3) In the event the contractor, the laborers or mechanics to be employed in the classification or their representatives, and the contracting officer do not agree on the proposed classification and wage rate (including the amount designated for fringe benefits, where appropriate), the contracting officer shall refer the questions, including the views of all interested parties and the recommendation of the contracting officer, to the Wage and Hour Administrator for determination. The Wage and Hour Administrator, or an authorized representative, will issue a determination within 30 days of receipt and so advise the contracting officer or will notify the contracting officer within the 30-day period that additional time is necessary.

(4) The wage rate (including fringe benefits where appropriate) determined pursuant to paragraphs 1.b.(2) or 1.b.(3) of this section, shall be paid to all workers performing work in the classification under this contract from the first day on which work is performed in the classification.

c. Whenever the minimum wage rate prescribed in the contract for a class of laborers or mechanics includes a fringe benefit which is not expressed as an hourly rate, the contractor shall either pay the benefit as stated in the wage determination or shall pay another bona fide fringe benefit or an hourly cash equivalent thereof.

d. If the contractor does not make payments to a trustee or other third person, the contractor may consider as part of the wages of any laborer or mechanic the amount of any costs reasonably anticipated in providing bona fide fringe benefits under a plan or program, Provided, That the Secretary of Labor has found, upon the written request of the contractor, that the applicable standards of the Davis-Bacon Act have been met. The Secretary of Labor may require the contractor to set aside in a separate account assets for the meeting of obligations under the plan or program.

2. Withholding

The contracting agency shall upon its own action or upon written request of an authorized representative of the Department of Labor, withhold or cause to be withheld from the contractor under this contract, or any other Federal contract with the same prime contractor, or any other federally-assisted contract subject to Davis-Bacon prevailing wage requirements, which is held by the same prime contractor, so much of the accrued payments or advances as may be considered necessary to pay laborers and mechanics, including apprentices, trainees, and helpers, employed by the contractor or any subcontractor the full amount of wages required by the contract. In the event of failure to pay any laborer or mechanic, including any apprentice, trainee, or helper, employed or working on the site of the work, all or part of the wages required by the contract, the contracting agency may, after written notice to the contractor, take such action as may be necessary to cause the suspension of any further payment, advance, or guarantee of funds until such violations have ceased.

3. Payrolls and basic records

a. Payrolls and basic records relating thereto shall be maintained by the contractor during the course of the work and preserved for a period of three years thereafter for all laborers and mechanics working at the site of the work. Such records shall contain the name, address, and social security number of each such worker, his or her correct classification, hourly rates of wages paid (including rates of contributions or costs anticipated for bona fide fringe benefits or cash equivalents thereof of the types described in section 1(b)(2)(B) of the Davis-Bacon Act),

daily and weekly number of hours worked, deductions made and actual wages paid. Whenever the Secretary of Labor has found under 29 CFR 5.5(a)(1)(iv) that the wages of any laborer or mechanic include the amount of any costs reasonably anticipated in providing benefits under a plan or program described in section 1(b)(2)(B) of the Davis-Bacon Act, the contractor shall maintain records which show that the commitment to provide such benefits is enforceable, that the plan or program is financially responsible, and that the plan or program has been communicated in writing to the laborers or mechanics affected, and records which show the costs anticipated or the actual cost incurred in providing such benefits. Contractors employing apprentices or trainees under approved programs shall maintain written evidence of the registration of apprenticeship programs and certification of trainee programs, the registration of the apprentices and trainees, and the ratios and wage rates prescribed in the applicable programs.

b. (1) The contractor shall submit weekly for each week in which any contract work is performed a copy of all payrolls to the contracting agency. The payrolls submitted shall set out accurately and completely all of the information required to be maintained under 29 CFR 5.5(a)(3)(i), except that full social security numbers and home addresses shall not be included on weekly transmittals. Instead the payrolls shall only need to include an individually identifying number for each employee (e.g. , the last four digits of the employee's social security number). The required weekly payroll information may be submitted in any form desired. Optional Form WH-347 is available for this purpose from the Wage and Hour Division Web site at <http://www.dol.gov/esa/whd/forms/wh347instr.htm> or its successor site. The prime contractor is responsible for the submission of copies of payrolls by all subcontractors. Contractors and subcontractors shall maintain the full social security number and current address of each covered worker, and shall provide them upon request to the contracting agency for transmission to the State DOT, the FHWA or the Wage and Hour Division of the Department of Labor for purposes of an investigation or audit of compliance with prevailing wage requirements. It is not a violation of this section for a prime contractor to require a subcontractor to provide addresses and social security numbers to the prime contractor for its own records, without weekly submission to the contracting agency..

(2) Each payroll submitted shall be accompanied by a “Statement of Compliance,” signed by the contractor or subcontractor or his or her agent who pays or supervises the payment of the persons employed under the contract and shall certify the following:

(i) That the payroll for the payroll period contains the information required to be provided under §5.5 (a)(3)(ii) of Regulations, 29 CFR part 5, the appropriate information is being maintained under §5.5 (a)(3)(i) of Regulations, 29 CFR part 5, and that such information is correct and complete;

(ii) That each laborer or mechanic (including each helper, apprentice, and trainee) employed on the contract during the payroll period has been paid the full weekly wages earned, without rebate, either directly or indirectly, and that no deductions have been made either directly or indirectly from the full wages earned, other than permissible deductions as set forth in Regulations, 29 CFR part 3;

(iii) That each laborer or mechanic has been paid not less than the applicable wage rates and fringe benefits or cash equivalents for the classification of work performed, as specified in the applicable wage determination incorporated into the contract.

(3) The weekly submission of a properly executed certification set forth on the reverse side of Optional Form WH-347 shall satisfy the requirement for submission of the “Statement of Compliance” required by paragraph 3.b.(2) of this section.

(4) The falsification of any of the above certifications may subject the contractor or subcontractor to civil or criminal prosecution under section 1001 of title 18 and section 231 of title 31 of the United States Code.

c. The contractor or subcontractor shall make the records required under paragraph 3.a. of this section available for inspection, copying, or transcription by authorized representatives of the contracting agency, the State DOT, the FHWA, or the Department of Labor, and shall permit such representatives to interview employees during working hours on the job. If the contractor or subcontractor fails to submit the required records or to make them available, the FHWA may, after written notice to the contractor, the contracting agency or the State DOT, take such action as may be necessary to cause the suspension of any further payment, advance, or guarantee of funds. Furthermore, failure to submit the required records upon request or to make such records available may be grounds for debarment action pursuant to 29 CFR 5.12.

4. Apprentices and trainees

a. Apprentices (programs of the USDOL).

Apprentices will be permitted to work at less than the predetermined rate for the work they performed when they are employed pursuant to and individually registered in a bona fide apprenticeship program registered with the U.S. Department of Labor, Employment and Training Administration, Office of Apprenticeship Training, Employer and Labor Services, or with a State Apprenticeship Agency recognized by the Office, or if a person is employed in his or her first 90 days of probationary employment as an apprentice in such an apprenticeship program, who is not individually registered in the program, but who has been certified by the Office of Apprenticeship Training, Employer and Labor Services or a State Apprenticeship Agency (where appropriate) to be eligible for probationary employment as an apprentice.

The allowable ratio of apprentices to journeymen on the job site in any craft classification shall not be greater than the ratio permitted to the contractor as to the entire work force under the registered program. Any worker listed on a payroll at an apprentice wage rate, who is not registered or otherwise employed as stated above, shall be paid not less than the applicable wage rate on the wage determination for the classification of work actually performed. In addition, any apprentice performing work on the job site in excess of the ratio permitted under the registered program shall be paid not less than the applicable wage rate on the wage determination for the work actually performed. Where a contractor is performing construction on a project in a locality other than that in which its program is registered, the ratios and wage rates (expressed in percentages of the journeyman's hourly rate) specified in the contractor's or subcontractor's registered program shall be observed.

Every apprentice must be paid at not less than the rate specified in the registered program for the apprentice's level of progress, expressed as a percentage of the journeymen hourly rate specified in the applicable wage determination. Apprentices shall be paid fringe benefits in accordance with the provisions of the apprenticeship program. If the apprenticeship program does not specify fringe benefits, apprentices must be paid the full amount of fringe benefits listed on the wage determination for the applicable classification. If the Administrator determines that a

different practice prevails for the applicable apprentice classification, fringes shall be paid in accordance with that determination.

In the event the Office of Apprenticeship Training, Employer and Labor Services, or a State Apprenticeship Agency recognized by the Office, withdraws approval of an apprenticeship program, the contractor will no longer be permitted to utilize apprentices at less than the applicable predetermined rate for the work performed until an acceptable program is approved.

b. Trainees (programs of the USDOL).

Except as provided in 29 CFR 5.16, trainees will not be permitted to work at less than the predetermined rate for the work performed unless they are employed pursuant to and individually registered in a program which has received prior approval, evidenced by formal certification by the U.S. Department of Labor, Employment and Training Administration.

The ratio of trainees to journeymen on the job site shall not be greater than permitted under the plan approved by the Employment and Training Administration.

Every trainee must be paid at not less than the rate specified in the approved program for the trainee's level of progress, expressed as a percentage of the journeyman hourly rate specified in the applicable wage determination. Trainees shall be paid fringe benefits in accordance with the provisions of the trainee program. If the trainee program does not mention fringe benefits, trainees shall be paid the full amount of fringe benefits listed on the wage determination unless the Administrator of the Wage and Hour Division determines that there is an apprenticeship program associated with the corresponding journeyman wage rate on the wage determination which provides for less than full fringe benefits for apprentices. Any employee listed on the payroll at a trainee rate who is not registered and participating in a training plan approved by the Employment and Training Administration shall be paid not less than the applicable wage rate on the wage determination for the classification of work actually performed. In addition, any trainee performing work on the job site in excess of the ratio permitted under the registered program shall be paid not less than the applicable wage rate on the wage determination for the work actually performed.

In the event the Employment and Training Administration withdraws approval of a training program, the contractor will no longer be permitted to utilize trainees at less than the applicable predetermined rate for the work performed until an acceptable program is approved.

c. Equal employment opportunity. The utilization of apprentices, trainees and journeymen under this part shall be in conformity with the equal employment opportunity requirements of Executive Order 11246, as amended, and 29 CFR part 30.

d. Apprentices and Trainees (programs of the U.S. DOT).

Apprentices and trainees working under apprenticeship and skill training programs which have been certified by the Secretary of Transportation as promoting EEO in connection with Federal-aid highway construction programs are not subject to the requirements of paragraph 4 of this Section IV. The straight time hourly wage rates for apprentices and trainees under such programs will be established by the particular programs. The ratio of apprentices and trainees to journeymen shall not be greater than permitted by the terms of the particular program.

5. Compliance with Copeland Act requirements. The contractor shall comply with the requirements of 29 CFR part 3, which are incorporated by reference in this contract.

6. Subcontracts. The contractor or subcontractor shall insert Form FHWA-1273 in any subcontracts and also require the subcontractors to include Form FHWA-1273 in any lower tier subcontracts. The prime contractor shall be responsible for the compliance by any subcontractor or lower tier subcontractor with all the contract clauses in 29 CFR 5.5.

7. Contract termination: debarment. A breach of the contract clauses in 29 CFR 5.5 may be grounds for termination of the contract, and for debarment as a contractor and a subcontractor as provided in 29 CFR 5.12.

8. Compliance with Davis-Bacon and Related Act requirements. All rulings and interpretations of the Davis-Bacon and Related Acts contained in 29 CFR parts 1, 3, and 5 are herein incorporated by reference in this contract.

9. Disputes concerning labor standards. Disputes arising out of the labor standards provisions of this contract shall not be subject to the general disputes clause of this contract. Such disputes shall be resolved in accordance with the procedures of the Department of Labor set forth in 29 CFR parts 5, 6, and 7. Disputes within the meaning of this clause include disputes between the contractor (or any of its subcontractors) and the contracting agency, the U.S. Department of Labor, or the employees or their representatives.

10. Certification of eligibility.

a. By entering into this contract, the contractor certifies that neither it (nor he or she) nor any person or firm who has an interest in the contractor's firm is a person or firm ineligible to be awarded Government contracts by virtue of section 3(a) of the Davis-Bacon Act or 29 CFR 5.12(a)(1).

b. No part of this contract shall be subcontracted to any person or firm ineligible for award of a Government contract by virtue of section 3(a) of the Davis-Bacon Act or 29 CFR 5.12(a)(1).

c. The penalty for making false statements is prescribed in the U.S. Criminal Code, 18 U.S.C. 1001.

V. CONTRACT WORK HOURS AND SAFETY STANDARDS ACT

The following clauses apply to any Federal-aid construction contract in an amount in excess of \$100,000 and subject to the overtime provisions of the Contract Work Hours and Safety Standards Act. These clauses shall be inserted in addition to the clauses required by 29 CFR 5.5(a) or 29 CFR 4.6. As used in this paragraph, the terms laborers and mechanics include watchmen and guards.

1. Overtime requirements. No contractor or subcontractor contracting for any part of the contract work which may require or involve the employment of laborers or mechanics shall require or permit any such laborer or mechanic in any workweek in which he or she is employed on such work to work in excess of forty hours in such workweek unless such laborer or mechanic receives compensation at a rate not less than one and one-half times the basic rate of pay for all hours worked in excess of forty hours in such workweek.

2. Violation; liability for unpaid wages; liquidated damages. In the event of any violation of the clause set forth in paragraph (1.) of this section, the contractor and any subcontractor responsible therefor shall be liable for the unpaid wages. In addition, such contractor and subcontractor shall be liable to the United States (in the case of work done under contract for the District of Columbia or a territory, to such District or to such territory), for liquidated damages. Such liquidated damages shall be computed with respect to each individual laborer or mechanic, including watchmen and guards, employed in violation of the clause set forth in paragraph (1.) of this section, in the sum of \$10 for each calendar day on which such individual was required or permitted to work in excess of the standard workweek of forty hours without payment of the overtime wages required by the clause set forth in paragraph (1.) of this section.

3. Withholding for unpaid wages and liquidated damages. The FHWA or the contacting agency shall upon its own action or upon written request of an authorized representative of the Department of Labor withhold or cause to be withheld, from any moneys payable on account of work performed by the contractor or subcontractor under any such contract or any other Federal contract with the same prime contractor, or any other federally-assisted contract subject to the Contract Work Hours and Safety Standards Act, which is held by the same prime contractor, such sums as may be determined to be necessary to satisfy any liabilities of such contractor or subcontractor for unpaid wages and liquidated damages as provided in the clause set forth in paragraph (2.) of this section.

4. Subcontracts. The contractor or subcontractor shall insert in any subcontracts the clauses set forth in paragraph (1.) through (4.) of this section and also a clause requiring the subcontractors to include these clauses in any lower tier subcontracts. The prime contractor shall be responsible for compliance by any subcontractor or lower tier subcontractor with the clauses set forth in paragraphs (1.) through (4.) of this section.

VI. SUBLETTING OR ASSIGNING THE CONTRACT

This provision is applicable to all Federal-aid construction contracts on the National Highway System.

1. The contractor shall perform with its own organization contract work amounting to not less than 30 percent (or a greater percentage if specified elsewhere in the contract) of the total original contract price, excluding any specialty items designated by the contracting agency. Specialty items may be performed by subcontract and the amount of any such specialty items performed may be deducted from the total original contract price before computing the amount of work required to be performed by the contractor's own organization (23 CFR 635.116).

a. The term “perform work with its own organization” refers to workers employed or leased by the prime contractor, and equipment owned or rented by the prime contractor, with or without operators. Such term does not include employees or equipment of a subcontractor or lower tier subcontractor, agents of the prime contractor, or any other assignees. The term may include payments for the costs of hiring leased employees from an employee leasing firm meeting all relevant Federal and State regulatory requirements. Leased employees may only be included in this term if the prime contractor meets all of the following conditions:

- (1) the prime contractor maintains control over the supervision of the day-to-day activities of the leased employees;
- (2) the prime contractor remains responsible for the quality of the work of the leased employees;
- (3) the prime contractor retains all power to accept or exclude individual employees from work on the project; and
- (4) the prime contractor remains ultimately responsible for the payment of predetermined minimum wages, the submission of payrolls, statements of compliance and all other Federal regulatory requirements.

b. "Specialty Items" shall be construed to be limited to work that requires highly specialized knowledge, abilities, or equipment not ordinarily available in the type of contracting organizations qualified and expected to bid or propose on the contract as a whole and in general are to be limited to minor components of the overall contract.

2. The contract amount upon which the requirements set forth in paragraph (1) of Section VI is computed includes the cost of material and manufactured products which are to be purchased or produced by the contractor under the contract provisions.

3. The contractor shall furnish (a) a competent superintendent or supervisor who is employed by the firm, has full authority to direct performance of the work in accordance with the contract requirements, and is in charge of all construction operations (regardless of who performs the work) and (b) such other of its own organizational resources (supervision, management, and engineering services) as the contracting officer determines is necessary to assure the performance of the contract.

4. No portion of the contract shall be sublet, assigned or otherwise disposed of except with the written consent of the contracting officer, or authorized representative, and such consent when given shall not be construed to relieve the contractor of any responsibility for the fulfillment of the contract. Written consent will be given only after the contracting agency has assured that each subcontract is evidenced in writing and that it contains all pertinent provisions and requirements of the prime contract.

5. The 30% self-performance requirement of paragraph (1) is not applicable to design-build contracts; however, contracting agencies may establish their own self-performance requirements.

VII. SAFETY: ACCIDENT PREVENTION

This provision is applicable to all Federal-aid construction contracts and to all related subcontracts.

1. In the performance of this contract the contractor shall comply with all applicable Federal, State, and local laws governing safety, health, and sanitation (23 CFR 635). The contractor shall provide all safeguards, safety devices and protective equipment and take any other needed actions as it determines, or as the contracting officer may determine, to be reasonably necessary to protect the life and health of employees on the job and the safety of the public and to protect property in connection with the performance of the work covered by the contract.

2. It is a condition of this contract, and shall be made a condition of each subcontract, which the contractor enters into pursuant to this contract, that the contractor and any subcontractor shall not permit any employee, in performance of the contract, to work in surroundings or under conditions which are unsanitary, hazardous or dangerous to his/her health or safety, as determined under construction safety and health standards (29 CFR 1926) promulgated by the Secretary of Labor, in accordance with Section 107 of the Contract Work Hours and Safety Standards Act (40 U.S.C. 3704).

3. Pursuant to 29 CFR 1926.3, it is a condition of this contract that the Secretary of Labor or authorized representative thereof, shall have right of entry to any site of contract performance to inspect or investigate the matter of compliance with the construction safety and health standards and to carry out the duties of the Secretary under Section 107 of the Contract Work Hours and Safety Standards Act (40 U.S.C.3704).

VIII. FALSE STATEMENTS CONCERNING HIGHWAY PROJECTS

This provision is applicable to all Federal-aid construction contracts and to all related subcontracts.

In order to assure high quality and durable construction in conformity with approved plans and specifications and a high degree of reliability on statements and representations made by engineers, contractors, suppliers, and workers on Federal-aid highway projects, it is essential that all persons concerned with the project perform their functions as carefully, thoroughly, and honestly as possible. Willful falsification, distortion, or misrepresentation with respect to any facts related to the project is a violation of Federal law. To prevent any misunderstanding regarding the seriousness of these and similar acts, Form FHWA-1022 shall be posted on each Federal-aid highway project (23 CFR 635) in one or more places where it is readily available to all persons concerned with the project:

18 U.S.C. 1020 reads as follows:

"Whoever, being an officer, agent, or employee of the United States, or of any State or Territory, or whoever, whether a person, association, firm, or corporation, knowingly makes any false statement, false representation, or false report as to the character, quality, quantity, or cost of the material used or to be used, or the quantity or quality of the work performed or to be performed, or the cost thereof in connection with the submission of plans, maps, specifications, contracts, or costs of construction on any highway or related project submitted for approval to the Secretary of Transportation; or

Whoever knowingly makes any false statement, false representation, false report or false claim with respect to the character, quality, quantity, or cost of any work performed or to be performed, or materials furnished or to be furnished, in connection with the construction of any highway or related project approved by the Secretary of Transportation; or

Whoever knowingly makes any false statement or false representation as to material fact in any statement, certificate, or report submitted pursuant to provisions of the Federal-aid Roads Act approved July 1, 1916, (39 Stat. 355), as amended and supplemented;

Shall be fined under this title or imprisoned not more than 5 years or both."

IX. IMPLEMENTATION OF CLEAN AIR ACT AND FEDERAL WATER POLLUTION CONTROL ACT

This provision is applicable to all Federal-aid construction contracts and to all related subcontracts.

By submission of this bid/proposal or the execution of this contract, or subcontract, as appropriate, the bidder, proposer, Federal-aid construction contractor, or subcontractor, as appropriate, will be deemed to have stipulated as follows:

1. That any person who is or will be utilized in the performance of this contract is not prohibited from receiving an award due to a violation of Section 508 of the Clean Water Act or Section 306 of the Clean Air Act.
2. That the contractor agrees to include or cause to be included the requirements of paragraph (1) of this Section X in every subcontract, and further agrees to take such action as the contracting agency may direct as a means of enforcing such requirements.

X. CERTIFICATION REGARDING DEBARMENT, SUSPENSION, INELIGIBILITY AND VOLUNTARY EXCLUSION

This provision is applicable to all Federal-aid construction contracts, design-build contracts, subcontracts, lower-tier subcontracts, purchase orders, lease agreements, consultant contracts or any other covered transaction requiring FHWA approval or that is estimated to cost \$25,000 or more – as defined in 2 CFR Parts 180 and 1200.

1. Instructions for Certification – First Tier Participants:

- a. By signing and submitting this proposal, the prospective first tier participant is providing the certification set out below.
- b. The inability of a person to provide the certification set out below will not necessarily result in denial of participation in this covered transaction. The prospective first tier participant shall submit an explanation of why it cannot provide the certification set out below. The certification or explanation will be considered in connection with the department or agency's determination whether to enter into this transaction. However, failure of the prospective first tier participant to furnish a certification or an explanation shall disqualify such a person from participation in this transaction.
- c. The certification in this clause is a material representation of fact upon which reliance was placed when the contracting agency determined to enter into this transaction. If it is later determined that the prospective participant knowingly rendered an erroneous certification, in addition to other remedies available to the Federal Government, the contracting agency may terminate this transaction for cause of default.

d. The prospective first tier participant shall provide immediate written notice to the contracting agency to whom this proposal is submitted if any time the prospective first tier participant learns that its certification was erroneous when submitted or has become erroneous by reason of changed circumstances.

e. The terms "covered transaction," "debarred," "suspended," "ineligible," "participant," "person," "principal," and "voluntarily excluded," as used in this clause, are defined in 2 CFR Parts 180 and 1200. "First Tier Covered Transactions" refers to any covered transaction between a grantee or subgrantee of Federal funds and a participant (such as the prime or general contract). "Lower Tier Covered Transactions" refers to any covered transaction under a First Tier Covered Transaction (such as subcontracts). "First Tier Participant" refers to the participant who has entered into a covered transaction with a grantee or subgrantee of Federal funds (such as the prime or general contractor). "Lower Tier Participant" refers any participant who has entered into a covered transaction with a First Tier Participant or other Lower Tier Participants (such as subcontractors and suppliers).

f. The prospective first tier participant agrees by submitting this proposal that, should the proposed covered transaction be entered into, it shall not knowingly enter into any lower tier covered transaction with a person who is debarred, suspended, declared ineligible, or voluntarily excluded from participation in this covered transaction, unless authorized by the department or agency entering into this transaction.

g. The prospective first tier participant further agrees by submitting this proposal that it will include the clause titled "Certification Regarding Debarment, Suspension, Ineligibility and Voluntary Exclusion-Lower Tier Covered Transactions," provided by the department or contracting agency, entering into this covered transaction, without modification, in all lower tier covered transactions and in all solicitations for lower tier covered transactions exceeding the \$25,000 threshold.

h. A participant in a covered transaction may rely upon a certification of a prospective participant in a lower tier covered transaction that is not debarred, suspended, ineligible, or voluntarily excluded from the covered transaction, unless it knows that the certification is erroneous. A participant is responsible for ensuring that its principals are not suspended, debarred, or otherwise ineligible to participate in covered transactions. To verify the eligibility of its principals, as well as the eligibility of any lower tier prospective participants, each participant may, but is not required to, check the Excluded Parties List System website (<https://www.epls.gov/>), which is compiled by the General Services Administration.

i. Nothing contained in the foregoing shall be construed to require the establishment of a system of records in order to render in good faith the certification required by this clause. The knowledge and information of the prospective participant is not required to exceed that which is normally possessed by a prudent person in the ordinary course of business dealings.

j. Except for transactions authorized under paragraph (f) of these instructions, if a participant in a covered transaction knowingly enters into a lower tier covered transaction with a person who is suspended, debarred, ineligible, or voluntarily excluded from participation in this transaction, in addition to other remedies available to the Federal Government, the department or agency may terminate this transaction for cause or default.

* * * * *

2. Certification Regarding Debarment, Suspension, Ineligibility and Voluntary Exclusion – First Tier Participants:

a. The prospective first tier participant certifies to the best of its knowledge and belief, that it and its principals:

(1) Are not presently debarred, suspended, proposed for debarment, declared ineligible, or voluntarily excluded from participating in covered transactions by any Federal department or agency;

(2) Have not within a three-year period preceding this proposal been convicted of or had a civil judgment rendered against them for commission of fraud or a criminal offense in connection with obtaining, attempting to obtain, or performing a public (Federal, State or local) transaction or contract under a public transaction; violation of Federal or State antitrust statutes or commission of embezzlement, theft, forgery, bribery, falsification or destruction of records, making false statements, or receiving stolen property;

(3) Are not presently indicted for or otherwise criminally or civilly charged by a governmental entity (Federal, State or local) with commission of any of the offenses enumerated in paragraph (a)(2) of this certification; and

(4) Have not within a three-year period preceding this application/proposal had one or more public transactions (Federal, State or local) terminated for cause or default.

b. Where the prospective participant is unable to certify to any of the statements in this certification, such prospective participant shall attach an explanation to this proposal.

2. Instructions for Certification - Lower Tier Participants:

(Applicable to all subcontracts, purchase orders and other lower tier transactions requiring prior FHWA approval or estimated to cost \$25,000 or more - 2 CFR Parts 180 and 1200)

a. By signing and submitting this proposal, the prospective lower tier is providing the certification set out below.

b. The certification in this clause is a material representation of fact upon which reliance was placed when this transaction was entered into. If it is later determined that the prospective lower tier participant knowingly rendered an erroneous certification, in addition to other remedies available to the Federal Government, the department, or agency with which this transaction originated may pursue available remedies, including suspension and/or debarment.

c. The prospective lower tier participant shall provide immediate written notice to the person to which this proposal is submitted if at any time the prospective lower tier participant learns that its certification was erroneous by reason of changed circumstances.

d. The terms "covered transaction," "debarred," "suspended," "ineligible," "participant," "person," "principal," and "voluntarily excluded," as used in this clause, are defined in 2 CFR Parts 180 and 1200. You may contact the person to which this proposal is submitted for assistance in obtaining a copy of those regulations. "First Tier Covered Transactions" refers to any covered transaction between a grantee or subgrantee of Federal funds and a participant (such as the prime or general contract). "Lower Tier Covered Transactions" refers to any covered transaction under a First Tier Covered Transaction (such as subcontracts). "First Tier Participant" refers to the participant who has entered into a covered transaction with a grantee or subgrantee of Federal funds (such as the prime or general contractor). "Lower Tier Participant" refers any participant who has entered into a covered transaction with a First Tier Participant or other Lower Tier Participants (such as subcontractors and suppliers).

e. The prospective lower tier participant agrees by submitting this proposal that, should the proposed covered transaction be entered into, it shall not knowingly enter into any lower tier covered transaction with a person who is debarred, suspended, declared ineligible, or voluntarily excluded from participation in this covered transaction, unless authorized by the department or agency with which this transaction originated.

f. The prospective lower tier participant further agrees by submitting this proposal that it will include this clause titled "Certification Regarding Debarment, Suspension, Ineligibility and Voluntary Exclusion-Lower Tier Covered Transaction," without modification, in all lower tier covered transactions and in all solicitations for lower tier covered transactions exceeding the \$25,000 threshold.

g. A participant in a covered transaction may rely upon a certification of a prospective participant in a lower tier covered transaction that is not debarred, suspended, ineligible, or voluntarily excluded from the covered transaction, unless it knows that the certification is erroneous. A participant is responsible for ensuring that its principals are not suspended, debarred, or otherwise ineligible to participate in covered transactions. To verify the eligibility of its principals, as well as the eligibility of any lower tier prospective participants, each participant may, but is not required to, check the Excluded Parties List System website (<https://www.epls.gov/>), which is compiled by the General Services Administration.

h. Nothing contained in the foregoing shall be construed to require establishment of a system of records in order to render in good faith the certification required by this clause. The knowledge and information of participant is not required to exceed that which is normally possessed by a prudent person in the ordinary course of business dealings.

i. Except for transactions authorized under paragraph e of these instructions, if a participant in a covered transaction knowingly enters into a lower tier covered transaction with a person who is suspended, debarred, ineligible, or voluntarily excluded from participation in this transaction, in addition to other remedies available to the Federal Government, the department or agency with which this transaction originated may pursue available remedies, including suspension and/or debarment.

* * * * *

**Certification Regarding Debarment, Suspension, Ineligibility and Voluntary Exclusion--
Lower Tier Participants:**

1. The prospective lower tier participant certifies, by submission of this proposal, that neither it nor its principals is presently debarred, suspended, proposed for debarment, declared ineligible, or voluntarily excluded from participating in covered transactions by any Federal department or agency.

2. Where the prospective lower tier participant is unable to certify to any of the statements in this certification, such prospective participant shall attach an explanation to this proposal.

XI. CERTIFICATION REGARDING USE OF CONTRACT FUNDS FOR LOBBYING

This provision is applicable to all Federal-aid construction contracts and to all related subcontracts which exceed \$100,000 (49 CFR 20).

1. The prospective participant certifies, by signing and submitting this bid or proposal, to the best of his or her knowledge and belief, that:

a. No Federal appropriated funds have been paid or will be paid, by or on behalf of the undersigned, to any person for influencing or attempting to influence an officer or employee of any Federal agency, a Member of Congress, an officer or employee of Congress, or an employee of a Member of Congress in connection with the awarding of any Federal contract, the making of any Federal grant, the making of any Federal loan, the entering into of any cooperative agreement, and the extension, continuation, renewal, amendment, or modification of any Federal contract, grant, loan, or cooperative agreement.

b. If any funds other than Federal appropriated funds have been paid or will be paid to any person for influencing or attempting to influence an officer or employee of any Federal agency, a Member of Congress, an officer or employee of Congress, or an employee of a Member of Congress in connection with this Federal contract, grant, loan, or cooperative agreement, the undersigned shall complete and submit Standard Form-LLL, "Disclosure Form to Report Lobbying," in accordance with its instructions.

2. This certification is a material representation of fact upon which reliance was placed when this transaction was made or entered into. Submission of this certification is a prerequisite for making or entering into this transaction imposed by 31 U.S.C. 1352. Any person who fails to file the required certification shall be subject to a civil penalty of not less than \$10,000 and not more than \$100,000 for each such failure.

3. The prospective participant also agrees by submitting its bid or proposal that the participant shall require that the language of this certification be included in all lower tier subcontracts, which exceed \$100,000 and that all such recipients shall certify and disclose accordingly.

**ATTACHMENT A - EMPLOYMENT AND MATERIALS PREFERENCE FOR
APPALACHIAN DEVELOPMENT HIGHWAY SYSTEM OR APPALACHIAN LOCAL
ACCESS ROAD CONTRACTS**

This provision is applicable to all Federal-aid projects funded under the Appalachian Regional Development Act of 1965.

1. During the performance of this contract, the contractor undertaking to do work which is, or reasonably may be, done as on-site work, shall give preference to qualified persons who regularly reside in the labor area as designated by the DOL wherein the contract work is situated, or the subregion, or the Appalachian counties of the State wherein the contract work is situated, except:

a. To the extent that qualified persons regularly residing in the area are not available.

b. For the reasonable needs of the contractor to employ supervisory or specially experienced personnel necessary to assure an efficient execution of the contract work.

c. For the obligation of the contractor to offer employment to present or former employees as the result of a lawful collective bargaining contract, provided that the number of nonresident persons employed under this subparagraph (1c) shall not exceed 20 percent of the total number of employees employed by the contractor on the contract work, except as provided in subparagraph (4) below.

2. The contractor shall place a job order with the State Employment Service indicating (a) the classifications of the laborers, mechanics and other employees required to perform the contract work, (b) the number of employees required in each classification, (c) the date on which the participant estimates such employees will be required, and (d) any other pertinent information required by the State Employment Service to complete the job order form. The job order may be placed with the State Employment Service in writing or by telephone. If during the course of the contract work, the information submitted by the contractor in the original job order is substantially modified, the participant shall promptly notify the State Employment Service.

3. The contractor shall give full consideration to all qualified job applicants referred to him by the State Employment Service. The contractor is not required to grant employment to any job applicants who, in his opinion, are not qualified to perform the classification of work required.

4. If, within one week following the placing of a job order by the contractor with the State Employment Service, the State Employment Service is unable to refer any qualified job applicants to the contractor, or less than the number requested, the State Employment Service will forward a certificate to the contractor indicating the unavailability of applicants. Such certificate shall be made a part of the contractor's permanent project records. Upon receipt of this certificate, the contractor may employ persons who do not normally reside in the labor area to fill positions covered by the certificate, notwithstanding the provisions of subparagraph (1c) above.

5. The provisions of 23 CFR 633.207(e) allow the contracting agency to provide a contractual preference for the use of mineral resource materials native to the Appalachian region.

6. The contractor shall include the provisions of Sections 1 through 4 of this Attachment A in every subcontract for work which is, or reasonably may be, done as on-site work.

End of FHWA 1273

The United States Department of Transportation (USDOT)

FHWA STANDARD TITLE VI/NONDISCRIMINATION ASSURANCES

DOT Order No. 1050.2A

The Maine Department of Transportation (herein referred to as the "Recipient"), **HEREBY AGREES THAT**, as a condition to receiving any Federal financial assistance from the U.S. Department of Transportation (DOT), through The Federal Highway Administration (FHWA), is subject to and will comply with the following:

Statutory/Regulatory Authorities

- Title VI of the Civil Rights Act of 1964 (42 U.S.C. § 2000d *et seq.*, 78 stat. 252), (prohibits discrimination on the basis of race, color, national origin);
- 49 C.F.R. Part 21 (entitled *Nondiscrimination In Federally-Assisted Programs Of The Department Of Transportation—Effectuation Of Title VI Of The Civil Rights Act Of 1964*);
- 28 C.F.R. section 50.3 (U.S. Department of Justice Guidelines for Enforcement of Title VI of the Civil Rights Act of 1964);

FHWA may include additional Statutory/Regulatory Authorities here.

The preceding statutory and regulatory cites hereinafter are referred to as the "Acts" and "Regulations," respectively.

General Assurances

In accordance with the Acts, the Regulations, and other pertinent directives, circulars, policy, memoranda, and/or guidance, the Recipient hereby gives assurance that it will promptly take any measures necessary to ensure that:

No person in the United States shall, on the grounds of race, color, or national origin, be excluded from participation in, be denied the benefits of, or be otherwise subjected to discrimination under any program or activity," for which the Recipient receives Federal financial assistance from DOT, including FHWA..

The Civil Rights Restoration Act of 1987 clarified the original intent of Congress, with respect to Title VI and other Nondiscrimination requirements (The Age Discrimination Act of 1975, and Section 504 of the Rehabilitation Act of 1973), by restoring the broad, institutional-wide scope and coverage of these nondiscrimination statutes and requirements to include all programs and activities of the Recipient, so long as any portion of the program is Federally assisted.

FHWA may include additional General Assurances in this section, or reference an addendum here.

Specific Assurances

More specifically, and without limiting the above general Assurance, the Recipient agrees with and gives the following Assurances with respect to its federally assisted programs:

1. The Recipient agrees that each "activity," "facility," or "program," as defined in §§ 21.23 (b) and 21.23 (e) of 49 C.F.R. § 21 will be (with regard to an "activity") facilitated, or will be (with regard to a "facility") operated, or will be (with regard to a "program") conducted in compliance with all requirements imposed by, or pursuant to the Acts and the Regulations.
2. The Recipient will insert the following notification in all solicitations for bids, Requests For Proposals for work, or material subject to the Acts and the Regulations made in connection with all Federal Highway Programs and, in adapted form, in all proposals for negotiated agreements regardless of funding source:

The (Agency), in accordance with the provisions of Title VI of the Civil Rights Act of 1964 (78 Stat. 252, 42 U.S.C. §§ 2000d to 2000d-4) and the Regulations, hereby notifies all bidders that it will affirmatively insure that any contract entered into pursuant to this advertisement, disadvantaged business enterprises will be afforded full opportunity to submit bids in response to this invitation and will not be discriminated against on the grounds of race, color, or national origin in consideration for an award.

3. The Recipient will insert the clauses of Appendix A and E of this Assurance in every contract or agreement subject to the Acts and the Regulations.
4. The Recipient will insert the clauses of Appendix B of this Assurance, as a covenant running with the land, in any deed from the United States effecting or recording a transfer of real property, structures, use, or improvements thereon or interest therein to a Recipient.
5. That where the Recipient receives Federal financial assistance to construct a facility, or part of a facility, the Assurance will extend to the entire facility and facilities operated in connection therewith.
6. That where the Recipient receives Federal financial assistance in the form, or for the acquisition of real property or an interest in real property, the Assurance will extend to rights to space on, over, or under such property.
7. That the Recipient will include the clauses set forth in Appendix C and Appendix D of this Assurance, as a covenant running with the land, in any future deeds, leases, licenses, permits, or similar instruments entered into by the Recipient with other parties:
 - a. for the subsequent transfer of real property acquired or improved under the applicable activity, project, or program; and
 - b. for the construction or use of, or access to, space on, over, or under real property acquired or improved under the applicable activity, project, or program.
8. That this Assurance obligates the Recipient for the period during which Federal financial assistance is extended to the program, except where the Federal financial assistance is to provide, or is in the form of, personal property, or real property, or interest therein, or structures or improvements thereon, in which case the Assurance obligates the Recipient, or any transferee for the longer of the following periods:

- a. the period during which the property is used for a purpose for which the Federal financial assistance is extended, or for another purpose involving the provision of similar services or benefits; or
 - b. the period during which the Recipient retains ownership or possession of the property.
9. The Recipient will provide for such methods of administration for the program as are found by the Secretary of Transportation or the official to whom he/she delegates specific authority to give reasonable guarantee that it, other recipients, sub-recipients, sub-grantees, contractors, subcontractors, consultants, transferees, successors in interest, and other participants of Federal financial assistance under such program will comply with all requirements imposed or pursuant to the Acts, the Regulations, and this Assurance.
10. The Recipient agrees that the United States has a right to seek judicial enforcement with regard to any matter arising under the Acts, the Regulations, and this Assurance.

FHWA may include additional Specific Assurances in this section.

By signing this ASSURANCE, Maine Department of Transportation also agrees to comply (and require any subrecipients, sub-grantees, contractors, successors, transferees, and/or assignees to comply) with all applicable provisions governing the FHWA access to records, accounts, documents, information, facilities, and staff. You also recognize that you must comply with any program or compliance reviews, and/or complaint investigations conducted by FHWA. You must keep records, reports, and submit the material for review upon request to FHWA, or their designees in a timely, complete, and accurate way. Additionally, you must comply with all other reporting, data collection, and evaluation requirements, as prescribed by law or detailed in program guidance.

Maine Department of Transportation gives this ASSURANCE in consideration of and for obtaining any Federal grants, loans, contracts, agreements, property, and/or discounts, or other Federal-aid and Federal financial assistance extended after the date hereof to the recipients by the U.S. Department of Transportation. This ASSURANCE is binding on Maine Department of Transportation, other recipients, sub-recipients, sub-grantees, contractors, subcontractors and their subcontractors', transferees, successors in interest, and any other participants in it programs. . The person(s) signing below is authorized to sign this ASSURANCE on behalf of the Recipient.

Name of Recipient: Maine Department of Transportation



David Bernhardt, Commissioner

DATED: 9/18/14

APPENDIX A

During the performance of this contract, the contractor, for itself, its assignees, and successors in interest (hereinafter referred to as the “contractor”) agrees as follows:

1. **Compliance with Regulations:** The contractor (hereinafter includes consultants) will comply with the Acts and the Regulations relative to Nondiscrimination in Federally-assisted programs of the U.S. Department of Transportation, **Federal Highway Administration**, as they may be amended from time to time, which are herein incorporated by reference and made a part of this contract.
2. **Nondiscrimination:** The contractor, with regard to the work performed by it during the contract, will not discriminate on the grounds of race, color, or national origin in the selection and retention of subcontractors, including procurements of materials and leases of equipment. The contractor will not participate directly or indirectly in the discrimination prohibited by the Acts and the Regulations as set forth in Appendix E, including employment practices when the contract covers any activity, project, or program set forth in Appendix B of 49 CFR Part 21.
3. **Solicitations for Subcontracts, Including Procurements of Materials and Equipment:** In all solicitations, either by competitive bidding, or negotiation made by the contractor for work to be performed under a subcontract, including procurements of materials, or leases of equipment, each potential subcontractor or supplier will be notified by the contractor of the contractor’s obligations under this contract and the Acts and the Regulations relative to Non-discrimination on the grounds of race, color, or national origin.
4. **Information and Reports:** The contractor will provide all information and reports required by the Acts, the Regulations and directives issued pursuant thereto and will permit access to its books, records, accounts, other sources of information, and its facilities as may be determined by the Recipient or the **Federal Highway Administration**, to be pertinent to ascertain compliance with such Acts, Regulations, and instructions. Where any information required of a contractor is in the exclusive possession of another who fails or refuses to furnish the information, the contractor will so certify to the Recipient or the **Federal Highway Administration**, as appropriate, and will set forth what efforts it has made to obtain the information.
5. **Sanctions for Noncompliance:** In the event of a contractor’s noncompliance with the Non-discrimination provisions of this contract, the Recipient will impose such contract sanctions as it or the **Federal Highway Administration**, may determine to be appropriate, including, but not limited to:
 - a. withholding payments to the contractor under the contract until the contractor complies; and/or
 - b. cancelling, terminating, or suspending a contract, in whole or in part.

Incorporation of Provisions: The contractor will include the provisions of paragraphs one through six in every subcontract, including procurements of materials and leases of equipment, unless exempt by the Acts, the Regulations and directives issued pursuant thereto. The contractor will take action with respect to any subcontract or procurement as the Recipient or the **Federal Highway Administration**, may direct as a means of enforcing such provisions including sanctions for noncompliance. Provided, that if the contractor becomes involved in, or is threatened with litigation by a subcontractor, or supplier because of such direction, the contractor may request the Recipient to enter into any litigation to protect the interests of the Recipient. In addition, the contractor may request the United States to enter into the litigation to protect the interests of the United States.

(APPENDIX C TO MAINEDOT TITLE VI ASSURANCE)

FEDERAL HIGHWAY ADMINISTRATION ASSISTED PROGRAMS

The following clauses shall be included in all deeds, licenses, leases, permits, or similar instruments entered into

by the Maine Department of Transportation pursuant to the provisions of Assurance 7(a).

The (grantee, licensee, lessee, permittee, etc., as appropriate) for herself/himself, his/her heirs, personal representatives, successors in interest, and assigns, as a part of the consideration hereof, does hereby covenant and agree [in the case of deeds and leases add "as a covenant running with the land"] that in the event facilities are constructed, maintained, or otherwise operated on the said property described in this (deed, license, lease, permit, etc.) for a purpose for which a Department of Transportation program or activity is extended or for another purpose involving the provision of similar services or benefits, the (grantee, licensee lessee, permittee, etc.) shall maintain and operate such facilities and services in compliance with all other requirements imposed pursuant to Title 49, Code of Federal Regulations, Department of Transportation, Subtitle A, Office of the Secretary, Part 21, Nondiscrimination of Federally-Assisted Programs of the Department of Transportation - Effectuation of Title VI of the Civil Rights Act of 1964, and as said Regulations may be amended.

[Include in licenses, leases, permits, etc.]*

That in the event of breach of any of the above nondiscrimination covenants, Maine Department of Transportation shall have the right to terminate the [license, lease, permit, etc.] and to re-enter and repossess said land and the facilities thereon, and hold the same as if said [licenses, lease, permit, etc.] had never been made or issued.

[Include in deeds]*

That in the event of breach of any of the above nondiscrimination covenants, Maine Department of Transportation shall have the right to re-enter said lands and facilities thereon, and the above described lands and facilities shall thereupon revert to and vest in and become the absolute property of Maine Department of Transportation and its assigns.

The following shall be included in all deeds, licenses, leases, permits, or similar agreements entered into by Maine Department of Transportation pursuant to the provisions of Assurance 7(b).

The (grantee, licensee, lessee, permittee, etc., as appropriate) for herself/himself, his/her personal representatives, successors in interest, and assigns, as a part of the consideration hereof, does hereby covenant and agree (in case of deeds, and leases add "as a covenant running with the land") that (1) no person on the grounds of race, color, or national origin shall be excluded from participation in, be denied the benefits of, or be otherwise subjected to discrimination in the use of said facilities, (2) that in the construction of any improvements on, over or under such land and the furnishing services thereon, no person on the grounds of race, color, or national origin shall be excluded from the participation in, be denied the benefits of, or be otherwise subjected to discrimination, and (3) that the (grantee, licensee, lessee, permittee, etc.) shall use the premises in compliance with all other requirements imposed by or pursuant to Title 49, Code of Federal Regulations, Department of Transportation, Subtitle A, Office of the Secretary, Part 21, Nondiscrimination in Federally-Assisted Programs of the Department of Transportation - Effectuation of Title VI of the Civil Rights Act of 1964, and as said Regulations may be amended.

[Include in licenses, leases, permits, etc.]*

That in the event of breach of any of the above nondiscrimination covenants, Maine Department of Transportation shall have the right to terminate the [license, lease, permit, etc.] and to re-enter and repossess said land and the facilities thereon, and hold the same as if said [license, lease, permit, etc.] had never been made or issued.

[Include in deeds]*

That in the event of breach of any of the above nondiscrimination covenants, Maine Department of Transportation shall have the right to re-enter said land and facilities thereon, and the above described lands and facilities shall thereupon revert to and vest in and become the absolute property of Maine Department of Transportation and its assigns.

* Reverter clause and related language to be used only when it is determined that such a clause is necessary in order to effectuate the purpose of Title VI of the Civil Rights Act of 1964.

APPENDIX D

CLAUSES FOR CONSTRUCTION/USE/ACCESS TO REAL PROPERTY ACQUIRED UNDER THE ACTIVITY, FACILITY OR PROGRAM

The following clauses will be included in deeds, licenses, permits, or similar instruments/agreements entered into by The Maine Department of Transportation pursuant to the provisions of Assurance 7(b):

- A. The (grantee, licensee, permittee, etc., as appropriate) for himself/herself, his/her heirs, personal representatives, successors in interest, and assigns, as a part of the consideration hereof, does hereby covenant and agree (in the case of deeds and leases add, “as a covenant running with the land”) that (1) no person on the ground of race, color, or national origin, will be excluded from participation in, denied the benefits of, or be otherwise subjected to discrimination in the use of said facilities, (2) that in the construction of any improvements on, over, or under such land, and the furnishing of services thereon, no person on the ground of race, color, or national origin, will be excluded from participation in, denied the benefits of, or otherwise be subjected to discriminations, (3) that the (grantee, licensees, lessee, permittee, etc.) will use the premises in compliance with all other requirements imposed by or pursuant to the Acts and Regulations, as amended, set forth in this Assurance.
- B. With respect to (licenses, leases, permits, etc.), in the event of breach of any of the above Non-discrimination covenants, (**The Maine Department of Transportation**) will have the right to terminate the (license, permit, etc., as appropriate) and to enter or re-enter and repossess said land and the facilities thereon, and hold the same as if said (license, permit, etc., as appropriate) had never been made or issued.*
- C. With respect to deeds, in the event of breach of any of the above Non-discrimination covenants, (**The Maine Department of Transportation**) will there upon revert to and vest in and become the absolute property of (**The Maine Department of Transportation**) and its assigns.*

(*Reverter clause and related language to be used only when it is determined that such a clause is necessary to make clear the purpose of Title VI.)

APPENDIX E

During the performance of this contract, the contractor, for itself, its assignees, and successors in interest (hereinafter referred to as the “contractor”) agrees to comply with the following non-discrimination statutes and authorities; including but not limited to:

Pertinent Non-Discrimination Authorities:

- Title VI of the Civil Rights Act of 1964 (42 U.S.C. §2000d *et seq.*, 78 stat. 252), (prohibits discrimination on the basis of race, color, national origin); and 49 CFR Part 21.
- The Uniform Relocation Assistance and Real Property Acquisition Policies Act of 1970, (42 U.S.C. §4601), (prohibits unfair treatment of persons displaced or whose property has been acquired because of Federal or Federal-aid programs and projects);
- Federal-Aid Highway Act of 1973, (23 U.S.C. §324 *et seq.*), (prohibits discrimination on the basis of sex);
- Section 504 of the Rehabilitation Act of 1973, (29 U.S.C. §794 *et seq.*), as amended, (prohibits discrimination on the basis of disability); and 49 CFR Part 27;
- The Age Discrimination Act of 1975, as amended, (42 U.S.C. §6101 *et seq.*), (prohibits discrimination on the basis of age);
- Airport and Airway Improvement Act of 1982, (49 U.S.C. §471, Section 47123), as amended, (prohibits discrimination based on race, creed, color, national origin, or sex);
- The Civil Rights Restoration Act of 1987, (PL 100-209), (Broadened the scope, coverage and applicability of Title VI of the Civil Rights Act of 1964, The Age Discrimination Act of 1975 and Section 504 of the Rehabilitation Act of 1973, by expanding the definition of the terms “programs or activities” to include all of the programs or activities of the Federal-aid recipients, sub-recipients and contractors, whether such programs or activities are Federally funded or not);
- Titles II and III of the Americans with Disabilities Act, which prohibit discrimination on the basis of disability in the operation of public entities, public and private transportation systems, places of public accommodation, and certain testing entities (42 U.S.C. §§12131-12189) as implemented by Department of Transportation regulations at 49 C.F.R. Parts 37 and 38;
- The Federal Aviation Administration’s Non-discrimination statute (49 U.S.C. §47123) (prohibits discrimination on the basis of race, color, national origin and sex);
- Executive Order 12898, Federal Actions to Address Environmental Justice in Minority Populations and Low-Income Populations, which ensures discrimination against minority populations by discouraging programs, policies, and activities with disproportionately high and adverse human health or environmental effects on minority and low-income populations;
- Executive Order 13166, Improving Access to Services for Persons with Limited English Proficiency, and resulting agency guidance, national origin discrimination includes discrimination because of limited English proficiency (LEP). To ensure compliance with Title VI, you must take reasonable steps to ensure that LEP persons have meaningful access to your programs (70 Fed. Reg. at 74087 to 74100);
- Title IX of the Education Amendments of 1972, as amended, which prohibits you from discriminating of sex in education programs or activities (20 U.S.C. 1681 *et seq.*).



Environmental Summary Sheet

WIN: 24923.00

Date Submitted: 2/5/2021

Towns/Road: Caribou-New Sweden, Route 161

ENV Team Leader: Audie Arbo

ENV Field Contact: Jamey Reitmeyer

NEPA Complete: Programmatic Categorical Exclusion per 23 CFR §771.117(c)(26) on 2/5/2021

Section 106
PA-B

Section 4(f) and 6(f)
Complete- No use
Complete-No takes

Maine Department of Inland Fisheries and Wildlife Essential Habitat
Not Applicable Timing Window: Not Applicable

Section 7
No Effect based on scope.

Essential Fish Habitat
Not Applicable based on PIS

Maine Department of Conservation/Public Lands, Submerged Land Lease
Not Applicable

Maine Land Use Regulation Commission
Not Applicable

**Applicable Standards and Permits are included with the contract*

Maine Department of Environmental Protection
Not Applicable-No work in jurisdictional resources.

**Applicable Standards and Permits are included with the contract*

Army Corps of Engineers, Section 10 of the Rivers and Harbors Act and Section 404 of the Clean Water Act.
Not Applicable-No work in jurisdictional resources.

**Applicable Standards and Permits are included with the contract*

Stormwater Review
No quality treatment required based on scope

<input checked="" type="checkbox"/> Special Provisions Required		
Special Provision 105-Timing of Work Restriction	N/A <input checked="" type="checkbox"/>	Applicable <input type="checkbox"/>
Special Provision 656-Minor Soil Disturbance	N/A <input checked="" type="checkbox"/>	Applicable <input type="checkbox"/>
Standard Specification 656-Erosion Control Plan	N/A <input type="checkbox"/>	Applicable <input checked="" type="checkbox"/>
Special Provision 203-Dredge Spec	N/A <input checked="" type="checkbox"/>	Applicable <input type="checkbox"/>
General Note for Hazardous Waste	N/A <input checked="" type="checkbox"/>	Applicable <input type="checkbox"/>
Special Provision 203-Hazardous Waste	N/A <input checked="" type="checkbox"/>	Applicable <input type="checkbox"/>

**All permits and approvals based on plans/scope as provided via email to ENV: 10/5/2020*