

Updated 12/13/2021

FEDERAL PROJECT

BIDDING INSTRUCTIONS

FOR ALL PROJECTS:

1. Use pen and ink to complete all paper Bids.
2. As a minimum, the following must be received prior to the time of Bid opening:

For a Paper Bid:

- a) a copy of the Notice to Contractors, b) the completed Acknowledgement of Bid Amendments form, c) the completed Schedule of Items, d) two copies of the completed and signed Contract Offer, Agreement & Award form, e) a Bid Guaranty, (if required), and f) any other certifications or Bid requirements listed in the Bid Documents as due by Bid opening.

For an Electronic Bid:

NOTE: Not all projects accept Electronic Bids. Please review the Notice to Contractors and see if it specifically states that Electronic Bids will be accepted.

- a) a completed Bid using Expedite® software and submitted via the Bid Express™ web-based service, b) an electronic Bid Guaranty (if required) or a faxed copy of a Bid Bond (with original to be delivered within 72 hours), and c) any other Certifications or Bid requirements listed in the Bid Documents as due by Bid opening.
3. Include prices for all items in the Schedule of Items (excluding non-selected alternates).
4. Bid Guaranty acceptable forms are:
 - a) a properly completed and signed Bid Bond on the Department's prescribed form (or on a form that does not contain any significant variations from the Department's form as determined by the Department) for 5% of the Bid Amount or
 - b) an Official Bank Check, Cashier's Check, Certified Check, U.S. Postal Money Order or Negotiable Certificate of Deposit in the amount stated in the Notice to Contractors or
 - c) an electronic bid bond submitted with an electronic bid.
5. If a paper Bid is to be sent, "FedEx First Overnight" delivery is suggested as the package is delivered directly to the DOT Headquarters Building located at 16 Child Street in Augusta. Other means, such as U.S. Postal Service's Express Mail has proven not to be reliable.

IN ADDITION, FOR FEDERAL AID PROJECTS:

6. Complete the DBE Proposed Utilization form, and submit with your bid. If you are submitting your bid electronically, you must FAX the form to (207) 624-3431. This is a curable defect.

*If you need further information regarding Bid preparation, call the DOT
Contracts Section at (207) 624-3410.*

*For complete bidding requirements, refer to Section 102 of the Maine Department
of Transportation, Standard Specifications, March 2020 Edition.*

NOTICE

The Maine Department of Transportation is attempting to improve the way Bid Amendments/Addendums are handled and allow for an electronic downloading of bid packages from our website, while continuing to maintain an optional plan holders list.

Prospective bidders, subcontractors or suppliers who wish to download a copy of the bid package and receive a courtesy notification of project specific bid amendments must fill out the on-line plan holder registration form and provide an email address to the MDOT Contracts mailbox at: MDOT.contracts@maine.gov. Each bid package will require a separate request.

Additionally, interested parties will be responsible for reviewing and retrieving the Bid Amendments from our web site, and acknowledging receipt and incorporating those Bid Amendments in their bids using the Acknowledgement of Bid Amendment Form.

The downloading of bid packages from the MDOT website is not the same as providing an electronic bid to the Department. Electronic bids must be submitted via <http://www.BIDX.com>. For information on electronic bidding contact Rebecca Snowden at rebecca.snowden@maine.gov or Diane Barnes at diane.barnes@maine.gov.

NOTICE

For security and other reasons, all Bid Packages which are mailed, shall be provided in double (one envelope inside the other) envelopes. The *Inner Envelope* shall have the following information provided on it:

Bid Enclosed - Do Not Open

PIN:

Town:

Date of Bid Opening:

Name of Contractor with mailing address and telephone number:

In Addition to the usual address information, the *Outer Envelope* should have written or typed on it:

Double Envelope: Bid Enclosed

PIN:

Town:

Date of Bid Opening:

Name of Contractor:

This should not be much of a change for those of you who use Federal Express or similar services.

Hand-carried Bids may be in one envelope as before, and should be marked with the following information:

Bid Enclosed: Do Not Open

PIN:

Town:

Name of Contractor:

October 16, 2001

STATE OF MAINE DEPARTMENT OF TRANSPORTATION
Bid Guaranty-Bid Bond Form

KNOW ALL MEN BY THESE PRESENTS THAT _____

_____, of the City/Town of _____ and State of _____

as Principal, and _____ as Surety, a

Corporation duly organized under the laws of the State of _____ and having a usual place of

Business in _____ and hereby held and firmly bound unto the Treasurer of

the State of Maine in the sum of _____ for payment which Principal and Surety bind

themselves, their heirs, executors, administrators, successors and assigns, jointly and severally.

The condition of this obligation is that the Principal has submitted to the Maine Department of

Transportation, hereafter Department, a certain bid, attached hereto and incorporated as a

part herein, to enter into a written contract for the construction of _____

_____ and if the Department shall accept said bid

and the Principal shall execute and deliver a contract in the form attached hereto (properly

completed in accordance with said bid) and shall furnish bonds for this faithful performance of

said contract, and for the payment of all persons performing labor or furnishing material in

connection therewith, and shall in all other respects perform the agreement created by the

acceptance of said bid, then this obligation shall be null and void; otherwise it shall remain in full

force, and effect.

Signed and sealed this _____ day of _____ 20_____

WITNESS:

WITNESS

PRINCIPAL:

By _____

By: _____

By: _____

SURETY:

By _____

By: _____

Name of Local Agency: _____

NOTICE

Bidders:

Please use the attached “Request for Information” form when submitting questions concerning specific Contracts that have been advertised for Bid, include additional numbered pages as required. RFI’s may be faxed to 207-624-3431, submitted electronically through the Departments web page of advertised projects by selecting the RFI tab on the project details page or via e-mail to RFI-Contracts.MDOT@maine.gov.

These are the only allowable mechanisms for answering Project specific questions. Maine DOT will not be bound to any answers to Project specific questions received during the Bidding phase through other processes.

When submitting RFIs by Email please follow the same guidelines as stated on the “Request for Information” form and include the word “RFI” along with the Project name and Identification number in the subject line.

NOTICE

Disadvantaged Business Enterprise Proposed Utilization

The Apparent Low Bidder shall submit the Disadvantaged Business Enterprise Proposed Utilization form with their bid. This is a curable bid defect.

The Contractor's Disadvantaged Business Enterprise Proposed Utilization Plan form contains additional information that is required by USDOT.

The Contractor's Disadvantaged Business Enterprise Proposed Utilization Plan form should be used.

A copy of the new Contractor's Disadvantaged Business Enterprise Proposed Utilization Plan and instructions for completing it are attached.

Note: Questions about DBE firms, or to obtain a printed copy of the DBE Directory, contact The Office of Civil Rights at (207) 624-3066.

MDOT's DBE Directory of Certified firms can also be obtained at <https://www.maine.gov/mdot/civilrights/dbe/>

INSTRUCTIONS FOR PREPARING THE MaineDOT CONTRACTOR'S DBE/SUBCONTRACTOR UTILIZATION FORM

The Contractor Shall Extend equal opportunity to MaineDOT certified DBE firms (as listed in MaineDOT's DBE Directory of Certified Businesses) in the selection and utilization of Subcontractors and Suppliers.

SPECIFIC INSTRUCTIONS FOR COMPLETING THE FORM:

Insert Contractor name, the name of the person(s) preparing the form, and that person(s) telephone, fax number and e-mail address.

Calculate and provide percentage of your bid that will be allocated to DBE firms, Federal Project Identification Number, and location of the Project work.

In the columns, name each subcontractor, DBE and non-DBE firm to be used, provide the Unit/Item cost of the work/product to be provided by the subcontractor, give a brief description and the dollar value of the work.

Revised 1/12

DBE GOAL NOTICE FFY 2022-2024
Maine Department of Transportation
Disadvantaged Business Enterprise Program

Notice is hereby given that in accordance with US DOT regulation 49 CFR Part 26, the Maine Department of Transportation (MaineDOT) has established a Disadvantaged Business Enterprise Program (DBE) for disadvantaged business participation in the federal-aid highway and bridge construction programs; MaineDOT contracts covered by the program include consulting, construction, supplies, manufacturing, and service contracts.

For FFY 2022-24 (October 1, 2021 through September 30, 2024) MaineDOT has established an annual DBE participation goal of **1.97%** to be achieved through race/gender neutral means. This goal has been approved by the Federal Highway Administration and remains in effect through September 30, 2024. MaineDOT must meet this goal each federal fiscal year. If the goal is not met, MaineDOT must provide a justification for not meeting the goal and provide a plan to ensure the goal is met, which may include contract goals on certain projects that contractors will be required to meet.

MaineDOT asks all contractors, consultants and subcontractors to seek certified DBE firms for projects and to work to meet the determined 1.97% goal without the need to impose contract goals. DBE firms are listed on the MaineDOT website at:

<http://www.maine.gov/mdot/disadvantaged-business-enterprises/pdf/directory.pdf>

Interested parties may view MaineDOT's DBE goal setting methodology, also posted on this website. If you have questions regarding this goal or the DBE program you may contact Sherry Tompkins at the Maine Department of Transportation, Civil Rights Office by telephone at (207) 624-3066 or by e-mail at: sherry.tompkins@maine.gov

**MaineDOT CONTRACTOR'S DBE/SUBCONTRACTOR
PROPOSED UTILIZATION FORM**

All Bidders must furnish this form with their bid on Bid Opening day

Contractor: _____ Telephone: _____ Ext _____

Contact Person: _____ Fax: _____

E-mail: _____

BID DATE: _____

FEDERAL PROJECT PIN # _____ PROJECT LOCATION: _____

TOTAL ANTICIPATED DBE _____% PARTICIPATION FOR THIS CONTRACT

W B E	D B E	Non DBE	Firm Name	Item Number & Description of Work	Quantity	Cost Per Unit/Item	Anticipated \$ Value
Subcontractor Total >							
DBE Total >							

**NOTE: THIS INFORMATION IS USED TO TRACK AND REPORT ANTICIPATED DBE PARTICIPATION IN ALL
FEDERALLY FUNDED MAINE DOT CONTRACTS. THE ANTICIPATED DBE AMOUNT IS VOLUNTARY AND WILL
NOT BECOME A PART OF THE CONTRACTUAL TERMS.**

Equal Opportunity Use:

Form received: ___/___/___ Verified by: _____

FHWA FTA FAA

**For a complete list of certified firms and company designation (WBE/DBE) go to
<http://www.maine.gov/mdot/civilrights/>**

Maine Department of Transportation Civil Rights Office

Directory of Certified Disadvantaged Business Enterprises

Listing can be found at:

<https://www.maine.gov/mdot/civilrights/dbe/>

For additional information and guidance contact:

Civil Rights Office at (207) 624-3066

It is the responsibility of the Contractor to access the DBE Directory at this site in order to have the most current listing.

Vendor Registration

Prospective Bidders must register as a vendor with the Department of Administrative & Financial Services if the vendor is awarded a contract. Vendors will not be able to receive payment without first being registered. Vendors/Contractors will find information and register through the following link –

<http://www.maine.gov/purchases/venbid/index.shtml>

NOTICE

(COVID-19 Pandemic)

The Department considers the COVID-19 Pandemic an Uncontrollable Event as defined in Section 101.2 of the Department's Standard Specifications.

Accordingly, any documented delay to the project's Critical Path due to COVID-19 related issues, such as impacted workforce, subcontracts, or material supply, will be considered an Excusable Delay as defined in Section 109.5(A)(3) of the Department's Supplemental Specifications.

As an Excusable Delay, the Contractor is entitled to an extension of time provided that other associated notification, documentation, and procedural requirements set forth in the Contract are met.

NOTICE

All bids for Federal Projects **shall** be accompanied by the DBE Proposed Utilization form. If you are submitting an electronic bid, the DBE Utilization Form may be faxed to 207-624-3431. Failure to submit the form with the bid will be considered a curable defect.

**STATE OF MAINE DEPARTMENT OF TRANSPORTATION
NOTICE TO CONTRACTORS**

Sealed Bids addressed to the Maine Department of Transportation, Augusta, Maine 04333 and endorsed on the wrapper "Bids for **Large Culvert Rehabilitation** in the town of **Union**" will be received from contractors at the Reception Desk, MaineDOT Building, Capitol Street, Augusta, Maine, until 11:00 o'clock A.M. (prevailing time) on April 6, 2022 and at that time and place, publicly opened and read. Bids will be accepted from all bidders. The lowest responsive bidder must have completed, or successfully complete, a **Highway Construction prequalification**, or project specific prequalification to be considered for the award of this contract. We now accept electronic bids for bid packages posted on the **bidx.com** website. Electronic bids do not have to be accompanied by paper bids. **Please note: The Department will accept a facsimile of the bid bond; however, the original bid bond must then be received at the MDOT Contract Section within 72 hours of the bid opening.** Until further notice, dual bids (one paper, one electronic) will be accepted, with the paper copy taking precedence.

Description: Maine Federal Aid Project No. 2423700 WIN. 024237.00

Location: In Knox County, project is located On Rte. 17, approx. 06 mi. easterly of Town House Rd.

Outline of Work: Large Culvert Rehabilitation and other incidental work.

For general information regarding Bidding and Contracting procedures, contact George Macdougall at (207) 624-3410. Our webpage at <http://www.maine.gov/mdot/contractors/> contains a copy of the Schedule of Items, Plan Holders List, written portions of bid amendments, drawings, bid results and an electronic form for RFI submittal. For Project-specific information fax all questions to **Project Manager** at Doug Coombs (207) 624-3431, use electronic RFI form or email questions to RFI-Contracts.MDOT@maine.gov, project name and identification number should be in the subject line. Questions received after 12:00 noon of Monday (or if that Monday is a state holiday, Friday) prior to bid date will not be answered. Bidders shall not contact any other Departmental staff for clarification of Contract provisions, and the Department will not be responsible for any interpretations so obtained. TTY users call Maine Relay 711.

Plans, specifications and bid forms may be seen at the MaineDOT Building in Augusta, Maine. They may be purchased from the Department between the hours of 8:00 a.m. to 4:30 p.m. by cash, credit card (Visa/Mastercard) or check payable to Treasurer, State of Maine sent to Maine Department of Transportation, Attn.: Mailroom, 16 State House Station, Augusta, Maine 04333-0016. They also may be purchased by telephone at (207) 624-3536 between the hours of 8:00 a.m. to 4:30 p.m. Full size plans **\$9.00 (\$12.50 by mail)**. Half size plans **\$4.50 (\$6.75 by mail)**, Bid Book \$10 (\$13 by mail), Single Sheets \$2, payment in advance, all non-refundable.

Each Bid must be made upon blank forms provided by the Department and must be accompanied by a bid bond at 5% of the bid amount or an official bank check, cashier's check, certified check, certificate of deposit, or United States postal money order in the amount of 5% of the bid amount, payable to Treasurer, State of Maine as a Bid guarantee. A Contract Performance Surety Bond and a Contract Payment Surety Bond, each in the amount of 100 percent of the Contract price, will be required of the successful Bidder.

This Contract is subject to all applicable Federal Laws. This contract is subject to compliance with the Disadvantaged Business Enterprise program requirements as set forth by the Maine Department of Transportation.

All work shall be governed by *State of Maine, Department of Transportation, Standard Specifications, March 2020 Edition*, price \$10 [\$15 by mail], and *Standard Details, March 2020 Edition*, price \$10 [\$15 by mail]. They also may be purchased by telephone at (207) 624-3536 between the hours of 8:00 a.m. to 4:30 p.m. *Standard Detail* updates can be found at <http://www.maine.gov/mdot/contractors/publications/>.

The right is hereby reserved to the MaineDOT to reject any or all bids.

Augusta, Maine
March 16, 2022

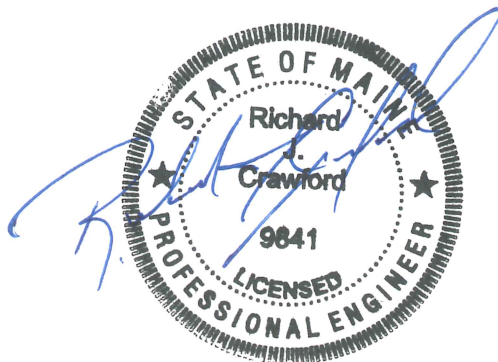

Richard Crawford P. E.
DEPUTY CHIEF ENGINEER

SPECIAL PROVISION 102.7.3
ACKNOWLEDGMENT OF BID AMENDMENTS

With this form, the Bidder acknowledges its responsibility to check for all Amendments to the Bid Package. For each Project under Advertisement, Amendments are located at <http://www.maine.gov/mdot/contractors/> . It is the responsibility of the Bidder to determine if there are Amendments to the Project, to download them, to incorporate them into their Bid Package, and to reference the Amendment number and the date on the form below. The Maine DOT will not post Bid Amendments any later than noon the day before Bid opening without individually notifying all the planholders.

Amendment Number	Date

The Contractor, for itself, its successors and assigns, hereby acknowledges that it has received all of the above referenced Amendments to the Bid Package.

CONTRACTOR

Date

Signature of authorized representative

(Name and Title Printed)

Maine Department of Transportation

Proposal Schedule of Items

Proposal ID: 024237.00

Project(s): 024237.00

SECTION: 1 Highway Items

Alt Set ID: Alt Mbr ID:

Contractor: _____

Proposal Line Number	Item ID Description	Approximate Quantity and Units	Unit Price		Bid Amount	
			Dollars	Cents	Dollars	Cents
0010	203.25 GRANULAR BORROW	23.000 CY	_____	 _____	_____	 _____
0020	206.07 STRUCTURAL ROCK EXCAVATION - DRAINAGE AND MINOR STRUCTURES	40.000 CY	_____	 _____	_____	 _____
0030	502.2483 PUMPED GROUT	5.000 CY	_____	 _____	_____	 _____
0040	502.325 STRUCTURAL CONCRETE CULVERT INVERT LINING	LUMP SUM		 LUMP SUM	_____	 _____
0050	502.326 STRUCTURAL CONCRETE - FISH WEIRS	LUMP SUM		 LUMP SUM	_____	 _____
0060	503.12 REINFORCING STEEL, FABRICATED AND DELIVERED	11,760.000 LB	_____	 _____	_____	 _____
0070	503.13 REINFORCING STEEL, PLACING	11,760.000 LB	_____	 _____	_____	 _____
0080	511.07 COFFERDAM: Downstream	LUMP SUM		 LUMP SUM	_____	 _____
0090	511.07 COFFERDAM: Upstream	LUMP SUM		 LUMP SUM	_____	 _____
0100	524.301 TEMPORARY STRUCTURAL SUPPORT	LUMP SUM		 LUMP SUM	_____	 _____
0110	610.08 PLAIN RIPRAP	150.000 CY	_____	 _____	_____	 _____
0120	620.58 EROSION CONTROL GEOTEXTILE	220.000 SY	_____	 _____	_____	 _____

Maine Department of Transportation

Proposal Schedule of Items

Proposal ID: 024237.00

Project(s): 024237.00

SECTION: 1 Highway Items

Alt Set ID: Alt Mbr ID:

Contractor: _____

Proposal Line Number	Item ID Description	Approximate Quantity and Units	Unit Price		Bid Amount	
			Dollars	Cents	Dollars	Cents
0130	629.05 HAND LABOR, STRAIGHT TIME	5.000 HR	_____	 _____	_____	 _____
0140	631.12 ALL PURPOSE EXCAVATOR (INCLUDING OPERATOR)	5.000 HR	_____	 _____	_____	 _____
0150	631.172 TRUCK - LARGE (INCLUDING OPERATOR)	5.000 HR	_____	 _____	_____	 _____
0160	652.34 CONE	20.000 EA	_____	 _____	_____	 _____
0170	652.35 CONSTRUCTION SIGNS	250.000 SF	_____	 _____	_____	 _____
0180	652.36 MAINTENANCE OF TRAFFIC CONTROL DEVICES	30.000 CD	_____	 _____	_____	 _____
0190	652.38 FLAGGER	125.000 HR	_____	 _____	_____	 _____
0200	652.41 PORTABLE CHANGEABLE MESSAGE SIGN	2.000 EA	_____	 _____	_____	 _____
0210	656.75 TEMPORARY SOIL EROSION AND WATER POLLUTION CONTROL	LUMP SUM		 LUMP SUM	_____	 _____
0220	659.10 MOBILIZATION	LUMP SUM		 LUMP SUM	_____	 _____
Section: 1			Total:		_____	
			Total Bid:		_____	

CONTRACT AGREEMENT, OFFER & AWARD

AGREEMENT made on the date last signed below, by and between the State of Maine, acting through and by its Department of Transportation (Department), an agency of state government with its principal administrative offices located at Child Street, Augusta, Maine, with a mailing address at 16 State House Station, Augusta, Maine 04333-0016, and

_____ a corporation or other legal entity organized under the laws of the State of _____, with its principal place of business located at _____

The Department and the Contractor, in consideration of the mutual promises set forth in this Agreement (the "Contract"), hereby agree as follows:

A. The Work.

The Contractor agrees to complete all Work as specified or indicated in the Contract including Extra Work in conformity with the Contract, **WIN. 024237.00** for **Large Culvert Rehabilitation** in the town of **Union** County of **Knox** Maine. The Work includes construction, maintenance during construction, warranty as provided in the Contract, and other incidental work.

The Contractor shall be responsible for furnishing all supervision, labor, equipment, tools supplies, permanent materials and temporary materials required to perform the Work including construction quality control including inspection, testing and documentation, all required documentation at the conclusion of the project, warranting its work and performing all other work indicated in the Contract.

The Department shall have the right to alter the nature and extent of the Work as provided in the Contract; payment to be made as provided in the same.

B. Time.

The Contractor agrees to complete all Work, except warranty work, on or before **October 29, 2022**. Further, the Department may deduct from moneys otherwise due the Contractor, not as a penalty, but as Liquidated Damages in accordance with Sections 107.7 and 107.8 of the *State of Maine Department of Transportation Standard Specifications, March 2020 Edition* and related Special Provisions.

C. Price.

The quantities given in the Schedule of Items of the Bid Package will be used as the basis for determining the original Contract amount and for determining the amounts of the required Performance Surety Bond and Payment Surety Bond, and that the amount of this offer is _____

\$ _____ Performance Bond and Payment Bond each being 100% of the amount of this Contract.

D. Contract.

This Contract, which may be amended, modified, or supplemented in writing only, consists of the Contract documents as defined in the Plans, *Standard Specifications, March 2020 Edition, Standard Details March 2020 Edition* as updated through advertisement, Supplemental Specifications, Special Provisions, Contract Agreement; and Contract Bonds. It is agreed and understood that this Contract will be governed by the documents listed above.

E. Certifications.

By signing below, the Contractor hereby certifies that to the best of the Contractor's knowledge and belief:

1. All of the statements, representations, covenants, and/or certifications required or set forth in the Bid and the Bid Documents, including those in the Federal Contract Provisions Supplement, and the Contract are still complete and accurate as of the date of this Agreement.
2. The Contractor knows of no legal, contractual, or financial impediment to entering into this Contract.
3. The person signing below is legally authorized by the Contractor to sign this Contract on behalf of the Contractor and to legally bind the Contractor to the terms of the Contract.

F. Offer.

The undersigned, having carefully examined the site of work, the Plans, *Standard Specifications March 2020 Edition*, *Standard Details March 2020 Edition* as updated through advertisement, Supplemental Specifications, Special Provisions, Contract Agreement; and Contract Bonds contained herein for construction of:

WIN. 024237.00 - Large Culvert Rehabilitation - in the town of Union

State of Maine, on which bids will be received until the time specified in the “Notice to Contractors” do(es) hereby bid and offer to enter into this contract to supply all the materials, tools, equipment and labor to construct the whole of the Work in strict accordance with the terms and conditions of this Contract at the unit prices in the attached “Schedule of Items.”

The Offeror agrees to perform the work required at the price specified above and in accordance with the bids provided in the attached “Schedule of Items” in strict accordance with the terms of this solicitation, and to provide the appropriate insurance and bonds if this offer is accepted by the Government in writing.

As Offeror also agrees:

First: To do any extra work, not covered by the attached “Schedule of Items,” which may be ordered by the Resident, and to accept as full compensation the amount determined upon a “Force Account” basis as provided in the *Standard Specifications, March 2020 Edition*, and as addressed in the contract documents.

Second: That the bid bond at 5% of the bid amount or the official bank check, cashier’s check, certificate of deposit or U. S. Postal Money Order in the amount given in the “Notice to Contractors”, payable to the Treasurer of the State of Maine and accompanying this bid, shall be forfeited, as liquidated damages, if in case this bid is accepted, and the undersigned shall fail to abide by the terms and conditions of the offer and fail to furnish satisfactory insurance and Contract bonds under the conditions stipulated in the Specifications within 15 days of notice of intent to award the contract.

Third: To begin the Work as stated in Section 107.2 of the *Standard Specifications March 2020 Edition* and complete the Work within the time limits given in the Special Provisions of this Contract.

Fourth: The Contractor will be bound to the Disadvantaged Business Enterprise (DBE) Requirements contained in the attached Notice (Additional Instructions to Bidders) and submit a completed Contractor’s Disadvantaged Business Enterprise Utilization Plan with their bid.

Fifth: That this offer shall remain open for 30 calendar days after the date of opening of bids.

Sixth: The Bidder hereby certifies, to the best of its knowledge and belief that: the Bidder has not, either directly or indirectly, entered into any agreement, participated in any collusion, or otherwise taken any action in restraint of competitive bidding in connection with its bid, and its subsequent contract with the Department.

IN WITNESS WHEREOF, the Contractor, for itself, its successors and assigns, hereby execute two duplicate originals of this Agreement and thereby binds itself to all covenants, terms, and obligations contained in the Contract Documents.

CONTRACTOR

Date

(Signature of Legally Authorized Representative
of the Contractor)

Witness

(Name and Title Printed)

G. Award.

Your offer is hereby accepted.
documents referenced herein.

This award consummates the Contract, and the

MAINE DEPARTMENT OF TRANSPORTATION

Date

By: Bruce A. Van Note, Commissioner

Witness

CONTRACT AGREEMENT, OFFER & AWARD

AGREEMENT made on the date last signed below, by and between the State of Maine, acting through and by its Department of Transportation (Department), an agency of state government with its principal administrative offices located at Child Street, Augusta, Maine, with a mailing address at 16 State House Station, Augusta, Maine 04333-0016, and

_____ a corporation or other legal entity organized under the laws of the State of _____, with its principal place of business located at _____

The Department and the Contractor, in consideration of the mutual promises set forth in this Agreement (the "Contract"), hereby agree as follows:

A. The Work.

The Contractor agrees to complete all Work as specified or indicated in the Contract including Extra Work in conformity with the Contract, **WIN. 024237.00** for **Large Culvert Rehabilitation** in the town of **Union** County of **Knox** Maine. The Work includes construction, maintenance during construction, warranty as provided in the Contract, and other incidental work.

The Contractor shall be responsible for furnishing all supervision, labor, equipment, tools supplies, permanent materials and temporary materials required to perform the Work including construction quality control including inspection, testing and documentation, all required documentation at the conclusion of the project, warranting its work and performing all other work indicated in the Contract.

The Department shall have the right to alter the nature and extent of the Work as provided in the Contract; payment to be made as provided in the same.

B. Time.

The Contractor agrees to complete all Work, except warranty work, on or before **October 29, 2022**. Further, the Department may deduct from moneys otherwise due the Contractor, not as a penalty, but as Liquidated Damages in accordance with Sections 107.7 and 107.8 of the *State of Maine Department of Transportation Standard Specifications, March 2020 Edition* and related Special Provisions.

C. Price.

The quantities given in the Schedule of Items of the Bid Package will be used as the basis for determining the original Contract amount and for determining the amounts of the required Performance Surety Bond and Payment Surety Bond, and that the amount of this offer is _____

\$ _____ Performance Bond and Payment Bond each being 100% of the amount of this Contract.

D. Contract.

This Contract, which may be amended, modified, or supplemented in writing only, consists of the Contract documents as defined in the Plans, *Standard Specifications, March 2020 Edition, Standard Details March 2020 Edition* as updated through advertisement, Supplemental Specifications, Special Provisions, Contract Agreement; and Contract Bonds. It is agreed and understood that this Contract will be governed by the documents listed above.

E. Certifications.

By signing below, the Contractor hereby certifies that to the best of the Contractor's knowledge and belief:

1. All of the statements, representations, covenants, and/or certifications required or set forth in the Bid and the Bid Documents, including those in the Federal Contract Provisions Supplement, and the Contract are still complete and accurate as of the date of this Agreement.
2. The Contractor knows of no legal, contractual, or financial impediment to entering into this Contract.
3. The person signing below is legally authorized by the Contractor to sign this Contract on behalf of the Contractor and to legally bind the Contractor to the terms of the Contract.

F. Offer.

The undersigned, having carefully examined the site of work, the Plans, *Standard Specifications March 2020 Edition*, *Standard Details March 2020 Edition* as updated through advertisement, Supplemental Specifications, Special Provisions, Contract Agreement; and Contract Bonds contained herein for construction of:

WIN. 024237.00 - Large Culvert Rehabilitation - in the town of Union

State of Maine, on which bids will be received until the time specified in the “Notice to Contractors” do(es) hereby bid and offer to enter into this contract to supply all the materials, tools, equipment and labor to construct the whole of the Work in strict accordance with the terms and conditions of this Contract at the unit prices in the attached “Schedule of Items.”

The Offeror agrees to perform the work required at the price specified above and in accordance with the bids provided in the attached “Schedule of Items” in strict accordance with the terms of this solicitation, and to provide the appropriate insurance and bonds if this offer is accepted by the Government in writing.

As Offeror also agrees:

First: To do any extra work, not covered by the attached “Schedule of Items,” which may be ordered by the Resident, and to accept as full compensation the amount determined upon a “Force Account” basis as provided in the *Standard Specifications, March 2020 Edition*, and as addressed in the contract documents.

Second: That the bid bond at 5% of the bid amount or the official bank check, cashier’s check, certificate of deposit or U. S. Postal Money Order in the amount given in the “Notice to Contractors”, payable to the Treasurer of the State of Maine and accompanying this bid, shall be forfeited, as liquidated damages, if in case this bid is accepted, and the undersigned shall fail to abide by the terms and conditions of the offer and fail to furnish satisfactory insurance and Contract bonds under the conditions stipulated in the Specifications within 15 days of notice of intent to award the contract.

Third: To begin the Work as stated in Section 107.2 of the *Standard Specifications March 2020 Edition* and complete the Work within the time limits given in the Special Provisions of this Contract.

Fourth: The Contractor will be bound to the Disadvantaged Business Enterprise (DBE) Requirements contained in the attached Notice (Additional Instructions to Bidders) and submit a completed Contractor’s Disadvantaged Business Enterprise Utilization Plan with their bid.

Fifth: That this offer shall remain open for 30 calendar days after the date of opening of bids.

Sixth: The Bidder hereby certifies, to the best of its knowledge and belief that: the Bidder has not, either directly or indirectly, entered into any agreement, participated in any collusion, or otherwise taken any action in restraint of competitive bidding in connection with its bid, and its subsequent contract with the Department.

IN WITNESS WHEREOF, the Contractor, for itself, its successors and assigns, hereby execute two duplicate originals of this Agreement and thereby binds itself to all covenants, terms, and obligations contained in the Contract Documents.

CONTRACTOR

Date

(Signature of Legally Authorized Representative
of the Contractor)

Witness

(Name and Title Printed)

G. Award.

Your offer is hereby accepted.
documents referenced herein.

This award consummates the Contract, and the

MAINE DEPARTMENT OF TRANSPORTATION

Date

By: Bruce A. Van Note, Commissioner

Witness

CONTRACT AGREEMENT, OFFER & AWARD

AGREEMENT made on the date last signed below, by and between the State of Maine, acting through and by its Department of Transportation (Department), an agency of state government with its principal administrative offices located at Child Street Augusta, Maine, with a mailing address at 16 State House Station, Augusta, Maine 04333-0016, and (Name of the firm bidding the job) a corporation or other legal entity organized under the laws of the State of Maine, with its principal place of business located at (address of the firm bidding the job)

The Department and the Contractor, in consideration of the mutual promises set forth in this Agreement (the "Contract"), hereby agree as follows:

A. The Work.

The Contractor agrees to complete all Work as specified or indicated in the Contract including Extra Work in conformity with the Contract, PIN No.0112345.00, for the **Hot Mix Asphalt Overlay** in the town/city of **South Nowhere**, County of **Washington**, Maine. The Work includes construction, maintenance during construction, warranty as provided in the Contract, and other incidental work.

The Contractor shall be responsible for furnishing all supervision, labor, equipment, tools supplies, permanent materials and temporary materials required to perform the Work including construction quality control including inspection, testing and documentation, all required documentation at the conclusion of the project, warranting its work and performing all other work indicated in the Contract.

The Department shall have the right to alter the nature and extent of the Work as provided in the Contract; payment to be made as provided in the same.

B. Time.

The Contractor agrees to complete all Work, except warranty work, on or before **November 15, 2006**. Further, the Department may deduct from moneys otherwise due the Contractor, not as a penalty, but as Liquidated Damages in accordance with Sections 107.7 and 107.8 of the *State of Maine Department of Transportation Standard Specifications, March 2020 Edition* and related Special Provisions.

C. Price.

The quantities given in the Schedule of Items of the Bid Package will be used as the basis for determining the original Contract amount and for determining the amounts of the required Performance Surety Bond and Payment Surety Bond, and that the amount of this offer is (Place bid here in alphabetical form such as One Hundred and Two dollars and 10 cents)
\$ (repeat bid here in numerical terms, such as \$102.10) Performance Bond and Payment Bond each being 100% of the amount of this Contract.

D. Contract.

This Contract, which may be amended, modified, or supplemented in writing only, consists of the Contract documents as defined in the Plans, *Standard Specifications, March 2020 Edition, Standard Details March 2020 Edition*, Supplemental Specifications, Special Provisions, Contract Agreement; and Contract Bonds. It is agreed and understood that this Contract will be governed by the documents listed above.

E. Certifications.

By signing below, the Contractor hereby certifies that to the best of the Contractor's knowledge and belief:

1. All of the statements, representations, covenants, and/or certifications required or set forth in the Bid and the Bid Documents, including those in Appendix A to Division 100 of the *Standard Specifications March 2020 Edition* (Federal Contract Provisions Supplement), and the Contract are still complete and accurate as of the date of this Agreement.
2. The Contractor knows of no legal, contractual, or financial impediment to entering into this Contract.
3. The person signing below is legally authorized by the Contractor to sign this Contract on behalf of the Contractor and to legally bind the Contractor to the terms of the Contract.

F. Offer.

The undersigned, having carefully examined the site of work, the Plans, *Standard Specifications, March 2020 Edition, Standard Details March 2020 Edition*, Supplemental Specifications, Special Provisions, Contract Agreement; and Contract Bonds contained herein for construction of:

PIN 012345.00 South Nowhere, Hot Mix Asphalt Overlay

State of Maine, on which bids will be received until the time specified in the "Notice to Contractors" do(es) hereby bid and offer to enter into this contract to supply all the materials, tools, equipment and labor to construct the whole of the Work in strict accordance with the terms and conditions of this Contract at the unit prices in the attached "Schedule of Items."

The Offeror agrees to perform the work required at the price specified above and in accordance with the bids provided in the attached "Schedule of Items" in strict accordance with the terms of this solicitation, and to provide the appropriate insurance and bonds if this offer is accepted by the Government in writing.

As Offeror also agrees:

First: To do any extra work, not covered by the attached "Schedule of Items," which may be ordered by the Resident, and to accept as full compensation the amount determined upon a "Force Account" basis as provided in the *Standard Specifications, March 2020 Edition*, and as addressed in the contract documents.

Second: That the bid bond at 5% of the bid amount or the official bank check, cashier's check, certificate of deposit or U. S. Postal Money Order in the amount given in the "Notice to Contractors", payable to the Treasurer of the State of Maine and accompanying this bid, shall be forfeited, as liquidated damages, if in case this bid is accepted, and the undersigned shall fail to abide by the terms and conditions of the offer and fail to furnish satisfactory insurance and Contract bonds under the conditions stipulated in the Specifications within 15 days of notice of intent to award the contract.

Third: To begin the Work as stated in Section 107.2 of the *Standard Specifications March 2020 Edition* and complete the Work within the time limits given in the Special Provisions of this Contract.

Fourth: The Contractor will be bound to the Disadvantaged Business Enterprise (DBE) Requirements contained in the attached Notice (Additional Instructions to Bidders) and submit a completed Contractor's Disadvantaged Business Enterprise Utilization Plan with their bid.

Fifth: That this offer shall remain open for 30 calendar days after the date of opening of bids.

Sixth: The Bidder hereby certifies, to the best of its knowledge and belief that: the Bidder has not, either directly or indirectly, entered into any agreement, participated in any collusion, or otherwise taken any action in restraint of competitive bidding in connection with its bid, and its subsequent contract with the Department.

IN WITNESS WHEREOF, the Contractor, for itself, its successors and assigns, hereby execute two duplicate originals of this Agreement and thereby binds itself to all covenants, terms, and obligations contained in the Contract Documents.

Date

(Witness Sign Here)
Witness

(Sign Here)
(Signature of Legally Authorized Representative of the Contractor)

(Print Name Here)
(Name and Title Printed)

CONTRACTOR

G. Award.

Your offer is hereby accepted.
documents referenced herein.

This award consummates the Contract, and the

MAINE DEPARTMENT OF TRANSPORTATION

Date

By: Bruce A. Van Note, Commissioner

(Witness)

BOND # _____

CONTRACT PERFORMANCE BOND
(Surety Company Form)

KNOW ALL MEN BY THESE PRESENTS: That _____
_____ in the State of _____, as principal,
and.....
a corporation duly organized under the laws of the State of and having a
usual place of business
as Surety, are held and firmly bound unto the Treasurer of the State of Maine in the sum
of _____ and 00/100 Dollars (\$ _____),
to be paid said Treasurer of the State of Maine or his successors in office, for which
payment well and truly to be made, Principal and Surety bind themselves, their heirs,
executors and administrators, successors and assigns, jointly and severally by these
presents.

The condition of this obligation is such that if the Principal designated as Contractor in
the Contract to construct Project Number _____ in the Municipality of
_____ promptly and faithfully performs the Contract, then this
obligation shall be null and void; otherwise it shall remain in full force and effect.

The Surety hereby waives notice of any alteration or extension of time made by the State
of Maine.

Signed and sealed this day of, 20.....

WITNESSES:

SIGNATURES:

CONTRACTOR:

Signature.....

.....

Print Name Legibly

Print Name Legibly

SURETY:

Signature

.....

Print Name Legibly

Print Name Legibly

SURETY ADDRESS:

NAME OF LOCAL AGENCY:

.....
.....
.....

ADDRESS
.....
.....

TELEPHONE.....

.....

BOND # _____

CONTRACT PAYMENT BOND
(Surety Company Form)

KNOW ALL MEN BY THESE PRESENTS: That _____
_____ **in the State of** _____, as principal,
and.....
a corporation duly organized under the laws of the State of and having a
usual place of business in
as Surety, are held and firmly bound unto the Treasurer of the State of Maine for the use
and benefit of claimants as herein below defined, in the sum of
_____ **and 00/100 Dollars (\$** _____ **)**
for the payment whereof Principal and Surety bind themselves, their heirs, executors and
administrators, successors and assigns, jointly and severally by these presents.

The condition of this obligation is such that if the Principal designated as Contractor in
the Contract to construct Project Number _____ in the Municipality of
_____ promptly satisfies all claims and demands incurred for all
labor and material, used or required by him in connection with the work contemplated by
said Contract, and fully reimburses the obligee for all outlay and expense which the
obligee may incur in making good any default of said Principal, then this obligation shall
be null and void; otherwise it shall remain in full force and effect.

A claimant is defined as one having a direct contract with the Principal or with a
Subcontractor of the Principal for labor, material or both, used or reasonably required for
use in the performance of the contract.

Signed and sealed this day of, 20

WITNESS:

SIGNATURES:

CONTRACTOR:

Signature.....

.....

Print Name Legibly

Print Name Legibly

SURETY:

Signature.....

.....

Print Name Legibly

Print Name Legibly

SURETY ADDRESS:

NAME OF LOCAL AGENCY:

.....

ADDRESS

.....

.....

TELEPHONE

.....

	Rates	Fringes
CARPENTER, Includes Form Work....	\$ 18.34	2.84
HIGHWAY/PARKING LOT STRIPING: Laborer.....	\$ 14.80	1.27
IRONWORKER, REINFORCING.....	\$ 16.27	0.00
LABORER: Asphalt, Includes Raker, Shoveler, Spreader and Distributor.....	\$ 15.40	2.69
LABORER: Common or General.....	\$ 14.56	0.00
LABORER: Landscape.....	\$ 18.69	2.70
LABORER: Wheelman.....	\$ 15.64	4.29
OPERATOR: Backhoe/Excavator/Trackhoe.....	\$ 18.83	4.08
OPERATOR: Bobcat/Skid Steer/Skid Loader.....	\$ 21.66	4.91
OPERATOR: Broom/Sweeper.....	\$ 19.09	5.20
OPERATOR: Bulldozer.....	\$ 17.30	3.50
OPERATOR: Loader.....	\$ 18.59	5.53
OPERATOR: Mechanic.....	\$ 22.07	8.73
OPERATOR: Paver (Asphalt, Aggregate, and Concrete).....	\$ 21.46	8.78
OPERATOR: Screed.....	\$ 19.02	4.82
OPERATOR: Roller (Earth).....	\$ 16.43	3.40
OPERATOR: Roller Asphalt.....	\$ 21.97	7.81
TRAFFIC CONTROL: Flagger.....	\$ 9.38	0.00
TRAFFIC CONTROL: Laborer-Cones/ Barricades/Barrels - Setter/Mover/Sweeper.....	\$ 17.47	4.80
TRUCK DRIVER: Dump Truck.....	\$ 16.68	2.79
TRUCK DRIVER: TackTruck.....	\$ 20.18	7.75

WELDERS - Receive rate prescribed for craft performing operation to which welding is incidental.

=====
Note: Executive Order (EO) 13706, Establishing Paid Sick Leave for Federal Contractors applies to all contracts subject to the Davis-Bacon Act for which the contract is awarded (and any solicitation was issued) on or after January 1, 2017. If this contract is covered by the EO, the contractor must provide employees with 1 hour of paid sick leave for every 30 hours

they work, up to 56 hours of paid sick leave each year. Employees must be permitted to use paid sick leave for their own illness, injury or other health-related needs, including preventive care; to assist a family member (or person who is like family to the employee) who is ill, injured, or has other health-related needs, including preventive care; or for reasons resulting from, or to assist a family member (or person who is like family to the employee) who is a victim of, domestic violence, sexual assault, or stalking. Additional information on contractor requirements and worker protections under the EO is available at www.dol.gov/whd/govcontracts.

Unlisted classifications needed for work not included within the scope of the classifications listed may be added after award only as provided in the labor standards contract clauses (29CFR 5.5 (a) (1) (ii)).

The body of each wage determination lists the classification and wage rates that have been found to be prevailing for the cited type(s) of construction in the area covered by the wage determination. The classifications are listed in alphabetical order of ""identifiers"" that indicate whether the particular rate is a union rate (current union negotiated rate for local), a survey rate (weighted average rate) or a union average rate (weighted union average rate).

Union Rate Identifiers

A four letter classification abbreviation identifier enclosed in dotted lines beginning with characters other than ""SU"" or ""UAVG"" denotes that the union classification and rate were prevailing for that classification in the survey. Example: PLUM0198-005 07/01/2014. PLUM is an abbreviation identifier of the union, which prevailed in the survey for this classification, which in this example would be Plumbers 0198 indicates the local union number or district council number where applicable, i.e., Plumbers Local 0198. The next number, 005 in the example, is an internal number used in processing the wage determination. 07/01/2014 is the effective date of the most current negotiated rate, which in this example is July 1, 2014.

Union prevailing wage rates are updated to reflect all rate changes in the collective bargaining agreement (CBA) governing this classification and rate.

Survey Rate Identifiers

Classifications listed under the ""SU"" identifier indicate that no one rate prevailed for this classification in the survey and the published rate is derived by computing a weighted average rate based on all the rates reported in the survey for that classification. As this weighted average rate includes all rates reported in the survey, it may include both union and non-union rates. Example: SULA2012-007 5/13/2014. SU indicates the rates are survey rates based on a weighted average calculation of rates and are not majority rates. LA indicates the State of Louisiana. 2012 is the year of survey on which these classifications and rates are based. The next number, 007 in the example, is an internal number used in producing the wage determination. 5/13/2014 indicates the survey completion

date for the classifications and rates under that identifier.

Survey wage rates are not updated and remain in effect until a new survey is conducted.

Union Average Rate Identifiers

Classification(s) listed under the UAVG identifier indicate that no single majority rate prevailed for those classifications; however, 100% of the data reported for the classifications was union data. EXAMPLE: UAVG-OH-0010 08/29/2014. UAVG indicates that the rate is a weighted union average rate. OH indicates the state. The next number, 0010 in the example, is an internal number used in producing the wage determination. 08/29/2014 indicates the survey completion date for the classifications and rates under that identifier.

A UAVG rate will be updated once a year, usually in January of each year, to reflect a weighted average of the current negotiated/CBA rate of the union locals from which the rate is based.

WAGE DETERMINATION APPEALS PROCESS

1.) Has there been an initial decision in the matter? This can be:

- * an existing published wage determination
- * a survey underlying a wage determination
- * a Wage and Hour Division letter setting forth a position on a wage determination matter
- * a conformance (additional classification and rate) ruling

On survey related matters, initial contact, including requests for summaries of surveys, should be with the Wage and Hour Division National Office Branch of Wage Surveys. If the response from this initial contact is not satisfactory, then the process described in 2.) and 3.) should be followed.

With regard to any other matter not yet ripe for the formal process described here, initial contact should be with the Branch of Construction Wage Determinations. Write to:

Branch of Construction Wage Determinations
Wage and Hour Division
U.S. Department of Labor
200 Constitution Avenue, N.W.
Washington, DC 20210

2.) If the answer to the question in 1.) is yes, then an interested party (those affected by the action) can request review and reconsideration from the Wage and Hour Administrator (See 29 CFR Part 1.8 and 29 CFR Part 7). Write to:

Wage and Hour Administrator
U.S. Department of Labor
200 Constitution Avenue, N.W.
Washington, DC 20210

The request should be accompanied by a full statement of the interested party's position and by any information (wage

payment data, project description, area practice material, etc.) that the requestor considers relevant to the issue.

3.) If the decision of the Administrator is not favorable, an interested party may appeal directly to the Administrative Review Board (formerly the Wage Appeals Board). Write to:

Administrative Review Board
U.S. Department of Labor
200 Constitution Avenue, N.W.
Washington, DC 20210

4.) All decisions by the Administrative Review Board are final.

=====

END OF GENERAL DECISION"

State of Maine
 Department of Labor
 Bureau of Labor Standards
 Augusta, Maine 04333-0045
 Telephone (207) 623-7906

Wage Determination - In accordance with 26 MRS §1301 et. seq., this is a determination by the Bureau of Labor Standards, of the fair minimum wage rate to be paid to laborers and workers employed on the below titled project.

**2022 Fair Minimum Wage Rates
 Highway & Earth Knox County**

Occupational Title	Minimum Wage	Minimum Benefit	Total
Carpenter	\$26.00	\$4.69	\$30.69
Cement Masons And Concrete Finisher	\$20.00	\$0.00	\$20.00
Commercial Divers	\$28.00	\$2.50	\$30.50
Construction And Maintenance Painters	\$23.34	\$2.53	\$25.87
Construction Laborer	\$20.00	\$0.23	\$20.23
Control And Valve Installers And Repairers - Except Mechanical Door	\$26.00	\$5.49	\$31.49
Conveyor Operators And Tenders	\$18.00	\$2.71	\$20.71
Crane And Tower Operators	\$31.54	\$6.68	\$38.22
Crushing Grinding And Polishing Machine Operators	\$21.00	\$5.94	\$26.94
Earth Drillers - Except Oil And Gas	\$23.25	\$5.53	\$28.78
Electricians	\$48.50	\$23.17	\$71.67
Excavating And Loading Machine And Dragline Operators	\$27.13	\$4.73	\$31.86
Fence Erectors	\$18.00	\$0.72	\$18.72
Flaggers	\$15.25	\$0.00	\$15.25
Heating And Air Conditioning And Refrigeration Mechanics And Installers	\$26.33	\$4.06	\$30.39
Heavy And Tractor - Trailer Truck Drivers	\$22.87	\$4.85	\$27.72
Highway Maintenance Workers	\$20.74	\$5.37	\$26.11
Industrial Machinery Mechanics	\$26.00	\$5.19	\$31.19
Industrial Truck And Tractor Operators	\$24.00	\$5.61	\$29.61
Light Truck Or Delivery Services Drivers	\$20.00	\$6.10	\$26.10
Millwrights	\$25.13	\$3.51	\$28.64
Mixing And Blending Machine Operators	\$24.71	\$8.59	\$33.30
Mobile Heavy Equipment Mechanics - Except Engines	\$25.00	\$5.63	\$30.63
Operating Engineers And Other Equipment Operators	\$27.91	\$4.95	\$32.86
Paving Surfacing And Tamping Equipment Operators	\$24.71	\$5.86	\$30.57
Pipelayers	\$28.00	\$7.20	\$35.20
Plumbers Pipe Fitters And Steamfitters	\$26.00	\$2.93	\$28.93
Reinforcing Iron And Rebar Workers	\$48.58	\$0.00	\$48.58
Structural Iron And Steel Workers	\$24.00	\$1.36	\$25.36

Welders are classified as the trade to which welding is incidental (e.g. welding structural steel is Structural Iron and Steel Worker)

Apprentices – The minimum wage rate for registered apprentices are those set forth in the standards and policies of the Maine State Apprenticeship and Training Council for approved apprenticeship programs.

For any other specific trade on this project not listed above, contact the Bureau of Labor Standards for further clarification.

Title 26 §1310 requires that a clearly legible statement of all fair minimum wage and benefits rates to be paid the several classes of laborers, workers and mechanics employed on the construction on the public work must be kept posted in a prominent and easily accessible place at the site by each contractor and subcontractor subject to sections 1304 to 1313.

Appeal – Any person affected by the determination of these rates may appeal to the Commissioner of Labor by filing a written notice with the Commissioner stating the specific grounds of the objection within ten (10) days from the filing of these rates.

A true copy

Attest: 
 Scott R. Cotnoir
 Wage & Hour Director
 Bureau of Labor Standards

Expiration Date: 12-31-2022

SPECIAL PROVISION
SECTION 104
(WAGE RATES)

When two or more wage rate schedules appear in the bid Book, the highest rate shall prevail for each classification.

SPECIAL PROVISIONS
SECTION 104
Utilities

UTILITY COORDINATION

The contractor has primary responsibility for coordinating their work with utilities after contract award. The contractor shall communicate directly with the utilities regarding any utility work necessary to maintain the contractor’s schedule and prevent project construction delays. The contractor shall notify the resident of any issues.

THE CONTRACTOR SHALL PLAN AND CONDUCT WORK ACCORDINGLY.

MEETING

A Preconstruction Utility Conference, as defined in Subsection 104.4.6 of the Standard Specifications **is not** required.

GENERAL INFORMATION

These Special Provisions outline the arrangements that have been made by the Department for utility and/or railroad work to be undertaken in conjunction with this project. The following list identifies all known utilities or railroads having facilities presently located within the limits of this project or intending to install facilities during project construction. Utilities have been notified and will be furnished a project specification.

The contractor shall give all Utilities 10 working days’ notice prior to beginning any work on this project.

Overview and Utility Contact Information:

Utility/ NO Railroad	Aerial	Subsurface	Contact Person	Contact Phone
Central Maine Power Company	X		James Cobb	(207)530-1536
Charter Communications	X		Joshua Mooers	(207)446-8553
Tidewater Telecom	X		Jim Corbett	(207)380-9317

**** Specific information regarding the line voltage can be requested from Central Maine Power ****

Temporary utility adjustments **are not** anticipated. If any unexpected utility relocations become necessary, they shall be scheduled in accordance with Section 104 of the Standard Specifications and shall be performed by the appropriate utility company in conjunction with the work by the Contractor. Should the Contractor choose to have any poles temporarily relocated, all work shall be done at the Contractor’s request and expense, with no additional cost or schedule impacts to the Department.

No utility adjustments, aerial or underground, are anticipated as part of this project. If utility relocations, though unexpected, become necessary, they will be scheduled in compliance with Section 104 of the Standard Specifications and will be done by the utilities in conjunction with the work by the Contractor.

MAINTAINING UTILITY LOCATION MARKINGS

The Contractor will be responsible for maintaining the buried utility location markings following the initial locating by the appropriate utility or their designated representative.

UTILITY SIGNING

Any utility working within the construction limits of this project shall ensure that the traveling public is adequately protected at all times. All work areas shall be signed, lighted, and traffic flaggers employed as determined by field conditions. All traffic controls shall be in accordance with the latest edition of the Manual on Uniform Traffic Control Devices for Streets and Highways, as issued by the Federal Highway Administration.

SPECIAL PROVISION
SECTION 104
GENERAL RIGHTS AND RESPONSIBILITIES
(Electronic Payroll Submission)
(Payment Tracking)

104.3.8.1 Electronic Payroll Submission The prime contractor and all subcontractors and lower-tier subcontractors will submit their certified payrolls electronically on this contract utilizing the Elation System web based reporting. There is no charge to the contracting community for the use of this service. The submission of paper payrolls will not be allowed or accepted. Additional information can be found at <http://www.maine.gov/mdot/contractors/> under the first “Notice”.

104.3.8.2 Payment Tracking The prime contractor and all subcontractors and lower-tier subcontractors will track and confirm the delivery and receipt of all payments through the Elation System

SPECIAL PROVISION
SECTION 105
GENERAL SCOPE OF WORK
(Environmental Requirements)

Work within stream (“In Stream Work,” see MaineDOT Standard Specifications 101.2 Definitions) requires special conditions to minimize impacts. The following special conditions shall apply to this project:

- I. In Stream Work shall be allowed at any time for Large Culvert #46462 STA: 13+50 (coordinates: 44.216287, -69.272365) for permit NAE-2021-02552. This location has an open in stream work window, there are no time of year restrictions.
- II. Special Conditions of Army Corps of Engineers (ACOE) Maine General Permits 22 Permit #NAE-2021-02552 apply (see permit and conditions in contract documents).
- III. To minimize the effects to the Federal Endangered Species Atlantic salmon (ATS), the following Special Conditions apply to the In Stream Work locations:
 1. All in-water excavation shall be conducted within a sealed cofferdam.
 2. The contractor shall contact Kevin Miller (207-446-8724, Kevin.Miller@maine.gov) and Justin Sweitzer of MaineDOT’s Environmental Office (207-441-0651, justin.sweitzer@maine.gov) at least 2 weeks prior to installation of cofferdams to coordinate fish evacuation. Cofferdams must be dewatered to less than 2 feet deep to facilitate Fish Evacuation.
 3. Sheet pile driving (if utilized) will be completed using a vibratory hammer.
 4. All areas of temporary waterway or wetland fill shall be restored to their original contour and character upon completion of the project. Temporary fill includes fill that received authorization and fill that mistakenly enters a resource (i.e., from slope failures or accidental broken sandbag cofferdams).
 5. All areas of disturbed soil shall be mulched and seeded with an approved native or non-invasive herbaceous seed mix following construction and/or planted with native woody vegetation and trees appropriate during the first available planting season. In areas where there is little to no slope, and erosion and invasive species establishment is unlikely, the native woody vegetation on the site shall be allowed to regenerate naturally.
 6. Grubbing (removal) of roots and stumps shall only occur in those areas subject to permanent impacts.
 7. All off-road equipment working within 25-feet of a stream (RUS) shall be cleaned to remove all soil, seeds, vegetation, or other debris that could contain seeds or reproductive portions of plants prior to entering the area to minimize the spread of noxious weeds. All equipment shall be inspected prior to offloading to ensure they are clean.

8. Heavy construction equipment shall travel only over non-erodible stream substrate (e.g., ledge, cobble) and when approved by the MaineDOT Environmental Field Contact.
9. Suspended sediment treatment shall follow the procedures described in the Standard Specifications for Dirty Water Treatment System. Operation shall follow the specifications of the SEWPCP.
10. All cofferdams will be removed using techniques to minimize turbidity releases. This includes allowing for the slow reintroduction of water into the work area and utilizing dirty water treatment systems for turbid water.
11. No equipment, materials, or machinery shall be stored, cleaned, fueled, or repaired within any wetland or stream resource. These activities shall occur more than 100 feet from any wetland or stream resource and shall follow the specifications of the SEWPCP.
12. All pumps and generators required for in-stream work shall be cleaned of external oil, grease, dirt, and mud such that turbid water does not drain to any wetland or stream. Any leaks of this equipment shall be fixed prior to entering streams or areas that drain directly to streams or wetlands. Operation shall follow the specifications of the SEWPCP.
13. Stabilization techniques (such as placing sheets of poly at the bypass outlet) will be used to protect the stream from scour caused by the high water velocities associated with bypass pumping activities (if required).
14. Bypass pumping systems will be sized to accommodate the predicted peak flow rate during construction. Predicted peak flows are provided to the contractor in the bid documents
15. When utilizing pumps to dewater cofferdams, in order to prevent ATS juvenile entrapment related to dewatering diversions, the Contractor will use a screen on each pump intake designed such that the approach velocity does not exceed 0.20 feet/second. Square or round screen face openings are not to exceed 3/32 inches (2.38 millimeters) measured on a diagonal. Criteria for slotted face openings shall not exceed 1/16 inches (approximately 1.75 millimeters) in the narrow direction. These screen criteria follow National Marine Fisheries Service (NMFS) guidance (NMFS 2008). Intake hoses shall be regularly monitored while pumping to minimize adverse effects to Atlantic salmon or other species.

V. Approvals:

1. Soil Erosion and Water Pollution Control Plan (SEWPCP)
2. Permitted Protected Natural Resource Impacts, see Corps Maine GP 22 Permit Number NAE-2021-02552 and Maine Department of Environmental Protection Section 11 permit-by-rule Stream (RUS)
 - Permanent: 859 s.f.
 - Temporary: 657 s.f. – due to cofferdams/dewatering

Wetland

Permanent: N/A

Temporary: 869 s.f.- due to cofferdams/dewatering

VI. No work is allowed that completely blocks a river, stream, or brook without providing downstream flow.

VII. All activities are prohibited (including placement and removal of cofferdams unless otherwise permitted by Regulatory Agencies) below the normal high water mark if outside of cofferdam constructed according to permit# NAE-2021-02552, MaineDOT's Standard Specifications, and in adherence with the Contractors approved SEWPCP.

NOTE: Reauthorization of the ACOE Permit is required for any work in jurisdictional resources that is not completed by October 14, 2025. The Contractor shall allow up to 2 weeks for MaineDOT to reauthorize the permit prior to beginning construction

Union
24237.00
Route 17
April 1, 2021

SPECIAL PROVISION
SECTION 105
(LIMITATION OF OPERATIONS)

1. The Contractor shall maintain a minimum of one 11-foot lane with alternating traffic at all times.

SPECIAL PROVISION 105
GENERAL SCOPE OF WORK
Equal Opportunity and Civil Rights
(Disadvantaged Business Enterprises Program)

105.10.1.1 Disadvantaged Business Enterprises Program The Maine Department of Transportation (MaineDOT) has established a Disadvantaged Business Enterprise (DBE) program in accordance with regulations of the United States Department of Transportation (USDOT), 49 CFR Part 26. The MaineDOT receives federal financial assistance from USDOT, and as a condition of receiving this assistance, the Department has signed an assurance that it will comply with 49 CFR Part 26. The MaineDOT is responsible for determining the eligibility of and certifying DBE firms in Maine.

A DBE is defined as a for-profit business that is owned and controlled by one or more socially and economically disadvantaged person(s). For the purpose of this definition:

1. “Socially and economically disadvantaged person” means an individual who is a citizen or lawful permanent resident of the United States and who is Black, Hispanic, Native American, Asian, Female; or a member of another group or an individual found to be disadvantaged by the Small Business Administration pursuant to Section 3 of the Small Business Act.
2. “Owned and controlled” means a business which is:
 - a. A sole proprietorship legitimately owned and controlled by an individual who is a disadvantaged person.
 - b. A partnership or limited liability company in which at least 51% of the beneficial ownership interests legitimately are held by a disadvantaged person(s).
 - c. A corporation or other entity in which at least 51% of the voting interest and 51% of the beneficial ownership interests legitimately are held by a disadvantaged person(s).

The disadvantaged group owner(s) or stockholder(s) must possess control over management, interest in capital, and interest in earnings commensurate with the percentage of ownership. If the disadvantaged group ownership interests are real, substantial and continuing and not created solely to meet the requirements of this program, a firm is considered a bona fide DBE.

105.10.1.2 Commercially Useful Function MaineDOT will count expenditures of a DBE contractor toward DBE goals only if the DBE is performing a commercially useful function on that contract. A DBE performs a commercially useful function when it is responsible for execution of the work of the contract and is carrying out its responsibilities by actually performing, managing, and supervising the work involved. Credit will only be given when the DBE meets all conditions for a CUF. Credit for labor will be in accordance with the responsibilities outlined in the contract. To perform a commercially useful function, the DBE must also be responsible, with respect to materials and supplies used on the Contract, for negotiating price, determining quality and quantity, ordering the materials, and installing (where applicable) and paying for the material itself. To determine whether a DBE is performing a commercially useful function, MaineDOT will evaluate the amount of work subcontracted, industry practices, whether the amount the firm is to be paid under the Contract is commensurate with the work it is actually performing and DBE credit claimed for its performance of the work, and other relevant factors.

Rented equipment used by the DBE must not be rented from the Prime Contractor on a job that the DBE is subcontracted with that Prime Contractor for regular course of business.

A current listing of certified DBEs that may wish to participate in the highway construction program and the scope of work for which they are certified can be found at <http://www.maine.gov/mdot/disadvantaged-business-enterprises/pdf/directory.pdf>. Credit will be given for the value described by a DBE performing as:

- A. A prime contractor; 100% of actual value of work performed by own workforces.
- B. An approved subcontractor; 100% of work performed by own workforces.
- C. An owner-operator of construction equipment; 100% of expenditures committed.
- D. A manufacturer; 100% of expenditures committed. The manufacturer must be a firm that operates or maintains a factory or establishment that produces on the premises the materials or supplies obtained by the Contractor. Brokers and packagers shall not be regarded as manufacturers.
- E. A regular dealer; 60% of expenditures committed. A regular dealer is defined as a firm that owns, operates, or maintains a store, warehouse or other establishment in which the materials or supplies required for the performance of the contract are bought, kept in stock, and regularly sold to the public. For purposes of this provision a "Broker" is a DBE that has entered into a legally binding relationship to provide goods or services delivered or performed by a third party. Brokers and packagers shall not be regarded as regular dealers.
- F. A bona fide service provider; 100% of reasonable fees or commissions. Eligible services include professional, technical, consultant, or managerial, services and assistance in the procurement of essential personnel, facilities, equipment, materials or supplies required for the performance of the contract. Eligible services also include agencies providing bonding and insurance specifically required for the performance of the contract.
- G. A trucking, hauling or delivery operation. 100% of expenditures committed when trucks are owned, operated, licensed and insured by the DBE and used on the contract and, if applicable, includes the cost of the self supplied materials and supplies. 100% of expenditures committed when the DBE leases trucks from another DBE firm including an owner-operator. 100% of reasonable fees or commissions the DBE receives as a result of a lease arrangement for trucks from a non-DBE, including an owner-operator.
- H. Any combination of the above.

105.10.1.3 Race-neutral Goals The Maine DOT is required to set an annual goal (approved on a three year basis) for DBE participation in Federal-aid projects. In order to fulfill that goal, bidders are encouraged to utilize DBE businesses certified by the MaineDOT. MaineDOT seeks to meet the established DBE goal solely through race-neutral means. *Race-neutral* DBE participation occurs when a DBE is awarded a prime contract through customary competitive procurement procedures, is awarded a subcontract on a contract that does not carry a DBE contract goal, or wins a subcontract from a prime contractor that did not consider its DBE status in making the award. A DBE/subcontractor Utilization Proposed Form is required to be included in bid documents.

MaineDOT will analyze each project and create a Project Availability Target (PAT), based on a number of factors including project scope, available DBE firms, firms certified in particular project work, etc. Each bid will request that the contractor attempt to meet the PAT. This PAT is developed to assist contractors to better understand what the MaineDOT expectations are for a

specific project. The PAT is NOT a mandate but an assessment of what this particular project can bear for DBE participation. The Department anticipates that each contractor will make the best effort to reach or exceed this PAT for the project.

105.10.1.4 Race-conscious Project Goals If it is determined by the Department that the annual DBE goal will not be met through *race-neutral* means, the Department may implement *race-conscious contract goals* on some projects. Race-conscious contract goals are goals that are enforceable by the Department and require that the prime contractor use good faith effort to achieve the goal set by the Department for that particular project. If race conscious means are implemented on a project, the Prime must comply with the requirements of 49 CFR.

At the time of the bid opening, all Bidders shall submit with their bid a Disadvantaged Business Enterprise (DBE) Commitment Form provided by the Department. This form will list the DBE and non-DBE firms that are proposed to be used during the execution of the Work. The list shall show the name of the firm, the item/material/type of work involved and the dollar amount of work to be performed. The dollar total of each commitment shall be totaled and a percentage determined.

If the project goal is not met, acceptable documentation showing all good faith efforts made to obtain participation may be required in order to award the project. Failure to provide the required listing with the dollar participation total or acceptable documentation of good faith efforts to obtain DBE participation within 3 days after the bid opening date will be considered a lack of responsiveness on the part of the low bidder. Rejection of the low bid under these circumstances will require the low bidder to surrender the Proposal Guaranty to the Department. The submission and approval of the above forms does not constitute a formal subcontract.

If for any reason during the progress of the Work the Contractor finds that DBEs included on the list are unable to perform the proposed work, the Contractor, with written release by the committed DBE or approval of the Department, may substitute other DBE firms for those named on the list. If the Contractor is able to clearly document their inability to find qualified substitute firms to meet the project goal, the Contractor may request in writing approval to substitute the DBE with a non-DBE firm. If at any time during the life of the Contract it is determined that the Contractor is not fulfilling the goal or commitment(s) and is not making a good faith effort to fulfill the DBE requirement, the Department may withhold progress payments. If good faith effort is determined by the Department, failure to meet the DBE contract goal will not be a detriment to the bid award. Fulfillment of the goal percentage shall be determined by dividing the dollars committed to the DBEs by the actual contract dollars. These requirements are in addition to all other Equal Employment Opportunity requirements on Federal-aid contracts.

105.10.1.5 Certification of DBE attainment on Contracts The MaineDOT must certify that it has conducted post-award monitoring of all contracts to ensure that DBEs had done the work for which credit was claimed. The certification is for the purpose of ensuring accountability for monitoring which the regulation already requires. The MaineDOT will certify these contracts through review of CUF forms, Elations sub-contract payment tracking as well as occasional on-site reviews of projects and through the project's final closeout documentation provided by our Contracts Section.

105.10.1.6 Bidders' List Survey Pursuant to 49 CFR 26.11 the MaineDOT is required to “create and maintain” a bidders list and gather bidder information on our construction/consultant projects, Contractors will maintain information on all subcontract bids submitted by DBE and Non-DBE firms and provide that information to the Department. The Following information is required:

Firm Name

Firm Address

Firm status (DBE or non-DBE)

Age of firm (years)

And the annual gross receipts amount as indicated by defined brackets, i.e. \$500,000 to \$800,000, rather than requesting exact figures.

Not only is this information critical in determining the availability of DBE businesses relative to other businesses that do similar work, but the Federal Highway Administration requires that we obtain this information.

MaineDOT DBE Project Attainment Target (PAT)
for this Project N/A

The MaineDOT seeks to meet the specified annual Disadvantaged Business Enterprise (DBE) usage goal set out by 49 CFR 26.45 through the efforts of contractors seeking to employ qualified DBE subcontractors. We seek to meet this goal by race neutral means and do not, at this time, use contract specific requirements for each project. We do however, understand the capacity of Maine's DBE community and the unique characteristics a project may have that would differ from the broad annual goal.

Taking this into consideration, the MaineDOT will review each project and develop an anticipated attainment or Project Attainment Target (PAT) based on several factors that are project specific. Those factors include:

- Scope of Work
- DBE availability according to Specification Item
- Geographic location
- DBE capacity

This PAT is developed to assist contractors to better understand the DBE participation that the MaineDOT can reasonably expect for a specific project. The PAT is NOT a mandate but an assessment of the DBE opportunities that this project could meet or exceed. MaineDOT anticipates that each contractor will make the best effort to reach or exceed the PAT for this project.

SPECIAL PROVISION
SECTION 105
GENERAL SCOPE OF WORK
(Buy America Certification)

105.11 Federal Requirements Add the following as the third and subsequent paragraphs:

“Prior to payment by the Department, the Contractor shall provide a certification from the producer of steel or iron, or any product containing steel or iron as a component, stating that all steel or iron furnished or incorporated into the furnished product was manufactured in the United States in accordance with the requirements of the Buy America provisions of 23 CFR 635.410, as amended. Such certification shall also include (1) a statement that the iron or steel product or component was produced entirely within the United States, or (2) a statement that the iron or steel product or component was produced within the United States except for minimal quantities of foreign steel and iron valued at \$ (actual value).

All manufacturing processes must take place domestically. Manufacturing begins with the initial melting and mixing, and continues through the coating stage. Any process which modifies the chemical content, the physical size and shape, or the final finish is considered a manufacturing process. These processes include rolling, extruding, machining, bending, grinding, drilling, and coating. “Coating” includes epoxy coating, galvanizing, painting, or any other coating that protects or enhances the value of the material.

A Buy America Certification is required from each manufacturer, fabricator, supplier, subcontractor, etc. that meets the “manufacturing” definition above.

Buy America does not apply to raw materials (iron ore and alloys), scrap, pig iron, or processed, pelletized, and reduced iron ore.”

Union
24237.00
Route 17
March 2, 2022

SPECIAL PROVISION
SECTION 107
PROSECUTION & PROGRESS
(CONTRACT TIME)

The Contractor may begin work anytime in accordance with Standard Specification 104.4.2 and upon approval of all required submittals. The Contract Completion Date will be no later than **October 29th, 2022**.

Absences must be requested at least 72 hours in advance, and are subject to Department approval based on existing roadway condition, paving deadlines, adherence to schedule, traffic restrictions, detours, etc. The Contractor must assure that the roadway surface and signage are maintained for safe passage of the traveling public during any approved absences. The Contract Completion Date will not be modified due to approved absences.

Once operations commence, for every weekday not worked the Contractor will be charged supplemental liquidated damages per Section 107.7.2 of the Standard Specifications; excluding days lost to inclement weather, holidays, and approved absences.

SPECIAL PROVISION
SECTION 502
STRUCTURAL CONCRETE CULVERT INVERT LINING
(Composites Method)

Description This work shall consist of the rehabilitation (invert lining) of the culvert and the forming and placing of fish weirs inside the culvert through the use of glass fiber reinforced polymer (FRP) liner segments. The work shall include any incidental construction in accordance with these specifications as called for on the plans or as designated by the Resident. All work shall be in conformity with the Standard Specifications and other Special Provisions.

In lieu of this composites method the Contractor has the option of using a cast-in-place method for this culvert repair and construction of fish weirs. If the Contractor chooses the cast-in-place method, the appropriate special provision must be followed.

DEFINITIONS

For the purpose of this specification, the following definitions apply:

E-glass	Alumo-borosilicate glass with an alkali content of maximum one weight percent, when expressed as sodium oxide (Na ₂ O)
Effective length of unit	The distance between planes normal to the unit axis and passing through the end points of the lining unit
Liner segment	A discrete length of culvert lining which may be either a single pipe lining unit or a combined pair of segmental lining units
Vinyl ester resin	A resin produced by the esterification of an epoxy resin with an unsaturated monocarboxylic acid – the reaction product is then dissolved in a reactive solvent, such as styrene, to a 35 - 50 percent content by weight

MATERIALS

Glass Mat A layer of E-glass fiber constructed as either chopped strand mat (CSM) or continuous filament mat (CFM) that provides a resin rich FRP layer near the corrosion/erosion exposed surface. All glass fiber reinforcement shall have a surface treatment (binder) compatible with the lining manufacturing process and the matrix resins. A stitched material laminate is also acceptable.

Glass fiber Reinforcement All glass fiber reinforcement shall be E-glass or better and have a surface treatment compatible with the lining manufacturing process and the matrix resins. Unidirectional (UD) reinforcement areal weight shall not exceed 55 oz/yd² in any single ply. A layer of CSM or CFM shall separate layers of UD fabric where applicable to maintain laminar shear strength. The E-glass material shall not contain more than 0.2% moisture by weight as supplied; it shall be uncontaminated and protected to the point of use.

Grout Grout having a 28-day compressive strength of at least 3,000 psi at the desired water content for optimum placement shall be used. The permissible mixing and placement temperature range per the manufacturer's recommendations shall not be lower than 40°F or higher than 90°F. The non-shrink grout shall have a Hardened Height Change per ASTM C1090 of 0.0 to 0.3%.

Resin Vinyl ester or vinyl ester blend corrosion resistant resin shall be used with a catalyzation process applied in accordance with the resin manufacturer's instructions. The resin shall have a viscosity suitable for manufacturing method. The gel time shall be adequate for the given environmental conditions present during the manufacturing process. The gel time must allow for the elimination of wedging within the part. Resin promotion should allow for adequate cure during manufacture. Resin must achieve 80+% of manufacturer's Barcol value without post curing.

Cured resins, as cast singly without reinforcement, shall have an elongation at break greater than 1.4% when tested in accordance with ASTM D790. In addition, the Barcol Hardness as determined by ASTM D2503 shall be at least 30. Resins "flexibilized" by the addition of plasticizers shall not be used.

Coating Dyes, pigments, or additives shall be introduced as necessary in the resin to provide resistance to ultra-violet light degradation and a uniform, muted appearance.

Fasteners Carbon steel fasteners and washers with a minimum 0.2 mil zinc coating or stainless-steel fasteners and washers shall be used. Fasteners shall have a minimum shank diameter of 0.138 inches and washers shall have a diameter of between ¾ to 1 inch.

CONSTRUCTION REQUIREMENTS

General All culvert linings shall be manufactured with the following elements:

- A corrosion and abrasion resistant barrier layer
- A reinforcement layer comprised of double bias and unidirectional fabric
- A rough backing to provide a bond between the lining and annular grout
- A nailing flange that is offset from the general liner radius

The manufacturing facility shall have a Certified Composites Technician (CCT) certified in Open Molding or Vacuum Infusion Process (VIP) on staff to supervise or perform the manufacturing of all composite components. The design of the composite liner shall be completed by a composites engineer and be verified by a Professional Engineer.

Barrier Layer (BL) The BL shall be manufactured from a vinyl ester resin system reinforced with E-glass CSM or CFM between 30-50% content by weight. The BL shall be a minimum of 0.10 inches thick.

Glass reinforcement The structural layer shall be made from a vinyl ester resin system impregnated layers of E-glass fiber. At least one ply shall be double bias (± 45) stitched or woven fabric having an areal weight of at least 24 oz/yd². At least one ply shall be made up of unidirectional (UD) E-glass with the fiber direction oriented in the circumferential (hoop) direction of the liner. The areal weight of the UD plies shall be selected by analysis and/or test to satisfy strength and stiffness requirements. The structural layer shall have a fiber content of between 50%-70% by weight.

Liner fabrication Each fabric layer comprising the FRP liner shall be placed in a mold having the same nominal inner radius as the culvert minus 1 inch to avoid contact with the culvert bolts. A nailing flange shall transition outward to the nominal inner radius of the culvert extending a minimum of 2 times the number of fastener rows plus 1 inch. A gradual transition shall exist between the two liner radii extending between 3 to 6 inches depending on liner radius. The extent of the liner in the circumferential dimension shall be as shown on the Plans.

Rough backing A clean, dry aggregate shall be bonded to the back of the FRP liner to promote a mechanical bond between the liner and grout filler. It shall consist of an angular, inert material, such as crushed granite, nominally 1/8 to 1/4 inch in size uniformly distributed over the external surface. A CSM layer with an areal weight at least 1.5 oz/ft² shall be hand laid on to the back of the liner using a vinyl ester resin system and rollers to provide a resin-rich embedment layer for the aggregate. Once the resin has cured, a stiff broom shall be passed over the surface to remove any loose or poorly bonded aggregate. The aggregate must uniformly cover 50% or more of the total surface area of the back of the panel.

Weir Fabrication Weirs shall be fabricated from E-glass fabric and a vinyl ester resin system using the materials described above. The size, shape, and elevation of the weir features shall be as shown on the Plans. Wall thickness shall be at least 1/2 inch. Wall thickness may need to increase based on panel radius. Allowable stresses as per RTP1-2011.

Edges and ends The edges and ends of all trimmed lining segments and sections shall be sealed with a vinyl ester resin system to prevent the exposure of glass fibers. The resin shall be pigmented to match the color and performance of the laminating resin.

INSTALLATION

General

Flow Diversion Flow shall be rerouted or dammed prior to culvert cleaning and until after the liner, grout, and weirs have been installed. The presence of some groundwater is acceptable as long as flow is prevented along the length of the culvert. Any water propagating through the corroded invert of the culvert must be contained prior to panel installation. No grout dilution is allowable.

Cleaning and Preparation Debris shall be removed from the culvert and disposed of in accordance with state and local environmental requirements. The invert shall be pressure

washed to remove soil and loose, corroded material from the culvert. All debris should be removed by mechanical means. Any holes in the steel culvert shall be sealed with hydraulic cement. Bolts that protrude more than 1.25 inches above the crest of corrugations shall be trimmed prior to placing the FRP liner. Bolts should be cut off flush with the top of the nut. The nut must not be compromised.

All areas of culvert section loss above the composite liner shall be sandblasted and painted with a MC Zinc Primer and a MC Urethane with a Mox Tar Topcoat.

LINERS

Attachment The exact position of the first liner segment placed at one end of the culvert shall be determined based on the segment length and the overall length of the culvert such that the first and last liner segments shall be at least 5 feet long.

Liner segments shall be secured to sound steel using powder-actuated galvanized steel fasteners. The frequency and spacing of the fasteners shall be determined by engineering analysis of the seam strength requirements. Fasteners shall be driven with enough energy to ensure the head and washer are seated tight against the FRP and that contact is maintained between the FRP and steel while avoiding excess force that may cause cupping of the washer or damage to the FRP. Jacking poles may be used to hold the FRP against the steel in places where sudden geometry changes prevent contact under dead weight. The allowance of any gap between the FRP and steel is at the discretion of the engineer and shall be minimized.

Trimming Liner segments placed at the culvert ends shall be trimmed to match the taper of the existing steel culvert. The ends shall be sealed with a mixture of resin and fiber to contain the annular grout. The edges and ends of all trimmed lining segments and sections shall be sealed with a vinyl ester resin system to prevent the exposure of glass fibers. The resin shall be pigmented to match the color and performance of the laminating resin.

Joining All joining of panels shall be designed as per RTP1-2011 standards and specifications. Reference sections 3A-800 Secondary Bond Shear Stress and subpart 3B Design by Stress Analysis sections 3B-100 through 3B-700 to determine proper joint design. Refer to RTP1-2011 Mandatory Appendix M-5 Qualification of Laminators and Secondary Bonders for the required standards and practices. See section M-5 for required procedures to properly manufacture and test shear bond strength specimens.

FISH WEIRS

Size and Location The number, size, geometry, and location/elevation of all fish weirs internal and external shall be as shown on the plans.

Fitting Each fish weir shall be fabricated oversized and trimmed to fit in the required location. All trimmed edges shall be treated in accordance with the Construction Requirements above. The final weir channel elevation of the trimmed part shall be verified by the Resident prior to attachment.

Attachment The internal weirs shall be attached to the liner through the use of a methacrylate adhesive capable of bridging a gap of at least 0.250". The weir must be 100% edge sealed with the adhesive. The adhesive must be allowed to completely cure prior to installing the final weld kit. The final weld kit shall be installed on the upstream side of the weir and across the top seams on both sides. The weld kit shall be in accordance with ASME RTP-1 specifications. Glass used shall be E-glass and consist of a combination of 1.5 oz CSM and 24 oz Woven Roving. All weld kits must be final coated and leave no exposed areas.

External Fish Weirs External fish weirs should be pre-assembled on a jig and placed as a complete unit in the prepared location. The Site should be excavated to a depth as shown on the Plans to allow for the installation of a Geotextile stabilization fabric followed by a minimum of 12" of ¾" stone. The entire stone bed must be leveled to within ¼" of an inch prior to placement. The top of the stone must allow for the critical surfaces of the weirs and spouts to be at the proper final elevation.

Forming of the weirs must allow for the complete encapsulation of the weirs and spouts. Installation and placement of rebar shall be in accordance with all customer specifications. External edges must be softened to assure that there are no 90° drop offs.

QUALITY ASSURANCE

As part of the quality assurance procedures, the manufacturer shall keep records of the following against each batch of output product:

- raw material batch details, including source, acceptance test records, purchase dates and shelf-life at time of use
- resin mixing records
- initiator level
- mold pressure at commencement of infusion
- mold temperature
- resin temperature
- ambient temperature of the shop
- infusion start and stop time
- visual inspection results of the cured part
- final Barcol readings
- technician names and date of manufacture

Appearance and surface condition The surface of the lining material shall be free from tackiness and defects such as protruding fibers, air voids, crazes, cracks, blisters or foreign matter that might impair the performance in service. The internal surface of the lining shall be textured. The surface of the panels shall be finished with a pigmented UV resistant final coat. Pigment must be compatible with the resin system.

Joints The liner and joint shall be designed so that the resulting lap joint is flush with the interior surface of the liner segments. The flexible or rigid joints are required to provide a permanent seal between liner segments to protect the integrity of the grout and prevent water ingress. Rigid setting or flexible compounds used to caulk or seal the gap between liner segments shall be resistant to the environment for which they are intended, and shall be suitable for installation within a confined space taking safety aspects into consideration. Upon complete cure of the sealing compound the joint should be finished with a weld kit designed in accordance with ASME RTP-1 specifications and final coated.

Performance requirements A composites engineer shall determine the appropriate reinforcing ply thickness to satisfy all strength, stiffness, and seam strength requirements assuming the corroded invert does not provide any residual strength to the system. Mechanical testing performed by a certified (ISO 9000 or equivalent) testing laboratory shall be conducted to verify predicted material properties for final design and provide quality control data. All calculations supporting the design shall be submitted for approval by the Department prior to beginning construction.

Type tests Coupon tests to verify predicted mechanical properties used during preliminary design shall be performed before completing the detail design. These tests shall include flexural strength and modulus per ASTM D790 and compressive strength and modulus per ASTM D6641. Component level tests shall be performed to verify the predicted buckling strength of the FRP/grout system and the shear capacity of the connection. The acceptable design value for strength is the mean minus two standard deviations. The acceptable design value for modulus is the mean.

QUALITY CONTROL TESTS

General The following test requirements are necessary in order to demonstrate a continuing satisfactory level of production quality in day-to-day production. The manufacturer shall establish a quality system to meet the requirements of ISO 9001 or ASME RTP-1. Witness panels fabricated at the same time using the same materials as the liner or cut-outs from the liner segment shall be used to conduct verification tests for every tenth panel fabricated.

Dimensions Wall thickness and resin rich layer thickness shall be determined at a minimum of three locations in each test sample using a method of measurement accurate to the nearest 0.005 inches by measuring cut surfaces through the lining wall. The cut surfaces shall be smoothed sufficiently for the different layers to be delineated. Generally, the locations of cores shall include:

- A point towards the center of the test sample and points near each end of the test sample, but not at a joint.

Resin cure The surfaces shall not be tacky to the touch. Each test specimen shall be tested in accordance with the method described in ASTM D2503 at a minimum of three points and shall have a hardness not less than the minimum declared in the material subsection for resin. Post curing is permissible if necessary to achieve the desired results.

Analysis of construction The disposition of the laminates or layers and the constituents within them shall correspond to those of the type tested liners. The percentage by weight of the constituents and the weight of glass per unit area shall not deviate from the declared control values by more than $\pm 10\%$ (of each numerical value).

Appearance The internal and external surfaces of each lining unit shall be examined visually and be free from defects. Where practicable this shall occur prior to application of any bed mat backing or pigmented, UV resistant final surface coating.

Mechanical Properties The coupon tests described in 6.4 shall be conducted on test samples. The Quality Control Test results are acceptable if the calculated design values (as described in 6.4) are not less than 95% of the Type Test values.

CONTROL OF TEST CONDITIONS

Test conditions Unless otherwise required by this specification the test measurements shall be conducted at a temperature of $72 \pm 10^\circ\text{F}$ and relative humidity of $50 \pm 10\%$.

Specimen conditioning For Type Testing, specimens shall be kept in air $72 \pm 10^\circ\text{F}$ and $50 \pm 10\%$ RH for not less than 72 hours prior to testing.

For Quality Control Testing, specimens shall be kept in air at $72 \pm 10^\circ\text{F}$ and $50 \pm 10\%$ RH for not less than 24 hours after they are considered to be cured.

NOTE The preferred temperature for conditioning and testing composite materials is 72°F and 50% RH.

Test specimen preparation Test specimens shall be prepared in accordance with the applicable ASTM standards.

WORKMANSHIP, INSPECTION AND CERTIFICATION

Manufacturing Process FRP liners shall be manufactured using vacuum assisted resin transfer molding (VARTM) or open molding to ensure the production of high-quality components and repeatability of physical and mechanical properties.

All raw materials shall be tested at a frequency sufficient to ensure consistency and compliance with this specification. The manufacturer shall adequately supervise all stages of production and keep records of the raw material batches used and products made each work shift or day. Manufacture shall be under environmental conditions compatible with producing satisfactory liners and raw materials shall be stored and used in compliance with the recommendations of their manufacturers.

Reinforcement materials shall be stored in dry conditions. The liner manufacturer shall be familiar with the changes in viscosity, gel times, etc., which may occur during storage of the resin, and make appropriate allowances in the lining manufacturing process. Resin stored in original unopened containers shall not be used after the resin manufacturer's stated expiration date.

Inspection In addition to the manufacturer's own inspection and supervision, the purchaser or his appointed inspecting authority shall have access at all reasonable times to inspect parts and all relevant test records.

Certification The manufacturer shall, on request, furnish the purchaser or purchaser's representative, with copies of a signed certificate for each size of liner stating that the construction and testing of liner segments supplied comply with the requirements of this specification and given details of minimum performance parameters agreed with the purchaser. If required by the purchaser, the quality control test results or a suitable summary shall be provided with the certificate.

PROTECTION OF LINING UNITS

Liner segments shall be handled, stored and transported in such a way as to prevent damage before receipt by the purchaser.

METHOD OF MEASUREMENT

Composite invert lining and/or fish weirs satisfactorily placed and accepted in accordance with the dimensions shown on the plans, will be measured as one lump sum unit.

BASIS OF PAYMENT

The accepted structural composite invert lining and composite fish weirs inside the culvert will be paid for at the contract lump sum price under the Structural Concrete Culvert Invert Lining item. The contract lump sum price shall be full compensation for preparing surfaces, spot painting of corroded areas with a MC Zinc Primer and a MC Urethane with a Mox Tar Topcoat, placing composite segments and furnishing all other materials, equipment, labor and incidentals necessary to complete the work.

The containment and disposal of pollutants during surface preparation will not be paid for directly, but shall be incidental to the related contract item and included in the Contractor's SEWPCP.

Payment will be made under:

<u>Pay Items</u>	<u>Pay Unit</u>
502.325 Structural Concrete Culvert Invert Lining	Lump Sum

SPECIAL PROVISION
SECTION 502
STRUCTURAL CONCRETE CULVERT INVERT LINING
(Shotcrete Method)

Description This work shall consist of the rehabilitation (invert lining) of the culvert using the shotcrete method and the forming and placing of fish weirs inside of the culvert using cast-in-place concrete. The work shall include preparation of existing surfaces, installation of machine bolts or studs, spot painting of corroded areas, application by pneumatic pressure of a shotcrete mix, furnishing test panels, extracting cores, and application of asphalt emulsion as indicated on the plans, and in accordance with this specification.

The Contractor has the option of using either a cast-in-place lining method or a composite lining method for this culvert repair in lieu of this shotcrete method. If the Contractor chooses a cast-in-place or composite method, the appropriate special provision must be followed.

Shotcrete shall conform to all requirements of ACI 506.2 “Specifications for Materials, Proportioning, and Application of Shotcrete”, published by the American Concrete Institute, Detroit, Michigan, except as modified by the requirements of this project specification. Shotcrete shall consist of an application of one or more layers of mortar or concrete conveyed through a hose and pneumatically projected at a high velocity against a prepared surface.

Shotcrete shall be produced by either a dry-mix or a wet-mix process. The wet-mix process consists of thoroughly mixing all the ingredients except accelerating admixtures but including the mixing water, introducing the mixture into the delivery equipment and delivering it, by positive displacement, to the nozzle. The wet-mix shotcrete shall then be air jetted from the nozzle at high velocity onto the surface. Dry-mix process is shotcrete without mixing water which is conveyed through the hose pneumatically and the mixing water is introduced at the nozzle. For additional descriptive information, the Contractor’s attention is directed to the American Concrete Institute Standard “Guide to Shotcrete (ACI 506R-90)”.

Qualifications The work shall be performed by fully qualified personnel experienced in this type of work.

1. The foreman shall have at least five years of shotcrete experience and at least two years as a nozzleman.
2. The nozzleman shall have at least two years recent experience of satisfactory work as a nozzleman.
3. Evidence of the foreman and nozzleman’s experience of satisfactory work in similar capacities elsewhere shall be provided.

Materials All materials for shotcrete shall conform to the following requirements.

Cement	AASHTO M-85, ASTM C150, Type I, II, III or IV.
Fine Aggregate	AASHTO M-6, ASTM C33 clean, natural.

Coarse Aggregate	AASHTO M-80, Class B for quality.
Water	Potable, clean, and free from substances deleterious to concrete and steel or elements that would stain.
Chemical Admixtures	ASTM C1141 and the following:
Water-reducer	AASHTO M-194, Type A, D, F, G or
Superplasticizer	ASTM C494 Type A, D, F, G
Air-Entraining Agent	AASHTO M-194/ASTM C260
Plasticizers	AASHTO M-194 Type A, D, F, G or ASTM C494
Mineral Admixtures	
Fly Ash	AASHTO M-295, ASTM C618 Type F or C
Silica Fume	ASTM C1240, 90% minimum silicon dioxide solids content, not to exceed 12% by weight of cement. In addition, silica fume shall conform to the requirements of Section 502.
Polypropylene Fibers	ACI Standard, Polypropylene Fibers, 1 inches in length, 1½ lb/yd ³
Steel Fibers	ASTM A820 Type I, II, or III, Deformed, Steel Fibers, 1 in to 1 ¾ inches in length, minimum aspect ratio of 60.
Curing Compounds	AASHTO M-148 Type 1 D of Type 2
Pre-packaged Shotcrete	ASTM C928

The use of other admixtures shall not be used unless approved by the Resident. Admixtures used to entrain air, to reduce water-cement ratio, to retard or accelerate setting time, or to accelerate the development of strength, shall be thoroughly mixed into the shotcrete at the rate specified by the manufacturer unless specified otherwise. Accelerating additives shall be compatible with the cement used, be non-corrosive to steel and shall not promote other detrimental effects such as cracking or excessive shrinkage. The maximum allowable chloride ion content of all ingredients shall not exceed 0.10% when tested to AASHTO T260.

Premixed and pre-packaged concrete products specifically manufactured as a shotcrete product may be provided for on-site mixed shotcrete if approved by the Resident. The packages shall contain materials conforming to the materials portion of this specification.

Stud welded shear connectors or machine bolts meeting ASTM A307 shall be installed in accordance with Section 505 of the Standard Specifications with the following changes, Section 505.04 shall be ignored and the first paragraph of Section 505.05 is replaced in with the following:

Studs shall be inspected for a full 360-degree weld. Any stud that is found not to have the full weld shall be marked for re-welding.

Concrete for the internal fish weirs shall be Class "A" Concrete. The concrete mix shall include a chemical accelerator and shall be submitted to the Resident for prior approval.

Materials Storage and Handling Materials shall be delivered, stored, and handled to prevent contamination, segregation, corrosion, or damage. Liquid admixtures shall be stored to prevent evaporation and freezing.

Cement shall be adequately stored to prevent moisture degradation and partial hydration. Cement that has become caked or lumpy shall not be used.

Aggregates shall be stored so that segregation and the inclusion of foreign materials are prevented. The bottom 6 in of aggregate piles in contact with the ground shall not be used.

Submittals The following submittals shall be provided by the Contractor for the Resident's review and approval. The Contractor will not be allowed to begin culvert repairs until all submittal requirements are satisfied and found acceptable to the Resident. Changes or deviations from the approved submittals must be resubmitted for approval. Adjustments in contract time will not be allowed for incomplete submittals.

At least 21 calendar days prior to initiating the work, the Contractor shall submit to the Resident the following:

1. Written documentation of the foreman's and nozzleman's qualifications and the proposed method of shotcrete placement.
2. Shotcrete mix design including:
 - a) Brand and type of Portland Cement used.
 - b) Source, gradation, and quality of aggregates as specified herein.
 - c) Proportions of mix by weight.
 - d) Proposed admixture, manufacturer, dosage, technical literature (when admixture allowed).
 - e) Compressive strength test results from the manufacturer's records, no older than six months, verifying the 28 day compressive strength.

Shotcrete Mix Design Aggregate for shotcrete shall meet the strength and durability requirement of AASHTO M-80 and M-43 and shall meet the following gradation requirements.

<u>Sieve Size</u>	<u>% Passing by Weight</u>
3/8 in	100
No. 4	95 – 100
No. 8	80 – 100
No. 16	50 – 85
No. 30	25 – 60
No. 50	10 – 30
No. 100	2 – 10
No. 200	0-5
FM	2.3 to 3.1

- A. Proportioning Shotcrete shall be proportioned and delivered with a minimum cement content of 650 lb/yd³.

B. Strength Requirements Shotcrete shall be proportioned to produce a mix capable of attaining 5000 psi compressive strength in 28 days. The average compressive strength of each set of three cores extracted from the test panels shall equal or exceed the specified compressive strength, with no individual core less than 75 percent of the specified compressive strength, in accordance with ACI 506.2R-95.

Mixing and Batching Mixing equipment shall be capable of thoroughly mixing the materials in sufficient quantity to maintain the placing continuity. Shotcrete shall be batched, delivered and placed within 90 minutes of mixing.

Field Quality Control Production test panels shall be required. Qualified personnel shall perform shotcreting and coring of the test panels with the Department's personnel present. The Contractor shall provide equipment, materials and personnel as necessary to obtain shotcrete cores for testing including construction of test panel boxes, field curing requirements and coring. The Department will perform compressive strength testing. Shotcrete final acceptance will be based on obtaining the specified 28 day compressive strength.

Shotcreting may commence upon initial approval of the design mix and nozzlemen.

Production Test Panels At least one production test panel shall be furnished during each day of production of shotcrete. The production test panels shall be constructed simultaneously with the shotcrete facing installation at times designated by the Resident. Production test panels shall be made with the minimum dimensions of 18 x 18 inch and at least 6 inch thick.

Test Panel Curing, Test Specimen Extraction and Testing Immediately after shooting, the test panels shall be field moist cured by covering and tightly wrapping with a sheet of material meeting the requirements of ASTM C 171 until delivered to the testing lab or test specimens are extracted. The test panels shall not be immersed in water. The test panels for the first 24 hours after shooting shall not be disturbed.

At least three 3 inch diameter core samples shall be cut from each unreinforced production test panel for compressive strength testing. The Contractor shall extract the test specimens from test panels in the field within 48 hours of shooting the panel. The panels shall be kept in their forms when transported.

Cores shall not be taken from the outer 6 inch of test panels measured in from the outside edges of the panel's form.

The cores and container shall be clearly marked to identify the core locations. For production testing, the production section of the unformed superstructure repair represented by the production test panel cores shall be marked on the cores and the container. Immediately wrap cores in wet burlap or material in accordance with the requirements of ASTM C 171 and seal in a plastic bag. The Department shall take possession of the cores immediately after extraction. The remainder of the panels shall become the property of the Contractor. The Department will perform the compressive strength testing.

Upon delivery to the testing lab, samples will be placed in the moist room until the time of test. When the test length of a core is less than twice the diameter, the correction factors given in AASHTO T 24/ASTM C 42 will be applied to obtain the compressive strength of individual cores. Three cores will be tested at 28 days for compressive strength per AASHTO T 24/ASTM C 42.

Construction Requirements

Construction Requirements for the cast-in-place concrete internal fish weirs shall be in accordance with the construction requirements in Special Provision 502 Structural Concrete Culvert Invert Lining (Cast-In-Place Method).

The construction sequence shall be in accordance with the approved submittal, unless otherwise approved by the Resident.

A. Equipment

1. The shotcreting equipment selected must be capable of metering the mix through a hose to the nozzle for projecting at high velocity onto the surface to be shotcreted.
2. The gun shall be either the double chamber or the rotary type capable of continuous delivery of material. Gaskets in the equipment must be kept in good condition to avoid reduced pressure and consequent reduced velocity of material through the hose.
3. The air compressor may be any standard type capable of sufficient pressures and volume of air to convey the material through the longest hose delivery. The air compressor capacity must have allowance for air used in removing rebound and other incidental work. The air hose shall be equipped with filters to prevent any oil or grease from contaminating the shotcrete.
4. Water pressure shall be maintained at a minimum 15 psi higher than the highest air pressure required for placing the material. Both air and water pressure shall be uniformly steady.

- B. Surface Preparation The Contractor shall remove all loose materials, rust, scale, oil, and deleterious material from all surfaces to receive shotcrete by methods acceptable to the Resident. The removal shall be accomplished in such a manner as not to loosen, crack, or shatter the surfaces to receive the shotcrete. Any surface material, which in the opinion of the Resident, is so loosened or damaged shall be removed to a sufficient depth to provide a base that is suitable to receive the shotcrete. The Contractor shall clean all surfaces to receive shotcrete by methods acceptable to the Resident. Material that loosens as the shotcrete is applied shall be removed. No shotcrete shall be placed on frozen surfaces.

All areas of section loss above the concrete liner shall be sandblasted and painted with a MC Zinc Primer and a MC Urethane with Mox Tar Topcoat.

- C. Shotcrete Alignment Control The Contractor shall ensure that the thickness of shotcrete satisfies the minimum thickness shown on the design drawings using alignment wires, thickness control pins, or other means acceptable to the Resident.
- D. Delivery and Application In the areas of the culvert, where voids are present a preliminary placement of shotcrete shall be made to fill all voids adjacent to the extremity of the lines of the structure face. The final placement is to be made over this preliminary placement to full depth.

The shotcrete shall be applied from the lower part of the work area upwards to prevent accumulation of rebound on uncovered surfaces. Rebound shall not be worked back into the placement nor shall the rebound be salvaged. Rebound which does not fall clear of the working area shall be removed. The nozzle shall be held at an angle approximately perpendicular to the working face and at a distance so that rebound will be minimal and compaction will be maximized. Thickness, methods of support, air pressure, and rate of placement of shotcrete shall be controlled to prevent sagging or sloughing of freshly applied shotcrete.

The shotcreting procedure may be corrected by adjusting the nozzle distance and orientation perpendicular to the surface, adjusting the water content of the shotcrete mix or other means acceptable to the Resident. Retempering of the mix will not be permitted. The shotcreted surface shall be broomed and roughened to insure proper bond of subsequent layers.

All horizontal edges of exposed concrete (joint between the top of the concrete invert lining and the corrugated metal culvert) shall be sealed with an asphalt emulsion (roofing tar) which extends onto the culvert at least 1 in.

- E. Defective Shotcrete Surface defects shall be repaired as soon as possible after initial placement of the shotcrete. All shotcrete which lacks uniformity, which exhibits segregation, sagging, honeycombing, or lamination, or which contains any voids of sand pockets shall be removed and replaced with fresh shotcrete by the Contractor in accordance with this specification and to the satisfaction of the Resident.

A clearly defined pattern of continuous horizontal or vertical ridges or depressions at the reinforcing elements after they are covered will be considered an indication of insufficient cover of reinforcement or poor application and probable void. In this case, the application of shotcrete shall be immediately suspended and the work carefully inspected by the Resident. The Contractor shall implement and complete corrective measures prior to resuming the shotcrete operations.

Reinforcement All reinforcement shall be secured in place to prevent displacement during the shotcrete application.

- F. Finish Shotcrete finish shall be a natural gun finish. Scraping or cutting to remove high spots shall not be done until the shotcrete has become stiff enough to withstand the pull of the cutting device.
- G. Weather Limitations Shotcrete shall not be placed without cold weather protection when the ambient temperature is below 40° F and falling and/or when the shotcrete is likely to be subjected to freezing temperatures before a minimum strength of 700 psi. Cold weather protection shall be maintained until the strength of the in-place shotcrete is greater than 750 psi. Cold weather protection shall include heating under tents, blankets, or other means acceptable to the Resident. The temperature of the shotcrete, when deposited, shall be above 50° F but less than 90° F.

Shotcrete application shall also be suspended during high winds and heavy rains when, in the opinion of the Resident, the quality of the application is not acceptable. Newly placed shotcrete exposed to rain that washes out cement or otherwise makes the shotcrete unacceptable to the Resident shall be removed and replaced. The Contractor shall provide adequately secured polyethylene sheeting or equivalent when adverse exposure to weather is anticipated.

- H. Curing An approved curing cover (or compound) shall be applied within 18 hours after finishing. After surface water has evaporated from the finished surface, shotcrete exposed to sunlight shall be immediately treated for curing. Finished shotcrete shall be cured for a minimum of 48 hours before flushed with water, unless otherwise directed by the Resident, and flush water must be collected as per Section 656.

Safety Requirements Appropriate eye and dust protection equipment shall be used during shotcrete application. Cement and other admixtures are caustic and may cause eye, skin, and respiratory irritation unless safety measures are taken. Adequate ventilation shall be required. Nozzlemen and helpers shall as a minimum be equipped with gloves, respirators, eye protection and adequate protective clothing during the application of shotcrete. The Contractor is responsible for meeting all Federal, State, and Local Safety Code Requirements.

Method of Measurement The shotcrete for the culvert invert lining and fish weirs, satisfactorily placed and accepted in accordance with the dimensions shown on the plans, will be measured as one lump sum unit.

Basis of Payment The accepted shotcrete for the culvert invert lining and the reinforced concrete fish weirs inside the culvert will be paid for at the contract lump sum price for Structural Concrete Culvert Invert Lining. The contract lump sum price shall be full compensation for preparing surfaces, installing machine bolts or studs, spot painting of corroded areas with an Zinc rich Primer and MC Urethane with a Mox Tar Topcoat, applying shotcrete, forming and placing concrete, applying of asphalt emulsion, constructing test panels, extracting cores, and furnishing all materials, equipment, labor, and incidentals necessary to complete the work. Reinforcing steel fabrication, delivery and placing shall be paid for under their respective pay items.

Shotcrete and concrete admixtures including silica fume will not be paid for directly, but shall be incidental to the related contract item.

The containment and disposal of pollutants during surface preparation and during shotcrete application will not be paid for directly, but shall be incidental to the related contract item and included in the Contractor's SEWPCP.

Payment will be made under:

<u>Pay Item</u>		<u>Pay Unit</u>
502.325	Structural Concrete Culvert Invert Lining	Lump Sum

SPECIAL PROVISION
SECTION 502
STRUCTURAL CONCRETE CULVERT INVERT LINING
(Cast-In-Place Method)

Description This work shall consist of the rehabilitation (invert lining) of the culvert and the forming and placing of fish weirs inside of the culvert through the use of cast-in-place concrete. The work shall include preparation of existing surfaces, installation of machine bolts or studs, spot painting of corroded areas, placement of concrete, the application of emulsified asphalt and any incidental construction in accordance with these specifications as called for on the plans or as designated by the Resident. All work shall be in conformity with the Standard Specifications and other Special Provisions.

In lieu of this cast-in-place method the Contractor has the option of using a composites method for this culvert repair and construction of fish weirs. If the Contractor chooses the composite method, the appropriate special provision must be followed.

Materials Concrete for the culvert repair shall be Class "A" Concrete. The concrete mix shall include a chemical accelerator and shall be submitted to the Resident for prior approval.

Construction Requirements All work shall be in conformity with applicable requirements of Section 502.

Stud welded shear connectors or machine bolts meeting ASTM A307 shall be installed in accordance with Section 505 of the Standard Specifications with the following changes, Section 505.04 shall be ignored and the first paragraph of Section 505.05 is replaced in with the following:

Studs shall be inspected for a full 360-degree weld. Any stud that is found not to have the full weld shall be marked for re-welding.

All reinforcement shall be secured in place to prevent displacement during the concrete placement.

Finish the entire length of the invert with a broom surface finish.

The horizontal interfaces (joint between the top of the concrete invert lining and the corrugated metal culvert) shall be sealed with an asphalt emulsion (roofing tar) which extends onto the metal culvert at least 25 mm [1 in].

All areas of steel section loss above the concrete liner shall be sandblasted and painted with a MC Zinc Primer and a MC Urethane with Mox Tar Topcoat.

The Contractor shall sandblast all areas from 25 mm [1 in] below the top of concrete lining to 150 mm [6 in] below lowest row of shear connectors. The Contractor shall remove all loose

materials, rust, scale, oil and deleterious material from all remaining surfaces to receive concrete by methods acceptable to the Resident. In areas where the metal is non-existent, a preliminary concrete placement shall be made utilizing forms where required, to fill voids and establish the former extremity lines of the metal. The final placement is to be made over this preliminary placement. No concrete shall be placed on frozen surfaces.

An approved curing cover (or compound) shall be applied within 18 hours after finishing. Finished concrete shall be cured for a minimum of 48 hours before flushed with water, unless otherwise directed by the Resident, and flush water must be collected as per Section 656.

Method of Measurement The structural concrete for the culvert invert lining, including the fish weirs, satisfactorily placed and accepted in accordance with the dimensions shown on the plans, will be measured as one lump sum unit.

Basis of Payment The accepted structural concrete for the culvert invert lining and fish weirs inside the culvert will be paid for at the contract lump sum price for Structural Concrete Culvert Invert Lining. The contract lump sum price shall be full compensation for preparing surfaces, installing machine bolts or studs, spot painting of corroded areas with an MC Zinc Primer and MC Urethane with a Mox Tar Topcoat, placing concrete, applying of asphalt emulsion and furnishing all materials except reinforcing steel, equipment, labor and incidentals necessary to complete the work. Reinforcing steel fabrication, delivery and placing shall be paid for under their respective pay items.

Concrete admixtures including silica fume will not be paid for directly, but shall be incidental to the related contract item.

The containment and disposal of pollutants during surface preparation will not be paid for directly, but shall be incidental to the related contract item and included in the Contractor's SEWPCP.

Payment will be made under:

<u>Pay Item</u>	<u>Pay Unit</u>
502.325 Structural Concrete Culvert Invert Lining	Lump Sum

SPECIAL PROVISION
SECTION 502
STRUCTURAL CONCRETE
(Fish Weirs)

Description This work shall consist of forming and placing reinforced concrete fish weirs outside the culvert and any incidental construction in accordance with these specifications as called for on the plans or as designated by the Resident. All work shall be in conformity with the Standard Specifications and other Special Provisions.

Materials Concrete shall be Class A using Testing Method C; Reinforcing Steel shall be ASTM A615/A615M Grade 60.

CONSTRUCTION REQUIREMENTS

General The fish weir(s), including the vertical walls and channel bottom for the entire length between the weirs as shown on the plans shall be formed, cast, and stripped in the conventional manner; the use of shotcrete will not be allowed for construction of the external fish weir structure.

Method of Measurement Reinforced concrete fish weirs satisfactorily placed and accepted will be measured for payment as one lump sum unit acceptably covered in accordance with the plans and this special provision.

Basis of Payment Reinforced concrete fish weirs will be paid for at the contract lump sum price. Payment shall be full compensation for forming, placing and finishing the concrete; fabrication, all equipment and labor, and all other incidentals necessary to complete the work. Reinforcing steel fabrication, delivery and placing shall be paid for under their respective pay items.

Payment will be made under:

<u>Pay Item</u>	<u>Pay Unit</u>
502.326 Structural Concrete Fish Weirs	Lump Sum

SPECIAL PROVISION
SECTION 502
PUMPED GROUT

Description This work shall consist of providing and placing non-shrink grout as described below. The void space underneath the existing culvert shall be completely grouted to support the culvert and provide long-term stability of the surrounding fill. The Contractor shall provide testing of the materials and methods for compliance with the following requirements. The work shall be done in accordance with the plans, this specification or as directed by the Resident.

Preparation Grouting shall be done at regions of the culvert specified by the Resident. Prior to grouting, venting shall be constructed. Holes for grouting shall be drilled in the bottom of existing culvert at a grid spacing between 4 and 6 feet. If the identified region(s) are close to the end of the culvert, bulkheading of the ends shall be constructed as directed by the Resident.

Materials The grout material shall consist of portland cement (portland cement and fly ash) and/or additives as described in the following Subsections of Division 700 - Materials:

Portland Cement	701.01
Water	701.02
Air-Entraining Admixtures	701.03
Fine Aggregate	701.01
Fly Ash	701.10 Type F or C
Chemical Admixtures	701.04
Accelerating Admixtures	AASHTO M-194 Type "C"

(a) Compressive Strength The grout shall have a minimum compressive strength of 4000 psi in 28 days.

(b) Performance Requirements The Contractor shall submit the proposed grout mix, methods, plans and criteria of the grouting operations. The grouting system shall have sufficient gauges, monitoring devices and tests to determine the effectiveness of the grouting operation

Acceptance of the concrete will be based on Method C Verification. All concrete grout placed underwater shall contain an approved anti-washout admixture from the Department's Qualified Products List.

Qualifications The Contractor shall demonstrate to the Resident its worker's capabilities of filling the void space and performing their work in conformance with the Plans and the Specifications.

Grouting Equipment The materials shall be mixed in equipment of sufficient size and capacity to provide the desired amount of grout material for each stage in a single operation. The equipment shall be capable of mixing the grout at densities required for the approved procedure and shall also be capable of changing density as dictated by field conditions any time during the grouting operation.

Injection Procedure and Pressure The Contractor shall use a low pump pressure and have no delays in placing of the grout. Pumping equipment shall be of a size sufficient to inject grout an appropriate velocity and pressure relative to the size of the void space. The Contractor needs to monitor the culvert to prevent deformations of the culvert during grouting operations. Any repairs for permanent deformations or cracks resulting from the grouting work shall be at the Contractor's expense.

Curing The grout shall cure for a minimum of 24 hours with the temperature maintained between 45⁰ and 90⁰ degrees.

Submittals and Required Calculations The Contractor shall submit the following to the Resident for his review and approval at least 30 working days prior to the start of the grouting operation:

- (1) The proposed grouting mix
- (2) The proposed densities and viscosities
- (3) Initial set time of the grout
- (4) The proposed grouting method
- (5) The maximum injection pressure
- (6) The 24-hour and 28 day compressive strengths

The Contractor shall notify the Resident of any changes to be made in grouting.

Method of Measurement Pumped grout shall be measured by the cubic yard of concrete grout delivered and successfully placed. The concrete grout shall be measured to the nearest 0.1 cubic yard.

Basis of Payment The accepted work done under Pumped Grout will be paid for at the contract unit price per cubic yard. Payment will be full compensation for furnishing and placing flowable fill including all forms, berms, bulkheads, pumping, and incidents necessary.

Payment will be made under:

<u>Pay Item</u>	<u>Pay Unit</u>
502.2483 Pumped Grout	Cubic Yard

SPECIAL PROVISION
SECTION 502
STRUCTURAL CONCRETE
(QC/QA Acceptance Methods)

CLASS OF CONCRETE	ITEM NUMBER	DESCRIPTION	P	METHOD
A	All	All Class A concrete	-	C

SPECIAL PROVISION
SECTION 524
TEMPORARY STRUCTURAL SUPPORTS
(Embankment Support)

Standard Specification Section 524 is amended as follows:

524.01 Description

The following sentence is added:

This work shall consist of designing, fabricating, erecting, maintaining, and dismantling a temporary structural support wall(s) for the purpose of supporting the roadway embankment during construction.

524.03 Design

The following sentence is added:

The design for the temporary structural support shall be submitted to the Resident at least 3 weeks prior to construction.

524.06 Basis of Payment

Replace the subsection in its entirety with the following:

The temporary structural support will be paid for at the Contract lump sum price which shall be full compensation for all materials, equipment, labor, and incidentals necessary for the design, erection, maintenance, dismantling, and removal of all supports required to build the bridge in stages, in accordance with these specifications.

Payments will be made under:

<u>Pay Item</u>	<u>Pay Unit</u>
524.301 Temporary Structural Support	Lump Sum

SPECIAL PROVISION
SECTION 652
MAINTENANCE OF TRAFFIC

Approaches. Approach signing shall include the following signs at a minimum. Field conditions may warrant the use of additional signs as determined by the Resident.

Road Work Next X* Miles
Road Work 500 Feet (Ahead)
End Road Work

Work Areas. At each work site, signs and channelizing devices shall be used as directed by the Resident.

Signs include:

Road Work xxxx¹.
One Lane Road Ahead
Flagger Sign

Other typical signs include:

Be Prepared to Stop
Low Shoulder
Bump
Pavement Ends

The above lists of Approach signs and Work Area signs are representative of the contract requirements. Other sign legends may be required.

Unless otherwise defined in Special Provision 105/107 or submitted and approved in the Traffic Control Plan, the following shall apply:

- The Contractor shall conduct their operations in such a manner that the roadway will not be restricted to one lane for more than 2,500 feet at each work area and no more than 4,000 feet for paving and milling work areas.
- Where more than one work area restricts traffic to one lane operation, these work areas shall be separated by at least 1 mile of two-way operation.

Temporary Centerline A temporary centerline shall be placed each day on all new pavement to be used by traffic. The temporary centerline, when specified of reflectorized traffic paint, shall conform to the standard marking patterns used for permanent markings. Failure to apply a temporary centerline daily will result in a Traffic Control Violation and suspension of paving operations until temporary markers are applied to all previously placed pavement.

¹ “Road Work Ahead” to be used in short duration operations and “Road Work xx feet” to be used in stationary operations as directed by the Resident.

2020 STANDARD DETAIL UPDATES

Standard Details and Standard Detail updates are available at:
<http://maine.gov/mdot/contractors/publications/standarddetail/>

<u>Detail #</u>	<u>Description</u>	<u>Revision Date</u>
502(19)	Bridge Drains	12/08/2021
507(20)	Steel Approach Railing 3-Bar	2/11/2021
507(21)	Steel Approach Railing 3-Bar	2/11/2021
507(22)	Steel Approach Railing 3-Bar	2/11/2021
507(23)	Steel Approach Railing 3-Bar	2/11/2021
507(27)	Steel Approach Railing	2/11/2021
526(01)	Portable Concrete Barrier	1/14/2021
526(01A)	Portable Concrete Barrier	1/14/2021
526(01B)	Portable Concrete Barrier	1/14/2021
526(02)	Portable Concrete Barrier	1/14/2021
526(02A)	Portable Concrete Barrier	1/14/2021
526(03)	Portable Concrete Barrier	1/14/2021
526(04)	Portable Concrete Barrier	1/14/2021
526(04A)	Portable Concrete Barrier	1/14/2021
526(04B)	Portable Concrete Barrier	1/14/2021
603(10)	Concrete Pipe Ties	6/10/2021
605(01)	Underdrain	8/13/2021
606(23)	Standard Bridge Transition – Type “1”	2/11/2021
606(24)	Standard Bridge Transition – Type “1A”	2/11/2021
608(02)	Detectable Warnings	6/10/2021
609(09)	Precast Concrete Vertical Curb	2/11/2021
627(07)	Crosswalk	2/22/2022
627(08)	Crosswalk	2/22/2022
643(11)	ATCC Cabinet	12/14/2020
801(11)	Pedestrian Ramp Notes	6/10/2021
801(12)	Pedestrian Ramp Requirements	8/13/2021
801(13)	Ramp Length Table	6/10/2021
801(14)	Parallel Pedestrian Ramp	6/10/2021
801(15)	Perpendicular Pedestrian Ramp – Option 1	6/10/2021

801(16)	Parallel Pedestrian Ramp – Option 2A	6/10/2021
801(17)	Perpendicular Pedestrian Ramp – Option 2A	6/10/2021
801(18)	Parallel Pedestrian Ramp – Option 2B	6/10/2021
801(19)	Perpendicular Pedestrian Ramp – Option 2B	6/10/2021
801(20)	Parallel Pedestrian Ramp – Option 3	6/10/2021
801(21)	Perpendicular Pedestrian Ramp – Option 3	6/10/2021
801(22)	Side Street Pedestrian Ramp	6/10/2021
801(23)	Parallel Pedestrian Ramp – Esplanade	6/10/2021
801(24)	Perpendicular Pedestrian Ramp – Esplanade	6/10/2021
801(25)	Island Crossings	6/10/2021
801(26)	Blended Transition	6/10/2021
801(27)	Pedestrian Ramp Adjacent to Driveway or Entrance	6/10/2021
802(05)	Roadway Culvert End Slope Treatment	1/03/2017

SUPPLEMENTAL SPECIFICATIONS
(Corrections, Additions, & Revisions to Standard Specifications – March 2020)

SECTION 101
CONTRACT INTERPRETATION

101.2 Definitions

Holidays Amend this paragraph by adding “**Juneteenth**” between ‘Memorial Day’ and ‘Independence Day’.

SECTION 102
BIDDING

102.11 Bid Responsiveness Revise the paragraph that states
“The Bid is not signed by a duly authorized representative of the Bidder.” So that it reads:

“The Bid is not signed by a duly authorized representative of the Bidder.

- **Properly submitted electronic bids meet this requirement.**
- **Paper bids must include at least one signed copy of the Contract Agreement Offer & Award form.”**

SECTION 104
GENERAL RIGHTS AND RESPONSIBILITIES

104.2.1 Furnishing of Right-of-Way Revise the last sentence in the first paragraph by removing “105.4.5 – Special Detours” and replacing it with “**105.4.5 – Maintenance of Existing Structures.**”.

SECTION 105
GENERAL SCOPE OF WORK

105.10.2 Requirements Applicable to All Contracts Under section A, number 2, in the first sentence of the first paragraph, revise this Section by replacing the word “handicap” in two places with the word “disability” so it now reads:

“2) The Contractor will, in all solicitations or advertisements for employees placed by or on behalf of the Contractor, State that all qualified applicants will receive consideration for employment without regard to race, color, sexual orientation, religious creed, sex, national origin, ancestry, age, physical disability, or mental disability.”

SECTION 106
QUALITY

106.6 Acceptance Revise this Subsection by replacing the paragraph beginning with “Acceptance of Hot Mix Asphalt Pavement will be based” with:

“Acceptance of Hot Mix Asphalt Pavement will be based on Method A or C Statistical Acceptance, or Method B or D Acceptance as specified. The method of acceptance for each item is defined in Special Provision, Section 403, Hot Mix Asphalt Pavement. When items of Hot Mix Asphalt Pavement are not so designated, Method A will be utilized whenever there are more than 1000 tons per Hot Mix Asphalt Pavement item, and Method B will be utilized when there are less than or equal to 1000 tons per Hot Mix Asphalt Pavement item.”

Revise Subsection “B” by removing it and replacing it with:

“B. Items not designated for Statistical Acceptance will utilize Method B or D Acceptance testing to validate the quality of the material incorporated into the Project. For material paid under Item 403.209 – Method D, or designated to be visually accepted, the Contractor shall provide the Department with a Certification Letter that indicates that the material supplied complies with the Specifications. Test results representative of the certified material shall be attached to the letter.

The Department will randomly sample and test the certified Material for properties noted in Table 1 of Section 502 - Structural Concrete or Table 14 of Section –401.21 Acceptance Method B & D. Material will be subject to rejection as noted in Structural Concrete Section 502.195 - Quality Assurance Method C Concrete or Hot Mix Asphalt, Section 401.2022 Pay Adjustment – Method B & D.”

106.7.1 Standard Deviation Method Revise 106.7.1, subsection H by removing the following from the first paragraph:

“Method B: $PF = [70 + (\text{Quality Level} * 0.33)] * 0.01$ ”

SECTION 107 TIME

107.3.1 General Amend this paragraph by adding “**Juneteenth**” between ‘Patriot’s Day’ and ‘the Friday after Thanksgiving’.

SECTION 110 INDEMNIFICATION, BONDING, AND INSURANCE

110.3.9 Administrative & General Provisions Amend this subsection by adding “**Automobile Liability**” under letter A) Additional Insured to the list of exceptions.

SECTION 206
STRUCTURAL EXCAVATION

206.01 Description – *Structural Earth Excavation, Below Grade* delete the entire sentence and replace with “**shall consist of the removal of excavation required for unknown or unanticipated subsurface condition. See 206.04 – Method of Measurement for pay limits.**”

206.04 Method of Measurement – Drainage and Minor Structures Paragraph 1, sentence 2, delete the remainder of the sentence beginning with “...provided the maximum allowable...”

And replace with: “...in accordance with the following limits:”

- **Vertical pay limits:**
 - **Below a plane parallel with and 12 inches below the bottom of the drainage or minor structure or**
 - **Below the excavation limits shown in the Bid Documents; whichever is greater.**

- **Horizontal pay limits** – **The maximum allowable horizontal dimensions shall not exceed those bounded by vertical surfaces 18 inches outside the base, or extreme limits of, the structure, and to the vertical neat lines of underdrain trenches, as shown in the Contract Documents.**

SECTION 401
HOT MIX ASPHALT PAVEMENT

401.19 Contractor Quality Control Amend this Section by adding the following to the end:
“**Failure to comply with the approved QCP will result in work suspension and pay reductions as outlined in Section 106.4.6. The Quality Control Plan Value shall be the total bid value for all items covered by the QCP as identified in Special Provision 403.**”

SECTION 502
STRUCTURAL CONCRETE

502.09 Forms and Falsework Amend this subsection by adding the subsection title “**502.10 Placing Concrete**” after section “D” Removal of Forms and False work” and after the paragraph beginning with “2. Forms and False work, including blocking...”. So that a new subsection starts and reads:

“**502.10 Placing Concrete**

A. **General Concrete shall not be placed until forms”**

502.1701 Quality Control, Method A and B Revise this Section so that the first paragraph and the first sentence of the second paragraph read:

502.17 Quality Control The Contractor shall control the quality of the concrete through testing, inspection, and practices which shall be described in the QCP, sufficient to assure a product meeting the Contract requirements. The QCP shall meet the requirements of Section 106, Quality, and this specification. No work under this item shall proceed until the QCP is submitted to and approved by the Department. Failure to comply with the approved QCP will result in work suspension and pay reductions as outlined in Section 106.4.6. The Quality Control Plan Value shall be the total bid value for all cast-in-place items covered by the QCP, using the P value listed in Special Provision 502. If no P value is listed, a value of \$350, or bid value per cubic yard, whichever is less, shall be used.

502.1701 Quality Control, Method A and B The QCP shall address all elements that affect the quality of the structural concrete including, but not limited to, the following: “

502.18, Method of Measurement, Revise Subsection ‘F’ by removing the word ‘transverse’ so that it reads: “Saw cut grooving of concrete wearing surfaces, complete and accepted, will be measured for payment as one lump sum.”

502.19, Basis of Payment, Revise the third paragraph by removing the word ‘transverse’ so that it reads: “Saw cut grooving of concrete wearing surfaces will be paid for at the Contract Lump Sum Price, which shall be payment for furnishing all materials, labor, and equipment, including depth gauges and all incidentals, to satisfactorily complete the work.”

(Also see 535.24 and 535.25 for related changes)

SECTION 503 REINFORCING STEEL

Section 503.07 Splicing Revise this section by removing the table and following footnote and replacing them with:

Minimum Lap Splice Length (inches)									
Bar Type	Bar Size								
	#3	#4	#5	#6	#7	#8	#9	#10	#11
Plain or Galvanized	16	20	24	29	38	47	59	72	85
Epoxy or Dual Coated	17	24	36	43	56	71	88	107	128
Stainless	19	24	30	36	47	59	73	89	107
Low-carbon Chromium	24	32	39	47	63	78	97	119	142

“The minimum lap splice lengths in the table above are based on the parameters below. When any of these parameters are altered, appropriate minimum lap splice lengths will be as shown on the Plans.

- Normal weight concrete
- Minimum 28-day concrete compressive strength from 4,000 psi to 10,000 psi

- **Class B tension lap splice**
- **Minimum center-to-center spacing between bars of 6 inches**
- **Minimum clear cover of 2 inches**
- **Nominal reinforcing steel yield strengths**
 - **Low-carbon Chromium = 100 ksi**
 - **Stainless = 75 ksi**
 - **All others = 60 ksi**
- **Reinforcement with yield strengths greater than 75 ksi shall have beam transverse reinforcement and column ties provided over the required lap splice length in accordance with the current edition of the AASHTO LRFD Bridge Design Specifications**

When lap splices are placed horizontally in an element where the concrete depth below the splice will be 12 inches, or more, the indicated lap splice lengths shall be multiplied by a factor of 1.3.”

SECTION 506 SHOP APPLIED PROTECTIVE COATING – STEEL

506.13 Surface Preparation Amend this section by adding this paragraph to the end:

“Steel shall meet the requirements of SSPC SP8 Pickling prior to being immersed in the zinc tanks. Verification of the surface preparation shall be included in the QC documentation.”

SECTION 523 BEARINGS

523.051 Protective Coating Revise this subsection by removing the paragraph beginning with “Anchor rods shall be galvanized...” and replacing with:

“Anchor rods shall be galvanized. When anchor rods are designated to secure bare unpainted steel or painted steel, a dielectric coating (epoxy or bituminous type coatings are acceptable) shall be applied to the anchor rod and/or adjacent steel to prevent contact between galvanized surfaces and painted or unpainted steel.”

523.22 Fabrication Amend this subsection by adding the following: **“Elastomeric Bearings shall be fabricated in accordance with AASHTO M251.”**

SECTION 526 CONCRETE BARRIER

Amend this section by deleting it in its entirety and replacing it with:

“526.01 Description This work shall consist of the furnishing, constructing, erecting, setting, resetting, and removal of concrete barrier and associated elements in accordance with these specifications, the Standard Details, and the lines and grades shown on the Plans or established by the Resident.

The types of concrete barrier are designated as follows:

Portable Concrete Barrier Type I Double faced removable barrier in accordance with the Standard Details.

Permanent Concrete Barrier Type II Double faced barrier as shown on the Plans.

Permanent Concrete Barrier Type IIIa Single faced barrier 32 inches high in accordance with the Standard Details or as shown on the Plans.

Permanent Concrete Barrier Type IIIb Single faced barrier 42 inches high in accordance with the Standard Details or as shown on the Plans.

Permanent Concrete Transition Barrier Barrier of various heights joining steel bridge rail to steel guardrail in accordance with the Standard Details or as shown on the Plans.

Permanent Texas Classic Rail Barrier Traffic rail or sidewalk rail, in accordance with the Standard Details or as shown on the Plans.

526.02 Materials

a. **Concrete** Concrete for barriers, both permanent and portable, shall have a design strength of 5,000 psi.

For cast-in-place barrier: The concrete shall be Class LP, in accordance with Standard Specification Section 502, Structural Concrete.

For precast barrier: The concrete shall meet the requirements of Standard Specification 712.061, Structural Precast Concrete Units, except that the stripping strength for precast barriers is 4,000 psi.

b. **Reinforcing Steel** Reinforcing steel shall meet the requirements of Section 503, Reinforcing Steel.

c. **Structural Steel** Plates and barrier connections shall meet the requirements specified in Standard Specification 504 - Structural Steel and shall be hot dip galvanized after fabrication in accordance with Standard Specification 506, Shop Applied Protective Coating – Steel

d. **Bolts** Bolts shall meet the requirements specified in Section 713.02, High Strength Bolts.

e. Connecting Pins for Portable Concrete Barrier Portable concrete barriers must be connected using a 1- inch diameter pin. The connecting pin must be smooth, not deformed, i.e., reinforcing bar may not be used, and shall meet the strength requirements of ASTM A449 steel. Materials with greater strength may be used with the approval of the Department.

f. Anchor Pins for Portable Concrete Barrier Anchoring to concrete or asphalt will be required when specified on the Plans. When required, portable concrete barriers must be anchored using a 1 ½ - inch diameter anchor pin. The anchor pin must be smooth, not deformed, i.e., reinforcing bar may not be used, and shall meet the strength requirements of ASTM A36 steel. Materials with greater strength may be used with the approval of the Department.

g. Device Crashworthiness MaineDOT is transitioning to MASH2016 criteria for Portable Concrete Barrier on the following schedule:

New Portable Concrete Barrier shall be crash tested and/or evaluated to MASH2016 criteria.

Current Portable Concrete Barrier in useful serviceable condition that is successfully tested to NCHRP Report 350 or MASH2009 criteria may be utilized through December 31, 2029.

Other current Portable Concrete Barrier that is deemed acceptable by the Department may be utilized on projects off the National Highway System through December 31, 2024.

526.03 Construction Requirements

Cast-in-place barriers shall be fabricated in accordance with Standard Specification Section 502, Structural Concrete. Precast barriers shall be fabricated in accordance with Standard Specification 534, Precast Structural Concrete.

Concrete finish for permanent barrier shall be rubbed as defined in Standard Specification Section 502, Structural Concrete, 502.13 D2 or an approved equal.

Portable concrete barrier shall be generally free from fins and porous areas and shall present a neat and uniform appearance.

Permanent barrier shall have a protective coating applied in accordance with Standard Specification Section 515, Protective Coating for Concrete Surfaces.

Reflective delineators for concrete median barrier shall meet the requirements of Special Provision 645, Highway Signing.

Preformed Joint Filler shall meet the requirements specified in Subsection 705.01, Preformed Expansion Joint Filler.

Permissible dimensional tolerances for all concrete barriers shall be as follows:

- a. Cross-sectional dimensions shall not vary from design dimensions by more than ¼ inch. The vertical centerline shall not be out of plumb by more than ¼ inch.**
- b. Longitudinal dimensions shall not vary from the design dimensions by more than ¼ inch per 10 feet of barrier section and shall not exceed ¾ inches per section.**
- c. Location of anchoring holes shall not vary by more than ½ inch from the dimensions shown in the concrete barrier details on the Plans.**
- d. Surface straightness shall not vary more than ¼ inch under a 10-foot straightedge.**
- e. The barrier shall have no significant cracking. Significant cracking is defined as fractures or cracks passing through the section, or any continuous crack extending for a length of 12 inches or more, regardless of position in the section.** **526.04 Method of Measurement** **Permanent Concrete Barrier Type II, IIIa, IIIb, Texas Classic Rail, and Precast Median Barrier will be measured for payment by lump sum, complete in place.**

Portable concrete barrier, both anchored and unanchored will be measured for payment by lump sum. Lump sum measurement will include verification of the installation and removal of all portable concrete at the completion of the Contractor's operations.

The Contractor shall replace sections of portable concrete barrier, including anchored barrier damaged by the traveling public when directed by the Resident. Replacement sections will be measured for payment in accordance with Standard Specification 109.7, Equitable Adjustments to Compensation and Time.

Transition barrier will be measured by each, complete in place.

526.05 Basis of Payment The accepted quantities of Concrete Barrier Type II, IIIa, IIIb, Texas Classic Rail, and Precast Median Barrier will be paid for at the Contract lump sum price for the type specified, complete in place.

The accepted quantities of Portable Concrete Barrier Type I, both anchored and unanchored will be paid for at the Contract lump sum price. Such payment shall be full compensation for furnishing all materials, assembling, moving, resetting, transporting, temporarily storing, removing barrier, furnishing new parts as necessary, and all incidentals necessary to complete the work.

Portable barrier shall become the property of the Contractor upon completion of the use of the barrier on the project and shall be removed from the project site by the Contractor.

Transition barrier will be paid for at the Contract price each, complete in place.

The accepted quantity of all types of concrete barrier, whether portable or permanent, will be paid for at the lump sum or per each price, as applicable, which payment shall be full compensation for all materials, including reinforcing steel, protective coating, reflective delineators, steel plates and hardware, equipment, labor and incidentals required, as necessary, to complete the work.

Payment will be made under:

	<u>Pay Item</u>	<u>Pay Unit</u>
526.301	Portable Concrete Barrier, Type I	Lump Sum
526.304	Portable Concrete Barrier, Anchored Type I	Lump Sum
526.312	Permanent Concrete Barrier Type II	Lump Sum
526.321	Permanent Concrete Barrier Type IIIa	Lump Sum
526.323	Texas Classic Rail	Lump Sum
526.331	Permanent Concrete Barrier Type IIIb	Lump Sum
526.34	Permanent Concrete Transition Barrier	Each
526.502	Precast Concrete Median Barrier	Lump Sum”

SECTION 527 ENERGY ABSORBING UNIT

527.02 Materials Amend this section by deleting it in its entirety and replacing it with:

“MaineDOT is transitioning to MASH2016 criteria for Work Zone Traffic Control Devices on the following schedule:

Portable Crash Cushions will be crash tested and/or evaluated to MASH2016 criteria by January 1, 2030. Current Category 3 devices in useful serviceable condition that are successfully tested to NCHRP Report 350 or MASH2009 criteria may be utilized through December 31, 2029.

Work Zone Crash Cushions shall be selected from the Department’s Qualified Products List of Crash Cushions/Impact Attenuators or approved equal.”

SECTION 535 PRECAST, PRESTRESSED CONCRETE SUPESTRUCTURE

535.24, Installation of Slabs, Beams, and Girders Revise the 5th paragraph by replacing “6.0 and 9.0” to “5.0 and 8.0” so it reads: **“Ready mixed grout shall achieve a design compressive strength of 6,000 psi at 28 days, have an entrained air content of between 5.0 and 8.0 percent, be non-shrink, flowable, and contain a non-shrink additive listed on the Department QPL for expansive cements.”**

535.25, Installation of Precast/Prestressed Deck Panels Revise the 2nd paragraph by replacing “6.0 and 9.0” to “5.0 and 8.0” so it reads: **“Ready mixed grout shall achieve a design compressive strength of 6,000 psi at 28 days, have an entrained air content of between 5.0 and 8.0 percent, be non-shrink, flowable, and contain a non-shrink additive listed on the Department QPL for expansive cements.”**

SECTION 606 GUARDRAIL

Amend this section by replacing it with the following:

606.01 Description This work shall consist of furnishing and installing guardrail components in accordance with these specifications and in reasonably close conformity with the lines and grades shown on the plans or as established. Guardrail is designated as:

31” W-Beam Guardrail - Mid-Way Splice

Galvanized steel w-beam, 8” wood or composite offset blocks, galvanized steel posts

Thrie Beam

Galvanized steel thrie beam, 8” wood or composite offset blocks, galvanized steel posts

Median guardrail shall consist of two beams of the above types, mounted on single posts.

Bridge mounted guardrail shall consist of furnishing all labor, materials, and equipment necessary to install guardrail as shown on the plans. This work shall also include drilling for and installation of offset blocks if specified, and incidental hardware necessary for satisfactory completion of the work.

Remove and Reset and Remove, Modify, and Reset guardrail shall consist of removing the existing designated guardrail and resetting in a new location as shown on the plans or directed by the Resident. Remove, Modify, and Reset guardrail and Modify guardrail include the following guardrail modifications: Removing plate washers at all posts, except at anchorage assemblies as noted on the Standard Details, adding offset blocks, and other modifications as listed in the Construction Notes or General Notes. Modifications shall conform to the guardrail Standard Details.

Bridge Connection shall consist of the installation and attachment of beam guardrail to the existing bridge. This work shall consist of constructing a concrete end post or modifying an existing end post as required, furnishing, and installing a terminal connector, necessary hardware, and incidentals required to complete the work as shown on the plans. Bridge Transition shall consist of a bridge connection and furnishing and installing guardrail components as shown in the Standard Details.

606.02 Materials Materials shall meet the requirements specified in the following Sections of Division 700 - Materials:

Timber Preservative	708.05
Metal Beam Rail	710.04
Guardrail Posts	710.07
Guardrail Hardware	710.08

Guardrail components shall meet the applicable standards of "A Guide to Standardized Highway Barrier Hardware" prepared and approved by the AASHTO-AGC-ARTBA Joint Cooperative Committee, Task Force 13 Report.

Posts for underdrain delineators shall be "U" channel steel, 8 ft long, 2 ½ lb/ft minimum and have 3/8-inch round holes, 1-inch center to center for a minimum distance of 2 ft from the top of the post.

Reflectorized Flexible Guardrail Markers shall be mounted on all guardrails. A marker shall be mounted onto guardrail posts at the flared guardrail terminal end point and tangent point, both at the leading and trailing ends of each run of guardrail. The marker's flexible posts shall be gray with either silver-white or yellow reflectors (to match the edge line striping) at the tangents, red at leading ends, and green at trailing ends. Whenever the guardrail terminal is not flared, markers will only be required at the terminal end point. These shall be red or green as appropriate. Markers shall be installed on the protected side of guardrail posts unless otherwise approved by the Resident. Reflectorized flexible guardrail markers shall be from the Department's Qualified Products List of Delineators. The marker shall be gray, flexible, durable, and of a non-discoloring material to which 3-inch by 9-inch reflectors shall be applied, and capable of recovering from repeated impacts and meeting MASH 16 requirements. Reflective material shall meet the requirements of Section 719.01 for ASTM D 4956 Type III reflective sheeting. The marker shall be secured to the guardrail post with two fasteners, as shown in the Standard Details.

Reflectorized beam guardrail ("butterfly"-type) delineators shall be mounted on all "w"-beam guardrail. The delineators shall be mounted within the guardrail beam at guardrail posts. Delineators shall be fabricated from high-impact, ultraviolet & weather resistant thermoplastic. Reflectorized beam guardrail delineators shall be placed at approximately 62.5 ft intervals or every tenth post on tangents and at approximately 31.25 ft intervals or every fifth post on curves. Exact locations of the delineators shall be as directed by the Resident. On divided highways, the left-hand delineators shall be yellow, and the right-hand delineators shall be silver/white. On two directional highways, the right-hand side shall be silver/white, and no reflectorized delineator used on the left. All reflectors shall have reflective sheeting applied to only one side of the delineator facing the direction of traffic as shown in the Standard Details. Reflectorized sheeting for guardrail delineators shall meet the requirements of Section 719.01.

Single wood post shall be of cedar, white oak, or tamarack, well-seasoned, straight, and sound and have been cut from live trees. The outer and inner bark shall be removed, and all knots trimmed flush with the surface of the post. Posts shall be uniform taper and free of kinks and bends.

Single steel post shall conform to the requirements of Section 710.07 b.

Single steel pipe post shall be galvanized, seamless steel pipe conforming to the requirements of ASTM A120, Schedule No. 40, Standard Weight.

Acceptable multiple mailbox assemblies shall be listed on the Department's Qualified Products List and shall be MASH 16 tested and approved.

Flared and Tangent w-beam guardrail terminals and guardrail offset blocks shall be from the Department's Qualified Products List. Flared terminals shall be installed with a 4 ft offset as shown in the Manufacturer's installation instructions.

Anchorage assemblies used to anchor trailing ends, radius guardrail, or other ends not exposed to traffic shall meet the applicable standards of "A Guide to Standardized Highway Barrier Hardware" prepared and approved by the AASHTO-AGC-ARTBA Joint Cooperative Committee, Task Force 13 Report, Drawing SEW02a.

Existing materials damaged or lost during adjusting, removing and resetting, or removing, modifying, and resetting, shall be replaced by the Contractor without additional compensation. Existing guardrail posts and guardrail beams found to be unfit for reuse shall be replaced when directed by the Resident.

606.03 Posts Posts for guardrail shall be set plumb in holes or they may be driven if suitable driving equipment is used to prevent battering and distorting the post. When posts are driven through pavement, the damaged area around the post shall be repaired with approved bituminous patching. Damage to lighting and signal conduit and conductors shall be repaired by the Contractor.

When set in holes, posts shall be on a stable foundation and the space around the posts, backfilled in layers with suitable material, thoroughly tamped.

The reflectorized flexible guardrail markers shall be set plumb with the reflective surface facing the oncoming traffic. Markers shall be installed on the protected side of guardrail posts. Markers, which become bent or otherwise damaged, shall be removed and replaced with new markers.

Single wood posts shall be set plumb in holes and backfilled in layers with suitable material, thoroughly tamped. The Resident will designate the elevation and shape of the top. The posts, that are not pressure treated, shall be painted two coats of good quality oil base exterior house paint.

Single steel posts shall be set plumb in holes as specified for single wood posts or they may be driven if suitable driving equipment is used to prevent battering and distorting the post.

Additional bolt holes required in existing posts shall be drilled or punched, but the size of the holes shall not exceed the dimensions given in the Standard Details. Metal around the holes shall be thoroughly cleaned and painted with two coats of approved aluminum rust resistant paint. Holes shall not be burned.

606.04 Rails Brackets and fittings shall be placed and fastened as shown on the plans. Rail beams shall be erected and aligned to provide a smooth, continuous barrier. Beams shall be lapped with the exposed end away from approaching traffic.

End assemblies shall be installed as shown on the plans and shall be securely attached to the rail section and end post.

All bolts shall be of sufficient length to extend beyond the nuts but not more than ½ inch. Nuts shall be drawn tight.

Additional bolt holes required in existing beams shall be drilled or punched, but the size of the holes shall not exceed the dimensions given in the Standard Details. Metal around the holes shall be thoroughly cleaned and painted with two coats of approved aluminum rust resistant paint. Holes shall not be burned.

606.045 Offset Blocks The same offset block material is to be provided for the entire project unless otherwise specified.

606.05 Shoulder Widening At designated locations the existing shoulder of the roadway shall be widened as shown on the plans. All grading, paving, seeding, and other necessary work shall be in accordance with the Specifications for the type work being done.

606.06 Mail Box Post Single wood post shall be installed at the designated location for the support of the mailbox. The multiple mailbox assemblies shall be installed at the designated location in accordance with the Standard Details and as recommended by the Manufacturer. Attachment of the mailbox to the post will be the responsibility of the home or business owner.

606.07 Abraded Surfaces All galvanized surfaces of new guardrail and posts, which have been abraded so that the base metal is exposed, and the threaded portions of all fittings and fasteners and cut ends of bolts shall be cleaned and painted with two coats of approved rust resistant paint.

606.08 Method of Measurement Guardrail will be measured by the linear foot from center to center of end posts along the gradient of the rail except where end connections are made to masonry or steel structures, in which case measurement will be as shown on the plans. When connected to radius rail, measurement will be to the end of the last tangent beam.

Guardrail terminal, reflectorized flexible guardrail marker, terminal end, anchorage assembly, bridge transition, bridge connection, multiple mailbox post, and single post will be measured by each unit of the kind specified and installed.

Widened shoulder will be measured as a unit of grading within the limits shown on the plans.

Excavation in solid rock for placement of posts will be paid under force account unless otherwise indicated in the Bid Documents.

606.09 Basis of Payment The accepted quantities of guardrail will be paid for at the contract unit price per linear foot for the type specified, complete in place. Reflectorized beam guardrail (“butterfly”-type) delineators will not be paid for directly but will be considered incidental to guardrail items. Reflectorized flexible guardrail marker, terminal end, anchorage assembly, bridge transition, bridge connection, multiple mailbox post, and single post will be paid for at the contract unit price each for the kind specified complete in place.

Guardrail terminals will be paid for at the contract price each, complete in place which price shall be full payment for furnishing and installing all components including the terminal section, posts, offset blocks, "w" beam, cable foundation posts, plates and for all incidentals necessary to complete the installation within the limits as shown on the Standard Details or the Manufacturer's installation instructions. Pay limits for a flared terminal will be 37.5 feet. Pay limits for a tangent terminal will be 50 feet. Each guardrail terminal will be clearly marked with the Manufacturer's name and model number to facilitate any future needed repair. Such payment shall also be full compensation for furnishing all material, excavating, backfilling holes, assembling, and all incidentals necessary to complete the work, except that for excavation for posts or anchorages in solid ledge rock, payment will be made under 109.7.5 – Force Account. Type III Retroreflective Adhesive Sheeting shall be applied to the approach buffer end sections and sized to substantially cover the end section. On all roadways, the ends shall be marked with alternating black and retroreflective yellow stripes. The stripes shall be 3 in wide and sloped down at an angle of 45 degrees toward the side on which traffic is to pass the end section. Guardrail terminals shall also include a set of installation drawings supplied to the Resident.

Anchorage to bridge end posts will be part of the bridge work. Connections thereto will be considered included in the unit bid price for guardrail.

Guardrail to be placed on a radius of curvature of 150 ft or less will be paid for under the designated radius pay item for the type guardrail being placed.

Widened shoulder will be paid for at the contract unit price each complete in place and will be full compensation for furnishing and placing, grading and compaction of aggregate subbase and any required fill material.

Adjust guardrail will be paid for at the contract unit price per linear foot and will be full compensation for adjusting to grade. Payment shall also include adjusting guardrail terminals where required.

Modify guardrail will be paid for at the contract unit price per linear foot and will be full compensation for furnishing and installing offset blocks, additional posts, and other specified modifications; removing, modifying, installing, and adjusting to grade existing posts and beams; removing plate washers and backup plates, and all incidentals necessary to complete the work. Payment shall also include removing and resetting guardrail terminals where required.

Remove and Reset guardrail will be paid for at the contract unit price per linear foot and will be full compensation for removing, transporting, storing, reassembling all parts, necessary cutting, furnishing new parts when necessary, reinstalling at the new location, and all other incidentals necessary to complete the work. Payment shall also include removing and resetting guardrail terminals when required.

Remove, Modify, and Reset guardrail will be paid for at the contract unit price per foot and will be full compensation for the requirements listed in Modify guardrail and Remove and Reset guardrail.

Bridge Connections will be paid for at the contract unit price each. Payment shall include, attaching the connection to the endpost including furnishing and placing concrete and reinforcing steel

necessary to construct new endposts if required, furnishing and installing the terminal connector, and all miscellaneous hardware, labor, equipment, and incidentals necessary to complete the work.

Bridge Transitions will be paid for at the contract unit price each. Payment shall include furnishing and installing the thrie beam or “w”-beam terminal connector, doubled beam section, and transition section, where called for, posts, hardware, precast concrete transition curb, and any other necessary materials and labor, including the bridge connection as stated in the previous paragraph.

No payment will be made for guardrail removed, but not reset and all costs for such removal shall be considered incidental to the various contract pay items.

Payment will be made under:

<u>Pay Item</u>	<u>Pay Unit</u>
606.1301 31” W-Beam Guardrail - Mid-Way Splice – Single Faced	Linear Foot
606.1302 31” W-Beam Guardrail - Mid-Way Splice – Double Faced	Linear Foot
606.1303 31” W-Beam Guardrail - Mid-Way Splice, 15’ Radius and Less	Linear Foot
606.1304 31” W-Beam Guardrail - Mid-Way Splice, Over 15’ Radius	Linear Foot
606.1305 31” W-Beam Guardrail - Mid-Way Splice Flared Terminal	Each
606.1306 31” W-Beam Guardrail - Mid-Way Splice Tangent Terminal	Each
606.1307 Bridge Transition (Asymmetrical) – Type IA	Each
606.1721 Bridge Transition - Type I	Each
606.1722 Bridge Transition - Type II	Each
606.1731 Bridge Connection - Type I	Each
606.1732 Bridge Connection - Type II	Each
606.178 Guardrail Beam	Linear Foot
606.25 Terminal Connector	Each
606.257 Terminal Connector - Thrie Beam	Each
606.259 Anchorage Assembly	Each
606.265 Terminal End-Single Rail - Galvanized Steel	Each
606.266 Terminal End-Single Rail - Corrosion Resistant Steel	Each
606.275 Terminal End-Double Rail - Galvanized Steel	Each
606.276 Terminal End-Double Rail - Corrosion Resistant Steel	Each
606.353 Reflectorized Flexible Guardrail Marker	Each
606.354 Remove and Reset Reflectorized Flexible Guardrail Marker	Each
606.356 Underdrain Delineator Post	Each
606.358 Guardrail, Modify	Linear Foot
606.362 Guardrail, Adjust	Linear Foot
606.365 Guardrail, Remove, Modify, and Reset	Linear Foot
606.366 Guardrail, Remove and Reset	Linear Foot
606.367 Replace Unusable Existing Guardrail Posts	Each
606.47 Single Wood Post	Each
606.48 Single Galvanized Steel Post	Each

606.50	Single Steel Pipe Post	Each
606.51	Multiple Mailbox Support	Each
606.568	Guardrail, Modify - Double Rail	Linear Foot
606.63	Thrie Beam Rail Beam	Linear Foot
606.64	Guardrail Thrie Beam - Double Rail	Linear Foot
606.65	Guardrail Thrie Beam - Single Rail	Linear Foot
606.66	Terminal End Thrie Beam	Each
606.70	Transition Section - Thrie Beam	Each
606.71	Guardrail Thrie Beam - 15 ft radius and less	Linear Foot
606.72	Guardrail Thrie Beam - over 15 ft radius	Linear Foot
606.73	Guardrail Thrie Beam - Single Rail Bridge Mounted	Linear Foot
606.74	Guardrail - Single Rail Bridge Mounted	Linear Foot
606.753	Widen Shoulder for Low Volume Guardrail End	Each
606.754	Widen Shoulder for Flared Guardrail Terminal	Each
606.78	Low Volume Guardrail End	Each
606.80	Buried-in-Slope Guardrail End	Each

SECTION 608 SIDEWALKS

Section 608.022 Detectable Warning Materials Standard Revise this section by removing the last sentence of this section beginning with “Concrete...” and replacing it with “**Concrete shall meet the requirements of Section 608.021, Sidewalk Materials, of this specification or may be a prepackaged concrete mix from the Department’s Qualified Products List (QPL).**”

SECTION 609 CURB

609.02 Materials Revise the paragraph beginning “The Contractor shall submit a concrete mix...” so that it reads:

“The Contractor shall submit a concrete mix design for the Portland Cement Concrete to the Resident, with a minimum designed compressive strength of 3000 psi concrete fill.”

609.03 Vertical Stone Curb, Terminal Section and Transition Sections and Portland Cement Concrete Curb, Terminal Sections and Transition Sections Revise this section by underlining the section number and title so that it reads in the spec book as:

“609.03 Vertical Stone Curb, Terminal Section and Transition Sections and Portland Cement Concrete Curb, Terminal Sections and Transition Sections”

Revise the last paragraph beginning with “The Contractor may elect...” so that it reads:

“The Contractor may elect to substitute concrete to backfill Stone Curbing or Stone Edging at their option. If the concrete backfill option is elected, the Concrete Fill shall meet the requirements of 609.02. The Contractor shall submit a concrete design for the Portland Cement Concrete, with a minimum designated compressive strength of 3000 PSI meeting the requirements of Class S or Class Fill Concrete. The Contractor may elect to choose a Prepackaged Concrete Mix from the Department’s Qualified Products list (QPL). Concrete backfill shall be completed in conformance with a Department supplied concrete backfill detail.”

SECTION 610

STONE FILL, RIPRAP, STONE BLANKET, AND STONE DITCH PROTECTION

610.02 Materials Amend this subsection by adding the following to the end of the material list:
“Stone Ditch Protection 703.29”

SECTION 618

SEEDING

618.08 Mulching Revise this Section so that the third sentence reads: “Mulch for Seeding Method Number 1 shall only be cellulous fiber mulch Section 619.04 (b) or straw mulch Section 619.04 (a).”

SECTION 619

MULCH

619.03 General Amend this Section by adding the following sentence to the end: **“Straw mulch shall be used in all wetland areas.”**

SECTION 626

FOUNDATIONS, CONDUIT, AND JUNCTION BOXES FOR HIGHWAY SIGNING, LIGHTING, AND SIGNALS

Section 626.021 Miscellaneous Materials Revise this section by removing the fourth paragraph beginning with “ All Concrete for concrete encasement...” and replace it with **“All concrete for concrete encasement of conduit shall be Class S or Class Fill concrete in accordance with the applicable requirements of Section 502 – Structural Concrete, or a Prepackaged Concrete Mix from the Department’s Qualified Products List (QPL).”**

Section 626.031 Conduit Revise the fifth paragraph beginning with “After the trench has been...” by removing the last sentence beginning with “Where concrete encasement...” and replacing it with **“Where concrete encasement is required around the conduit, the concrete shall meet Class S, Class Fill in accordance with the applicable requirements of Section 502 – Structural Concrete, or a Prepackaged Concrete Mix from the Department’s Qualified Products List (QPL).”**

626.034 Concrete Foundations Revise this Section by changing ‘626.037’ to ‘**626.036**’ in the Second Paragraph which begins with “Foundations shall consist of cast-in-place...”.

Revise the 10th paragraph beginning with “Before placing concrete, the required elbows...” by removing “...in accordance with **Standard Specification 633.**”

626.036 Precast Foundations Revise the last sentence of paragraph one so that it reads: **“Construction of precast foundations shall conform to the Standard Details and all requirements of 712.061.”**

SECTION 627 PAVEMENT MARKINGS

627.06 Application Revise this subsection by replacing the paragraph beginning with “ On other final pavement markings...” with the following:

“On other final pavement markings and on curb, where the paint is applied by hand painting or spraying, application shall be one uniform covering coat at least 16 mils thick. Before the paint has dried, the glass beads shall be applied by a pressure system that will force the glass beads onto the undried paint as uniformly as possible.

Painted lines and markings shall be applied in accordance with the manufacturer’s published recommendations. These recommendations will be supplied to the Resident prior to installation.”

SECTION 643 TRAFFIC SIGNALS

643.021 Materials Amend this subsection by adding the following at the end:

“MaineDOT is transitioning to MASH2016 criteria for Work Zone Traffic Control Devices on the following schedule:

Temporary Traffic Control Signals will be crash tested and/or evaluated to MASH2016 criteria by January 1, 2030. Current Category 4 devices in useful serviceable condition that are successfully tested to NCHRP Report 350 or MASH2009 criteria may be utilized through December 31, 2029.”

643.09 Service Connection Revise this subsection by removing the paragraph that begins with “Traffic signal services shall have...”.

And by removing the paragraphs beginning with “ A service ground rod shall be installed...” and “A total of 4, 10’ service...” and replace them with **“A total of 4, 10’ service ground rods shall be installed and properly connected together on the outside of the cabinet foundation. One ground rod shall be located at each corner and shall be either flush or slightly below finished grade. The connection between the ground rod and the ground wire shall be an**

exothermic connection such as a Cadweld. The ground wire from the interconnected ground rods shall be routed through a conduit in the foundation and into the base of the cabinet”.

SECTION 645 HIGHWAY SIGNING

Section 645.023 Sign Support Structures. Under letter “c.”, revise the fifth paragraph beginning with “In addition to the required details...” by removing the words **”and foundation”** from the 5th sentence.

Section 645.08 Method of Measurement. Revise the second paragraph beginning with “Bridge-type, cantilever and...” by removing the words **”including the foundation”** .

Section 645.09 Basis of Payment. Revise the third paragraph beginning with “The accepted bridge-type, cantilever and...” by removing the word **”foundation”** from the second sentence. Add the following sentence to the end of the paragraph **“Conduits, Junction Boxes, and Foundations will be paid for under Section 626.”**

SECTION 652 MAINTENANCE OF TRAFFIC

Amend this Section by adding the following new subsection:

“652.2.6 Device Crashworthiness MaineDOT is transitioning to MASH2016 criteria for Work Zone Traffic Control Devices on the following schedule:

Category 1 (Cones, Drums, Tubular Markers, Flexible Delineators, and similar devices that have little chance of causing windshield penetration, tire damage, or other significant effect on the control or trajectory of a vehicle) – All Category 1 devices will be manufacturer self-certified as MASH2016 by January 1, 2025. Current Category 1 devices in useful serviceable condition that are not self-certified as MASH2016 compliant may be utilized through December 31, 2024.

Category 2 (Barricades, Portable Sign Supports, Category 1 devices with attachments, and similar devices that are not expected to produce significant vehicular velocity change but may be otherwise hazardous) – All Category 2 devices will be crash tested and/or evaluated to MASH2016 criteria by January 1, 2025. Current Category 2 devices in useful serviceable condition that are successfully tested to NCHRP Report 350 or MASH2009 criteria may be utilized through December 31, 2024.

Category 3 (Portable Concrete Barrier, Portable Crash Cushions, Truck Mounted Attenuators, Category 2 devices weighing more than 100 pounds, and similar devices that are expected to produce significant vehicular velocity change or other harmful reactions) – All Category 3 devices will be crash tested and/or evaluated to MASH2016 criteria by January 1, 2030. Current Category 3 devices in useful serviceable condition that are successfully tested to

NCHRP Report 350 or MASH2009 criteria may be utilized through December 31, 2029. (See Standard Specification 526 for additional Portable Concrete Barrier information).

Category 4 (Trailer Mounted Devices: Arrow Boards, Temporary Traffic Control Signals, Area Lighting, Portable Changeable Message Sign, and other similar devices.) – All Category 4 devices will be crash tested and/or evaluated to MASH2016 criteria by January 1, 2030. Current Category 4 devices in useful serviceable condition that are successfully tested to NCHRP Report 350 or MASH2009 criteria may be utilized through December 31, 2029.”

652.4 Flaggers Revise the first paragraph of this section so that it reads:

“The Contractor shall furnish flaggers as required by the TCP or as otherwise specified by the Resident. All flaggers must have successfully completed a flagger test approved by the Department and administered by a Department-approved Flagger-Certifier who is employing that flagger. All flaggers must carry an official certification card with them while flagging that has been issued by their employer.”

SECTION 681

PRECAST AGGREGATE-FILLED, CONCRETE BLOCK GRAVITY WALL

681.08 Basis of Payment Amend this section by adding the Item Number “**681.10**” in front of the item “Precast Aggregate-Filled Concrete Block Gravity Wall” at the end of the section.

SECTION 703

AGGREGATES

Add the following to Section 703 - Aggregates

703.01 Fine Aggregate for Concrete Fine aggregate for concrete shall consist of natural sand or, when approved by the Resident, other inert materials with similar characteristics or combinations thereof, having strong, durable particles. Fine aggregate from different sources of supply shall not be mixed or stored in the same pile nor used alternately in the same class of construction or mix without permission of the Resident.

All fine aggregate shall be free from injurious amounts of organic impurities. Should the fine aggregate, when subjected to the colorimetric test for organic impurities, AASHTO T 21, produce a color darker than the reference standard color solution (laboratory designation Plate III), the fine aggregate shall be rejected.

Fine aggregate shall have a sand equivalent value of not less than 75 when tested in accordance with AASHTO T 176.

Fine aggregate sources shall meet the Alkali Silica Reactivity (ASR) requirements of Section 703.0201.

The fineness modulus shall not be less than 2.26 or more than 3.14. If this value is exceeded, the fine aggregate will be rejected unless suitable adjustments are made in proportions of coarse and fine

aggregate. The fineness modulus of fine aggregate shall be determined by adding the cumulative percentages of material by weight retained on the following sieves: Nos. 4, 8, 16, 30, 50, 100 and dividing by 100.

Fine aggregate, from an individual source when tested for absorption as specified in AASHTO T 84, shall show an absorption of not more than 2.3 percent.

Sieve Designation	Percentage by Weight Passing Square Mesh Sieves
$\frac{3}{8}$ inch	100
No. 4	95-100
No. 8	80-100
No. 16	50-85
No. 30	25-60
No. 50	10-30
No. 100	2-10
No. 200	0-5.0

703.02 Coarse Aggregate for Concrete Coarse aggregate for concrete shall consist of crushed stone or gravel having hard, strong, durable pieces, free from adherent coatings and of which the composite blend retained on the $\frac{3}{8}$ inch sieve shall contain no more than 15 percent, by weight of flat and elongated particles when performed in accordance with test method ASTM D 4791, Flat Particles, Elongated Particles, or Flat and Elongated Particles in Coarse Aggregate, using a dimensional ratio of 1:5.

The coarse aggregate from an individual source shall have an absorption no greater than 2.0 percent by weight determined in accordance with AASHTO T 85 modified for weight of sample.

The composite blend shall have a Micro-Deval value of 18.0 percent or less as determined by AASHTO T 327 or not exceed 40 percent loss as determined by AASHTO T 96.

Coarse aggregate sources shall meet the Alkali Silica Reactivity (ASR) requirements of Section 703.0201.

Coarse aggregate shall conform to the requirements of the following table for the size or sizes designated and shall be well graded between the limits specified.

Sieve Designation	Percentage by Weight Passing Square Mesh Sieves			
	A	AA	S	LATEX
Grading	1 inch	¾ inch	1½ inch	½ inch
Aggregate Size	1 inch	¾ inch	1½ inch	½ inch
2 inch			100	
1½ inch	100		95-100	
1 inch	95-100	100	-	
¾ inch	-	90-100	35-70	100
½ inch	25-60	-	-	90-100
⅜ inch	-	20-55	10-30	40-70
No. 4	0-10	0-10	0-5	0-15
No. 8	0-5	0-5	-	0-5
No. 16	-	-	-	-
No. 50	-	-	-	-
No. 200	0 - 1.5	0 - 1.5	0 - 1.5	0 - 1.5

703.0201 Alkali Silica Reactive Aggregates All coarse and fine aggregates proposed for use in concrete shall be tested for Alkali Silica Reactivity (ASR) potential under AASHTO T 303 (ASTM C 1260), Accelerated Detection of Potentially Deleterious Expansion of Mortar Bars Due to Alkali-Silica Reaction, prior to being accepted for use. Acceptance will be based on testing performed by an accredited independent lab submitted to the Department. Aggregate submittals will be required on a 5-year cycle, unless the source or character of the aggregate in question has changed within 5 years from the last test date.

As per AASHTO T 303 (ASTM C 1260): Use of a particular coarse or fine aggregate will be allowed with no restrictions when the mortar bars made with this aggregate expand less than or equal to 0.10 percent at 30 days from casting. Use of a particular coarse or fine aggregate will be classified as potentially reactive when the mortar bars made with this aggregate expand greater than 0.10 percent at 30 days from casting. Use of this aggregate will only be allowed with the use of cement-pozzolan blends and/or chemical admixtures that result in mortar bar expansion of less than 0.10 percent at 30 days from casting as tested under ASTM C 1567.

Acceptable pozzolans and chemical admixtures that may be used when an aggregate is classified as potentially reactive include, but are not limited to the following:

- a. Class F Coal Fly Ash meeting the requirements of AASHTO M 295
- b. Ground Granulated Blast Furnace Slag (Grade 100 or 120) meeting the requirements of AASHTO M 302
- c. Densified Silica Fume meeting the requirements of AASHTO M 307
- d. Lithium-based admixtures
- e. Metakaolin

Pozzolans or chemical admixtures required to offset the effects of potentially reactive aggregates will be incorporated into the concrete at no additional cost to the Department.

703.05 Aggregate for Sand Leveling Aggregate for sand leveling shall be sand of hard durable particles free from vegetable matter, lumps or balls of clay and other deleterious substances. The aggregate shall meet the grading requirements of the following table.

Sieve Designation	Percentage by Weight Passing Square Mesh Sieves	
	Type A	Type B
3/8 inch	85-100	
No. 200	0-5.0	

703.06 Aggregate for Base and Subbase The following shall apply to Sections (a.) and (c.) below. The material shall have a Micro-Deval value of 25.0 or less as determined by AASHTO T 327. If the Micro-Deval value exceeds 25.0, the Washington State Degradation DOT Test Method T113, Method of Test for Determination of Degradation Value (January 2009 version) shall be performed, except that the test shall be performed on the portion of the sample that passes the 1/2 inch sieve and is retained on the No. 10 sieve. If the material has a Washington Degradation value of less than 15, the material shall be rejected.

The material used in Section (b.) below shall have a Micro-Deval value of 25.0 or less as determined by AASHTO T 327. If the Micro-Deval value exceeds 25.0 the material may be used if it does not exceed 25 percent loss on AASHTO T 96, Resistance to Degradation of Small-Size Coarse Aggregate by Abrasion and Impact in the Los Angeles Machine.

Recycled Asphalt Pavement (RAP) shall not be used for or blended with aggregate base or subbase.

- a. Aggregate for base, Type A and B shall be crushed ledge or crushed gravel of hard durable particles free from vegetable matter, lumps or balls of clay and other deleterious substances. The gradation of the part that passes a 3 inch sieve shall meet the grading requirements of the following table:

Sieve Designation	Percentage by Weight Passing Square Mesh Sieves	
	Type A	Type B
1/2 inch	45-70	35-75
1/4 inch	30-55	25-60
No. 40	0-20	0-25
No. 200	0-6.0	0-6.0

At least 50 percent by weight of the material retained on the No. 4 sieve shall have at least one fractured face as tested by AASHTO T 335.

Type A aggregate for base shall only contain particles of rock that will pass the 2 inch square mesh sieve.

Type B aggregate for base shall only contain particles of rock that will pass the 4 inch square mesh sieve.

- b. Aggregate for base, Type C shall be crushed ledge or crushed gravel of hard durable particles free from vegetable matter, lumps or balls of clay and other deleterious substances. The material shall meet the grading requirements of the following table:

Sieve Designation	Percentage by Weight Passing Square Mesh Sieves	
	Type C	
4 inches	100	
3 inches	90-100	
2 inches	75-100	
1 inch	50-80	
½ inch	30-60	
No. 4	15-40	
No. 200	0-6.0	

At least 50 percent by weight of the material coarser than the No. 4 sieve shall have at least one fractured face as tested by AASHTO T 335.

- c. Aggregate for subbase shall be sand or gravel of hard durable particles free from vegetable matter, lumps or balls of clay and other deleterious substances. The gradation of the part that passes a 3 inch sieve shall meet the grading requirements of the following table:

Sieve Designation	Percentage by Weight Passing Square Mesh Sieves	
	Type D	Type E
½ in	35-80	
¼ inch	25-65	25-100
No. 40	0-30	0-50
No. 200	0-7.0	0-7.0

Type D aggregate for subbase gravel may contain up to 50 percent by weight Recycled Concrete Aggregate (RCA). When RCA is used, the portion of the resulting blend of gravel and RCA retained on a ½” square mesh sieve shall contain a total of no more than 5 percent by weight of other recycled materials such as brick, concrete masonry block, or asphalt pavement as determined by visual inspection.

RCA shall be substantially free of wood, metal, plaster, and gypsum board as defined in Note 9 in Section 7.4 of AASHTO M 319. RCA shall also be free of all substances that fall under the category of solid waste or hazardous materials.

Aggregate for subbase shall not contain particles of rock which will not pass the 6 inch square mesh sieve.

703.08 Recycled Asphalt Pavement Recycled asphalt pavement shall consist of salvaged asphalt materials from milled pavements or production waste that has been processed before use to meet the requirements of the job mix formula. It shall be free of winter sand, granular fill, construction debris, or other materials not generally considered asphalt pavement.

703.081 RAP for Asphalt Pavement Recycled Asphalt Pavement (RAP) may be introduced into hot-mix asphalt pavement at percentages approved by the Department according to the MaineDOT Policies and Procedures for HMA Sampling and Testing.

If approved by the Department, the Contractor shall provide documentation stating the source, test results for average residual asphalt content, and stockpile gradations showing RAP materials have been sized to meet the maximum aggregate size requirements of each mix designation. The Department will obtain samples for verification and approval prior to its use.

The maximum allowable percent of RAP shall be determined by the asphalt content, the percent passing the 0.075 mm sieve, the ratio between the percent passing the 0.075 mm sieve and the asphalt content, and Coarse Micro-Deval loss values as tested by the Department.

The maximum percentage of RAP allowable shall be the lowest percentage as determined according to Table 4 below:

Classification	Maximum RAP Percentage Allowed	Asphalt content standard deviation	Percent passing 0.075 mm sieve standard deviation	Percent passing 0.075 mm sieve / asphalt content ratio	Residual aggregate M-D loss value
Class III	10%	≤ 1.0	N/A	≤ 4.0	≤ 18
Class II	20%	≤ 0.5	≤ 1.0	≤ 2.8	
Class I	30%	≤ 0.3	≤ 0.5	≤ 1.8	

Table 4: Maximum Percent RAP According to Test Results

The Department will monitor RAP asphalt content and gradation during production by testing samples from the stockpile at approximately 15,000 T intervals (in terms of mix production). The

allowable variance limits (from the numerical average values used for mix designs) for this testing are determined based upon the maximum allowable RAP percentage and are shown below in Table 5.

Table 5: RAP Verification Limits

Classification	Asphalt content (compared to aim)	Percent passing 0.075 mm sieve (compared to aim)
Class III	± 1.5	± 2.0
Class II	± 1.0	± 1.5
Class I	± 0.5	± 0.7

For specification purposes, RAP will be categorized as follows:

Class III – A maximum of 10.0 percent of Class III RAP may be used in any base, intermediate base, surface, or shim mixture. A maximum of 20.0 percent of Class III RAP may be used in hand-placed mixes for item 403.209.

Class II – A maximum of 20.0 percent Class II RAP in any base, binder, surface, or shim course.

Class I – A maximum of 20.0 percent Class I RAP may be used in any base, intermediate base, surface, or shim mixture without requiring a change to the specified asphalt binder. A maximum of 30.0 percent Class I RAP may be used in in any base or intermediate base mixture provided that a PG 58-28 or PG 58-34 asphalt binder is used. A maximum of 30.0 percent Class I RAP may be used in any surface or shim mixture provided that PG 58-34 asphalt binder is used. Mixtures exceeding 20.0 percent Class I RAP must be evaluated and approved by the Department.

The Contractor may use up to two different RAP sources in any one mix design. The total RAP percentage of the mix shall not exceed the maximum allowed for the highest classification RAP source used (i.e. if a Class I & Class III used, total RAP must not exceed 30.0%). The blended RAP material must meet all the requirements of the classification for which the RAP is entered (i.e. 10% Class III with 20% Class I, blend must meet Class I criteria). The Department may take belt cuts of the blended RAP to verify the material meets these requirements. If the Contractor elects to use more than one RAP source in a design, the Contractor shall provide an acceptable point of sampling blended RAP material from the feed belt.

In the event that RAP source or properties change, the Contractor shall notify the Department of the change and submit new documentation stating the new source or properties a minimum of 72 hours prior to the change to allow for obtaining new samples and approval.

SECTION 710 FENCE AND GUARDRAIL

710.06 Fence Posts and Braces Revise the first Paragraph so that it reads:

“Wood posts shall be of cedar, white oak, or tamarack or other AWPAs approved species, of the diameter or section and length shown on the plans.”

Remove the fourth paragraph which starts “ That portion of wood posts...”.

Revise the paragraph beginning with “Braces shall be of spruce, eastern hemlock ... so that it now reads:

“Braces shall be of spruce, eastern hemlock, Norway pine, pitch pine, or tamarack timbers or other AWPAs approved species, or spruce, cedar, tamarack or other AWPAs approved species round posts of sufficient length to make a diagonal brace between adjacent posts. All wood posts and braces shall be pressure-treated in accordance with AASHTO M 133 and AWPAs U1, UC4A Commodity Specification B: Posts. “

710.07 Guardrail Posts Revise this section so that the first sentence of section a. reads:

“a. Wood posts shall be of Norway pine, southern yellow pine, pitch pine, Douglas fir, red pine, white pine, or eastern hemlock or other AWPAs approved species.”

Revise the next paragraph so that it reads:

Wood posts and offset brackets shall be preservative treated in accordance with the requirements of AASHTO M 133 and AWPAs U1, UC4A Commodity Specification B: Posts.

710.08 Guardrail Hardware Revise this subsection by replacing “AASHTO M 298” with “ASTM B965”

SECTION 712 MISCELLANEOUS HIGHWAY MATERIAL

712.061 Structural Precast Units Amend this section by adding the following sentence to the end of the first paragraph of the Construction subsection:

“Facilities certified by NPCA or PCI shall provide to the Fabrication Engineer a copy of their annual audit to include deficiency reports and corrective actions.”

Revise this section by changing the letter “b” of ASTM C1611 of the Concrete Testing subsection so that it reads:

“b. Air content shall be 5.0% to 8.0%.”

SECTION 713 STRUCTURAL STEEL AND RELATED MATERIAL

Section 713.02 High Strength Bolts

Revise the second sentence of this subsection so that it reads **“Nuts shall meet the requirement of ASTM A563”**. Revise the third sentence of this subsection so that it reads **“Circular and beveled washers shall conform to the requirement of ASTM F436”**.

SECTION 718 TRAFFIC SIGNALS MATERIAL

718.03 Signal Mounting Amend the paragraph beginning with “All trunions, brackets and...” by adding **“For polycarbonate signal heads with more than 3 sections or requiring mounting extensions greater than 12 inches in length, reinforcing plates shall be used to reinforce the housings at the point of attachment.”** to the end of the paragraph.

718.08 Controller Cabinet Revise this subsection by replacing the paragraph beginning with “The cabinet shall be supplied with LED light panels...” on or about page 7-66 with **“The cabinet shall be supplied with white LED light panels which shall automatically illuminate via a door open switch whenever one of the four main cabinet doors are opened for the ground mount cabinet or two main doors for the side of pole cabinet. The ground mounted cabinet shall contain four LED light panels per side totaling eight panels for the cabinet; one panel each at the top and bottom portion of the front side and back side on the Control side and Power/Auxiliary side of the cabinet. Each light panel shall produce a minimum of 250 lumens for a total minimum lumen output of 2000 lumens with all eight panels illuminated. The minimum output per side would be 1000 lumens. The LED panels shall be protected by a clear shatterproof shield. The side of pole mounted cabinet shall contain four light panels; one at the top of the rack assembly and one at the bottom rack assembly on each side of the cabinet. A second door open status switch per door shall activate a controller input to log a report event that one of the doors was opened. All door open status switches shall be connected to the same controller input. For the ground mount cabinet, there shall be two switches on each of the four main doors. For the side-of-pole mount cabinet, there shall be two switches on each of the two main doors.”**

Revise this subsection by replacing the paragraph beginning with “The cabinet shall be supplied with a generator panel ...” on or about page 7-68 with:

“The cabinet shall be supplied with a generator panel. The generator panel shall

consist of a manual transfer switch and a twist-lock connector for generator hookup. The transfer switch knob and twist-lock connector shall be located inside a stainless steel enclosure with a separate lockable door accessed with a Corbin #2 key. The unit shall be mounted on the left, exterior of the control side wall of the ground mount cabinet a minimum of 36” above the surrounding grade and on the lower left side of the pole mounted cabinet. The generator transfer switch shall be a Reliance C30A1N Signa Series or approved equal. “

Revise this subsection by removing the following from the paragraph beginning with “The ground mounted cabinet shall be supplied and installed with an electric service meter socket trim and electrical service disconnect switch ...” on or about page 7-69: **“(removed: thus preventing that space from being used either by equipment supplied as part of the project, or future equipment that would be installed in the rack system. Joe indicated that he would add this language to the detail so it is covered.)”**.

Revise this subsection by replacing the following in the paragraph beginning with “The Contractor shall reconfigure the default user name...” on or around page 7-70; “MaineDOT IT” with **“MaineDOT Traffic Division”**.

In the paragraph beginning with “Tests shall be conducted by the contractor...” on or around page 7-73, amend this subsection by removing **“in the state of Maine and”** after “The facility shall be”.

Amend this Section by adding the following subsection:

718.13 Field Monitoring Unit (FMU) This item of work shall conform to this specification. This item shall consist of furnishing and installing a Field Monitoring Unit (FMU) and software, as well as all needed accessories required for a full and complete installation, including but not limited to power adapters, Ethernet cables, and interface cables, as described herein.

Where applicable, communications from MaineDOT’s cloud-based Central Management System (CMS) to the on-street traffic signal controllers shall be made through fiber optic interconnect cable connected back to existing internet connections and/or the Field Monitoring Unit (FMU). The Contractor shall furnish and install all materials necessary for a complete and operational fiber optic interconnection to all project intersections as shown on the plans. All connections to the CMS cloud-based system shall be via a secure VPN network.

The FMU shall be the only remote connection device used by isolated intersections to connect to the cloud-based system. All connections shall be encrypted VPN tunnels. The Contractor shall coordinate all configuration settings with MaineDOT IT and the Engineer.

The FMU central web based interface shall be a separate element from the CMS.

MATERIALS: The materials for this work shall conform to the following requirements:

1. The work under this item specifies the requirements for the FMU. The FMU shall operate independent of the brand/type of intersection controller deployed in the ATC traffic cabinet.
2. The FMU shall conform to the following requirements:

- 2.1 The FMU shall function correctly between -34 degrees C and +74 degrees C.
- 2.2 The FMU shall be provided with appropriately rated connectors that allows the FMU to be exchanged by unplugging connectors, without tools.
- 2.3 The FMU shall monitor and log all ATC Controller and ATC cabinet faults and or alarms.
- 2.4 The FMU shall be wired directly to the ATC cabinet.
- 2.5 The FMU shall have an internal cellular modem running at 4G LTE.
 - 2.5.1 The Cellular modem shall be designed to be replaced / upgraded to 5G service when available.
- 2.6 The FMU shall incorporate an integrated GPS and cell modem.
- 2.7 The configuration of the FMU shall be accomplished by accessing the internal web server with a browser. It shall be possible to configure the FMU without any special software.
- 2.8 The FMU shall be powered via a standard 120V input power.
- 2.9 The FMU shall allow for the routing of the controller configuration packets to and from the controller (either by Ethernet or serial communications) for any type of controller utilized by the MaineDOT. In this way it shall be possible to configure the controller and utilize the controller specific software to interrogate the controller, and the FMU shall provide the communications pipe which allows this to be accomplished.
- 2.10 The FMU shall, within the size limitations above, include a battery and battery charging/monitoring circuit, to allow the FMU to function correctly even when all power to the intersection has failed. The battery shall continue to power the FMU for a minimum of 5 hours after all power has failed to the intersection.
- 2.11 The FMU shall incorporate an integrated GPS which will allow the FMU to geo-locate itself on the FMU management software map, without configuration.
- 2.12 The FMU shall operate without requiring a static IP address. The only configuration required at the FMU is to enter the URL of where the FMU management software is hosted.
- 2.13 In the event that the cell service is interrupted or is not available, the FMU shall store any events that occur in internal memory and forward these events automatically to the FMU management software when the cell service is restored. In this way, a complete record of events at the device can be maintained even if cell service is interrupted for a period. The system will store 5000 events.
- 2.14 The FMU shall utilize HTTP and HTTPS protocols, and XML data structures, for communication with the FMU management software. In this way the data will be open

for future expansion and competition. The use of secret proprietary protocols is not permitted.

- 2.15 The FMU shall include Ethernet communications via an Ethernet Port with RJ45 connector.
- 2.16 The FMU shall include weather proof antennas.

3. Map Display FMU Management Software

- 3.1 The FMU shall include a scrollable, zoomable map display, with the intersections and other monitored devices shown as representative icons on the map. The map shall include the ability to see the intersections using Google Streetview.
- 3.2 The alarm status of the intersection shall be clearly indicated on the icon on the map, so that the user can see at a glance which intersections are in alarm.
- 3.3 The map display shall also include a list of intersections, with the number and priority of alarms indicated on the list. Intersections in high priority alarm shall be moved to the top of the list, followed by medium priority, low priority and then finally by intersections not in alarm.
- 3.4 The icons shall change to be able to clearly indicate if an intersection is offline.
- 3.5 Clicking on the icon on the map shall expose a box with the current parameters of the intersection shown.
- 3.6 The default map display position and zoom shall be configurable by user, so that the user's view will default to show the intersections that the user is responsible for managing.
- 3.7 The map view shall have the ability to show Google traffic overlays on the map.

4. Intersection Detail Display FMU Management Software

- 4.1 It shall be possible to drill down, either from the map icon or from the list, to a device level detail for the intersection, which as a minimum shall display the following parameters:
 - 4.1.1 The alarm status, with priority indicated, and a text description of the alarm (if an alarm is present for this device).
 - 4.1.2 The time since the last communication with the device
 - 4.1.3 The following parameters (real time now values, minimum for the day values, maximum for the day values, and average for the day values)
 - 4.1.3.1 The AC mains voltage (value)
 - 4.1.3.2 The battery back-up voltage (value)

- 4.1.3.3 The cabinet temperature (value)
- 4.1.3.4 The cabinet humidity (value)
- 4.1.3.5 The presence of AC power (OK or Fail)
- 4.1.3.6 The flashing status of the intersection (OK or Flashing)
- 4.1.3.7 Stop Time status (OK or Stop Time Active)
- 4.1.3.8 The cabinet door status (Open or Closed)
- 4.1.3.9 The intersection fan status (Fan On or Fan off)
- 4.1.4 It shall be possible to view graphs of each of the value parameters in graphical form, over the recent two-week period. This includes real time graphs of:
 - 4.1.4.1 The AC mains voltage
 - 4.1.4.2 The battery back-up voltage
 - 4.1.4.3 The cabinet temperature
 - 4.1.4.4 The cabinet humidity

5. Diagnostics and Log Display FMU Management Software

- 5.1 From the device level detail within the FMU management software, it shall be possible to drill down to get the raw data; the error logs; and the communications logs to allow a technician to fault-find problems.
- 5.2 It shall be possible to filter the logs by Device; by Device Type and/or by Group as well as between dates.
- 5.3 It shall be possible to print these selected logs to a local printer or a PDF file.
- 5.4 It shall be possible to export these logs to Excel on the local computer for further analysis.

6. Alarms FMU Management Software

- 6.1 The FMU management software shall have a comprehensive alarm generation capability
- 6.2 It shall be possible to configure alarms to be generated on any parameter becoming out of tolerance, including analog values, digital values and enumerated values.
- 6.3 Alarms shall be configurable to be of Low, High or Critical Priority.
- 6.4 The alarm priority shall be displayed throughout the FMU management software, on all displays, using color codes such as red-critical; yellow – high; and amber-low to indicate the priority of the alarm.

6.5 The current active alarms shall be accessible for view via an expandable window, to see which alarms are active and when the alarm occurred. The highest priority alarms shall rise to the top of the list.

7. Alerts FMU Management Software

7.1 The FMU management software shall have comprehensive alerting capability, to enable the response personnel to be notified when an abnormal situation has occurred.

7.2 It shall be possible to configure alerts to one or more personnel for each alarm. This will cause, as selected, an SMS and/or an email to be sent to the person when an alarm occurs.

7.3 The alert shall be configurable to optionally send via email and/or via SMS a message when an alarm clears.

7.4 The intention is that the FMU management software provides the alerts to the user in near real time. The SMS and email shall be issued within 30 seconds of the occurrence of event which results in an alert being issued.

8. Hosting and Connectivity and Service FMU / FMU Management Software

8.1 The contractor shall supply the FMU with the FMU manufacturers 10 year options for Connectivity and Service, as part of the purchase price. The Connectivity and Service agreement shall include at a minimum:

8.1.1 Cellular Connectivity

8.1.2 No cellular overage charges

8.1.3 Extended warranty on the hardware for the period of the Connectivity and Service Agreement

8.1.4 Over-the-air software updates

8.1.5 Over-the-air security updates

8.1.6 Future Connected Vehicles Service

SECTION 720
STRUCTURAL SUPPORTS FOR HIGHWAY SIGNS, LUMINAIRES AND
TRAFFIC SIGNALS

720.12 Wood Sign Posts Revise the first sentence so that it reads:

Wood sign posts shall be rectangular, straight and sound timber, cut from live growing native spruce, red pine, hemlock, cedar trees or other AWPAs approved species, free from loose knots or other structurally weakening defects of importance, such as shake or holes or heart rot.

Revise the third paragraph that starts with “When pressure treated...” so that it reads:

All sign posts shall be pressure-treated in accordance with AASHTO M 133 and AWPAs Standard U1, UC4A, Commodity Specification A: Sawn Products.

APPENDIX A TO DIVISION 100

SECTION 1 - BIDDING PROVISIONS

A. Federally Required Certifications By signing and delivering a Bid, the Bidder certifies as provided in all certifications set forth in this Appendix A - Federal Contract Provisions Supplement including:

- Certification Regarding No Kickbacks to Procure Contract as provided on this page 1 below.
- Certification Regarding Non-collusion as provided on page 1 below.
- Certification Regarding Non-segregated Facilities as provided by FHWA Form 1273, section III set forth on page 21 below.
- "Certification Regarding Debarment, Suspension, Ineligibility and Voluntary Exclusion" as provided by FHWA Form 1273, section XI set forth on page 32 below.
- "Certification Regarding Use of Contract Funds for Lobbying" as provided by FHWA Form 1273, section XII set forth on page 35 below.

Unless otherwise provided below, the term "Bidder", for the purposes of these certifications, includes the Bidder, its principals, and the person(s) signing the Bid. Upon execution of the Contract, the Bidder (then called the Contractor) will again make all the certifications indicated in this paragraph above.

CERTIFICATION REGARDING NO KICKBACKS TO PROCURE CONTRACT Except expressly stated by the Bidder on sheets submitted with the Bid (if any), the Bidder hereby certifies, to the best of its knowledge and belief, that it has not:

(A) employed or retained for a commission, percentage, brokerage, contingent fee, or other consideration, any firm or person (other than a bona fide employee working solely for me) to solicit or secure this contract;

(B) agreed, as an express or implied condition for obtaining this contract, to employ or retain the services of any firm or person in connection with carrying out the contract, or;

(C) paid, or agreed to pay, to any firm, organization, or person (other than a bona fide employee working solely for me) any fee, contribution, donation, or consideration of any kind for, or in connection with, procuring or carrying out the contract;

By signing and submitting a Bid, the Bidder acknowledges that this certification is to be furnished to the Maine Department of Transportation and the Federal Highway Administration, U.S. Department of Transportation in connection with this contract in anticipation of federal aid highway funds and is subject to applicable state and federal laws, both criminal and civil.

CERTIFICATION REGARDING NONCOLLUSION Under penalty of perjury as provided by federal law (28 U.S.C. §1746), the Bidder hereby certifies, to the best of its knowledge and belief, that:

the Bidder has not, either directly or indirectly, entered into any agreement, participated in any collusion, or otherwise taken any action in restraint of competitive bidding in connection with the Contract.

For a related provisions, see Section 102.7.2 (C) of the Standard Specifications - "Effects of Signing and Delivery of Bids" - "Certifications", Section 3 of this Appendix A entitled "Other Federal Requirements" including section XI - "Certification Regarding Debarment, Suspension, Ineligibility, and Voluntary Exclusion" and section XII. - "Certification Regarding Use of Contract Funds for Lobbying."

B. Bid Rigging Hotline To report bid rigging activities call: **1-800-424-9071**

The U.S. Department of Transportation (DOT) operates the above toll-free "hotline" Monday through Friday, 8:00 a.m. to 5:00 p.m., eastern time. Anyone with knowledge of possible bid rigging, bidder collusion, or other fraudulent activities should use the "hotline" to report such activities.

The "hotline" is part of the DOT's continuing effort to identify and investigate highway construction contract fraud and abuse and is operated under the direction of the DOT Inspector General. All information will be treated confidentially and caller anonymity will be respected.

SECTION 2 - FEDERAL EEO AND CIVIL RIGHTS REQUIREMENTS

Unless expressly otherwise provided in the Bid Documents, the provisions contained in this Section 2 of this "Federal Contract Provisions Supplement" are hereby incorporated into the Bid Documents and Contract.

A. Nondiscrimination & Civil Rights - Title VI The Contractor and its subcontractors shall not discriminate on the basis of race, color, national origin, or sex in the performance of this Contract. The Contractor shall carry out applicable requirements of 49 CFR Part 26 in the award and administration of DOT assisted contracts. Failure by the Contractor to carry out these requirements is a material breach of this contract, which may result in the termination of this contract or such other remedy as the Department deems appropriate. The Contractor and subcontractors shall comply with Title VI of the Civil Rights Act of 1964, as amended, and with all State of Maine and other Federal Civil Rights laws.

For related provisions, see Subsection B - "Nondiscrimination and Affirmative Action - Executive Order 11246" of this Section 2 and Section 3 - Other Federal Requirements of this "Federal Contract Provisions Supplement" including section II - "Nondiscrimination" of the "Required Contract Provisions, Federal Aid Construction Contracts", FHWA-1273.

B. Nondiscrimination and Affirmative Action - Executive Order 11246 Pursuant to Executive Order 11246, which was issued by President Johnson in 1965 and amended in 1967 and 1978, this Contract provides as follows.

The Contractor shall take specific affirmative actions to ensure equal employment opportunity. The evaluation of the Contractor's compliance with these specifications shall be based upon its efforts to achieve maximum results from its actions. The Contractor shall document these efforts fully, and shall implement affirmative action steps at least as extensive as the following:

Ensure and maintain a working environment free of harassment, intimidations, and coercion at all sites, and in all facilities at which the Contractor's employees are assigned to work. The Contractor, where possible, will assign two or more women to each construction project. The Contractor shall specifically ensure that all forepersons, superintendents, and other on-site supervisory personnel are aware of and carry out the Contractor's obligation to maintain such a working environment, with specific attention to minority or female individuals working at such sites or in such facilities.

Establish and maintain a current list of minority and female recruitment sources, provide written notification to minority and female recruitment sources and to community organizations when the Contractor or its union have employment opportunities available, and to maintain a record of the organization's responses.

Maintain a current file of the names, addresses and telephone numbers of each minority and female off-the-street applicant and minority or female referral from a union, a recruitment source or community organization and of what action was taken with respect to each such individual. If such individual was sent to the union hiring hall for referral and was not referred back to the Contractor by the union or, if referred, not employed by the Contractor, this shall be documented in the file with the reason therefore, along with whatever additional actions the Contractor may have taken.

Provide immediate written notification to the Department's Civil Rights Office when the union or unions with which the Contractor has a collective bargaining agreement has not referred to the Contractor a minority person or woman sent by the Contractor, or when the Contractor has other information that the union referral process has impeded the Design-Builder's efforts to meet its obligations.

Develop on-the-job training opportunities and/or participate in training programs for the area which expressly include minorities and women, including upgrading programs and apprenticeship and trainee programs relevant to the Contractor's employment needs, especially those programs funded or approved by the Department of Labor. The Contractor shall provide notice of these programs to the sources compiled under B above.

Disseminate the Contractor's EEO policy by providing notice of the policy to unions and training programs and requesting their cooperation in assisting the Contractor in meeting its EEO obligation; by including it in any policy manual and collective bargaining agreement; by publicizing it in the company newspaper, annual report, etc.; by specific review of the policy with all management personnel and with all minority and female employees at least once a year; and by posting the company EEO policy on bulletin boards accessible to all employees at each location where construction work is performed.

Review, at least annually, the company's EEO policy and affirmative action obligations under these specifications with all employees having any responsibility for hiring, assignment, layoff, termination, or other employment decisions including specific review of these items with on-site supervisory personnel such as Superintendents, General Forepersons, etc., prior to the initiation of construction work at any job site. A written record shall be made and maintained identifying the time and place of these meetings, persons attending, subject matter discussed, and disposition of the subject matter.

Disseminate the Contractor's EEO policy externally by including it in any advertising in the news media, specifically including minority and female news media, and providing written notification to and discussing the Contractor's EEO policy with other Contractor's and Subcontractors with whom the Contractor does or anticipates doing business.

Direct its recruitment efforts, both orally and written to minority, female and community organizations, to schools with minority and female students and to minority and female recruitment and training organizations serving the Contractor's recruitment area and employment needs. Not later than one month prior to the date for the acceptance of applications for apprenticeship or other training by any recruitment source, the Contractor shall send written notification to organizations such as the above describing the openings, screenings, procedures, and test to be used in the selection process.

Encourage present minority and female employees to recruit other minority persons and women and, where reasonable, provide after school, summer and vacation employment to minority and female youth, both on the site and in other areas of a Contractor's workforce.

Validate all tests and other selection requirements.

Conduct, at least annually, an inventory and evaluation at least of all minority and female personnel for promotional opportunities and encourage these employees to seek or to prepare for, through appropriate training, etc., such opportunities.

Ensure that seniority practices, job classifications, work assignments and other personnel practices, do not have a discriminatory effect by continually monitoring all personnel and employment related activities to ensure that the EEO policy and the Contractor's obligations under these specifications are being carried out.

Ensure that all facilities and company activities are non segregated except that separate or single-user toilet and necessary changing facilities shall be provided to assure privacy between the sexes.

Document and maintain a record of all solicitations of offers for subcontracts from minority and female construction Contractor's and suppliers, including circulation of solicitations to minority and female Contractor associations and other business associations.

Conduct a review, at least annually, of all supervisors' adherence to and performance under the Contractor's EEO policies and affirmative action obligations.

C. Goals for Employment of Women and Minorities Per Executive Order 11246, craft tradesperson goals are 6.9% women and .5% minorities employed. However, goals may be adjusted upward at the mutual agreement of the Contractor and the Department. Calculation of these percentages shall not include On-the-Job Training Program trainees, and shall not include clerical or field clerk position employees.

For a more complete presentation of requirements for such Goals, see the federally required document "Goals for Employment of Females and Minorities" set forth in the next 6 pages below.

Start of GOALS FOR EMPLOYMENT OF FEMALES AND MINORITIES
Federally Required Contract Document

§60-4.2 Solicitations

(d) The following notice shall be included in, and shall be part of, all solicitations for offers and bids on all Federal and federally assisted construction contracts or subcontracts in excess of \$10,000 to be performed in geographical areas designated by the Director pursuant to §60-4.6 of this part (see 41 CFR 60-4.2(a)):

Notice of Requirement for Affirmative Action to Ensure Equal Opportunity (Executive Order 11246)

1. The Offeror's or bidder's attention is called to the "Equal Opportunity Clause" and the "Standard Federal Equal Employment Specifications" set forth herein.
2. The goals and timetables for minority and female participation, expressed in percentage terms for the Contractor's aggregate work force in each trade on all construction work in the covered area, are as follows:

<u>Goals for female participation in each trade</u>	6.9%
---	------

Goals for minority participation for each trade

Maine

001 Bangor, ME	0.8%
----------------	------

Non-SMSA Counties (Aroostook, Hancock, Penobscot, Piscataquis, Waldo, Washington)	
---	--

002 Portland-Lewiston, ME

SMSA Counties: 4243 Lewiston-Auburn, ME	0.5%
---	------

(Androscoggin)

6403 Portland, ME	0.6%
-------------------	------

(Cumberland, Sagadahoc)

Non-SMSA Counties:
(Franklin, Kennebec, Knox, Lincoln, Oxford, Somerset, York)

These goals are applicable to all the Contractor's construction work (whether or not it is Federal or federally assisted) performed in the covered area. If the contractor performs construction work in a geographical area located outside of the covered area, it shall apply the goals established for such geographical area where the work is actually performed. With regard to this second area, the contractor also is subject to the goals for both its federally involved and non federally involved construction.

The contractor's compliance with the Executive Order and the regulations in 41 CFR Part 60-4 shall be based on its implementation of the Equal Opportunity Clause, specific affirmative action obligations required by the specifications set forth in 41 CFR 60-4.3(a), and its efforts to meet the goals. The hours of minority and female employment and training must be substantially uniform throughout the length of the contract, and in each trade, and the contractor shall make a good faith effort to employ minorities and women evenly on each of its projects. The transfer of minority or female employees or trainees from Contractor to Contractor or from project to project for the sole purpose of meeting the Contractor's goals shall be in violation of the contract, the Executive Order and the regulations in 41 CFR Part 60-4. Compliance with the goals will be measured against the total work hours performed.

3. The Contractor shall provide written notification to the Director of the Office of Federal Contract Compliance Programs within 10 working days of award of any construction subcontract in excess of \$10,000 at any tier for construction work under the contract resulting from this solicitation. The notification shall list the name, address and telephone number of the subcontractor, employer identification number of the subcontractor, estimated dollar amount of the subcontract; estimated started and completion dates of the subcontract; and the geographical area in which the subcontract is to be performed.

4. As used in this Notice, and in the Contract resulting from this solicitation, the "covered area" is (insert description of the geographical areas where the contract is to be performed giving the state, county and city, if any).

STANDARD FEDERAL EQUAL EMPLOYMENT OPPORTUNITY CONSTRUCTION
CONTRACT SPECIFICATIONS (EXECUTIVE ORDER 11246)

1. As used in these specifications:
 - a. "Covered area" means the geographical area described in the solicitation from which this contract resulted;
 - b. "Director" means Director, Office of Federal Contract Compliance Programs, United States Department of Labor, or any person to whom the Director delegates authority;
 - c. "Employer identification number" means the Federal Social Security number used on the Employer's Quarterly Federal Tax Return, U.S. Treasury Department form 941;
 - d. "Minority" includes:

- (i) Black (all persons having origins in any of the Black African racial groups not of Hispanic origin);
 - (ii) Hispanic (all persons of Mexican, Puerto Rican, Cuban, Central or South American or other Spanish Culture or origin, regardless of race);
 - (iii) Asian and Pacific Islander (all persons having origins in any of the original peoples of the Far East, Southeast Asia, the Indian Subcontinent, or the Pacific Islands); and
 - (iv) American Indian or Alaskan Native (all persons having origins in any of the original peoples of the North America and maintaining identifiable tribal affiliations through membership and participation or community identification).
2. Whenever the Contractor, or any subcontractor at any tier, subcontracts a portion of the work involving any construction trade, it shall physically include in each subcontract in excess of \$10,000 the provisions of these specifications and the Notice which contains the applicable goals for minority and female participation and which is set forth in the solicitations from which this contract resulted.
3. If the contractor, is participating (pursuant to 41 CFR 60-4.5) in a Hometown Plan approved by the U.S. Department of Labor in the covered area either individually or through an association, its affirmative action obligations on all work in the Plan area (including goals and timetables) shall be in accordance with that Plan for those trades which have unions participating in the Plan. Contractors must be able to demonstrate their participation in and compliance with the provisions of any such Hometown Plan. Each Contractor or Subcontractor participating in an approved Plan is individually required to comply with its obligations under the EEO clause, and to make a good faith effort to achieve each goal under the Plan in each trade in which it has employees. The overall good faith performance by other Contractors for Subcontractors toward a goal in an approved Plan does not excuse any covered Contractor's or Subcontractor's failure to take good faith efforts to achieve the Plan goals and timetables.
4. The Contractor shall implement the specific affirmative action standards provided in paragraphs 7 a. through p. of these specifications. The goals set forth in the solicitation from which this contract resulted are expressed as percentages of the total hours of employment and training of minority and female utilization the Contractor should reasonably be able to achieve in each construction trade in which it has employees in contractors performing construction work in geographical areas where they do not have a Federal or federally assisted construction contract shall apply the minority and female goals established for the geographical areas where the work is being performed. Goals are published periodically in the Federal Register in notice form and such notices may be obtained from any Office of Federal Contract Compliance Programs office or from Federal procurement contracting officers. The Contractor is expected to make substantially uniform progress in meeting its goals in each craft during the period specific.
5. Neither the provisions of any collective bargaining agreement, nor the failure by a union with whom the Contractor has a collective bargaining agreement, to refer either minorities or women shall excuse the Contractor's obligations under these specifications, Executive Order 11246, or the regulations promulgated pursuant, thereto.

6. In order for the non working training hours of apprentices and trainees to be counted in meeting the goals, such apprentices and trainees must be employed by the Contractor during the training period, and the Contractor must have made a commitment to employ the apprentices and trainees at the completion of their training, subject to the availability of employment opportunities. Trainees must be trained pursuant to training programs approved by the U.S. Department of Labor.
7. The Contractor shall take specific affirmative actions to ensure equal employment opportunity. The evaluation of the Contractor's compliance with these specifications shall be based upon its effort to achieve maximum results from its actions. The Contractor shall document these efforts fully, and shall implement affirmative action steps at least as expensive as the following:
 - a. Ensure and maintain a working environment free of harassment, intimidation, coercion at all sites, and in all facilities at which the Contractor's employees are assigned to work. The Contractor, when possible, will assign two or more women to each construction project. The Contractor shall specifically ensure that all foremen, superintendents, and other on-site supervisory personnel are aware of and carry out the Contractor's obligation to maintain such a working environment, with specific attention to minority or female individuals working at such sites or in such facilities.
 - b. Establish and maintain a current list of minority and female recruitment sources provide written notification to minority and female recruitment sources and to community organizations when the Contractor or its unions have employment opportunities available, and maintain a record of the organization's responses.
 - c. Maintain a current file of the names, addresses and telephone numbers of each minority and female off-the-street applicant and minority or female referral from a union, a recruitment sources or community organization and of what action was taken with respect to each such individual. If such individual was sent to the union hiring hall for referral and was not referred back to the Contractor by the union or, if referred, not employed by the Contractor, this shall be documented in the file with the reason therefore, along with whatever additional actions the Contractor may have taken.
 - d. Provide immediate written notification to the Director when the union or unions with which the Contractor has a collective bargaining agreement has not referred to the Contractor a minority person or woman sent by the Contractor, or when the Contractor has other information that the union referral process has impeded the Contractor's efforts to meet its obligations.
 - e. Develop on-the-job training opportunities and/or participate in training programs for the area which expressly include minorities and women, including upgrading programs and apprenticeship and trainee programs relevant to the Contractor's employment needs, especially those programs funded or approved by the Department of Labor. The Contractor shall provide notice of these programs to the sources complied under 7b above.

- f. Disseminate the Contractor's EEO policy by providing notice of the policy to unions and training programs and requesting their cooperation in assisting the Contractor in meeting its EEO obligations; by including in any policy manual and collective bargaining agreement; by publicizing it in the company newspaper, annual report, etc.; by specific review of the policy with all management personnel and with all minority and female employees at least once a year; and by posting the company EEO policy on bulletin boards accessible to all employees at each location where construction work is performed.
- g. Review, at least annually, the company's EEO policy and affirmative action obligations under these specifications with all employees having any responsibility for hiring, assignment, layoff, termination or other employment decisions including specific review of these items with on-site supervisory personnel such as Superintendents, General Foremen, etc., prior to the initiation of construction work at any job site. A written record shall be made and maintained identifying the time and place of these meetings, persons attending, subject matter discussed, and disposition of the subject matter.
- h. Disseminate the Contractor's EEO policy externally by including it in any advertising in the news media, specifically including minority and female news media, and providing written notification to and discussing the Contractor's EEO policy with other Contractors and Subcontractors with whom the Contractor does or anticipates doing business.
- i. Direct its recruitment, efforts, both oral and written, to minority, female and community organizations, to schools with minority and female students and to minority and female recruitment and training organizations serving the Contractor's recruitment area and employment needs. Not later than one month other training by any recruitment source, the Contractor shall send written notification to organizations such as the above, describing prior to the date for the acceptance of applications for apprenticeship or the openings, screening procedures, and tests to be used in the selection process.
- j. Encourage present minority and female employees to recruit other minority persons and women and, where reasonable, provide after school, summer and vacation employment to minority and female youth both on site and in other areas of a Contractor's work force.
- k. Validate all tests and other selection requirements where there is an obligation to do so under 41 CFR Part 60-3.
- l. Conduct, at least annually, an inventory and evaluation at least of all minority and female personnel for promotional opportunities and encourage these employees to seek or to prepare for, through appropriate training, etc., such opportunities.
- m. Ensure that seniority practices, job classifications, work assignments and other personnel practices, do not have a discriminatory effect by continually monitoring all personnel and employment related activities to ensure that the EEO policy and the Contractor's obligations under these specifications are being carried out.

- n. Ensure that all facilities and company activities are non segregated except that separate or single-user toilet and necessary changing facilities shall be provided to assure privacy between the sexes.
 - o. Document and maintain a record of all solicitations of offers for subcontracts from minority and female construction contractors and suppliers, including circulation of solicitation to minority and female contractor associations and other business associations.
 - p. Conduct a review, at least annually, of all supervisor's adherence to and performance under the Contractor's EEO policies and affirmative action obligations.
8. Contractors are encouraged to participate in voluntary associations which assist in fulfilling one or more of their affirmative action obligations (7 a through p.). The efforts of a contractor association, joint contractor-union, contractor-community, or other similar group of which the contractor is a member and participant, may be asserted as fulfilling any one or more of its obligations under 7 a through p. of these specifications provided that the contractor actively participates in the group, makes every effort to assure that the group has a positive impact on the employment of minorities and women in the industry, ensures that the concrete benefits of the program and reflected in the Contractor's minority and female work force participation, makes a good faith effort to meet its individual goals and timetables, and can provide access to documentation which demonstrates the effectiveness of actions take on behalf of the Contractor. The obligation to comply, however, is the Contractor's and failure of such a group to fulfill an obligation shall not be a defense for the Contractor's noncompliance.
9. A single goal for minorities and a separate single goal for women have been established. The Contractor, however, is required to provide equal employment opportunity and to take affirmative action for all minority groups, both male and female, and all women, both minority and non-minority. Consequently, the Contractor may be in violation of the Executive Order if a particular group is employed in a substantially disparate manner (for example, specific minority group of women is underutilized.)
10. The Contractor shall not use the goals and timetables or affirmative action even though the Contractor has achieved its goals for women generally, the Contractor may be in violation of the Executive Order if standards to discriminate against any person because of race, color, religion, sex, or national origin.
11. The Contractor shall not enter into any Subcontract with any person or firm debarred from Government contracts pursuant to Executive Order 11246.
12. The Contractor shall carry out such sanctions and penalties for violation of these specifications and of the Equal Opportunity Clause, including suspension, termination and cancellation of existing subcontracts as may be imposed or ordered pursuant to Executive Order 11246, as amended, and its implementation regulations by the Office of Federal Contract Compliance Programs. Any Contractor who fails to carry out such sanctions and penalties shall be in violation of these specifications and Executive Order 11246, as amended.

13. The Contractor, in fulfilling its obligations under these specifications, shall implement specific affirmative action steps, at least as extensive as those standards prescribed in paragraph 7 of these specifications, so as to achieve maximum results from its efforts to ensure equal employment opportunity. If the Contractor fails to comply with the requirements of the Executive Order, the implementing regulations, or these specifications, the Director shall proceed in accordance with 41 CFR 60-4.6.
14. The Contractor shall designate a responsible official to monitor all employment related activity to ensure that the company EEO policy is being carried out, to submit reports relating to the provisions hereof as may be required by the Government and to keep records. Records shall at least include for each employee the name, address, telephone numbers, construction trade, union affiliation if any, employee identification number when assigned, social security number, race, sex, status (e.g. mechanic, apprentice, trainee, helper, or laborer), dates of changes in status, hours worked per week in the indicated trade, rate of pay, and location at which the work was performed. Records be maintained in an easily understandable and retrievable form; however, to the degree that existing records satisfy this requirement, contractors shall not be required to maintain separate records.
15. Nothing herein provided shall be construed as a limitation upon the application of other laws which establish different standards of compliance or upon the application of requirements for the hiring of local or other area residents (e.g., those under the Public Works Employment Act of 1977 and the Community Development Block Grant Program).

End of GOALS FOR EMPLOYMENT OF FEMALES AND MINORITIES
Federally Required Contract Document

D. Section '**D Disadvantaged Business Enterprise (DBE) Requirements**' is removed in its entirety. The DBE material is in:

Section 105.10 EQUAL OPPORTUNITY AND CIVIL RIGHTS.

SECTION 3 - OTHER FEDERAL REQUIREMENTS

Unless expressly otherwise provided in the Bid Documents, the provisions contained in this Section 3 of this "Federal Contract Provisions Supplement" are hereby incorporated into the Bid Documents and Contract.

A. Buy America

If the cost of products purchased for permanent use in this project which are manufactured of steel, iron or the application of any coating to products of these materials exceeds 0.1 percent of the contract amount, or \$2,500.00, whichever is greater, the products shall have been manufactured and the coating applied in the United States. The coating materials are not subject to this clause, only the application of the coating. In computing that amount, only the cost of the product and coating application cost will be included.

Ore, for the manufacture of steel or iron, may be from outside the United States; however, all other manufacturing processes of steel or iron must be in the United States to qualify as having been manufactured in the United States.

United States includes the 50 United States and any place subject to the jurisdiction thereof.

Products of steel include, but are not limited to, such products as structural steel, piles, guardrail, steel culverts, reinforcing steel, structural plate and steel supports for signs, luminaries and signals.

Products of iron include, but are not limited to, such products as cast iron grates.

Application of coatings include, but are not limited to, such applications as epoxy, galvanized and paint.

To assure compliance with this section, the Contractor shall submit a certification letter on its letterhead to the Department stating the following:

“This is to certify that products made of steel, iron or the application of any coating to products of these materials whose costs are in excess of \$2,500.00 or 0.1 percent of the original contract amount, whichever is greater, were manufactured and the coating, if one was required, was applied in the United States.”

B. Materials

a. Convict Produced Materials References: 23 U.S.C. 114(b)(2), 23 CFR 635.417

Applicability: FHWA's prohibition against the use of convict material only applies to Federal-aid highways. Materials produced after July 1, 1991, by convict labor may only be incorporated in a Federal-aid highway construction project if: 1) such materials have been produced by convicts who are on parole, supervised release, or probation from a prison; or 2) such material has been produced in a qualified prison facility, e.g., prison industry, with the amount produced during any 12-month period, for use in Federal-aid projects, not exceeding the amount produced, for such use, during the 12-month period ending July 1, 1987.

Materials obtained from prison facilities (e.g., prison industries) are subject to the same requirements for Federal-aid participation that are imposed upon materials acquired from other sources. Materials manufactured or produced by convict labor will be given no preferential treatment.

The preferred method of obtaining materials for a project is through normal contracting procedures which require the contractor to furnish all materials to be incorporated in the work. The contractor selects the source, public or private, from which the materials are to be obtained (23 CFR 635.407). Prison industries are prohibited from bidding on projects directly (23 CFR 635.112e), but may act as material supplier to construction contractors.

Prison materials may also be approved as State-furnished material. However, since public agencies may not bid in competition with private firms, direct acquisition of materials from a

prison industry for use as State-furnished material is subject to a public interest finding with the Division Administrator's concurrence (23 CFR 635.407d). Selection of materials produced by convict labor as State-furnished materials for mandatory use should be cleared prior to the submittal of the Plans Specifications & Estimates (PS&E).

b. Patented/Proprietary Products References: 23 U.S.C. 112, 23 CFR 635.411

FHWA will not participate, directly or indirectly, in payment for any premium or royalty on any patented or proprietary material, specification, or process specifically set forth in the plans and specifications for a project, unless:

- the item is purchased or obtained through competitive bidding with equally suitable unpatented items,
- the STA certifies either that the proprietary or patented item is essential for synchronization with the existing highway facilities or that no equally suitable alternative exists, or
- the item is used for research or for a special type of construction on relatively short sections of road for experimental purposes. States should follow FHWA's procedures for "Construction Projects Incorporating Experimental Features" ([expermnt.htm](#)) for the submittal of work plans and evaluations.

The primary purpose of the policy is to have competition in selection of materials and allow for development of new materials and products. The policy further permits materials and products that are judged equal may be bid under generic specifications. If only patented or proprietary products are acceptable, they shall be bid as alternatives with all, or at least a reasonable number of, acceptable materials or products listed; and the Division Administrator may approve a single source if it can be found that its utilization is in the public interest.

Trade names are generally the key to identifying patented or proprietary materials. Trade name examples include 3M, Corten, etc. Generally, products identified by their brand or trade name are not to be specified without an "or equal" phrase, and, if trade names are used, all, or at least a reasonable number of acceptable "equal" materials or products should be listed. The licensing of several suppliers to produce a product does not change the fact that it is a single product and should not be specified to the exclusion of other equally suitable products.

c. State Preference References: 23 U.S.C. 112, 23 CFR 635.409

Materials produced within Maine shall not be favored to the exclusion of comparable materials produced outside of Maine. State preference clauses give particular advantage to the designated source and thus restrict competition. Therefore, State preference provisions shall not be used on any Federal-aid construction projects.

This policy also applies to State preference actions against materials of foreign origin, except as otherwise permitted by Federal law. Thus, States cannot give preference to in-State material sources over foreign material sources. Under the Buy America provisions, the States are

permitted to expand the Buy America restrictions provided that the STA is legally authorized under State law to impose more stringent requirements.

d. State Owned/Furnished/Designated Materials References: 23 U.S.C. 112, 23 CFR 635.407

Current FHWA policy requires that the contractor must furnish all materials to be incorporated in the work, and the contractor shall be permitted to select the sources from which the materials are to be obtained. Exceptions to this requirement may be made when there is a definite finding, by MaineDOT and concurred in by Federal Highway Administration's (FHWA) Division Administrator, that it is in the public interest to require the contractor to use materials furnished by the MaineDOT or from sources designated by MaineDOT. The exception policy can best be understood by separating State-furnished materials into the categories of manufactured materials and local natural materials.

Manufactured Materials When the use of State-furnished manufactured materials is approved based on a public interest finding, such use must be made mandatory. The optional use of State-furnished manufactured materials is in violation of our policy prohibiting public agencies from competing with private firms. Manufactured materials to be furnished by MaineDOT must be acquired through competitive bidding, unless there is a public interest finding for another method, and concurred in by FHWA's Division Administrator.

Local Natural Materials When MaineDOT owns or controls a local natural materials source such as a borrow pit or a stockpile of salvaged pavement material, etc., the materials may be designated for either optional or mandatory use; however, mandatory use will require a public interest finding (PIF) and FHWA's Division Administrator's concurrence.

In order to permit prospective bidders to properly prepare their bids, the location, cost, and any conditions to be met for obtaining materials that are made available to the contractor shall be stated in the bidding documents.

Mandatory Disposal Sites Normally, the disposal site for surplus excavated materials is to be of the contractor's choosing; although, an optional site(s) may be shown in the contract provisions. A mandatory site shall be specified when there is a finding by MaineDOT, with the concurrence of the Division Administrator, that such placement is the most economical or that the environment would be substantially enhanced without excessive cost. Discussion of the mandatory use of a disposal site in the environmental document may serve as the basis for the public interest finding.

Summarizing FHWA policy for the mandatory use of borrow or disposal sites:

- mandatory use of either requires a public interest finding and FHWA's Division Administrator's concurrence,
- mandatory use of either may be based on environmental consideration where the environment will be substantially enhanced without excessive additional cost, and
- where the use is based on environmental considerations, the discussion in the environmental document may be used as the basis for the public interest finding.

Factors to justify a public interest finding should include such items as cost effectiveness, system integrity, and local shortages of material.

C. Standard FHWA Contract Provisions - FHWA 1273

Unless expressly otherwise provided in the Bid Documents, the following “Required Contract Provisions, Federal Aid Construction Contracts”, FHWA-1273, are hereby incorporated into the Bid Documents and Contract.

Cargo Preference Act : Contractor and Subcontractor Clauses. “Use of United States-flag vessels: The contractor agrees—“(1) To utilize privately owned United States-flag commercial vessels to ship at least 50 percent of the gross tonnage (computed separately for dry bulk carriers, dry cargo liners, and tankers) involved, whenever shipping any equipment, material, or commodities pursuant to this contract, to the extent such vessels are available at fair and reasonable rates for United States-flag commercial vessels.”(2) To furnish within 20 days following the date of loading for shipments originating within the United States or within 30 working days following the date of loading for shipments originating outside the United States, a legible copy of a rated, ‘on-board’ commercial ocean bill-of-lading in English for each shipment of cargo described in paragraph (1) of this section to both the Contracting Officer (through the prime contractor in the case of subcontractor bills-of-lading) and to the Division of National Cargo, Office of Market Development, Maritime Administration, Washington, DC 20590.”(3) To insert the substance of the provisions of this clause in all subcontracts issued pursuant to this contract.”(Reorganization Plans No. 21 of 1950 (64 Stat. 1273) and No. 7 of 1961 (75 Stat. 840) as amended by Pub. L. 91-469 (84 Stat. 1036) and Department of Commerce Organization Order 10-8 (38 FR 19707, July 23, 1973)) [42 FR 57126, Nov. 1, 1977]

The Cargo Preference Act requirements apply to materials or equipment that are acquired for a specific Federal-aid highway project. In general, the requirements are not applicable to goods or materials that come into inventories independent of an FHWA funded-contract. For example, the requirements would not apply to shipments of Portland cement, asphalt cement, or aggregates, as industry suppliers and contractors use these materials to replenish existing inventories. In general, most of the materials used for highway construction originate from existing inventories and are not acquired solely for a specific Federal-aid project. However, if materials or equipment are acquired solely for a Federal-aid project, then the Cargo Preference Act requirements apply.”

Start of FHWA 1273 REQUIRED CONTRACT PROVISIONS
FEDERAL-AID CONSTRUCTION CONTRACTS (As revised through May 1, 2012)

FHWA-1273 -- Revised May 1, 2012

**REQUIRED CONTRACT PROVISIONS
FEDERAL-AID CONSTRUCTION CONTRACTS**

- I. General
- II. Nondiscrimination
- III. Nonsegregated Facilities
- IV. Davis-Bacon and Related Act Provisions
- V. Contract Work Hours and Safety Standards Act Provisions
- VI. Subletting or Assigning the Contract
- VII. Safety: Accident Prevention
- VIII. False Statements Concerning Highway Projects
- IX. Implementation of Clean Air Act and Federal Water Pollution Control Act
- X. Compliance with Governmentwide Suspension and Debarment Requirements
- XI. Certification Regarding Use of Contract Funds for Lobbying

ATTACHMENTS

A. Employment and Materials Preference for Appalachian Development Highway System or Appalachian Local Access Road Contracts (included in Appalachian contracts only)

I. GENERAL

1. Form FHWA-1273 must be physically incorporated in each construction contract funded under Title 23 (excluding emergency contracts solely intended for debris removal). The contractor (or subcontractor) must insert this form in each subcontract and further require its inclusion in all lower tier subcontracts (excluding purchase orders, rental agreements and other agreements for supplies or services).

The applicable requirements of Form FHWA-1273 are incorporated by reference for work done under any purchase order, rental agreement or agreement for other services. The prime contractor shall be responsible for compliance by any subcontractor, lower-tier subcontractor or service provider.

Form FHWA-1273 must be included in all Federal-aid design-build contracts, in all subcontracts and in lower tier subcontracts (excluding subcontracts for design services, purchase orders, rental agreements and other agreements for supplies or services). The design-builder shall be responsible for compliance by any subcontractor, lower-tier subcontractor or service provider.

Contracting agencies may reference Form FHWA-1273 in bid proposal or request for proposal documents, however, the Form FHWA-1273 must be physically incorporated (not referenced) in all contracts, subcontracts and lower-tier subcontracts (excluding purchase orders, rental agreements and other agreements for supplies or services related to a construction contract).

2. Subject to the applicability criteria noted in the following sections, these contract provisions shall apply to all work performed on the contract by the contractor's own organization and with the assistance of workers under the contractor's immediate superintendence and to all work performed on the contract by piecework, station work, or by subcontract.

3. A breach of any of the stipulations contained in these Required Contract Provisions may be sufficient grounds for withholding of progress payments, withholding of final payment,

termination of the contract, suspension / debarment or any other action determined to be appropriate by the contracting agency and FHWA.

4. Selection of Labor: During the performance of this contract, the contractor shall not use convict labor for any purpose within the limits of a construction project on a Federal-aid highway unless it is labor performed by convicts who are on parole, supervised release, or probation. The term Federal-aid highway does not include roadways functionally classified as local roads or rural minor collectors.

II. NONDISCRIMINATION

The provisions of this section related to 23 CFR Part 230 are applicable to all Federal-aid construction contracts and to all related construction subcontracts of \$10,000 or more. The provisions of 23 CFR Part 230 are not applicable to material supply, engineering, or architectural service contracts.

In addition, the contractor and all subcontractors must comply with the following policies: Executive Order 11246, 41 CFR 60, 29 CFR 1625-1627, Title 23 USC Section 140, the Rehabilitation Act of 1973, as amended (29 USC 794), Title VI of the Civil Rights Act of 1964, as amended, and related regulations including 49 CFR Parts 21, 26 and 27; and 23 CFR Parts 200, 230, and 633.

The contractor and all subcontractors must comply with: the requirements of the Equal Opportunity Clause in 41 CFR 60-1.4(b) and, for all construction contracts exceeding \$10,000, the Standard Federal Equal Employment Opportunity Construction Contract Specifications in 41 CFR 60-4.3.

Note: The U.S. Department of Labor has exclusive authority to determine compliance with Executive Order 11246 and the policies of the Secretary of Labor including 41 CFR 60, and 29 CFR 1625-1627. The contracting agency and the FHWA have the authority and the responsibility to ensure compliance with Title 23 USC Section 140, the Rehabilitation Act of 1973, as amended (29 USC 794), and Title VI of the Civil Rights Act of 1964, as amended, and related regulations including 49 CFR Parts 21, 26 and 27; and 23 CFR Parts 200, 230, and 633.

The following provision is adopted from 23 CFR 230, Appendix A, with appropriate revisions to conform to the U.S. Department of Labor (US DOL) and FHWA requirements.

1. Equal Employment Opportunity: Equal employment opportunity (EEO) requirements not to discriminate and to take affirmative action to assure equal opportunity as set forth under laws, executive orders, rules, regulations (28 CFR 35, 29 CFR 1630, 29 CFR 1625-1627, 41 CFR 60 and 49 CFR 27) and orders of the Secretary of Labor as modified by the provisions prescribed herein, and imposed pursuant to 23 U.S.C. 140 shall constitute the EEO and specific affirmative action standards for the contractor's project activities under this contract. The provisions of the Americans with Disabilities Act of 1990 (42 U.S.C. 12101 et seq.) set forth under 28 CFR 35 and 29 CFR 1630 are incorporated by reference in this contract. In the execution of this contract, the contractor agrees to comply with the following minimum specific requirement activities of EEO:

a. The contractor will work with the contracting agency and the Federal Government to ensure that it has made every good faith effort to provide equal opportunity with respect to all of its terms and conditions of employment and in their review of activities under the contract.

b. The contractor will accept as its operating policy the following statement:

"It is the policy of this Company to assure that applicants are employed, and that employees are treated during employment, without regard to their race, religion, sex, color, national origin, age or disability. Such action shall include: employment, upgrading, demotion, or transfer; recruitment or recruitment advertising; layoff or termination; rates of pay or other forms of compensation; and selection for training, including apprenticeship, pre-apprenticeship, and/or on-the-job training."

2. EEO Officer: The contractor will designate and make known to the contracting officers an EEO Officer who will have the responsibility for and must be capable of effectively administering and promoting an active EEO program and who must be assigned adequate authority and responsibility to do so.

3. Dissemination of Policy: All members of the contractor's staff who are authorized to hire, supervise, promote, and discharge employees, or who recommend such action, or who are substantially involved in such action, will be made fully cognizant of, and will implement, the contractor's EEO policy and contractual responsibilities to provide EEO in each grade and classification of employment. To ensure that the above agreement will be met, the following actions will be taken as a minimum:

a. Periodic meetings of supervisory and personnel office employees will be conducted before the start of work and then not less often than once every six months, at which time the contractor's EEO policy and its implementation will be reviewed and explained. The meetings will be conducted by the EEO Officer.

b. All new supervisory or personnel office employees will be given a thorough indoctrination by the EEO Officer, covering all major aspects of the contractor's EEO obligations within thirty days following their reporting for duty with the contractor.

c. All personnel who are engaged in direct recruitment for the project will be instructed by the EEO Officer in the contractor's procedures for locating and hiring minorities and women.

d. Notices and posters setting forth the contractor's EEO policy will be placed in areas readily accessible to employees, applicants for employment and potential employees.

e. The contractor's EEO policy and the procedures to implement such policy will be brought to the attention of employees by means of meetings, employee handbooks, or other appropriate means.

4. Recruitment: When advertising for employees, the contractor will include in all advertisements for employees the notation: "An Equal Opportunity Employer." All such advertisements will be placed in publications having a large circulation among minorities and women in the area from which the project work force would normally be derived.

- a. The contractor will, unless precluded by a valid bargaining agreement, conduct systematic and direct recruitment through public and private employee referral sources likely to yield qualified minorities and women. To meet this requirement, the contractor will identify sources of potential minority group employees, and establish with such identified sources procedures whereby minority and women applicants may be referred to the contractor for employment consideration.
- b. In the event the contractor has a valid bargaining agreement providing for exclusive hiring hall referrals, the contractor is expected to observe the provisions of that agreement to the extent that the system meets the contractor's compliance with EEO contract provisions. Where implementation of such an agreement has the effect of discriminating against minorities or women, or obligates the contractor to do the same, such implementation violates Federal nondiscrimination provisions.
- c. The contractor will encourage its present employees to refer minorities and women as applicants for employment. Information and procedures with regard to referring such applicants will be discussed with employees.

5. Personnel Actions: Wages, working conditions, and employee benefits shall be established and administered, and personnel actions of every type, including hiring, upgrading, promotion, transfer, demotion, layoff, and termination, shall be taken without regard to race, color, religion, sex, national origin, age or disability.

The following procedures shall be followed:

- a. The contractor will conduct periodic inspections of project sites to insure that working conditions and employee facilities do not indicate discriminatory treatment of project site personnel.
- b. The contractor will periodically evaluate the spread of wages paid within each classification to determine any evidence of discriminatory wage practices.
- c. The contractor will periodically review selected personnel actions in depth to determine whether there is evidence of discrimination. Where evidence is found, the contractor will promptly take corrective action. If the review indicates that the discrimination may extend beyond the actions reviewed, such corrective action shall include all affected persons.
- d. The contractor will promptly investigate all complaints of alleged discrimination made to the contractor in connection with its obligations under this contract, will attempt to resolve such complaints, and will take appropriate corrective action within a reasonable time. If the investigation indicates that the discrimination may affect persons other than the complainant, such corrective action shall include such other persons. Upon completion of each investigation, the contractor will inform every complainant of all of their avenues of appeal.

6. Training and Promotion:

a. The contractor will assist in locating, qualifying, and increasing the skills of minorities and women who are applicants for employment or current employees. Such efforts should be aimed at developing full journey level status employees in the type of trade or job classification involved.

b. Consistent with the contractor's work force requirements and as permissible under Federal and State regulations, the contractor shall make full use of training programs, i.e., apprenticeship, and on-the-job training programs for the geographical area of contract performance. In the event a special provision for training is provided under this contract, this subparagraph will be superseded as indicated in the special provision. The contracting agency may reserve training positions for persons who receive welfare assistance in accordance with 23 U.S.C. 140(a).

c. The contractor will advise employees and applicants for employment of available training programs and entrance requirements for each.

d. The contractor will periodically review the training and promotion potential of employees who are minorities and women and will encourage eligible employees to apply for such training and promotion.

7. Unions: If the contractor relies in whole or in part upon unions as a source of employees, the contractor will use good faith efforts to obtain the cooperation of such unions to increase opportunities for minorities and women.

Actions by the contractor, either directly or through a contractor's association acting as agent, will include the procedures set forth below:

a. The contractor will use good faith efforts to develop, in cooperation with the unions, joint training programs aimed toward qualifying more minorities and women for membership in the unions and increasing the skills of minorities and women so that they may qualify for higher paying employment.

b. The contractor will use good faith efforts to incorporate an EEO clause into each union agreement to the end that such union will be contractually bound to refer applicants without regard to their race, color, religion, sex, national origin, age or disability.

c. The contractor is to obtain information as to the referral practices and policies of the labor union except that to the extent such information is within the exclusive possession of the labor union and such labor union refuses to furnish such information to the contractor, the contractor shall so certify to the contracting agency and shall set forth what efforts have been made to obtain such information.

d. In the event the union is unable to provide the contractor with a reasonable flow of referrals within the time limit set forth in the collective bargaining agreement, the contractor will, through independent recruitment efforts, fill the employment vacancies without regard to race, color, religion, sex, national origin, age or disability; making full efforts to obtain qualified and/or qualifiable minorities and women. The failure of a union to provide sufficient referrals (even

though it is obligated to provide exclusive referrals under the terms of a collective bargaining agreement) does not relieve the contractor from the requirements of this paragraph. In the event the union referral practice prevents the contractor from meeting the obligations pursuant to Executive Order 11246, as amended, and these special provisions, such contractor shall immediately notify the contracting agency.

8. Reasonable Accommodation for Applicants / Employees with Disabilities: The contractor must be familiar with the requirements for and comply with the Americans with Disabilities Act and all rules and regulations established there under. Employers must provide reasonable accommodation in all employment activities unless to do so would cause an undue hardship.

9. Selection of Subcontractors, Procurement of Materials and Leasing of Equipment: The contractor shall not discriminate on the grounds of race, color, religion, sex, national origin, age or disability in the selection and retention of subcontractors, including procurement of materials and leases of equipment. The contractor shall take all necessary and reasonable steps to ensure nondiscrimination in the administration of this contract.

a. The contractor shall notify all potential subcontractors and suppliers and lessors of their EEO obligations under this contract.

b. The contractor will use good faith efforts to ensure subcontractor compliance with their EEO obligations.

10. Assurance Required by 49 CFR 26.13(b):

a. The requirements of 49 CFR Part 26 and the State DOT's U.S. DOT-approved DBE program are incorporated by reference.

b. The contractor or subcontractor shall not discriminate on the basis of race, color, national origin, or sex in the performance of this contract. The contractor shall carry out applicable requirements of 49 CFR Part 26 in the award and administration of DOT-assisted contracts. Failure by the contractor to carry out these requirements is a material breach of this contract, which may result in the termination of this contract or such other remedy as the contracting agency deems appropriate.

11. Records and Reports: The contractor shall keep such records as necessary to document compliance with the EEO requirements. Such records shall be retained for a period of three years following the date of the final payment to the contractor for all contract work and shall be available at reasonable times and places for inspection by authorized representatives of the contracting agency and the FHWA.

a. The records kept by the contractor shall document the following:

(1) The number and work hours of minority and non-minority group members and women employed in each work classification on the project;

(2) The progress and efforts being made in cooperation with unions, when applicable, to increase employment opportunities for minorities and women; and

(3) The progress and efforts being made in locating, hiring, training, qualifying, and upgrading minorities and women;

b. The contractors and subcontractors will submit an annual report to the contracting agency each July for the duration of the project, indicating the number of minority, women, and non-minority group employees currently engaged in each work classification required by the contract work. This information is to be reported on [Form FHWA-1391](#). The staffing data should represent the project work force on board in all or any part of the last payroll period preceding the end of July. If on-the-job training is being required by special provision, the contractor will be required to collect and report training data. The employment data should reflect the work force on board during all or any part of the last payroll period preceding the end of July.

III. NONSEGREGATED FACILITIES

This provision is applicable to all Federal-aid construction contracts and to all related construction subcontracts of \$10,000 or more.

The contractor must ensure that facilities provided for employees are provided in such a manner that segregation on the basis of race, color, religion, sex, or national origin cannot result. The contractor may neither require such segregated use by written or oral policies nor tolerate such use by employee custom. The contractor's obligation extends further to ensure that its employees are not assigned to perform their services at any location, under the contractor's control, where the facilities are segregated. The term "facilities" includes waiting rooms, work areas, restaurants and other eating areas, time clocks, restrooms, washrooms, locker rooms, and other storage or dressing areas, parking lots, drinking fountains, recreation or entertainment areas, transportation, and housing provided for employees. The contractor shall provide separate or single-user restrooms and necessary dressing or sleeping areas to assure privacy between sexes.

IV. DAVIS-BACON AND RELATED ACT PROVISIONS

This section is applicable to all Federal-aid construction projects exceeding \$2,000 and to all related subcontracts and lower-tier subcontracts (regardless of subcontract size). The requirements apply to all projects located within the right-of-way of a roadway that is functionally classified as Federal-aid highway. This excludes roadways functionally classified as local roads or rural minor collectors, which are exempt. Contracting agencies may elect to apply these requirements to other projects.

The following provisions are from the U.S. Department of Labor regulations in 29 CFR 5.5 "Contract provisions and related matters" with minor revisions to conform to the FHWA-1273 format and FHWA program requirements.

1. Minimum wages

a. All laborers and mechanics employed or working upon the site of the work, will be paid unconditionally and not less often than once a week, and without subsequent deduction or rebate on any account (except such payroll deductions as are permitted by regulations issued by the Secretary of Labor under the Copeland Act (29 CFR part 3)), the full amount of wages and bona fide fringe benefits (or cash equivalents thereof) due at time of payment computed at rates not less than those contained in the wage determination of the Secretary of Labor which is attached hereto and made a part hereof, regardless of any contractual relationship which may be alleged to exist between the contractor and such laborers and mechanics.

Contributions made or costs reasonably anticipated for bona fide fringe benefits under section 1(b)(2) of the Davis-Bacon Act on behalf of laborers or mechanics are considered wages paid to such laborers or mechanics, subject to the provisions of paragraph 1.d. of this section; also, regular contributions made or costs incurred for more than a weekly period (but not less often than quarterly) under plans, funds, or programs which cover the particular weekly period, are deemed to be constructively made or incurred during such weekly period. Such laborers and mechanics shall be paid the appropriate wage rate and fringe benefits on the wage determination for the classification of work actually performed, without regard to skill, except as provided in 29 CFR 5.5(a)(4). Laborers or mechanics performing work in more than one classification may be compensated at the rate specified for each classification for the time actually worked therein: Provided, That the employer's payroll records accurately set forth the time spent in each classification in which work is performed. The wage determination (including any additional classification and wage rates conformed under paragraph 1.b. of this section) and the Davis-Bacon poster (WH-1321) shall be posted at all times by the contractor and its subcontractors at the site of the work in a prominent and accessible place where it can be easily seen by the workers.

b. (1) The contracting officer shall require that any class of laborers or mechanics, including helpers, which is not listed in the wage determination and which is to be employed under the contract shall be classified in conformance with the wage determination. The contracting officer shall approve an additional classification and wage rate and fringe benefits therefore only when the following criteria have been met:

- (i) The work to be performed by the classification requested is not performed by a classification in the wage determination; and
- (ii) The classification is utilized in the area by the construction industry; and
- (iii) The proposed wage rate, including any bona fide fringe benefits, bears a reasonable relationship to the wage rates contained in the wage determination.

(2) If the contractor and the laborers and mechanics to be employed in the classification (if known), or their representatives, and the contracting officer agree on the classification and wage rate (including the amount designated for fringe benefits where appropriate), a report of the action taken shall be sent by the contracting officer to the Administrator of the Wage and Hour Division, Employment Standards Administration, U.S. Department of Labor, Washington, DC 20210. The Administrator, or an authorized representative, will approve, modify, or disapprove every additional classification action within 30 days of receipt and so advise the contracting officer or will notify the contracting officer within the 30-day period that additional time is necessary.

(3) In the event the contractor, the laborers or mechanics to be employed in the classification or their representatives, and the contracting officer do not agree on the proposed classification and wage rate (including the amount designated for fringe benefits, where appropriate), the contracting officer shall refer the questions, including the views of all interested parties and the recommendation of the contracting officer, to the Wage and Hour Administrator for determination. The Wage and Hour Administrator, or an authorized representative, will issue a determination within 30 days of receipt and so advise the contracting officer or will notify the contracting officer within the 30-day period that additional time is necessary.

(4) The wage rate (including fringe benefits where appropriate) determined pursuant to paragraphs 1.b.(2) or 1.b.(3) of this section, shall be paid to all workers performing work in the classification under this contract from the first day on which work is performed in the classification.

c. Whenever the minimum wage rate prescribed in the contract for a class of laborers or mechanics includes a fringe benefit which is not expressed as an hourly rate, the contractor shall either pay the benefit as stated in the wage determination or shall pay another bona fide fringe benefit or an hourly cash equivalent thereof.

d. If the contractor does not make payments to a trustee or other third person, the contractor may consider as part of the wages of any laborer or mechanic the amount of any costs reasonably anticipated in providing bona fide fringe benefits under a plan or program, Provided, That the Secretary of Labor has found, upon the written request of the contractor, that the applicable standards of the Davis-Bacon Act have been met. The Secretary of Labor may require the contractor to set aside in a separate account assets for the meeting of obligations under the plan or program.

2. Withholding

The contracting agency shall upon its own action or upon written request of an authorized representative of the Department of Labor, withhold or cause to be withheld from the contractor under this contract, or any other Federal contract with the same prime contractor, or any other federally-assisted contract subject to Davis-Bacon prevailing wage requirements, which is held by the same prime contractor, so much of the accrued payments or advances as may be considered necessary to pay laborers and mechanics, including apprentices, trainees, and helpers, employed by the contractor or any subcontractor the full amount of wages required by the contract. In the event of failure to pay any laborer or mechanic, including any apprentice, trainee, or helper, employed or working on the site of the work, all or part of the wages required by the contract, the contracting agency may, after written notice to the contractor, take such action as may be necessary to cause the suspension of any further payment, advance, or guarantee of funds until such violations have ceased.

3. Payrolls and basic records

a. Payrolls and basic records relating thereto shall be maintained by the contractor during the course of the work and preserved for a period of three years thereafter for all laborers and mechanics working at the site of the work. Such records shall contain the name, address, and social security number of each such worker, his or her correct classification, hourly rates of wages paid (including rates of contributions or costs anticipated for bona fide fringe benefits or cash equivalents thereof of the types described in section 1(b)(2)(B) of the Davis-Bacon Act),

daily and weekly number of hours worked, deductions made and actual wages paid. Whenever the Secretary of Labor has found under 29 CFR 5.5(a)(1)(iv) that the wages of any laborer or mechanic include the amount of any costs reasonably anticipated in providing benefits under a plan or program described in section 1(b)(2)(B) of the Davis-Bacon Act, the contractor shall maintain records which show that the commitment to provide such benefits is enforceable, that the plan or program is financially responsible, and that the plan or program has been communicated in writing to the laborers or mechanics affected, and records which show the costs anticipated or the actual cost incurred in providing such benefits. Contractors employing apprentices or trainees under approved programs shall maintain written evidence of the registration of apprenticeship programs and certification of trainee programs, the registration of the apprentices and trainees, and the ratios and wage rates prescribed in the applicable programs.

b. (1) The contractor shall submit weekly for each week in which any contract work is performed a copy of all payrolls to the contracting agency. The payrolls submitted shall set out accurately and completely all of the information required to be maintained under 29 CFR 5.5(a)(3)(i), except that full social security numbers and home addresses shall not be included on weekly transmittals. Instead the payrolls shall only need to include an individually identifying number for each employee (e.g. , the last four digits of the employee's social security number). The required weekly payroll information may be submitted in any form desired. Optional Form WH-347 is available for this purpose from the Wage and Hour Division Web site at <http://www.dol.gov/esa/whd/forms/wh347instr.htm> or its successor site. The prime contractor is responsible for the submission of copies of payrolls by all subcontractors. Contractors and subcontractors shall maintain the full social security number and current address of each covered worker, and shall provide them upon request to the contracting agency for transmission to the State DOT, the FHWA or the Wage and Hour Division of the Department of Labor for purposes of an investigation or audit of compliance with prevailing wage requirements. It is not a violation of this section for a prime contractor to require a subcontractor to provide addresses and social security numbers to the prime contractor for its own records, without weekly submission to the contracting agency..

(2) Each payroll submitted shall be accompanied by a "Statement of Compliance," signed by the contractor or subcontractor or his or her agent who pays or supervises the payment of the persons employed under the contract and shall certify the following:

(i) That the payroll for the payroll period contains the information required to be provided under §5.5 (a)(3)(ii) of Regulations, 29 CFR part 5, the appropriate information is being maintained under §5.5 (a)(3)(i) of Regulations, 29 CFR part 5, and that such information is correct and complete;

(ii) That each laborer or mechanic (including each helper, apprentice, and trainee) employed on the contract during the payroll period has been paid the full weekly wages earned, without rebate, either directly or indirectly, and that no deductions have been made either directly or indirectly from the full wages earned, other than permissible deductions as set forth in Regulations, 29 CFR part 3;

(iii) That each laborer or mechanic has been paid not less than the applicable wage rates and fringe benefits or cash equivalents for the classification of work performed, as specified in the applicable wage determination incorporated into the contract.

(3) The weekly submission of a properly executed certification set forth on the reverse side of Optional Form WH-347 shall satisfy the requirement for submission of the “Statement of Compliance” required by paragraph 3.b.(2) of this section.

(4) The falsification of any of the above certifications may subject the contractor or subcontractor to civil or criminal prosecution under section 1001 of title 18 and section 231 of title 31 of the United States Code.

c. The contractor or subcontractor shall make the records required under paragraph 3.a. of this section available for inspection, copying, or transcription by authorized representatives of the contracting agency, the State DOT, the FHWA, or the Department of Labor, and shall permit such representatives to interview employees during working hours on the job. If the contractor or subcontractor fails to submit the required records or to make them available, the FHWA may, after written notice to the contractor, the contracting agency or the State DOT, take such action as may be necessary to cause the suspension of any further payment, advance, or guarantee of funds. Furthermore, failure to submit the required records upon request or to make such records available may be grounds for debarment action pursuant to 29 CFR 5.12.

4. Apprentices and trainees

a. Apprentices (programs of the USDOL).

Apprentices will be permitted to work at less than the predetermined rate for the work they performed when they are employed pursuant to and individually registered in a bona fide apprenticeship program registered with the U.S. Department of Labor, Employment and Training Administration, Office of Apprenticeship Training, Employer and Labor Services, or with a State Apprenticeship Agency recognized by the Office, or if a person is employed in his or her first 90 days of probationary employment as an apprentice in such an apprenticeship program, who is not individually registered in the program, but who has been certified by the Office of Apprenticeship Training, Employer and Labor Services or a State Apprenticeship Agency (where appropriate) to be eligible for probationary employment as an apprentice.

The allowable ratio of apprentices to journeymen on the job site in any craft classification shall not be greater than the ratio permitted to the contractor as to the entire work force under the registered program. Any worker listed on a payroll at an apprentice wage rate, who is not registered or otherwise employed as stated above, shall be paid not less than the applicable wage rate on the wage determination for the classification of work actually performed. In addition, any apprentice performing work on the job site in excess of the ratio permitted under the registered program shall be paid not less than the applicable wage rate on the wage determination for the work actually performed. Where a contractor is performing construction on a project in a locality other than that in which its program is registered, the ratios and wage rates (expressed in percentages of the journeyman's hourly rate) specified in the contractor's or subcontractor's registered program shall be observed.

Every apprentice must be paid at not less than the rate specified in the registered program for the apprentice's level of progress, expressed as a percentage of the journeymen hourly rate specified in the applicable wage determination. Apprentices shall be paid fringe benefits in accordance with the provisions of the apprenticeship program. If the apprenticeship program does not specify fringe benefits, apprentices must be paid the full amount of fringe benefits listed on the wage determination for the applicable classification. If the Administrator determines that a

different practice prevails for the applicable apprentice classification, fringes shall be paid in accordance with that determination.

In the event the Office of Apprenticeship Training, Employer and Labor Services, or a State Apprenticeship Agency recognized by the Office, withdraws approval of an apprenticeship program, the contractor will no longer be permitted to utilize apprentices at less than the applicable predetermined rate for the work performed until an acceptable program is approved.

b. Trainees (programs of the USDOL).

Except as provided in 29 CFR 5.16, trainees will not be permitted to work at less than the predetermined rate for the work performed unless they are employed pursuant to and individually registered in a program which has received prior approval, evidenced by formal certification by the U.S. Department of Labor, Employment and Training Administration.

The ratio of trainees to journeymen on the job site shall not be greater than permitted under the plan approved by the Employment and Training Administration.

Every trainee must be paid at not less than the rate specified in the approved program for the trainee's level of progress, expressed as a percentage of the journeyman hourly rate specified in the applicable wage determination. Trainees shall be paid fringe benefits in accordance with the provisions of the trainee program. If the trainee program does not mention fringe benefits, trainees shall be paid the full amount of fringe benefits listed on the wage determination unless the Administrator of the Wage and Hour Division determines that there is an apprenticeship program associated with the corresponding journeyman wage rate on the wage determination which provides for less than full fringe benefits for apprentices. Any employee listed on the payroll at a trainee rate who is not registered and participating in a training plan approved by the Employment and Training Administration shall be paid not less than the applicable wage rate on the wage determination for the classification of work actually performed. In addition, any trainee performing work on the job site in excess of the ratio permitted under the registered program shall be paid not less than the applicable wage rate on the wage determination for the work actually performed.

In the event the Employment and Training Administration withdraws approval of a training program, the contractor will no longer be permitted to utilize trainees at less than the applicable predetermined rate for the work performed until an acceptable program is approved.

c. Equal employment opportunity. The utilization of apprentices, trainees and journeymen under this part shall be in conformity with the equal employment opportunity requirements of Executive Order 11246, as amended, and 29 CFR part 30.

d. Apprentices and Trainees (programs of the U.S. DOT).

Apprentices and trainees working under apprenticeship and skill training programs which have been certified by the Secretary of Transportation as promoting EEO in connection with Federal-aid highway construction programs are not subject to the requirements of paragraph 4 of this Section IV. The straight time hourly wage rates for apprentices and trainees under such programs will be established by the particular programs. The ratio of apprentices and trainees to journeymen shall not be greater than permitted by the terms of the particular program.

5. Compliance with Copeland Act requirements. The contractor shall comply with the requirements of 29 CFR part 3, which are incorporated by reference in this contract.

6. Subcontracts. The contractor or subcontractor shall insert Form FHWA-1273 in any subcontracts and also require the subcontractors to include Form FHWA-1273 in any lower tier subcontracts. The prime contractor shall be responsible for the compliance by any subcontractor or lower tier subcontractor with all the contract clauses in 29 CFR 5.5.

7. Contract termination: debarment. A breach of the contract clauses in 29 CFR 5.5 may be grounds for termination of the contract, and for debarment as a contractor and a subcontractor as provided in 29 CFR 5.12.

8. Compliance with Davis-Bacon and Related Act requirements. All rulings and interpretations of the Davis-Bacon and Related Acts contained in 29 CFR parts 1, 3, and 5 are herein incorporated by reference in this contract.

9. Disputes concerning labor standards. Disputes arising out of the labor standards provisions of this contract shall not be subject to the general disputes clause of this contract. Such disputes shall be resolved in accordance with the procedures of the Department of Labor set forth in 29 CFR parts 5, 6, and 7. Disputes within the meaning of this clause include disputes between the contractor (or any of its subcontractors) and the contracting agency, the U.S. Department of Labor, or the employees or their representatives.

10. Certification of eligibility.

a. By entering into this contract, the contractor certifies that neither it (nor he or she) nor any person or firm who has an interest in the contractor's firm is a person or firm ineligible to be awarded Government contracts by virtue of section 3(a) of the Davis-Bacon Act or 29 CFR 5.12(a)(1).

b. No part of this contract shall be subcontracted to any person or firm ineligible for award of a Government contract by virtue of section 3(a) of the Davis-Bacon Act or 29 CFR 5.12(a)(1).

c. The penalty for making false statements is prescribed in the U.S. Criminal Code, 18 U.S.C. 1001.

V. CONTRACT WORK HOURS AND SAFETY STANDARDS ACT

The following clauses apply to any Federal-aid construction contract in an amount in excess of \$100,000 and subject to the overtime provisions of the Contract Work Hours and Safety Standards Act. These clauses shall be inserted in addition to the clauses required by 29 CFR 5.5(a) or 29 CFR 4.6. As used in this paragraph, the terms laborers and mechanics include watchmen and guards.

1. Overtime requirements. No contractor or subcontractor contracting for any part of the contract work which may require or involve the employment of laborers or mechanics shall require or permit any such laborer or mechanic in any workweek in which he or she is employed on such work to work in excess of forty hours in such workweek unless such laborer or mechanic receives compensation at a rate not less than one and one-half times the basic rate of pay for all hours worked in excess of forty hours in such workweek.

2. Violation; liability for unpaid wages; liquidated damages. In the event of any violation of the clause set forth in paragraph (1.) of this section, the contractor and any subcontractor responsible therefor shall be liable for the unpaid wages. In addition, such contractor and subcontractor shall be liable to the United States (in the case of work done under contract for the District of Columbia or a territory, to such District or to such territory), for liquidated damages. Such liquidated damages shall be computed with respect to each individual laborer or mechanic, including watchmen and guards, employed in violation of the clause set forth in paragraph (1.) of this section, in the sum of \$10 for each calendar day on which such individual was required or permitted to work in excess of the standard workweek of forty hours without payment of the overtime wages required by the clause set forth in paragraph (1.) of this section.

3. Withholding for unpaid wages and liquidated damages. The FHWA or the contacting agency shall upon its own action or upon written request of an authorized representative of the Department of Labor withhold or cause to be withheld, from any moneys payable on account of work performed by the contractor or subcontractor under any such contract or any other Federal contract with the same prime contractor, or any other federally-assisted contract subject to the Contract Work Hours and Safety Standards Act, which is held by the same prime contractor, such sums as may be determined to be necessary to satisfy any liabilities of such contractor or subcontractor for unpaid wages and liquidated damages as provided in the clause set forth in paragraph (2.) of this section.

4. Subcontracts. The contractor or subcontractor shall insert in any subcontracts the clauses set forth in paragraph (1.) through (4.) of this section and also a clause requiring the subcontractors to include these clauses in any lower tier subcontracts. The prime contractor shall be responsible for compliance by any subcontractor or lower tier subcontractor with the clauses set forth in paragraphs (1.) through (4.) of this section.

VI. SUBLETTING OR ASSIGNING THE CONTRACT

This provision is applicable to all Federal-aid construction contracts on the National Highway System.

1. The contractor shall perform with its own organization contract work amounting to not less than 30 percent (or a greater percentage if specified elsewhere in the contract) of the total original contract price, excluding any specialty items designated by the contracting agency. Specialty items may be performed by subcontract and the amount of any such specialty items performed may be deducted from the total original contract price before computing the amount of work required to be performed by the contractor's own organization (23 CFR 635.116).

a. The term “perform work with its own organization” refers to workers employed or leased by the prime contractor, and equipment owned or rented by the prime contractor, with or without operators. Such term does not include employees or equipment of a subcontractor or lower tier subcontractor, agents of the prime contractor, or any other assignees. The term may include payments for the costs of hiring leased employees from an employee leasing firm meeting all relevant Federal and State regulatory requirements. Leased employees may only be included in this term if the prime contractor meets all of the following conditions:

- (1) the prime contractor maintains control over the supervision of the day-to-day activities of the leased employees;
- (2) the prime contractor remains responsible for the quality of the work of the leased employees;
- (3) the prime contractor retains all power to accept or exclude individual employees from work on the project; and
- (4) the prime contractor remains ultimately responsible for the payment of predetermined minimum wages, the submission of payrolls, statements of compliance and all other Federal regulatory requirements.

b. "Specialty Items" shall be construed to be limited to work that requires highly specialized knowledge, abilities, or equipment not ordinarily available in the type of contracting organizations qualified and expected to bid or propose on the contract as a whole and in general are to be limited to minor components of the overall contract.

2. The contract amount upon which the requirements set forth in paragraph (1) of Section VI is computed includes the cost of material and manufactured products which are to be purchased or produced by the contractor under the contract provisions.

3. The contractor shall furnish (a) a competent superintendent or supervisor who is employed by the firm, has full authority to direct performance of the work in accordance with the contract requirements, and is in charge of all construction operations (regardless of who performs the work) and (b) such other of its own organizational resources (supervision, management, and engineering services) as the contracting officer determines is necessary to assure the performance of the contract.

4. No portion of the contract shall be sublet, assigned or otherwise disposed of except with the written consent of the contracting officer, or authorized representative, and such consent when given shall not be construed to relieve the contractor of any responsibility for the fulfillment of the contract. Written consent will be given only after the contracting agency has assured that each subcontract is evidenced in writing and that it contains all pertinent provisions and requirements of the prime contract.

5. The 30% self-performance requirement of paragraph (1) is not applicable to design-build contracts; however, contracting agencies may establish their own self-performance requirements.

VII. SAFETY: ACCIDENT PREVENTION

This provision is applicable to all Federal-aid construction contracts and to all related subcontracts.

1. In the performance of this contract the contractor shall comply with all applicable Federal, State, and local laws governing safety, health, and sanitation (23 CFR 635). The contractor shall provide all safeguards, safety devices and protective equipment and take any other needed actions as it determines, or as the contracting officer may determine, to be reasonably necessary to protect the life and health of employees on the job and the safety of the public and to protect property in connection with the performance of the work covered by the contract.

2. It is a condition of this contract, and shall be made a condition of each subcontract, which the contractor enters into pursuant to this contract, that the contractor and any subcontractor shall not permit any employee, in performance of the contract, to work in surroundings or under conditions which are unsanitary, hazardous or dangerous to his/her health or safety, as determined under construction safety and health standards (29 CFR 1926) promulgated by the Secretary of Labor, in accordance with Section 107 of the Contract Work Hours and Safety Standards Act (40 U.S.C. 3704).

3. Pursuant to 29 CFR 1926.3, it is a condition of this contract that the Secretary of Labor or authorized representative thereof, shall have right of entry to any site of contract performance to inspect or investigate the matter of compliance with the construction safety and health standards and to carry out the duties of the Secretary under Section 107 of the Contract Work Hours and Safety Standards Act (40 U.S.C.3704).

VIII. FALSE STATEMENTS CONCERNING HIGHWAY PROJECTS

This provision is applicable to all Federal-aid construction contracts and to all related subcontracts.

In order to assure high quality and durable construction in conformity with approved plans and specifications and a high degree of reliability on statements and representations made by engineers, contractors, suppliers, and workers on Federal-aid highway projects, it is essential that all persons concerned with the project perform their functions as carefully, thoroughly, and honestly as possible. Willful falsification, distortion, or misrepresentation with respect to any facts related to the project is a violation of Federal law. To prevent any misunderstanding regarding the seriousness of these and similar acts, Form FHWA-1022 shall be posted on each Federal-aid highway project (23 CFR 635) in one or more places where it is readily available to all persons concerned with the project:

18 U.S.C. 1020 reads as follows:

"Whoever, being an officer, agent, or employee of the United States, or of any State or Territory, or whoever, whether a person, association, firm, or corporation, knowingly makes any false statement, false representation, or false report as to the character, quality, quantity, or cost of the material used or to be used, or the quantity or quality of the work performed or to be performed, or the cost thereof in connection with the submission of plans, maps, specifications, contracts, or costs of construction on any highway or related project submitted for approval to the Secretary of Transportation; or

Whoever knowingly makes any false statement, false representation, false report or false claim with respect to the character, quality, quantity, or cost of any work performed or to be performed, or materials furnished or to be furnished, in connection with the construction of any highway or related project approved by the Secretary of Transportation; or

Whoever knowingly makes any false statement or false representation as to material fact in any statement, certificate, or report submitted pursuant to provisions of the Federal-aid Roads Act approved July 1, 1916, (39 Stat. 355), as amended and supplemented;

Shall be fined under this title or imprisoned not more than 5 years or both."

IX. IMPLEMENTATION OF CLEAN AIR ACT AND FEDERAL WATER POLLUTION CONTROL ACT

This provision is applicable to all Federal-aid construction contracts and to all related subcontracts.

By submission of this bid/proposal or the execution of this contract, or subcontract, as appropriate, the bidder, proposer, Federal-aid construction contractor, or subcontractor, as appropriate, will be deemed to have stipulated as follows:

1. That any person who is or will be utilized in the performance of this contract is not prohibited from receiving an award due to a violation of Section 508 of the Clean Water Act or Section 306 of the Clean Air Act.
2. That the contractor agrees to include or cause to be included the requirements of paragraph (1) of this Section X in every subcontract, and further agrees to take such action as the contracting agency may direct as a means of enforcing such requirements.

X. CERTIFICATION REGARDING DEBARMENT, SUSPENSION, INELIGIBILITY AND VOLUNTARY EXCLUSION

This provision is applicable to all Federal-aid construction contracts, design-build contracts, subcontracts, lower-tier subcontracts, purchase orders, lease agreements, consultant contracts or any other covered transaction requiring FHWA approval or that is estimated to cost \$25,000 or more – as defined in 2 CFR Parts 180 and 1200.

1. Instructions for Certification – First Tier Participants:

- a. By signing and submitting this proposal, the prospective first tier participant is providing the certification set out below.
- b. The inability of a person to provide the certification set out below will not necessarily result in denial of participation in this covered transaction. The prospective first tier participant shall submit an explanation of why it cannot provide the certification set out below. The certification or explanation will be considered in connection with the department or agency's determination whether to enter into this transaction. However, failure of the prospective first tier participant to furnish a certification or an explanation shall disqualify such a person from participation in this transaction.
- c. The certification in this clause is a material representation of fact upon which reliance was placed when the contracting agency determined to enter into this transaction. If it is later determined that the prospective participant knowingly rendered an erroneous certification, in addition to other remedies available to the Federal Government, the contracting agency may terminate this transaction for cause of default.

d. The prospective first tier participant shall provide immediate written notice to the contracting agency to whom this proposal is submitted if any time the prospective first tier participant learns that its certification was erroneous when submitted or has become erroneous by reason of changed circumstances.

e. The terms "covered transaction," "debarred," "suspended," "ineligible," "participant," "person," "principal," and "voluntarily excluded," as used in this clause, are defined in 2 CFR Parts 180 and 1200. "First Tier Covered Transactions" refers to any covered transaction between a grantee or subgrantee of Federal funds and a participant (such as the prime or general contract). "Lower Tier Covered Transactions" refers to any covered transaction under a First Tier Covered Transaction (such as subcontracts). "First Tier Participant" refers to the participant who has entered into a covered transaction with a grantee or subgrantee of Federal funds (such as the prime or general contractor). "Lower Tier Participant" refers any participant who has entered into a covered transaction with a First Tier Participant or other Lower Tier Participants (such as subcontractors and suppliers).

f. The prospective first tier participant agrees by submitting this proposal that, should the proposed covered transaction be entered into, it shall not knowingly enter into any lower tier covered transaction with a person who is debarred, suspended, declared ineligible, or voluntarily excluded from participation in this covered transaction, unless authorized by the department or agency entering into this transaction.

g. The prospective first tier participant further agrees by submitting this proposal that it will include the clause titled "Certification Regarding Debarment, Suspension, Ineligibility and Voluntary Exclusion-Lower Tier Covered Transactions," provided by the department or contracting agency, entering into this covered transaction, without modification, in all lower tier covered transactions and in all solicitations for lower tier covered transactions exceeding the \$25,000 threshold.

h. A participant in a covered transaction may rely upon a certification of a prospective participant in a lower tier covered transaction that is not debarred, suspended, ineligible, or voluntarily excluded from the covered transaction, unless it knows that the certification is erroneous. A participant is responsible for ensuring that its principals are not suspended, debarred, or otherwise ineligible to participate in covered transactions. To verify the eligibility of its principals, as well as the eligibility of any lower tier prospective participants, each participant may, but is not required to, check the Excluded Parties List System website (<https://www.epls.gov/>), which is compiled by the General Services Administration.

i. Nothing contained in the foregoing shall be construed to require the establishment of a system of records in order to render in good faith the certification required by this clause. The knowledge and information of the prospective participant is not required to exceed that which is normally possessed by a prudent person in the ordinary course of business dealings.

j. Except for transactions authorized under paragraph (f) of these instructions, if a participant in a covered transaction knowingly enters into a lower tier covered transaction with a person who is suspended, debarred, ineligible, or voluntarily excluded from participation in this transaction, in addition to other remedies available to the Federal Government, the department or agency may terminate this transaction for cause or default.

* * * * *

2. Certification Regarding Debarment, Suspension, Ineligibility and Voluntary Exclusion – First Tier Participants:

a. The prospective first tier participant certifies to the best of its knowledge and belief, that it and its principals:

(1) Are not presently debarred, suspended, proposed for debarment, declared ineligible, or voluntarily excluded from participating in covered transactions by any Federal department or agency;

(2) Have not within a three-year period preceding this proposal been convicted of or had a civil judgment rendered against them for commission of fraud or a criminal offense in connection with obtaining, attempting to obtain, or performing a public (Federal, State or local) transaction or contract under a public transaction; violation of Federal or State antitrust statutes or commission of embezzlement, theft, forgery, bribery, falsification or destruction of records, making false statements, or receiving stolen property;

(3) Are not presently indicted for or otherwise criminally or civilly charged by a governmental entity (Federal, State or local) with commission of any of the offenses enumerated in paragraph (a)(2) of this certification; and

(4) Have not within a three-year period preceding this application/proposal had one or more public transactions (Federal, State or local) terminated for cause or default.

b. Where the prospective participant is unable to certify to any of the statements in this certification, such prospective participant shall attach an explanation to this proposal.

2. Instructions for Certification - Lower Tier Participants:

(Applicable to all subcontracts, purchase orders and other lower tier transactions requiring prior FHWA approval or estimated to cost \$25,000 or more - 2 CFR Parts 180 and 1200)

a. By signing and submitting this proposal, the prospective lower tier is providing the certification set out below.

b. The certification in this clause is a material representation of fact upon which reliance was placed when this transaction was entered into. If it is later determined that the prospective lower tier participant knowingly rendered an erroneous certification, in addition to other remedies available to the Federal Government, the department, or agency with which this transaction originated may pursue available remedies, including suspension and/or debarment.

c. The prospective lower tier participant shall provide immediate written notice to the person to which this proposal is submitted if at any time the prospective lower tier participant learns that its certification was erroneous by reason of changed circumstances.

d. The terms "covered transaction," "debarred," "suspended," "ineligible," "participant," "person," "principal," and "voluntarily excluded," as used in this clause, are defined in 2 CFR Parts 180 and 1200. You may contact the person to which this proposal is submitted for assistance in obtaining a copy of those regulations. "First Tier Covered Transactions" refers to any covered transaction between a grantee or subgrantee of Federal funds and a participant (such as the prime or general contract). "Lower Tier Covered Transactions" refers to any covered transaction under a First Tier Covered Transaction (such as subcontracts). "First Tier Participant" refers to the participant who has entered into a covered transaction with a grantee or subgrantee of Federal funds (such as the prime or general contractor). "Lower Tier Participant" refers any participant who has entered into a covered transaction with a First Tier Participant or other Lower Tier Participants (such as subcontractors and suppliers).

e. The prospective lower tier participant agrees by submitting this proposal that, should the proposed covered transaction be entered into, it shall not knowingly enter into any lower tier covered transaction with a person who is debarred, suspended, declared ineligible, or voluntarily excluded from participation in this covered transaction, unless authorized by the department or agency with which this transaction originated.

f. The prospective lower tier participant further agrees by submitting this proposal that it will include this clause titled "Certification Regarding Debarment, Suspension, Ineligibility and Voluntary Exclusion-Lower Tier Covered Transaction," without modification, in all lower tier covered transactions and in all solicitations for lower tier covered transactions exceeding the \$25,000 threshold.

g. A participant in a covered transaction may rely upon a certification of a prospective participant in a lower tier covered transaction that is not debarred, suspended, ineligible, or voluntarily excluded from the covered transaction, unless it knows that the certification is erroneous. A participant is responsible for ensuring that its principals are not suspended, debarred, or otherwise ineligible to participate in covered transactions. To verify the eligibility of its principals, as well as the eligibility of any lower tier prospective participants, each participant may, but is not required to, check the Excluded Parties List System website (<https://www.epls.gov/>), which is compiled by the General Services Administration.

h. Nothing contained in the foregoing shall be construed to require establishment of a system of records in order to render in good faith the certification required by this clause. The knowledge and information of participant is not required to exceed that which is normally possessed by a prudent person in the ordinary course of business dealings.

i. Except for transactions authorized under paragraph e of these instructions, if a participant in a covered transaction knowingly enters into a lower tier covered transaction with a person who is suspended, debarred, ineligible, or voluntarily excluded from participation in this transaction, in addition to other remedies available to the Federal Government, the department or agency with which this transaction originated may pursue available remedies, including suspension and/or debarment.

* * * * *

**Certification Regarding Debarment, Suspension, Ineligibility and Voluntary Exclusion--
Lower Tier Participants:**

1. The prospective lower tier participant certifies, by submission of this proposal, that neither it nor its principals is presently debarred, suspended, proposed for debarment, declared ineligible, or voluntarily excluded from participating in covered transactions by any Federal department or agency.

2. Where the prospective lower tier participant is unable to certify to any of the statements in this certification, such prospective participant shall attach an explanation to this proposal.

XI. CERTIFICATION REGARDING USE OF CONTRACT FUNDS FOR LOBBYING

This provision is applicable to all Federal-aid construction contracts and to all related subcontracts which exceed \$100,000 (49 CFR 20).

1. The prospective participant certifies, by signing and submitting this bid or proposal, to the best of his or her knowledge and belief, that:

a. No Federal appropriated funds have been paid or will be paid, by or on behalf of the undersigned, to any person for influencing or attempting to influence an officer or employee of any Federal agency, a Member of Congress, an officer or employee of Congress, or an employee of a Member of Congress in connection with the awarding of any Federal contract, the making of any Federal grant, the making of any Federal loan, the entering into of any cooperative agreement, and the extension, continuation, renewal, amendment, or modification of any Federal contract, grant, loan, or cooperative agreement.

b. If any funds other than Federal appropriated funds have been paid or will be paid to any person for influencing or attempting to influence an officer or employee of any Federal agency, a Member of Congress, an officer or employee of Congress, or an employee of a Member of Congress in connection with this Federal contract, grant, loan, or cooperative agreement, the undersigned shall complete and submit Standard Form-LLL, "Disclosure Form to Report Lobbying," in accordance with its instructions.

2. This certification is a material representation of fact upon which reliance was placed when this transaction was made or entered into. Submission of this certification is a prerequisite for making or entering into this transaction imposed by 31 U.S.C. 1352. Any person who fails to file the required certification shall be subject to a civil penalty of not less than \$10,000 and not more than \$100,000 for each such failure.

3. The prospective participant also agrees by submitting its bid or proposal that the participant shall require that the language of this certification be included in all lower tier subcontracts, which exceed \$100,000 and that all such recipients shall certify and disclose accordingly.

**ATTACHMENT A - EMPLOYMENT AND MATERIALS PREFERENCE FOR
APPALACHIAN DEVELOPMENT HIGHWAY SYSTEM OR APPALACHIAN LOCAL
ACCESS ROAD CONTRACTS**

This provision is applicable to all Federal-aid projects funded under the Appalachian Regional Development Act of 1965.

1. During the performance of this contract, the contractor undertaking to do work which is, or reasonably may be, done as on-site work, shall give preference to qualified persons who regularly reside in the labor area as designated by the DOL wherein the contract work is situated, or the subregion, or the Appalachian counties of the State wherein the contract work is situated, except:

a. To the extent that qualified persons regularly residing in the area are not available.

b. For the reasonable needs of the contractor to employ supervisory or specially experienced personnel necessary to assure an efficient execution of the contract work.

c. For the obligation of the contractor to offer employment to present or former employees as the result of a lawful collective bargaining contract, provided that the number of nonresident persons employed under this subparagraph (1c) shall not exceed 20 percent of the total number of employees employed by the contractor on the contract work, except as provided in subparagraph (4) below.

2. The contractor shall place a job order with the State Employment Service indicating (a) the classifications of the laborers, mechanics and other employees required to perform the contract work, (b) the number of employees required in each classification, (c) the date on which the participant estimates such employees will be required, and (d) any other pertinent information required by the State Employment Service to complete the job order form. The job order may be placed with the State Employment Service in writing or by telephone. If during the course of the contract work, the information submitted by the contractor in the original job order is substantially modified, the participant shall promptly notify the State Employment Service.

3. The contractor shall give full consideration to all qualified job applicants referred to him by the State Employment Service. The contractor is not required to grant employment to any job applicants who, in his opinion, are not qualified to perform the classification of work required.

4. If, within one week following the placing of a job order by the contractor with the State Employment Service, the State Employment Service is unable to refer any qualified job applicants to the contractor, or less than the number requested, the State Employment Service will forward a certificate to the contractor indicating the unavailability of applicants. Such certificate shall be made a part of the contractor's permanent project records. Upon receipt of this certificate, the contractor may employ persons who do not normally reside in the labor area to fill positions covered by the certificate, notwithstanding the provisions of subparagraph (1c) above.

5. The provisions of 23 CFR 633.207(e) allow the contracting agency to provide a contractual preference for the use of mineral resource materials native to the Appalachian region.

6. The contractor shall include the provisions of Sections 1 through 4 of this Attachment A in every subcontract for work which is, or reasonably may be, done as on-site work.

End of FHWA 1273

**The United States Department of Transportation (USDOT) Standard Title VI/Non-Discrimination
Assurances**

DOT Order No. 1050.2A

The **Maine Department of Transportation** (herein referred to as the "Recipient"), **HEREBY AGREES THAT**, as a condition to receiving any Federal financial assistance from the U.S. Department of Transportation (DOT), through the **Federal Highway Administration (FHWA)**, is subject to and will comply with the following:

Statutory/Regulatory Authorities

- Title VI of the Civil Rights Act of 1964 (42 U.S.C. § 2000d et seq., 78 stat. 252), (prohibits discrimination on the basis of race, color, national origin);
- 49 C.F.R. Part 21 (entitled Non-discrimination In Federally-Assisted Programs Of The Department Of Transportation-Effectuation Of Title VI Of The Civil Rights Act Of 1964);
- 28 C.F.R. Section 50.3 (U.S. Department of Justice Guidelines for Enforcement of Title VI of the Civil Rights Act of 1964);

The preceding statutory and regulatory cites hereinafter are referred to as the "Acts" and "Regulations," respectively.

General Assurances

In accordance with the Acts, the Regulations, and other pertinent directives, circulars, policy, memoranda, and/or guidance, the Recipient hereby gives assurance that it will promptly take any measures necessary to ensure that:

"No person in the United States shall, on the grounds of race, color, or national origin, be excluded from participation in, be denied the benefits of, or be otherwise subjected to discrimination under any program or activity, "for which the Recipient receives Federal financial assistance from DOT, including the FHWA.

The Civil Rights Restoration Act of 1987 clarified the original intent of Congress, with respect to Title VI and other Non-discrimination requirements (The Age Discrimination Act of 1975, and Section 504 of the Rehabilitation Act of 1973), by restoring the broad, institutional-wide scope and coverage of these non-discrimination statutes and requirements to include all programs and activities of the Recipient, so long as any portion of the program is Federally assisted.

Specific Assurances

More specifically, and without limiting the above general Assurance, the Recipient agrees with and gives the following Assurances with respect to its Federally assisted **Highway Program**:

1. The Recipient agrees that each "activity," "facility," or "program," as defined in §§ 21.23(b) and 21.23(e) of 49 C.F.R. § 21 will be (with regard to an "activity") facilitated, or will be (with regard

to a "facility") operated, or will be (with regard to a "program") conducted in compliance with all requirements imposed by, or pursuant to the Acts and the Regulations.

2. The Recipient will insert the following notification in all solicitations for bids, Requests For Proposals for work, or material subject to the Acts and the Regulations made in connection with all **Federal-Aid Highway Program activities** and, in adapted form, in all proposals for negotiated agreements regardless of funding source:

"The **Maine Department of Transportation**, in accordance with the provisions of Title VI of the Civil Rights Act of 1964 (78 Stat. 252, 42 U.S.C. §§ 2000d to 2000d-4) and the Regulations, hereby notifies all bidders that it will affirmatively ensure that any contract entered into pursuant to this advertisement, disadvantaged business enterprises will be afforded full and fair opportunity to submit bids in response to this invitation and will not be discriminated against on the grounds of race, color, or national origin in consideration for an award."

3. The Recipient will insert the clauses of Appendix A and E of this Assurance in every contract or agreement subject to the Acts and the Regulations.
4. The Recipient will insert the clauses of Appendix B of this Assurance, as a covenant running with the land, in any deed from the United States effecting or recording a transfer of real property, structures, use, or improvements thereon or interest therein to a Recipient.
5. That where the Recipient receives Federal financial assistance to construct a facility, or part of a facility, the Assurance will extend to the entire facility and facilities operated in connection therewith.
6. That where the Recipient receives Federal financial assistance in the form, or for the acquisition of real property or an interest in real property, the Assurance will extend to rights to space on, over, or under such property.
7. That the Recipient will include the clauses set forth in Appendix C and Appendix D of this Assurance, as a covenant running with the land, in any future deeds, leases, licenses, permits, or similar instruments entered into by the Recipient with other parties:
 - a. for the subsequent transfer of real property acquired or improved under the applicable activity, project, or program; and
 - b. for the construction or use of, or access to, space on, over, or under real property acquired or improved under the applicable activity, project, or program.
8. That this Assurance obligates the Recipient for the period during which Federal financial assistance is extended to the program, except where the Federal financial assistance is to provide, or is in the form of, personal property, or real property, or interest therein, or structures or improvements thereon, in which case the Assurance obligates the Recipient, or any transferee for the longer of the following periods:

- a. the period during which the property is used for a purpose for which the Federal financial assistance is extended, or for another purpose involving the provision of similar services or benefits; or
 - b. the period during which the Recipient retains ownership or possession of the property.
9. The Recipient will provide for such methods of administration for the program as are found by the Secretary of Transportation or the official to whom he/she delegates specific authority to give reasonable guarantee that it, other recipients, sub-recipients, sub-grantees, contractors, subcontractors, consultants, transferees, successors in interest, and other participants of Federal financial assistance under such program will comply with all requirements imposed or pursuant to the Acts, the Regulations, and this Assurance.
10. The Recipient agrees that the United States has a right to seek judicial enforcement with regard to any matter arising under the Acts, the Regulations, and this Assurance.

By signing this ASSURANCE, the **Maine Department of Transportation** also agrees to comply (and require any sub-recipients, sub-grantees, contractors, successors, transferees, and/or assignees to comply) with all applicable provisions governing the **FHWA and USDOT** access to records, accounts, documents, information, facilities, and staff. You also recognize that you must comply with any program or compliance reviews, and/or complaint investigations conducted by the **FHWA and USDOT**. You must keep records, reports, and submit the material for review upon request to **FHWA and USDOT**, or its designee in a timely, complete, and accurate way. Additionally, you must comply with all other reporting, data collection, and evaluation requirements, as prescribed by law or detailed in program guidance.

The **Maine Department of Transportation** gives this ASSURANCE in consideration of and for obtaining any Federal grants, loans, contracts, agreements, property, and/or discounts, or other Federal-aid and Federal financial assistance extended after the date hereof to the recipients by the U.S. Department of Transportation under the **Federal Aid Highway Program**. This ASSURANCE is binding on [*insert State*], other recipients, sub-recipients, sub-grantees, contractors, subcontractors and their subcontractors', transferees, successors in interest, and any other participants in the **Federal Aid Highway Program**. The person(s) signing below is authorized to sign this ASSURANCE on behalf of the Recipient.

MAINE DEPARTMENT OF TRANSPORTATION
(Name of Recipient)

by 
Bruce A. Van Note, Commissioner

DATED 2/13/19

APPENDIX A

During the performance of this contract, the contractor, for itself, its assignees, and successors in interest (hereinafter referred to as the "contractor") agrees as follows:

1. **Compliance with Regulations:** The contractor (hereinafter includes consultants) will comply with the Acts and the Regulations relative to Non-discrimination in Federally-assisted programs of the U.S. Department of Transportation, *Federal Highway Administration (FHWA)*, as they may be amended from time to time, which are herein incorporated by reference and made a part of this contract.
2. **Non-discrimination:** The contractor, with regard to the work performed by it during the contract, will not discriminate on the grounds of race, color, or national origin in the selection and retention of subcontractors, including procurements of materials and leases of equipment. The contractor will not participate directly or indirectly in the discrimination prohibited by the Acts and the Regulations, including employment practices when the contract covers any activity, project, or program set forth in Appendix B of 49 CFR Part 21.
3. **Solicitations for Subcontracts, Including Procurements of Materials and Equipment:** In all solicitations, either by competitive bidding, or negotiation made by the contractor for work to be performed under a subcontract, including procurements of materials, or leases of equipment, each potential subcontractor or supplier will be notified by the contractor of the contractor's obligations under this contract and the Acts and the Regulations relative to Non-discrimination on the grounds of race, color, or national origin.
4. **Information and Reports:** The contractor will provide all information and reports required by the Acts, the Regulations, and directives issued pursuant thereto and will permit access to its books, records, accounts, other sources of information, and its facilities as may be determined by the Recipient or the *FHWA* to be pertinent to ascertain compliance with such Acts, Regulations, and instructions. Where any information required of a contractor is in the exclusive possession of another who fails or refuses to furnish the information, the contractor will so certify to the Recipient or the *FHWA*, as appropriate, and will set forth what efforts it has made to obtain the information.
5. **Sanctions for Noncompliance:** In the event of a contractor's noncompliance with the Non discrimination provisions of this contract, the Recipient will impose such contract sanctions as it or the *FHWA* may determine to be appropriate, including, but not limited to:
 - a. withholding payments to the contractor under the contract until the contractor complies; and/or
 - b. cancelling, terminating, or suspending a contract, in whole or in part.
6. **Incorporation of Provisions:** The contractor will include the provisions of paragraphs one through six in every subcontract, including procurements of materials and leases of equipment, unless exempt by the Acts, the Regulations and directives issued pursuant thereto. The contractor will take action with respect to any subcontract or procurement as the Recipient or the *FHWA* may direct as a means of enforcing such provisions including sanctions for

noncompliance. Provided, that if the contractor becomes involved in, or is threatened with litigation by a subcontractor, or supplier because of such direction, the contractor may request the Recipient to enter into any litigation to protect the interests of the Recipient. In addition, the contractor may request the United States to enter into the litigation to protect the interests of the United States.

APPENDIX B

CLAUSES FOR DEEDS TRANSFERRING UNITED STATES PROPERTY

The following clauses will be included in deeds effecting or recording the transfer of real property, structures, or improvements thereon, or granting interest therein from the United States pursuant to the provisions of Assurance 4:

NOW, THEREFORE, the U.S. Department of Transportation as authorized by law and upon the condition that the **Maine Department of Transportation** will accept title to the lands and maintain the project constructed thereon in accordance with **23 U.S. Code § 107**, the Regulations for the Administration of **the Federal Aid Highway Program**, and the policies and procedures prescribed by the **FHWA** of the U.S. Department of Transportation in accordance and in compliance with all requirements imposed by Title 49, Code of Federal Regulations, U.S. Department of Transportation, Subtitle A, Office of the Secretary, Part 21, Non-discrimination in Federally-assisted programs of the U.S. Department of Transportation pertaining to and effectuating the provisions of Title VI of the Civil Rights Act of 1964 (78 Stat. 252; 42 U.S.C. § 2000d to 2000d-4), does hereby remise, release, quitclaim and convey unto the **Maine Department of Transportation** all the right, title and interest of the U.S. Department of Transportation in and to said lands described in Exhibit A attached hereto and made a part hereof.

(HABENDUM CLAUSE)

TO HAVE AND TO HOLD said lands and interests therein unto **Maine Department of Transportation** and its successors forever, subject, however, to the covenants, conditions, restrictions and reservations herein contained as follows, which will remain in effect for the period during which the real property or structures are used for a purpose for which Federal financial assistance is extended or for another purpose involving the provision of similar services or benefits and will be binding on the **Maine Department of Transportation**, its successors and assigns.

The **Maine Department of Transportation**, in consideration of the conveyance of said lands and interests in lands, does hereby covenant and agree as a covenant running with the land for itself, its successors and assigns, that (1) no person will on the grounds of race, color, or national origin, be excluded from participation in, be denied the benefits of, or be otherwise subjected to discrimination with regard to any facility located wholly or in part on, over, or under such lands hereby conveyed [,] [and]* (2) that the **Maine Department of Transportation** will use the lands and interests in lands and interests in lands so conveyed, in compliance with all requirements imposed by or pursuant to Title 49, Code of Federal Regulations, U.S. Department of Transportation, Subtitle A, Office of the Secretary, Part 21, Nondiscrimination in Federally-assisted programs of the U.S. Department of Transportation, Effectuation of Title VI of the Civil Rights Act of 1964, and as said Regulations and Acts may be amended [, and (3) that in the event of breach of any of the above-mentioned non-discrimination conditions, the Department will have a right to enter or re-enter said lands and facilities on said land, and that above described land and facilities will thereon revert to and vest in and become the absolute property of the U.S. Department of Transportation and its assigns as such interest existed prior to this instruction].*

(*Reverter clause and related language to be used only when it is determined that such a clause is necessary in order to make clear the purpose of Title VI.)

APPENDIX C

CLAUSES FOR TRANSFER OF REAL PROPERTY ACQUIRED OR IMPROVED UNDER THE ACTIVITY, FACILITY, OR PROGRAM

The following clauses will be included in deeds, licenses, leases, permits, or similar instruments entered into by the **Maine Department of Transportation** pursuant to the provisions of Assurance 7(a):

- A. The (grantee, lessee, permittee, etc. as appropriate) for himself/herself, his/her heirs, personal representatives, successors in interest, and assigns, as a part of the consideration hereof, does hereby covenant and agree [in the case of deeds and leases add "as a covenant running with the land"] that:
 1. In the event facilities are constructed, maintained, or otherwise operated on the property described in this (deed, license, lease, permit, etc.) for a purpose for which a U.S. Department of Transportation activity, facility, or program is extended or for another purpose involving the provision of similar services or benefits, the (grantee, licensee, lessee, permittee, etc.) will maintain and operate such facilities and services in compliance with all requirements imposed by the Acts and Regulations (as may be amended) such that no person on the grounds of race, color, or national origin, will be excluded from participation in, denied the benefits of, or be otherwise subjected to discrimination in the use of said facilities.
- B. With respect to licenses, leases, permits, etc., in the event of breach of any of the above Non-discrimination covenants, **Maine Department of Transportation** will have the right to terminate the (lease, license, permit, etc.) and to enter, re-enter, and repossess said lands and facilities thereon, and hold the same as if the (lease, license, permit, etc.) had never been made or issued.*
- C. With respect to a deed, in the event of breach of any of the above Non-discrimination covenants, the **Maine Department of Transportation** will have the right to enter or re-enter the lands and facilities thereon, and the above described lands and facilities will there upon revert to and vest in and become the absolute property of the **Maine Department of Transportation** and its assigns.*

(*Reverter clause and related language to be used only when it is determined that such a clause is necessary to make clear the purpose of Title VI.)

APPENDIX D

CLAUSES FOR CONSTRUCTION/USE/ACCESS TO REAL PROPERTY ACQUIRED UNDER THE ACTIVITY, FACILITY OR PROGRAM

The following clauses will be included in deeds, licenses, permits, or similar instruments/agreements entered into by the **Maine Department of Transportation** pursuant to the provisions of Assurance 7(b):

- A. The (grantee, licensee, permittee, etc., as appropriate) for himself/herself, his/her heirs, personal representatives, successors in interest, and assigns, as a part of the consideration hereof, does hereby covenant and agree (in the case of deeds and leases add, "as a covenant running with the land") that (1) no person on the ground of race, color, or national origin, will be excluded from participation in, denied the benefits of, or be otherwise subjected to discrimination in the use of said facilities, (2) that in the construction of any improvements on, over, or under such land, and the furnishing of services thereon, no person on the ground of race, color, or national origin, will be excluded from participation in, denied the benefits of, or otherwise be subjected to discrimination, (3) that the (grantee, licensee, lessee, permittee, etc.) will use the premises in compliance with all other requirements imposed by or pursuant to the Acts and Regulations, as amended, set forth in this Assurance.
- B. With respect to (licenses, leases, permits, etc.), in the event of breach of any of the above Non-discrimination covenants, the **Maine Department of Transportation** will have the right to terminate the (license, permit, etc., as appropriate) and to enter or re-enter and repossess said land and the facilities thereon, and hold the same as if said (license, permit, etc., as appropriate) had never been made or issued.*
- C. With respect to deeds, in the event of breach of any of the above Non-discrimination covenants, the **Maine Department of Transportation** will there upon revert to and vest in and become the absolute property of the **Maine Department of Transportation** and its assigns.*

(*Reverter clause and related language to be used only when it is determined that such a clause is necessary to make clear the purpose of Title VI.)

APPENDIX E

During the performance of this contract, the contractor, for itself, its assignees, and successors in interest (hereinafter referred to as the "contractor") agrees to comply with the following non-discrimination statutes and authorities; including but not limited to:

Pertinent Non-Discrimination Authorities:

- Title VI of the Civil Rights Act of 1964 (42 U.S.C. § 2000d et seq., 78 stat. 252), (prohibits discrimination on the basis of race, color, national origin); and 49 CFR Part 21.
- The Uniform Relocation Assistance and Real Property Acquisition Policies Act of 1970, (42 U.S.C. § 4601), (prohibits unfair treatment of persons displaced or whose property has been acquired because of Federal or Federal-aid programs and projects);
- Federal-Aid Highway Act of 1973, (23 U.S.C. § 324 et seq.), (prohibits discrimination on the basis of sex);
- Section 504 of the Rehabilitation Act of 1973, (29 U.S.C. § 794 et seq.), as amended, (prohibits discrimination on the basis of disability); and 49 CFR Part 27;
- The Age Discrimination Act of 1975, as amended, (42 U.S.C. § 6101 et seq.), (prohibits discrimination on the basis of age);
- Airport and Airway Improvement Act of 1982, (49 USC § 471, Section 47123), as amended, (prohibits discrimination based on race, creed, color, national origin, or sex);
- The Civil Rights Restoration Act of 1987, (PL 100-209), (Broadened the scope, coverage and applicability of Title VI of the Civil Rights Act of 1964, The Age Discrimination Act of 1975 and Section 504 of the Rehabilitation Act of 1973, by expanding the definition of the terms "programs or activities" to include all of the programs or activities of the Federal-aid recipients, sub-recipients and contractors, whether such programs or activities are Federally funded or not);
- Titles II and III of the Americans with Disabilities Act, which prohibit discrimination on the basis of disability in the operation of public entities, public and private transportation systems, places of public accommodation, and certain testing entities (42 U.S.C. §§ 12131-12189) as implemented by Department of Transportation regulations at 49 C.F.R. parts 37 and 38;
- The Federal Aviation Administration's Non-discrimination statute (49 U.S.C. § 47123) (prohibits discrimination on the basis of race, color, national origin, and sex);
- Executive Order 12898, Federal Actions to Address Environmental Justice in Minority Populations and Low-Income Populations, which ensures Non-discrimination against minority populations by discouraging programs, policies, and activities with disproportionately high and adverse human health or environmental effects on minority and low-income populations;
- Executive Order 13166, Improving Access to Services for Persons with Limited English Proficiency, and resulting agency guidance, national origin discrimination includes discrimination because of Limited English proficiency (LEP). To ensure compliance with Title VI, you must take reasonable steps to ensure that LEP persons have meaningful access to your programs (70 Fed. Reg. at 74087 to 74100);
- Title IX of the Education Amendments of 1972, as amended, which prohibits you from discriminating because of sex in education programs or activities (20 U.S.C. 1681 et seq.).

**DEPARTMENT OF THE ARMY
GENERAL PERMITS FOR
THE STATE OF MAINE**

The New England District of the U.S. Army Corps of Engineers (Corps) hereby issues 23 General Permits (GPs), listed below, for activities subject to Corps jurisdiction in waters of the United States within the boundaries of the State of Maine including tribal lands, and in adjacent ocean waters to the seaward limit of the outer continental shelf. These GPs are issued in accordance with Corps regulations at 33 CFR 320 – 332 and specifically 33 CFR 325.2(e)(2). These GPs will protect the aquatic environment and the public interest while effectively authorizing activities that have no more than minimal individual and cumulative adverse environmental effects.

This document contains the following sections:		Pages
I.	CORPS JURISDICTION	1
II.	GENERAL CRITERIA	2
III.	PROCEDURES	3 – 4
IV.	GENERAL CONDITIONS	5 – 19
V.	MAINE GENERAL PERMITS	20 – 35
VI.	SELF-VERIFICATION NOTIFICATION FORM	36
VII.	CONTENT OF A PRE-CONSTRUCTION NOTIFICATION	37 – 42
VIII.	AGENCY CONTACTS	43 – 45
IX.	DEFINITIONS	46 – 51

I. CORPS JURISDICTION

1. Permits are required from the Corps for the following work:

- a. The construction of any structure in, over, or under any navigable water of the U.S. (see 33 CFR 328), the excavating or dredging from or depositing of material in such waters, or the accomplishment of any other work affecting the course, location, condition, or capacity of such waters. The Corps regulates these activities under Section 10 of the Rivers and Harbors Act of 1899 (see 33 CFR 322);
- b. The discharge of dredged or fill material and certain discharges associated with excavation into waters of the U.S. including wetlands. The Corps regulates these activities under Section 404 of the Clean Water Act (see 33 CFR 323); and
- c. The transportation of dredged material for the purpose of disposal in the ocean. The Corps regulates these activities under Section 103 of the Marine Protection, Research and Sanctuaries Act of 1972 (see 33 CFR 324).

2. Related laws: Section 408 of the Rivers and Harbors Act of 1899, Section 401 of the Clean Water Act, Section 402 of the Clean Water Act, Section 307(c) of the Coastal Zone Management Act of 1972, Section 106 of the National Historic Preservation Act of 1966, Section 7 of the Endangered Species Act, the Fish and Wildlife Coordination Act of 1956, the Magnuson-Stevens Fishery Conservation and Management Act, Section 302 of the Marine Protection, Research and Sanctuaries Act of 1972, and Section 7(a) of the Wild and Scenic Rivers Act.

II. GENERAL CRITERIA

1. In order for activities to qualify for these General Permits (GPs), they shall meet the GPs terms and eligibility criteria on pages 1-4, all applicable general conditions (GCs) in Section IV, and terms of the Maine General Permits in Section V. Any activity not specifically listed may still be eligible for authorization under these GPs; prospective permittees are advised to contact the Corps for specific eligibility determination.
2. Under these GPs, activities may qualify for the following:
 - **SELF-VERIFICATION (SV):** Notification to the Corps is required at least two weeks before work commences; the Corps will acknowledge receipt and GP eligibility of the SV activity in writing.
 - **PRE-CONSTRUCTION NOTIFICATION (PCN):** Notification to and written verification from the Corps is required. *No work under PCN may proceed until written verification from the Corps is received.*

The thresholds for activities eligible for SV and PCN are defined in the general conditions in Section IV and Maine General Permits in Section V.

3. Prospective permittees shall review:
 - a. Section I to determine if the activity requires Corps authorization.
 - b. Sections III , IV, and V to determine if the activity is eligible for authorization under these GPs, and specifically whether it is eligible for SV, or whether a PCN is required.
4. Prospective permittees are encouraged to contact the Corps with questions at any time (U.S. Army Corps of Engineers, Maine Project Office, 442 Civic Center Drive, Suite 350, Augusta, Maine 04330, ph. 207-623-8367). Pre-application meetings, whether arranged by the Corps or requested by a prospective permittee, are encouraged to facilitate the review of projects. Pre-application meetings and/or site visits help streamline the authorization process by alerting the prospective permittee to potentially time-consuming factors that are likely to arise during the evaluation of their project (e.g. avoidance, minimization and compensatory mitigation requirements, historic properties, endangered species, essential fish habitat, vernal pools, and dredging of contaminated sediments).
5. Permittees shall ensure compliance with all applicable GCs in Section IV and GPs in Section V. Non-compliance with these GPs and GCs may subject the permittee to criminal, civil, or administrative criminal penalties, and/or an ordered restoration, and/or the permit may be modified, suspended or revoked by the Corps.

III. PROCEDURES

1. State Approvals. Applicants are responsible for applying for and obtaining any required state or local approvals. Federal and state jurisdiction and review criteria may differ in some instances. State permits may be required for specific projects regardless of the GP category.

In order for authorizations under these GPs to be valid, when any of the following state approvals or statutorily-required reviews is also required, the approvals shall be obtained prior to the commencement of work in Corps jurisdiction:

- Maine Department of Environmental Protection (DEP): Natural Resources Protection Act (NRPA) permit, including permit-by-rule (PBR) and general permit authorizations; Site Location of Development Act permit; Maine Waterway Development and Conservation Act permit; and Maine Hazardous Waste, Septage, and Solid Waste Management Act license.
- Maine Department of Agriculture, Conservation and Forestry: Land Use Planning Commission (LUPC) permit.
- Maine Department of Marine Resources: Aquaculture Leases and Licenses.
- Maine Department of Agriculture, Conservation and Forestry, Bureau of Parks and Lands, Submerged Lands: Submerged Lands Lease.

2. How to Obtain/Apply for Corps Authorization.

a. **Self-Verification (SV):** Prospective permittees shall confirm that the activity meets all the applicable terms and conditions of SV. Consultation with the Corps and/or other relevant federal and state agencies may be necessary to ensure compliance with the applicable general conditions (GCs) and related federal laws such as the National Historic Preservation Act (GC 15), the Endangered Species Act (GC 16), the Magnuson-Stevens Fishery Conservation and Management Act (GC 17), and the Wild and Scenic Rivers Act (GC 13). Activities that are eligible for SV are authorized under these GPs provided the prospective permittee has:

- i. Confirmed that the activity meets all applicable terms and conditions of SV.
- ii. Provided notifications to the State Historic Preservation Officer (SHPO) (the SHPO in the State of Maine is the Maine Historic Preservation Commission, or MHPC) and all five federally-recognized tribes in the State of Maine (Tribal Historic Preservation Officers, or THPOs) listed in Section VIII before submitting the SV to the Corps in order to be reviewed for the presence of historic, archeological, architectural, or tribal resources in the action area that the activity may affect (see GC 15). Prospective permittees are not required to wait for a response to their notifications before submitting the SV to the Corps.
- iii. At least two weeks before work is to commence, submitted to the Corps a Self-Verification Notification Form (SVNF, page 36) with all of the following attachments: location map, project plans, and an Official Species List of federally threatened and endangered species that may occur in the activity's action area and the email address of the person who generated the list (see GC 16).

NOTE: A copy of a state permit application form may be an acceptable surrogate for the SVNF itself; however, the applicant shall not rely on the state permitting agency to provide the Corps a copy of their state permit application.

b. **Pre-Construction Notification (PCN):** Notification to, and written verification from the Corps is required. For activities that do not qualify for SV or where otherwise required by the terms and conditions of the GPs, the prospective permittee shall submit a PCN and obtain written verification from the Corps before starting work in Corps jurisdiction. The Corps will coordinate review of all PCN activities with other federal and state agencies, as appropriate. The Corps will attempt to issue written verification of the PCN within 60 days of receiving a complete application.

All prospective permittees for PCN activities shall follow the instructions on found on pages 37 – 42, and in particular:

- i. Submit directly to the Corps application form *ENG Form 4345* (pages 40 – 42), or the surrogate state permit application form as noted above.

- ii. Provide project information outlined on pages 37 – 42 (Content of a Pre-Construction Notification).
- iii. Submit an Official Species List of federally threatened and endangered species that may occur in the activity's action area and the email address of the person who generated the list (GC 16).
- iv. Provide notifications to the SHPO (MHPC) and all five THPOs in the State of Maine listed in Section VIII before submitting the PCN to the Corps in order to be reviewed for the presence of historic, archeological, architectural, or tribal resources in the action area that the activity may affect (see GC 15). The PCN shall include documentation that MHPC and all of the THPOs were notified (a copy of the prospective permittee's cover letter or emails to MHPC and the THPOs is acceptable). Prospective permittees are not required to wait for a response to their notifications before submitting a PCN to the Corps.

c. Individual Permit (IP): Projects that are not eligible for these GPs require an IP (33 CFR 325.5(b)) and prospective permittees shall submit an application directly to the Corps. These GPs do not affect the Corps IP review process or activities exempt from Corps regulation. For general information regarding IPs prospective permittees are encouraged to contact the Corps. ***In addition, the Corps retains discretionary authority on a case-by-case basis to elevate GP-eligible activities to an IP based on concerns for the aquatic environment or for any other factor of the public interest (33 CFR 320.4(a)). Whenever the Corps notifies a prospective permittee that an IP is required, no work in Corps jurisdiction may be conducted until the Corps issues the required authorization in writing indicating that the work may proceed.***

d. Emergency Situations: Contact the Corps immediately in the event of an emergency situation for information on the verification process. Emergency situations are limited to sudden, unexpected occurrences that could potentially result in an unacceptable hazard to life, a significant loss of property, or an immediate, unforeseen, and significant economic hardship if corrective action requiring a permit is not undertaken within a time period less than the normal time needed to process an application under standard procedures. Emergency work is subject to the same terms and conditions of these GPs as non-emergency work, and similarly, must qualify for authorization under these GPs; otherwise an IP is required. The Corps will work with all applicable agencies to expedite verification according to established procedures in emergency situations.

IV. GENERAL CONDITIONS

An activity is authorized under the General Permits (GPs) only if that activity and the permittee satisfy all of the applicable GPs terms and following general conditions (GCs):

1. Federal Jurisdiction.
2. Minimal Direct, Secondary and Cumulative Effects.
3. Other Permits.
4. Water Quality and Coastal Zone Management.
5. Fills Within 100-Year Floodplains.
6. Discretionary Authority.
7. Single and Complete Project.
8. Use of Multiple General Permits.
9. Mitigation (Avoidance, Minimization, and Compensatory Mitigation).
10. Corps Projects and Property.
11. Navigation.
12. National Lands.
13. Wild and Scenic Rivers.
14. St. John/St. Croix Rivers.
15. Historic Properties.
16. Federal Threatened and Endangered Species.
17. Essential Fish Habitat.
18. Aquatic Life Movements and Management of Water Flows.
19. Spawning, Breeding, and Migratory Areas.
20. Vernal Pools.
21. Restoration of Special Aquatic Sites (Including Wetland Areas).
22. Invasive and Other Unacceptable Species.
23. Soil Erosion, Sediment, and Turbidity Controls.
24. Time-of-Year Work Windows/Restrictions.
25. Pile Driving and Pile Removal in Navigable Waters.
26. Temporary Fill.
27. Heavy Equipment in Wetlands or Mudflats.
28. Bank and Shoreline Stabilization Including Living Shorelines.
29. Stream Work and Crossings, and Wetland Crossings.
30. Utility Line Installation and Removal.
31. Storage of Seasonal Structures.
32. Aquaculture.
33. Permit(s)/Authorization Letter On-Site.
34. Inspections.
35. Maintenance.
36. Federal Liability.
37. Property Rights.
38. Previously Authorized Activities.
39. Transfer of GP Verifications.
40. Modification, Suspension, and Revocation.
41. Special Conditions.
42. False or Incomplete Information.
43. Abandonment.
44. Enforcement Cases.
45. Duration of Authorization.

1. Federal Jurisdiction.

a. Applicability of these GPs shall be evaluated with reference to federal jurisdictional boundaries (e.g. mean high water mark, high tide line, ordinary high water mark, and wetland boundary). Activities shall be evaluated with reference to “waters of the U.S.” under the Clean Water Act (33 CFR 328) and “navigable waters of the U.S.” under Section 10 of the Rivers and Harbors Act of 1899 (33 CFR 329). Prospective permittees are responsible for ensuring that the boundaries used satisfy the federal criteria defined at 33 CFR 328 – 229. These sections prescribe the policy, practice and procedures to be used in determining the extent of the Corps jurisdiction. Note: Waters of the U.S. includes all waters pursuant to 33 CFR 328.3(a), and in adjacent wetlands as that term is defined in 33 CFR 328.3(c).

b. Permittees shall identify on project plans wetlands, other special aquatic sites (SAS) including vegetated shallows (or submerged aquatic vegetation, SAV) and mudflats, and other waters, such as lakes and ponds, and perennial and intermittent streams on the project site. Wetlands shall be delineated in accordance with the Corps of Engineers Wetlands Delineation Manual and the most recent regional supplement pertaining to the State of Maine. GP-eligible activities may utilize wetland determinations conducted by State of Maine staff in-lieu of a wetland delineation. For activities located in Essential Fish Habitat (GC 17), permittees shall also identify on project plans natural rocky habitats and shellfish areas in order to satisfy the Magnuson-Stevens Fishery Conservation and Management Act.

2. Minimal Direct, Secondary and Cumulative Effects. To be eligible and subsequently authorized by these GPs, an activity shall result in no more than minimal individual and cumulative effects on the aquatic environment as determined by the Corps in accordance with the criteria listed within these GPs and GCs. This may require project modifications involving avoidance, minimization, or compensatory mitigation for unavoidable impacts to ensure that the net adverse effects of an activity are no more than minimal.

3. Other Permits. Permittees shall obtain other Federal, State, or local authorizations as required by law. Permittees are responsible for applying for and obtaining all required State of Maine or local approvals including a Flood Hazard Development Permit issued by the town/city. Work that is not regulated by the State of Maine, but is subject to Corps jurisdiction, may still be eligible for authorization under these GPs.

4. Water Quality and Coastal Zone Management.

a. Permittees shall satisfy any conditions imposed by the State of Maine and EPA, where applicable, in their Clean Water Act Section 401 Water Quality Certification (WQC) for these GPs, or in any Individual Section 401 WQC. See Section VIII for state-specific contact info and to determine if any action is required to obtain a 401 WQC. The Corps may require additional water quality management measures to ensure that the authorized activity does not cause or contribute to a violation of water quality standards. All projects authorized by these GPs shall be designed, constructed and operated to minimize or eliminate the discharge of pollutants.

b. Permittees shall satisfy any additional conditions imposed by the State of Maine in their Coastal Zone Management (CZM) Act of 1972 consistency concurrences for these GPs, or in any Individual CZM consistency concurrences. The Corps may require additional measures to ensure that the authorized activity is consistent with state coastal zone management requirements.

5. Fills Within 100-Year Floodplains. The activity shall comply with applicable Federal Emergency Management Agency (FEMA) approved State of Maine or municipal floodplain management requirements. Permittees should contact FEMA and/or the State of Maine Floodplain Management Program regarding floodplain management requirements (see Section VIII for Federal and state-specific contact info).

6. Discretionary Authority. Notwithstanding compliance with the terms and conditions of these GPs, the Corps retains discretionary authority to require a PCN or IP review based on concerns for the aquatic environment or for any other factor of the public interest (see 33 CFR 320.4(a)). This authority is invoked on a case-by-case basis whenever the Corps determines that the potential consequences of the proposal warrant a higher level of review based on the concerns stated above. This authority may be invoked for projects that may contribute to cumulative environmental impacts that are more than minimal or if there is a special resource or concern associated with a particular project.

7. Single and Complete Project. The term “single and complete project” is defined at 33 CFR 330.2(i) as the total project proposed or accomplished by one owner/developer or partnership or other association of owners/developers. These GPs shall not be used for piecemeal work and shall be applied to single and complete projects and as such, the same GP shall not be used more than once for the same single and complete project.

a. For non-linear projects, a single and complete project shall have independent utility. Portions of a multi-phase project that depend upon other phases of the project do not have independent utility. Phases of a project that would be constructed even if the other phases were not built can be considered as separate single and complete projects with independent utility.

b. Unless the Corps determines the activity has independent utility, all components of a single project and/or all planned phases of a multi-phased project (e.g., subdivisions should include all work such as roads, utilities, and lot development) shall be treated together as constituting one single and complete project. If any component of a single and complete project requires a PCN, the entire single and complete project shall be reviewed under PCN.

c. For linear projects such as power lines or pipelines with multiple crossings, a “single and complete project” is all crossings of a single water of the U.S. (i.e. single waterbody) at a specific location. For linear projects crossing a single waterbody several times at separate and distant locations, each crossing is considered a single and complete project. However, individual channels in a braided stream or river, or individual arms of a large, irregularly-shaped wetland or lake, etc., are not separate waterbodies, and crossings of such features cannot be considered separately.

8. Use of Multiple General Permits. The use of more than one GP for a single and complete project is prohibited, except when the acreage loss of waters of the U.S. authorized by the GPs does not exceed the acreage limit of the GPs with the highest specified acreage limit. For example, if a road crossing over waters is constructed under GP 10, with an associated utility line crossing authorized by GP 9, if the maximum acreage loss of waters of the U.S. for the total project is ≥ 3 acres it shall be evaluated as an IP.

9. Mitigation (Avoidance, Minimization, and Compensatory Mitigation).

a. Activities shall be designed and constructed to avoid and minimize adverse effects, both temporary and permanent, to waters of the U.S. to the maximum extent practicable to ensure that adverse effects to the aquatic environment are no more than minimal.

b. Compensatory mitigation for unavoidable impacts to waters of the U.S., including direct, secondary and temporal loss, will generally be required for permanent impacts that exceed the SV limits (SV limits are detailed in Section V), and may be required for temporary impacts that exceed the SV limits, to offset unavoidable impacts which remain after all appropriate and practicable avoidance and minimization has been achieved and to ensure that the adverse effects to the aquatic environment are no more than minimal. Proactive restoration projects or temporary impact work with no secondary effects may generally be excluded from this requirement.

c. Mitigation proposals shall follow the guidelines found in the Compensatory Mitigation for Losses of Aquatic Resources; Final Rule April 10, 2008; 33 CFR 332 (which can be found at: www.nae.usace.army.mil/Missions/Regulatory/Mitigation under “Compensatory Mitigation for Losses of Aquatic Resources, 33 CFR 332 (Compensatory Mitigation Rule)”) and any other regulation. Permittees considering the use of a monetary payment *in-lieu* of permittee-responsible mitigation as compensation for unavoidable impacts to waters of the U.S. in the State of Maine may utilize the Maine Natural Resources Conservation Program (MNRCP). Information regarding this compensatory program can be found at: www.mnrpc.org For unavoidable jurisdictional impacts affecting federally-endangered Atlantic salmon and/or its critical habitat, permittees may be required to compensate for the impacts by utilizing the Maine Atlantic Salmon Restoration and Conservation Program. Information regarding this *in-lieu-fee* compensatory program can be found at: www.maine.gov/dmr/science-research/searun/programs/ilffacts.html

10. Corps Projects and Property.

a. Corps projects and property can be found at: www.nae.usace.army.mil/Missions/Civil-Works

b. In addition to any authorization under these GPs, prospective permittees shall contact the Corps Real Estate Division at (978) 318-8585 for work occurring on or potentially affecting Corps properties and/or Corps-controlled easements to initiate reviews and determine what real estate instruments are necessary to perform work. Permittees may not commence work on Corps properties and/or Corps-controlled easements until they

have received any required Corps real estate documents evidencing site-specific permission to work.

c. Any proposed temporary or permanent modification or use of a Federal project (including but not limited to a levee, dike, floodwall, channel, anchorage, breakwater, seawall, bulkhead, jetty, wharf, pier, or other work built or maintained but not necessarily owned by the United States), which may obstruct or impair the usefulness of the Federal project in any manner, is not eligible for SV and requires review and approval by the Corps pursuant to 33 USC 408 (Section 408).

d. A PCN is required for all work in, over, under, or within a distance of three times the authorized depth of a Corps Federal Navigation Project (FNP) and may require permission under Section 408.

e. Any structure or work that extends closer to the horizontal limits of any FNP than a distance of three times the project's authorized depth shall be subject to removal at the owner's expense prior to any future Corps dredging or the performance of periodic hydrographic surveys.

f. Where a Section 408 permission is applicable, written verification for the PCN will not be issued prior to the decision on the Section 408 permission request.

11. Navigation

a. There shall be no unreasonable interference with general navigation by the existence or use of the activity authorized herein, and no attempt shall be made by the permittee to prevent the full and free use by the public of all navigable waters at or adjacent to the activity authorized herein.

b. Work in, over, under, or within a distance of three times the authorized depth of an FNP shall specifically comply with GC 10.

c. Any safety lights and/or signals prescribed by the U.S. Coast Guard, State of Maine or municipality, through regulations or otherwise, shall be installed and maintained at the permittee's expense on authorized facilities in navigable waters of the U.S.

d. The permittee understands and agrees that, if future operations by the U.S. require the removal, relocation, or other alteration, of the structure or work herein authorized, or if, in the opinion of the Secretary of the Army or his authorized representative, said structure or work shall cause unreasonable obstruction to the free navigation of the navigable waters, the permittee will be required, upon due notice from the Corps, to remove, relocate, or alter the structural work or obstructions caused thereby, without expense to the U.S. No claim shall be made against the U.S. on account of any such removal or alteration.

12. National Lands. Activities that impinge upon the value of any National Lands or Federal Properties including but not limited to a National Wildlife Refuge, National Forest, or any area administered by the National Park Service, U.S. Fish and Wildlife Service or U.S. Forest Service are not eligible for SV and require PCN.

13. Wild and Scenic Rivers.

a. The following activities in designated rivers of the National Wild and Scenic River (NWSR) System, or in a river designated by Congress as a "study river" for possible inclusion in the system, require a PCN unless the National Park Service has determined in writing to the prospective permittee that the proposed work will not adversely affect the NWSR designation or study status:

- i. Activities that occur in NWSR segments, in and 0.25 miles up or downstream of NWSR segments, or in tributaries within 0.25 miles of NWSR segments.
- ii. Activities that occur in wetlands within 0.25 miles of NWSR segments.
- iii. Activities that have the potential to alter free-flowing characteristics in NWSR segments.

b. As of October 14, 2020, National Wild and Scenic Rivers and congressional study rivers in Maine include: the Allagash River beginning at Telos Dam continuing to Allagash checkpoint at Eliza Hole Rapids, approximately 3 miles upstream of the confluence with the St. John River (length = 92 92.5 miles); and 11.25 miles of the York River, in the State of Maine, from its headwaters at York Pond to the mouth of the river at York Harbor, plus tributaries (the York River is currently under study).

14. St. John/St. Croix Rivers. A PCN is required for any work within the Saint John and Saint Croix River basins that requires approval of the International Joint Commission. In addition, a PCN is required if any temporary or permanent use, obstruction or diversion of international boundary waters could affect the natural flow or levels of waters on the Canadian side of the line; or if any construction or maintenance of remedial works,

protective works, dams, or other obstructions in waters downstream from boundary waters could raise the natural level of water on the Canadian side of the boundary.

15. Historic Properties.

a. No undertaking shall cause effects (as defined at 33 CFR 325 Appendix C and 36 CFR 800) on properties listed on, determined to be eligible for listing on, or potentially eligible for listing on the National Register of Historic Places, including previously unknown historic properties within the permit area, unless the Corps or another federal action agency has satisfied the consultation requirements of Section 106 of the National Historic Preservation Act (NHPA). The majority of historic properties are not listed on the National Register of Historic Places and may require identification and evaluation by qualified historic preservation and/or archeological consultants in coordination with the Corps and the State Historic Preservation Officer (SHPO) (the SHPO in the State of Maine is the Maine Historic Preservation Commission, MHPC) and/or the five federally-recognized tribes in the State of Maine (Tribal Historic Preservation Officers, or THPOs). The MHPC, the THPOs, and the National Register of Historic Places can assist with locating information on:

- i. Previously identified historic properties; and
- ii. Areas with potential for the presence of historic resources, which may require identification and evaluation by qualified historic preservation and/or archeological consultants in consultation with the Corps and MHPC and/or the THPO(s).

b. For activities eligible for these GPs, permittees shall ensure that the activity will not cause effects as stated above in 15(a). In order to comply with this condition, both SV and PCN prospective permittees shall notify MHPC and all five THPOs for their identification of historic properties. MHPC and the THPOs will generally respond within 30 days of receiving the notification if they believe that the activity may have an adverse effect to historic properties. A PCN is required if an activity may have an adverse effect to historic properties. The PCN shall be submitted as soon as possible if a proposed activity may cause effects as stated above in 15(a) a to ensure that the Corps is aware of any potential effects of the proposed activity on any historic property to ensure all Section 106 requirements are met.

c. All PCNs shall:

- i. Show notification to MHPC and all five THPOs for their identification of historic properties;
- ii. State which historic properties may be affected by the proposed work or include a vicinity map indicating the location of the historic properties or the potential for the presence of historic properties; and
- iii. Include any available documentation from MHPC or the THPO(s) indicating that there are or are not historic properties affected.

d. The requirements to comply with Section 106 of the NHPA may be satisfied by a Programmatic Agreement (PA) or Programmatic Consultation (PC) with the Corps, New England District or another federal agency. New England District PAs and PCs are found at www.nae.usace.army.mil/Missions/Regulatory

e. If the permittee discovers any previously unknown historic, cultural or archeological remains and artifacts while accomplishing the activity authorized by these permits, the permittee shall immediately notify the district engineer of what was found, and avoid construction activities that may affect the remains and artifacts until the required coordination has been completed. The district engineer will initiate the Federal, Tribal and state coordination required to determine if the items or remains warrant a recovery effort or if the site is eligible for listing in the National Register of Historic Places.

f. Federal agencies should follow their own procedures for complying with the requirements of Section 106 of the NHPA. Federal permittees shall provide the Corps with the appropriate documentation to demonstrate compliance with those requirements.

g. Federal and non-federal applicants should coordinate with the Corps before conducting any onsite archeological work (reconnaissance, surveys, recovery, etc.) requested by MHPC or the THPOs, as the Corps will determine the Permit Area for the consideration of historic properties based on 33 CFR 325 Appendix C. This is to ensure that work done is in accordance with Corps requirements.

16. Federal Threatened and Endangered Species.

- a. No activity is authorized by these GPs which:
 - i. Is likely to directly or indirectly jeopardize the continued existence of a threatened or endangered species or a species proposed for such designation, as identified under the Federal Endangered Species Act (ESA), or which will directly or indirectly destroy or adversely modify the critical habitat or proposed critical habitat of such species;
 - ii. “May affect” a listed species or critical habitat, unless Section 7 consultation addressing the effects of the proposed activity has been completed;
 - iii. Is “likely to adversely affect” a listed species or critical habitat unless Section 7 consultation has been completed by the Corps or another lead action agency in coordination with the Corps under the provisions of a Programmatic Agreement (PA) or Programmatic Consultation (PC); or
 - iv. Violates the ESA.

b. All prospective permittees shall attach to their SVNF or PCN an Official Species List obtained from the U.S. Fish and Wildlife Service’s Information for Planning and Consultation (IPaC) found at: <https://ecos.fws.gov/ipac> and provide the email address of the person who generated the list.

c. For proposed activities in tidal waters, prospective permittees should also refer to the National Oceanic and Atmospheric Administration (NOAA) Fisheries’ Section 7 Mapper for federally-listed species found at: <https://noaa.maps.arcgis.com/apps/webappviewer/index.html>

d. A PCN is required if a threatened or endangered species, a species proposed for listing as threatened or endangered, or designated or proposed critical habitat (all hereinafter referred to as “listed species or habitat”), as identified under the ESA, may be affected by the proposed work. An activity may remain eligible for SV if the only listed species affected is the northern long-eared bat (*Myotis septentrionalis*), and only after Section 7 consultation has been completed by the Corps under the 4(d) Rule Streamlined Consultation.

e. Federal agencies shall follow their own procedures for complying with the requirements of the ESA while ensuring that the Corps and any other federal action agencies are included in the consultation process.

f. Non-federal representatives designated by the Corps to conduct informal consultation or prepare a biological assessment shall follow the requirements in the designation document(s) and the ESA. Non-federal representatives shall also provide the Corps with the appropriate documentation to demonstrate compliance with those requirements. The Corps will review the documentation and determine whether it is sufficient to address ESA compliance for the GP activity, or whether additional ESA consultation is necessary.

g. The requirements to comply with Section 7 of the ESA may be satisfied by a Programmatic Agreement (PA) or Programmatic Consultation (PC) with the Corps, New England District or another federal agency. New England District PAs and PCs are found at: www.nae.usace.army.mil/Missions/Regulatory

17. Essential Fish Habitat (EFH).

a. PCN activities in tidal waters and the following rivers and streams, including all tributaries to the extent that they are currently or were historically accessible for salmon migration, shall be reviewed for the potential to adversely affect EFH (activities meeting SV criteria have been determined to result in no more than minimal adverse effects to EFH and therefore need no additional review):

Androscoggin River	Aroostook River	Boyden River	Dennys River
Ducktrap River	East Machias River	Hobart Stream	Kennebec River
Machias River	Narraguagus River	Orland River	Passagassawaukeag River
Patten Stream	Penobscot River	Pleasant River	Presumpscot River
Saco River	Sheepscot River	St. Croix River	Tunk Stream
Union River			

b. Prospective permittees may be required to describe and identify potential adverse effects to EFH and should refer to the NOAA Fisheries’ EFH Mapper found at:

www.fisheries.noaa.gov/resource/map/essential-fish-habitat-mapper

c. The requirements to comply with the Magnuson-Stevens Fishery Conservation and Management Act may be satisfied by a Programmatic Agreement (PA) or Programmatic Consultation (PC) with the Corps, New England District or another federal agency. New England District PAs and PCs are found at:

www.nae.usace.army.mil/Missions/Regulatory

18. Aquatic Life Movements and Management of Water Flows.

a. No activity may substantially disrupt the necessary life cycle movements of those species of aquatic life indigenous to the waterbody, including those species that normally migrate through the area, unless the activity's primary purpose is to impound water. Unless otherwise stated, activities permanently impounding water in a stream require a PCN to ensure impacts to aquatic life species are avoided and minimized. All permanent and temporary crossings of waterbodies and wetlands shall be:

- i. Suitably spanned, bridged, culverted, or otherwise designed and constructed to maintain low flows to sustain the movement of those aquatic species; and
- ii. Properly aligned and constructed to prevent bank erosion or streambed scour both adjacent to and inside the crossing.

b. To avoid adverse impacts on aquatic organisms, the low flow channel/thalweg shall remain unobstructed during periods of low flow, except when it is necessary to perform the authorized work.

c. For work in tidal waters, in-stream controls (e.g. cofferdams) should be installed in such a way as to not obstruct fish passage.

d. To the maximum extent practicable, the preconstruction course, condition, capacity, and location of open waters must be maintained for each activity, including stream channelization, storm water management activities, and temporary and permanent road crossings, except as provided below. The activity must be constructed to withstand expected high flows. The activity shall not restrict or impede the passage of normal or high flows, unless the primary purpose of the activity is to impound water or manage high flows. The activity may alter the pre-construction course, condition, capacity, and location of open waters if it benefits the aquatic environment (e.g. stream restoration or relocation activities).

e. Activities that temporarily or permanently adversely impact upstream or downstream flood conditions require a PCN.

19. Spawning, Breeding, and Migratory Areas.

a. Jurisdictional activities in waters of the U.S. such as certain excavations, discharges of dredged or fill material, and/or suspended sediment producing activities that provide value as fish migratory areas, fish and shellfish spawning or nursery areas, or amphibian and migratory bird breeding areas, during spawning or breeding seasons shall be avoided and minimized to the maximum extent practicable.

b. Jurisdictional activities in waters of the U.S. that provide value as breeding areas for migratory birds must be avoided to the maximum extent practicable. The permittee is responsible for ensuring their action complies with the Migratory Bird Treaty Act and the Bald and Golden Eagle Protection Act. The permittee is responsible for contacting the U.S. Fish and Wildlife's Maine Field Office (see Section VIII for contact info) to determine applicable measures to reduce impacts to migratory birds or eagles, including whether "incidental take" permits are necessary and available under the Migratory Bird Treaty Act or Bald and Golden Eagle Protection Act for a particular activity.

20. Vernal Pools.

a. A PCN is required if a discharge of dredged or fill material is proposed within a vernal pool depression located within waters of the U.S.

b. GC 20(a) above does not apply to projects that are within a municipality that meets the provisions of a Corps-approved vernal pool Special Area Management Plan (SAMP) and are otherwise eligible for SV, and the applicant meets the requirements to utilize the vernal pool SAMP.

21. Restoration of Special Aquatic Sites (Including Wetland Areas).

a. In areas of authorized temporary disturbance, if trees are cut they shall be cut at or above ground level and not uprooted in order to prevent disruption to the wetland soil structure and to allow stump sprouts to revegetate the work area, unless otherwise authorized.

b. The introduction or spread of invasive plant species in disturbed areas shall be controlled. If construction mats are to be used in areas of invasive plant species, they shall be thoroughly cleaned before use.

c. Wetland areas where permanent disturbance is not authorized shall be restored to their original condition and elevation. Original condition means protection and/or removal of existing soil and vegetation, and replacement back to the original location such that the original soil layering and vegetation schemes are

approximately the same, unless otherwise authorized. Restoration shall typically commence no later than the completion of construction.

d. Upon completion of construction, all areas of authorized disturbed wetland area shall be stabilized with a wetland seed mix containing only plant species native to New England and shall not contain any species listed in the “Invasive and Other Unacceptable Plant Species” Appendix K in the “New England District Compensatory Mitigation Guidance” found at: www.nae.usace.army.mil/Missions/Regulatory/Mitigation

22. Invasive and Other Unacceptable Species.

a. The introduction or spread of invasive or other unacceptable plant or animal species on the project site or areas adjacent to the project site caused by the site work shall be avoided to the maximum extent practicable. For example, construction mats and equipment shall be thoroughly cleaned and free of vegetation and soil before and after use. The introduction or spread of invasive plant or animal species on the project site caused by the site work shall be controlled.

b. No cultivars, invasive or other unacceptable plant species may be used for any mitigation, bioengineering, vegetative bank stabilization or any other work authorized by these GPs. However, non-native species and cultivars may be used when it is appropriate and specified in a written verification, such as using *Secale cereale* (Annual Rye) to quickly stabilize a site. All PCNs shall justify the use of non-native species or cultivars.

c. For the purposes of these GPs, plant species that are considered invasive and unacceptable are provided in Appendix K “Invasive and Other Unacceptable Plant Species” of the most recent “New England District Compensatory Mitigation Guidance” and is found at: www.nae.usace.army.mil/Missions/Regulatory/Mitigation The June 2009 “U.S. Army Corps of Engineers Invasive Species Policy” provides policy, goals and objectives and is located at www.nae.usace.army.mil/Missions/Regulatory/Invasive-Species If an Invasive Species Control/Management Plan has been prepared it should be included with any SV or PCN.

23. Soil Erosion, Sediment, and Turbidity Controls.

a. Adequate sedimentation and erosion control management measures, practices and devices, such as phased construction, installation of sediment control barriers (i.e. silt fence, vegetated filter strips, geotextilesilt fences, erosion control mixes, hay bales or other devices) downhill of all exposed areas, retention of existing vegetated buffers, application of temporary mulching during construction, and permanent seeding and stabilization shall be installed and properly maintained to reduce erosion and retain sediment on-site during and after construction. They shall be capable of preventing erosion; of collecting sediment, suspended and floating materials; and of filtering fine sediment.

b. Temporary sediment control barriers shall be removed upon completion of work, but not until all disturbed areas are permanently stabilized. The sediment collected by these sediment barriers shall be removed and placed at an upland location and stabilized to prevent its later erosion into a waterway or wetland.

c. All exposed soil and other fills shall be permanently stabilized at the earliest practicable date.

24. Time-of-Year Work (TOY) Windows/Restrictions. In-water work shall be conducted during the following TOY work windows (work allowed) under SV and any in-water work proposed during the following TOY restrictions (no work) shall be reviewed under PCN (and shall contain written justification for deviation from the work allowed windows). The term “in-water work” does not include conditions where the work site is “in-the-dry” (e.g. intertidal areas exposed at low tide). The term also does not include work contained in a cofferdam so long as the cofferdam was installed and subsequently removed within the work allowed window.

	<u>TOY Restriction (no work)</u>	<u>TOY Work Window (work allowed)</u>
Non-tidal waters	Oct. 1 st to Jul. 14 th	Jul. 15 th to Sep. 30 th
Tidal waters	Apr. 10 th to Nov. 7 th	Nov. 8 th to Apr. 9 th

Alternate work windows proposed under PCN will generally be coordinated with the U.S. Fish and Wildlife Service, National Marine Fisheries Service, Maine Department of Inland Fisheries and Wildlife, and/or Maine Department of Marine Resources and resulting written verifications may include species-specific work allowed windows.

25. Pile Driving and Pile Removal in Navigable Waters.

- a. Derelict, degraded, or abandoned piles and sheet piles in the project area shall be removed in their entirety as practicable and properly disposed of in an upland location and not in wetlands. In areas of fine-grained substrates, piles/sheets shall be removed by direct, vibratory, or clamshell pull method in order to minimize potential turbidity and sedimentation impacts. If removal is not practicable, said piles/sheets shall be cut off or driven to a depth of at least one foot below substrate.
- b. Work involving pile installation and/or removal should adhere to one of the five methods below:
 - i. "In-the-dry", or
 - ii. In-water between Nov. 8th to Apr. 9th, or
 - iii. Drilled and pinned to ledge, or
 - iv. Vibratory hammers used to install any size and quantity of wood, concrete, or steel, or impact hammers limited to one hammer and <50 piles installed/day with the following: wood piles of any diameter, concrete piles ≤18-inches diameter, steel piles ≤12-inches diameter if: (1) the hammer is ≤3,000 pounds and a wood cushion or equivalent is used between the hammer and steel pile, or (2) a soft start is used. Soft starts require an initial set of three strikes from the impact hammer at 40% energy, followed by a 1-minute waiting period between subsequent three-strike sets. The soft-start procedure shall be conducted any time hammering ceases for more than 30 minutes.

26. Temporary Fill.

- a. Temporary fills, including but not limited to construction mats and corduroy roads shall be entirely removed as soon as they are no longer needed to construct the authorized work. Temporary fill shall be placed in its original location or disposed of at an upland site and suitably contained to prevent its subsequent erosion into waters of the U.S.
- b. All temporary fill and disturbed soils shall be stabilized to prevent its eroding into waters of the U.S. where it is not authorized. Work shall include phased or staged development to ensure only areas under active development are exposed and to allow for stabilization practices as soon as practicable. Temporary fill shall be placed in a manner that will prevent it from being eroded by expected high flows.
- c. Unconfined temporary fill authorized for discharge into waters of the U.S. shall consist of material that minimizes impacts to water quality (e.g. washed stone, stone, etc.).
- d. Appropriate measures shall be taken to maintain normal downstream flows and minimize flooding to the maximum extent practicable when temporary structures, work, and discharges of dredged or fill material, including cofferdams, are necessary for construction activities, access fills, or dewatering of construction sites. Materials shall be placed in a location and manner that does not adversely impact surface or subsurface water flow into or out of the wetland. Temporary fill authorized for discharge into wetlands shall be placed on geotextile fabric or other appropriate material laid on the pre-construction wetland grade where practicable to minimize impacts and to facilitate restoration to the original grade. Construction mats are excluded from this requirement.
- e. Construction debris and/or deteriorated materials shall not be placed or otherwise located in waters of the U.S.

27. Heavy Equipment in Wetlands or Mudflats. Operating heavy equipment (drill rigs, fixed cranes, etc.) within wetlands shall be minimized, and to the maximum extent practicable such equipment shall not be stored, maintained or repaired in wetlands. Where construction requires heavy equipment operation in wetlands, the equipment shall: a) have low ground pressure (typically <3 psi); b) be placed on swamp/construction/timber mats (herein referred to as "mats") that are adequate to support the equipment in such a way as to minimize disturbance of wetland soil and vegetation; or c) be operated on adequately dry or frozen wetlands such that shear pressure does not cause subsidence of the wetlands immediately beneath equipment and upheaval of adjacent wetlands. Mats are to be placed in the wetland from the upland or from equipment positioned on mats if already working within a wetland. Other support structures that are capable of safely supporting equipment may be used with written Corps authorization. Similarly, the permittee may request written authorization from the Corps to waive use of mats during frozen or dry conditions. Construction mats should be managed in accordance with construction mat best management practices (BMPs) found at: www.nae.usace.army.mil/Missions/Regulatory/State-General-Permits/Maine-General-Permit

28. Bank and Shoreline Stabilization Including Living Shorelines.

a. Projects involving construction of or repair, replacement, and maintenance of bank or shoreline stabilization structures including living shorelines within Corps jurisdiction shall be designed to minimize environmental effects, effects to neighboring properties, scour, etc. to the maximum extent practicable.

b. Prospective permittees shall design and construct these stabilization projects using this sequential avoidance and minimization process: avoidance of aquatic resource impacts, diversion of overland flow, vegetative stabilization, living shorelines, stone-sloped surfaces, and walls/bulkheads. New vertical walls/bulkheads shall only be used in situations where reflected wave energy can be tolerated. Prospective permittees proposing new vertical walls/bulkheads shall provide written justification demonstrating why other methods of stabilization are not practicable and how the surrounding area would be affected by the resulting reflected wave energy.

Additional conditions to meet SV eligibility criteria for *non-tidal* bank and shoreline stabilization activities:

- a. Fill shall be ≤ 500 linear feet in total length as measured below the plane of the ordinary high watermark (OHWM), includes total if more than one stream bank.
- b. Fill placed below the plane of the OHWM shall be ≤ 1 cubic yard per linear foot.
- c. Fill shall not be angled steeper than 1H:1V.
- d. No discharge of fill in special aquatic sites other than wetlands.
- e. Stone revetment shall be comprised of angular material.
- f. No material shall be of the type, or placed in any location, or in any manner, to impair surface water flow into or out of any water of the U.S.
- g. No material shall be placed in a manner that will be eroded by normal or expected high flows (properly anchored trees and treetops may be used in low energy areas).
- h. The activity shall not be a stream channelization activity.

Additional conditions to meet SV eligibility criteria for *tidal* bank and shoreline stabilization activities:

- a. All in-water work shall be conducted "in-the-dry".
- b. Fill shall be ≤ 500 linear feet in total length as measured below the plane of the high tide line (HTL) and shall be ≤ 200 linear feet in total length as measured below the plane of the mean high water mark (MHW), includes total for more than one bank. Vertical structures shall be ≤ 200 linear feet in total length as measured below the plane of the MHW and shall be ≤ 18 inches waterward of the existing vertical face.
- c. Fill placed below the plane of the HTL shall be ≤ 1 cubic yard per linear foot.
- d. Stone revetment shall be comprised of angular material.
- e. Shall not impact special aquatic sites (SAS, incl. submerged aquatic vegetation, SAV), impacts to natural rocky habitats are ≤ 100 square feet, and impacts to intertidal and shellfish areas are $\leq 1,000$ square feet).
- f. No structures/fill shall be steeper than 1H:1V.
- g. No new groins, breakwaters, or jetties.

29. Stream Work and Crossings, and Wetland Crossings.

a. A PCN is required for all new and replacement crossings in navigable waters.

b. In order to effectively size and configure crossings in navigable waters, new and replacement crossings shall consider factors including but not limited to: local tidal elevations over the range of tidal heights, basin topography and bathymetry, existing and proposed road elevations. Flood risk tolerance, conditions of habitat and natural community types present, and sea level rise during the useful life of the crossing.

c. A PCN is required for activities that result in unavoidable impacts to wetlands in excess of SV thresholds.

d. In-stream work and crossings and wetland crossings shall adhere to all applicable GCs including but not limited to:

- i. GC 16 (Federally Threatened and Endangered Species)
- ii. GC 17 (Essential Fish Habitat)
- iii. GC 18 (Aquatic Life Movements and Management of Water Flows)

- iv. GC 23 (Soil Erosion, Sediment and Turbidity Controls)
- v. GC 24 (Time-of-Year Work Windows/Restrictions)
- vi. GC 26 (Temporary Fill)
- vii. GC 28 (Bank Stabilization)
- e. Slip Lining. Work resulting in a decreased width, height, or diameter of an existing crossing (e.g. slip lining and invert lining) is discouraged and requires PCN. Written justification shall be provided for this activity.
- f. Culvert Extensions. A PCN is required for any extension to an existing culvert.
- g. Scour protection or armoring of the inlet and/or outlet of a crossing shall not disrupt normal flow patterns or substantially disrupt the necessary life cycle movements of those species of aquatic life indigenous to the waterbody, including those species that normally migrate through the area (see GC 18).
- h. The permittee shall maintain the work authorized herein in good condition and in conformance with the terms and general conditions of this permit to facilitate aquatic life passage as stated in GC 18. Culverts that develop “hanging” inlets or outlets, result in bed washout, or a stream that doesn’t match the characteristics of the substrate in the natural stream channel such as mobility, slope, stability confinement will require maintenance or repair to comply with this GC (this does not apply to temporary stream crossings).

Additional conditions to meet SV eligibility criteria for Stream Work and Crossings:

- a. Crossings shall be designed and constructed using the techniques and principles outlined in Stream Simulation, Stream Smart, Habitat Connectivity Design.
- b. Crossings shall be designed to be at least 1.2 times bankfull width. Any footings, abutments, and/or abutment armoring shall also be at least 1.2 times bankfull width.
- c. Crossings shall have a natural bottom substrate under or within the structure matching the characteristics of the substrate in the natural stream channel. Crossings shall be designed and constructed with appropriate streambed forms and streambed characteristics so that water depths and velocities are comparable to those found in the adjacent natural channel at a variety of flows.
- d. Crossings shall include a bank on both sides of the stream matching the horizontal profile of the existing stream and banks in order to allow terrestrial passage for wildlife and to prevent undermining of the footings as applicable.
- e. Closed bottom culverts shall be embedded at least 25 percent of the maximum height of the culvert.
- f. No unconfined fill or excavation in flowing waters is allowed. In-stream construction work shall be conducted “in-the-dry” under no-flow conditions or by using cofferdams, temporary flume pipes, culverts, etc. Downstream flows shall be maintained during in-stream construction. It is recommended that project plans include pertinent details for working in-the-dry and maintaining downstream flows.
- g. Conditions (a) thru (e) immediately above do not apply to temporary stream crossings; however, in addition to conditions (f) immediately above, temporary stream crossings shall adhere to the following:
 - i. Be placed on geotextile fabric or other material where practicable to ensure restoration to the original grade. Soil may not be used to construct or stabilize these structures and rock shall be large enough to allow for easy removal without disrupting the streambed.
 - ii. Be designed and maintained to withstand and pass high flows. Water height shall be no higher than the top of the culvert’s inlet. A minimum culvert diameter of two feet is required to pass debris. Culverts shall be aligned to prevent bank erosion or streambed scour.
 - iii. Be equipped with energy dissipating devices installed downstream if necessary to prevent scour.
 - iv. Be designed and maintained to prevent soil from entering the waterbody.
 - v. Be removed upon the completion of work. Impacts to the streambed or banks requires restoration to their original condition using the methods in (a) above.

PCN Conditions for Stream Work and Crossings:

- a. Crossings are recommended to meet the conditions for SV; written justification shall be provided for any deviation from SV conditions.
- b. Crossings shall be designed using the least intrusive and environmentally damaging method following this sequential minimization process: 1) spans with no stream impacts, 2) spans with stream impacts, and 3) embedded culverts with Stream Simulation, Stream Smart, or Habitat Connectivity.

Additional Conditions for Wetland Crossings:

a. New and replacement wetland crossings that are permanent shall be constructed in such a manner as to preserve hydraulic and ecological connectivity, at its present level, between the wetlands on either side of the road. Crossing structures commonly include but are not limited to spans and culverts. To meet this condition, spans or culverts should be placed at least every 50 feet with an opening at least 2 feet high and 3 feet wide at ground level. Closed bottom culverts should be embedded at least 6 inches and should have a natural bottom substrate within the structure. Alternative crossing designs that preserve wetland hydraulic and ecological connectivity (e.g. “rock sandwiches”) may also be considered.

b. Any work that results in flooding, or impacts to wetland drainage from the upgradient side of the wetland crossing does not qualify for SV.

c. In the case of non-compliance, the permittee shall take necessary measures to correct wetland damage due to lack of hydraulic and ecological connectivity.

30. Utility Line Installation and Removal.

a. Utility lines in jurisdictional waters should be installed subsurface and shall be maintained in such a way so that they remain subsurface. If it is necessary to discharge dredged or filled material to keep such utility lines buried or restore them to their original subsurface condition, a PCN and written verification from the Corps may be required (e.g., in the case of side casting into wetlands from utility trenches).

b. For subsurface utility lines the bottom and side slope cover associated with the initial installation under Federal Navigation Projects (FNPs) is a technical determination. The depth requirement varies based on geotechnical (composition of bottom materials and layering), hydraulic (current, or wave induced scour depth), navigation (propeller induced scour depth and ships’ anchor penetration), maintenance dredging (penetration of barge spuds), construction factors (energy from blasting potentially transmitted to utility crossings), physical conditions (exposed open water conditions or sheltered/harbor conditions), and the proposed location of the utility crossing within any FNP or within navigable waters, including areas dredged by others. On a case-by-case basis, the Corps will determine the depth and cover requirements for each proposed utility crossing. Additional conditions to the GP will be attached to address pre and post installation requirements. In waterways that do not have existing FNPs, this depth should be taken as two feet below the existing bottom or maximum depth of proposed dredging, as applicable.

c. Aerial utility lines crossing navigable waters require PCN and shall meet minimum clearances per 33 CFR 322.5(i).

d. For horizontal directional drilling work, returns of drilling fluids to the surface (i.e., frac-outs) are not authorized and require restoration to the maximum extent practicable in accordance with the terms and conditions of these GPs. The permittee and its contractor shall have onsite and shall implement the procedures detailed in a frac-out contingency plan for monitoring drilling operations and for the immediate containment, control and recovery/removal of drilling fluids released into the environment should a discharge of material occur during drilling operations.

e. For new installations within waters of the U.S., any abandoned or inactive utility lines should be removed and faulty lines (e.g., leaking hazardous substances, petroleum products, etc.) shall be removed or repaired to the extent practicable. A PCN is required if they are to remain in place, e.g., to protect sensitive areas or ensure safety.

f. No work shall drain a water of the U.S. by providing a conduit for water on or below the surface. Trench plugs installed along pipelines may be effective.

g. Trenches should be backfilled with native sediment immediately after completion of work.

h. Pre-construction elevations should be re-established. Any additional material needed to accomplish this should be of consistent type and grain-size as the existing substrate sediment.

i. Utility line activities in non-tidal waters adjacent to special aquatic sites, and all work in tidal waters should utilize horizontal directional drilling as practicable.

31. Storage of Seasonal Structures. Seasonal or recreational structures such as pier sections, floats, aquaculture structures, etc. that are removed from the waterway for a portion of the year shall be stored in an upland location and not in wetlands, tidal wetlands, their substrate, or on mudflats. These seasonal structures may be stored on the fixed, pile-supported portion of a structure that is waterward of the mean high water mark or the ordinary high water mark, e.g. the storage of a ramp or gangway on the pile-supported pier. Seasonal storage of structures in navigable waters, e.g., in a protected cove, requires prior Corps approval and local harbormaster approval.

32. Aquaculture. Activities involving the cultivation of Atlantic salmon and other salmonids, or other federally-listed threatened or endangered species are not eligible for authorization under these GPs. All other aquaculture activities shall adhere to all applicable GCs including but not limited to:

- a. GC 3 (Other Permits) In particular, permittees shall maintain a current State of Maine Department of Marine Resources lease or license.
- b. GC 10 (Corps Projects and Property)
- c. GC 11 (Navigation)
- d. GC 16 (Federal Threatened and Endangered Species)
- e. GC 17 (Essential Fish Habitat)
- f. GC 18 (Aquatic Life Movements and Management of Water Flows)
- g. GC 31 (Storage of Seasonal Structures)

Additional conditions to meet SV eligibility criteria for Tidal Aquaculture:

- a. Shall not exceed 400 square feet in area.
- b. Shall receive signed approval from Harbormaster or appropriate Town Official.
- c. Shall not include enclosures or impoundments.
- d. Shall not be located in or within a distance of three times the authorized depth of a FNP.
- e. Shall not be located in or impinge upon the value of National Lands and Federal Properties including but not limited to National Parks and National Wildlife Refuges.
- f. Shall not impact special aquatic sites (SAS, incl. submerged aquatic vegetation, SAV), impacts to natural rocky habitats are ≤ 100 square feet, and impacts to intertidal and shellfish areas are $\leq 1,000$ square feet.
- g. No structures, cages, gear, or shell hash shall be located in/within 25 feet of SAV.
- h. All gear, except for mooring tackle, when not in use on the site shall be stored in an upland location above the mean high water mark and not on wetland (incl. salt marsh).

33. Permit(s)/Authorization Letter On-Site. The permittee shall ensure that a copy of the terms and conditions of these GPs and any accompanying authorization letter with attached plans are at the site of the work authorized by these GPs whenever work is being performed and that all construction personnel performing work which may affect waters of the U.S. are fully aware of the accompanying terms and conditions. The entire permit authorization shall be made a part of any and all contracts and subcontracts for work that affects areas of Corps jurisdiction at the site of the work authorized by these GPs. This shall be achieved by including the entire permit authorization in the specifications for work. The term "entire permit authorization" means all terms and conditions of the GPs, the GPs, and the authorization letter (including its drawings, plans, appendices and other attachments) and subsequent permit modifications as applicable. If the authorization letter is issued after the construction specifications, but before receipt of bids or quotes, the entire permit authorization shall be included as an addendum to the specifications. If the authorization letter is issued after receipt of bids or quotes, the entire permit authorization shall be included in the contract or subcontract. Although the permittee may assign various aspects of the work to different contractors or subcontractors, all contractors and subcontractors shall be obligated by contract to comply with all environmental protection provisions contained within the entire GP authorization, and no contract or subcontract shall require or allow unauthorized work in areas of Corps jurisdiction.

34. Inspections. The permittee shall allow the Corps to make periodic inspections at any time deemed necessary in order to ensure that the work is eligible for authorization under these GPs, is being, or has been performed in accordance with the terms and conditions of these GPs. To facilitate these inspections, the permittee shall

complete and return to the Corps the Work-Start Notification Form and the Compliance Certification Form when either is provided with an authorization letter. The Corps may also require post-construction engineering drawings and/or photographs for completed work or post-dredging survey drawings for any dredging work to verify compliance.

35. Maintenance. The permittee shall maintain the activity authorized by these GPs in good condition and in conformance with the terms and condition of these permits. This does not include maintenance dredging, related disposal, or beach nourishment projects, which are subject to review thresholds for GP 5 on page 30, unless specified in written authorization from the Corps.

36. Federal Liability. In issuing these permits, the Federal Government does not assume any liability for the following:

- a. Damages to the permitted project or uses thereof as a result of other permitted or unpermitted activities or from natural causes;
- b. Damages to the permitted project or uses thereof as a result of current or future activities undertaken by or on behalf of the U.S. in the public interest;
- c. Damages to persons, property, or to other permitted or unpermitted activities or structures caused by the activity authorized by this permit;
- d. Design or construction deficiencies associated with the permitted work; or
- e. Damage claims associated with any future modification, suspension, or revocation of this permit.

37. Property Rights. Per 33 CFR 320.4(g)(6), these GPs do not convey any property rights, either in real estate or material, or any exclusive privileges, nor does it authorize any injury to property or invasion of rights or any infringement of federal, state, or local laws or regulations.

38. Previously Authorized Activities.

- a. Projects that received prior authorization from the Corps (via Category 1 or 2) and that completed authorized work under the previous nationwide permits, programmatic permits, regional general permits or letters of permission, shall remain authorized in accordance with the original terms and conditions of those authorizations, including their terms, general conditions, expiration date, and any special conditions provided in a written verification.
- b. Activities authorized pursuant to 33 CFR Part 330.3 (“Activities occurring before certain dates”) are not affected by these GPs.
- c. Any work not commenced, not under contract to commence, nor completed that was originally authorized by the Corps under the GP in effect between October 13, 2015 and October 13, 2020 remains authorized subject to the terms and general conditions of this GP along with any special conditions included in written authorizations. Exception: if previously authorized work has not commenced or not under contract to commence and a new federally-listed threatened or endangered species may be affected, the Corps shall consult with the U.S. Fish and Wildlife Service or NOAA Fisheries prior to re-authorizing the work under these GPs. Requests for re-authorization shall include an Official Species List per GC 16.

39. Transfer of GP Verifications. If the permittee sells the property associated with a GP verification, the permittee may transfer the GP verification to the new owner by submitting a letter to the Corps to validate the transfer. A copy of the GP verification shall be attached to the letter, the letter shall contain the name, address, phone number and email of the transferee (new owner), shall include the following statement and signature, and be mailed to: U.S. Army Corps of Engineers, Maine Project Office, 442 Civic Center Drive, Suite 350, Augusta, Maine 04330:

“When the structures or work authorized by these GPs are still in existence at the time the property is transferred, the terms and conditions of these GPs, including any special conditions, will continue to be binding on the new owner(s) of the property.”

Transferee Printed Name

Transferee Signature Date

40. Modification, Suspension, and Revocation. These GPs and any individual authorization issued thereof may be either modified, suspended, or revoked, in whole or in part, pursuant to the policies and procedures of 33 CFR 325.7, and any such action shall not be the basis for any claim for damages against the U.S.

41. Special Conditions. The Corps may independently or in coordination with federal resource agencies impose special conditions on a project authorized pursuant to these GPs that are determined necessary to minimize adverse navigational and/or environmental effects, or based on any other factor of the public interest. Failure to comply with all terms and conditions of the authorization, including special conditions, constitutes a permit violation and may subject the permittee to criminal, civil or administrative penalties and/or an ordered restoration.

42. False or Incomplete Information. If the Corps makes a determination regarding the eligibility of a project under these GPs and subsequently discovers that it has relied on false, incomplete or inaccurate information provided by the permittee, the Corps may determine that the GP authorization is not valid; modify, suspend or revoke the authorization; and the U.S. Government may institute legal proceedings.

43. Abandonment. If the permittee decides to abandon the activity authorized under these GPs, unless such abandonment is merely the transfer of property to a third party, he/she may be required to restore the area to the satisfaction of the Corps.

44. Enforcement cases. These GPs do not apply to any existing or proposed activity in Corps jurisdiction associated with an ongoing Corps or EPA enforcement action, until such time as the enforcement action is resolved or the Corps or EPA, as appropriate, determines that the activity may proceed independently without compromising the enforcement action.

45. Duration of Authorization.

a. These GPs expire on October 14, 2025 unless otherwise specifically indicated in an individual authorization letter. Activities authorized under these GPs that have either commenced or are under contract to commence in reliance upon this authorization will have an additional year from the expiration date to complete the work. The permittee must be able to document to the Corps' satisfaction that the activity commenced or was under contract to commence by the expiration date of these GPs. If work is not completed within the one year extended timeframe, the permittee must contact the Corps. The Corps may issue a new authorization, provided the activity meets the applicable terms and conditions of the Maine GPs that are in effect at the time.

b. Activities authorized under these GPs will remain authorized until these GPs expire, unless discretionary authority has been exercised on a case-by-case basis to modify, suspend, or revoke the authorization in accordance with 33 CFR 325.2(e)(2). Activities completed under the SV or PCN authorizations of these GPs will continue to be authorized after its expiration date.

TURLEY.TAMMY. Digitally signed by
R.1229735124 TURLEY.TAMMY.R.1229735124
Date: 2020.10.13 10:09:04 -04'00'

Tammy R. Turley
Chief, Regulatory Division

V. MAINE GENERAL PERMITS

An activity is authorized under General Permits 1 through 23 listed below only if that activity and the permittee satisfy all of the applicable GP terms and general conditions. Any activity not specifically listed may still be eligible for authorization under these GPs; prospective permittees are advised to contact the Corps for specific eligibility determination.

1. **Repair, Replacement, and Maintenance of Authorized Structures and Fills;**

Repair, rehabilitation, or replacement of any previously authorized, currently serviceable structure, or fill and minor expansions thereof.

2. **Moorings**

New moorings and mooring fields, the relocation of previously authorized moorings, expansions, boundary reconfigurations or modifications of previously authorized mooring fields, conversion of mooring types (e.g. private to rental), and maintenance and replacement of moorings. Moored floats, lobster cars, rafts, and similar float structures are not included in this GP.

3. **Structures, Floats and Lifts**

New, expansions, reconfigurations or modifications of structures for navigational access in waters of the U.S. including but not limited to temporary/seasonal or permanent pile and crib-supported piers, floats, stairs, shore outhauls, and boat and float lifts/ways. Floats may include lobster cars, work floats, moored floats, swim floats, and shellfish upweller floats.

4. **Aids to Navigation, and Temporary Recreational Structures**

Aids to navigation and regulatory markers which are approved by and installed in accordance with the requirements of the U.S. Coast Guard (see 33 CFR, chapter I, subchapter C, part 66) and temporary buoys, markers, small floating docks, and similar structures placed for recreational use during specific events such as fireworks displays, water skiing competitions, and boat races or seasonal use.

5. **Dredging, Disposal of Dredged Material, Beach Nourishment, and Rock Removal and Relocation**

New, maintenance, and improvement dredging, including: a) Disposal of dredged material at a confined aquatic disposal, beach nourishment, near shore, designated open water or ocean water disposal site(s), provided the Corps finds the dredged material to be suitable for such disposal; (b) Beach nourishment not associated with dredging; (c) Rock removal and relocation for navigation.

6. **U.S. Coast Guard Approved Bridges and Causeways**

Discharges of dredged or fill material incidental to the construction and modification of bridges across navigable waters of the U.S., including cofferdams abutments, foundation seals, piers, approach fills, and temporary construction and access fills provided that the USCG authorizes the construction of the bridge structure under Section 9 of the Rivers and Harbors Act of 1899 or other applicable laws.

7. **Bank and Shoreline Stabilization Including Living Shorelines**

Bank stabilization activities necessary for erosion protection along the banks of lakes, ponds, streams, and marine/tidal waters. Includes bulkheads, seawalls, riprap, revetments or slope protection & similar structures as well as vegetative planting, soil bioengineering or alternative techniques that are a combination of the two (i.e. living shorelines), specifically for the purpose of shoreline protection.

8. **Residential, Commercial and Institutional Developments, and Recreational Facilities**

Discharges of dredged or fill material into waters of the U.S for the construction or expansion of: residences and residential subdivisions; commercial and institutional buildings or subdivisions; and recreational facilities; and attendant features including but not limited to roads, parking lots, garages, stormwater management facilities, yards, and utilities.

9. Utility Line Activities

Activities required for (a) the construction, maintenance, relocation, repair, & removal of utility lines, including outfall and intake structures, and the associated excavation, backfill, or bedding for utility lines; (b) the construction, maintenance or expansion of utility line substation facilities associated with a power/utility line in non-tidal waters; and (c) the construction and maintenance of foundations for overhead utility line towers, poles, and anchors provided the foundations are the minimum size necessary and separate footings for each tower leg (rather than a larger single pad) are used where feasible. This GP authorizes the construction of access roads to facilitate construction of the above activities provided the activity, in combination with all other activities included in one single and complete project.

10. Linear Transportation Projects

Activities required for the construction, expansion, modification, or improvement of linear transportation projects (e.g., driveways, roads, highways, railways, trails, airport runways, and taxiways) and attendant features.

11. Mining Activities

Temporary or permanent discharges of dredged or fill material into waters of the U.S. for mining activities.

12. Boat Ramps and Marine Railways

Temporary or permanent discharges of dredged or fill material, excavation and other work in waters of the U.S. required for the construction of temporary or permanent boat ramps and marine railways.

13. Land and Water-Based Renewable Energy Generation Facilities and Hydropower Projects

Structures and work and discharges of dredged or fill material into waters of the U.S. for the construction, expansion, modification or removal of: (a) land-based renewable energy production facilities (e.g. solar and wind) and their attendant features; (b) water-based wind or hydrokinetic renewable energy generation pilot projects and their attendant features; and (c) discharges of dredged or fill material associated with hydropower projects. Attendant features may include, but are not limited to, land-based collection and distribution facilities, control facilities, and parking lots.

14. Reshaping Existing Drainage Ditches and Mosquito Management

Discharges to modify the cross-sectional configuration of currently serviceable drainage ditches constructed in waters of the U.S., for the purpose of improving water quality by regrading the drainage ditch with gentler slopes, which can reduce erosion, increase growth of vegetation, and increase uptake of nutrients and other substances by vegetation. Also authorized are mosquito reduction activities.

15. Response Operations for Oil or Hazardous Substances

Activities conducted in response to a discharge or release of oil and hazardous substances that are subject to the National Oil and Hazardous Substances Pollution Contingency Plan (40 CFR 300) including containment, cleanup, and mitigation efforts, provided activities are done under either (i) The Spill Prevent, Control & Countermeasure Plan require by 40 CFR 112.3; (ii) The direction or oversight of the Federal on-site coordinator designated by 40 CFR 300; or (iii) Any approved existing State, regional or local contingency plan provided that the Regional Response Team (if one exists in the area) concurs with the proposed response efforts or does not object to the response effort. Activities required for the cleanup of oil releases in waters of the U.S. from electrical equipment that are governed by EPA's polychlorinated biphenyl (PCB) spill response regulations at 40 CFR 761. Booms placed in tidal waters. Use of temporary structures & fills for spill response training exercises.

16. Cleanup of Hazardous and Toxic Waste

Specific activities to effect the containment, stabilization or removal of hazardous or toxic waste materials, including court ordered remedial action plans or related settlements which are performed, ordered or sponsored by a government agency with established legal or regulatory authority.

17. Scientific Measurement Devices

Scientific devices for measuring and recording scientific data, such as staff gauges, tide and current gauges, meteorological stations, water recording and biological observation devices, water quality testing and improvement devices, and similar structures.

18. Survey Activities

Survey activities such as soil borings, core sampling, seismic exploratory operations, plugging of seismic shot holes and other exploratory-type bore holes, exploratory trenching and historic resources surveys (but not recovery).

19. Agricultural Activities

Regulated discharges of dredged or fill material in non-tidal waters of the U.S. for agricultural activities, including the construction of building pads for farm buildings. Authorized activities include: (a) installation, placement, or construction of drainage tiles, ditches, or levees; mechanized land clearing; land leveling; the relocation of existing serviceable drainage ditches; and similar activities; (b) construction of farm ponds, excluding perennial streams, provided the farm pond is used solely for agricultural purposes; and (c) discharges of dredged or fill material to relocate existing serviceable drainage ditches constructed in non-tidal streams.

20. Fish and Wildlife Harvesting, Enhancement, and Attraction Devices

Activities in waters of the U.S. associated with fish and wildlife harvesting devices including pound nets, crab and lobster traps, crab dredging, eel pots, duck blinds, and clam and oyster digging, fish aggregating devices, and small fish attraction devices such as open water fish concentrators (sea kites, etc.). This GP does not include aquaculture activities.

21. Habitat Restoration, Establishment and Enhancement Activities

Activities in waters of the U.S. associated with the restoration, enhancement and establishment of non-tidal and tidal wetlands and riparian areas, including invasive, non-native or nuisance species control; the restoration and enhancement of non-tidal streams and other non-tidal open waters; the relocation of non-tidal waters, including non-tidal streams & associated wetlands for reestablishment of a natural stream morphology and reconnection of the floodplain; the restoration and enhancement of shellfish, finfish and wildlife; and the rehabilitation or enhancement of tidal streams, tidal wetlands and tidal open waters; provided those activities result in net increases in aquatic resource functions and services. Also included are shellfish enhancement measures including but not limited to “brushing”, clam pots, boxes, and netting.

22. Stream and Wetland Work and Crossings

Activities required for the construction, expansion, modification, or improvement of linear transportation projects that cross waters of the U.S. (e.g., driveways, roads, highways, railways, trails, airport runways, and taxiways) and attendant features. Crossing structures include, but are not limited to temporary or permanent jurisdictional spans, bridges, culverts, and fords. Any stream channel modification is limited to the minimum necessary to construct or protect the project; such modifications must be in the immediate vicinity of the project.

23. Aquaculture

The installation of buoys, floats, racks, trays, nets, lines or other structures in waters of the U.S. for the containment and cultivation of fish, shellfish and seaweed/kelp. Also authorized are anchored upweller floats, small-scale shellfish hatchery seawater intake/discharge structures, and discharges of dredged or fill material associated with cultivation such as the placement of cultch or spatting-shell on bottom.

USER NOTE: All Self-Verification and Pre-Construction Notification activities shall comply with all applicable terms (pages 1 - 4), General Conditions (pages 5 - 19), and additional terms below.

GENERAL PERMITS FOR THE STATE OF MAINE

	<p>A. INLAND WATERS AND WETLANDS</p>	<p>Inland Waters and Wetlands are defined as waters that are regulated under Section 404 of the Clean Water Act, including rivers, streams, lakes, ponds, and wetlands, and <i>excludes Section 10 Navigable Waters of the U.S.</i> The jurisdictional boundaries are the ordinary high water mark (OHWM) in the absence of adjacent wetlands; beyond the OHWM to the limit of adjacent wetlands when adjacent wetlands are present; and the wetland limit when only wetlands are present. For the purposes of these GPs and designated activities, fill placed in the area between the mean high water mark (MHWM) and the high tide line (HTL), and in the bordering and contiguous wetlands to tidal waters are reviewed in the Navigable Waters section below beginning on page 28.</p> <p>Activities not meeting the Self-Verification terms below require Pre-Construction Notification and activities not meeting the Pre-Construction Notification terms below require an application for an Individual Permit (IP).</p>
	<p>GENERAL PERMIT #</p>	<p>SELF-VERIFICATION (SV)</p>
<p>1. Repair, Replacement, and Maintenance of Authorized Structures and Fills <i>(for stream crossings see GP 22)</i></p>	<p>Repair, replacement, and maintenance of existing, currently serviceable, authorized fills with no expansion or change in use, provided:</p> <ul style="list-style-type: none"> • Conditions of the original authorization apply. • Minor deviations in fill design allowed. • The repair, rehabilitation, or replacement of those structures or fills destroyed or damaged by storms, floods, fire or other discrete events is authorized, provided the work is commenced, or is under contract to commence, within two years of the date of their destruction or damage. • Drawdown of impoundments for dam/levee repair does not exceed 18 months and one growing season (Apr-Sept). 	<p>PRE-CONSTRUCTION NOTIFICATION (PCN)</p> <p>Repair, replacement, and maintenance of existing authorized fills not eligible for SV, provided:</p> <ul style="list-style-type: none"> • <3 acres of permanent and/or temporary inland waterway and/or wetland fill, and associated secondary impacts.
<p>2. Moorings</p>	<p>Not Applicable – these activities in non-navigable inland waters do not require Corps authorization.</p>	<p>Not Applicable – these activities in non-navigable inland waters do not require Corps authorization.</p>
<p>3. Structures, Floats, and Lifts</p>	<p>Pile-supported structures, floats and lifts located in non-navigable inland waters do not require Corps authorization.</p> <p>Solid fill or crib-supported structures with <15,000 SF of permanent and/or temporary inland waterway and/or wetland fill, and associated secondary impacts.</p>	<p>Fill activities associated with structures, floats, and lifts not eligible for SV, provided:</p> <ul style="list-style-type: none"> • <3 acres of permanent and/or temporary inland waterway and/or wetland fill, and associated secondary impacts.
<p>4. Aids to Navigation and Temporary Recreational Structures</p>	<p>Not Applicable – these activities in non-navigable inland waters do not require Corps authorization.</p>	<p>Not Applicable – these activities in non-navigable inland waters do not require Corps authorization.</p>
<p>5. Dredging, Disposal of Dredged Material, Beach Nourishment, and Rock Removal and Relocation</p>	<p>Those activities with <15,000 SF of permanent and/or temporary inland waterway and/or wetland fill, and associated secondary impacts, provided:</p> <ul style="list-style-type: none"> • No stream channelization, relocation, or loss of streambed including impoundments or discharges of tailings into streams. 	<p>Those activities not eligible for SV, provided:</p> <ul style="list-style-type: none"> • <3 acres of permanent and/or temporary inland waterway and/or wetland fill, and associated secondary impacts.

SELF-VERIFICATION (SV)

PRE-CONSTRUCTION NOTIFICATION (PCN)

<p>6. U.S. Coast Guard Approved Bridges and Causeways</p>	<p>Not applicable in inland waters and wetlands; see B. Navigable Waters on page 31 below.</p>	<p>Not applicable in inland waters and wetlands; see B. Navigable Waters on page 31 below.</p>
<p>7. Bank and Shoreline Stabilization Including Living Shorelines (see also GC 28)</p>	<p>Bank and shoreline stabilization activities with <15,000 SF of permanent and/or temporary inland waterway and/or wetland fill, and associated secondary impacts, provided:</p> <ul style="list-style-type: none"> • Fill is ≤500 LF in total length as measured below the plane of the OHWM, includes total if more than one stream bank. • Fill placed below the plane of the OHWM is ≤1 CY per linear foot. • There is no discharge in special aquatic sites other than wetlands. • Revetment is comprised of angular material. • In-stream work is limited to Jul. 15th to Sep. 30th • No structures angled steeper than IH:1V. 	<p>Bank and shoreline stabilization activities not eligible for SV, provided:</p> <ul style="list-style-type: none"> • <3 acres of permanent and/or temporary inland waterway and/or wetland fill, and associated secondary impacts.
<p>8. Residential, Commercial and Institutional Developments, and Recreational Facilities</p>	<p>Those developments and facilities with <15,000 SF of permanent and/or temporary inland waterway and/or wetland fill, and associated secondary impacts. Fill area includes all temporary and permanent fill, and regulated discharges associated with excavation. Provided:</p> <ul style="list-style-type: none"> • The historic fill and proposed fill area <15,000 SF specifically complies with GC 5 Single and Complete Projects. • No work in special aquatic sites other than wetlands. 	<p>Those developments and facilities not eligible for SV, provided:</p> <ul style="list-style-type: none"> • <3 acres of permanent and/or temporary inland waterway and/or wetland fill, and associated secondary impacts. <p><i>Mechanical clearing of areas within Corps jurisdiction without grubbing or other soil disturbance > 3 acres as a secondary impact may still be eligible for PCN at the discretion of the Corps.</i></p>
<p>9. Utility Line Activities (see also GC 30)</p>	<p>Utility line activities with <15,000 SF of permanent and/or temporary inland waterway and/or wetland fill (excluding mats), and associated secondary impacts, provided:</p> <ul style="list-style-type: none"> • There is no permanent change in pre-construction contours in waters in the U.S. • Material resulting from trench excavation is temporarily side cast into waters of the U.S. for <3 months and is placed in such a manner that is not dispersed by current or other forces. • The line does not run parallel to, or along a streambed. • No stream channelization, relocation, or loss of streambed including impoundments. • There is no discharge in special aquatic sites other than wetlands. • Construction mats of any area necessary to conduct activities provided mats are removed as soon as work is completed and shall be in place no longer than one single growing season. • In-stream work is limited to Jul. 15th to Sep. 30th • In-water work is conducted in-the-dry. • Intake structures that are dry hydrants used exclusively for firefighting activities with no stream impoundments. • Construction mats of any area necessary to conduct activities provided mats are removed as soon as work is completed and shall be in place no longer than one single growing season. 	<p>Utility line activities not eligible for SV, provided:</p> <ul style="list-style-type: none"> • <3 acres of permanent and/or temporary inland waterway and/or wetland fill, and associated secondary impacts. <p><i>Mechanical clearing of areas within Corps jurisdiction without grubbing or other soil disturbance > 3 acres as a secondary impact may still be eligible for PCN at the discretion of the Corps.</i></p>

SELF-VERIFICATION (SV)

PRE-CONSTRUCTION NOTIFICATION (PCN)

<p>10. Linear Transportation Projects <i>(for stream crossings refer to GP 22)</i></p>	<p>Linear transportation activities with <15,000 SF of permanent and/or temporary inland waterway and/or wetland fill (excl. mats), and associated secondary impacts, provided:</p> <ul style="list-style-type: none"> • The historic fill and proposed fill area <15,000 SF specifically complies with GC 5 Single and Complete Projects. • There is no discharge in special aquatic sites other than wetlands. • Construction mats of any area necessary to conduct activities provided mats are removed as soon as work is completed and shall be in place no longer than one single growing season. 	<p>Linear transportation activities not eligible for SV, provided:</p> <ul style="list-style-type: none"> • <3 acres of permanent and/or temporary inland waterway and/or wetland fill, and associated secondary impacts. <p><i>Mechanical clearing of areas within Corps jurisdiction without grubbing or other soil disturbance > 3 acres as a secondary impact may still be eligible for PCN at the discretion of the Corps.</i></p>
<p>11. Mining Activities</p>	<p>Mining activities with <15,000 SF of permanent and/or temporary inland waterway and/or wetland fill, and associated secondary impacts, provided:</p> <ul style="list-style-type: none"> • No stream channelization, relocation, or loss of streambed including impoundments. 	<p>Mining activities not eligible for SV, provided:</p> <ul style="list-style-type: none"> • <3 acres of permanent and/or temporary inland waterway and/or wetland fill, and associated secondary impacts.
<p>12. Boat Ramps</p>	<p>Boat ramps with <15,000 SF of permanent and/or temporary inland waterway and/or wetland fill, and associated secondary impacts, and temporary fills.</p>	<p>Boat ramps not eligible for SV, provided:</p> <ul style="list-style-type: none"> • <3 acres of permanent and/or temporary inland waterway and/or wetland fill, and associated secondary impacts.
<p>13. Land and Water-Based Renewable Energy Generation Facilities and Hydropower Projects</p>	<p>Those facilities and projects with <15,000 SF of permanent and/or temporary inland waterway and/or wetland fill, and associated secondary impacts, provided:</p> <ul style="list-style-type: none"> • No stream channelization, relocation, or loss of streambed including impoundments. • No new water-based facilities are eligible. 	<p>Those facilities and projects not eligible for SV, provided:</p> <ul style="list-style-type: none"> • <3 acres of permanent and/or temporary inland waterway and/or wetland fill, and associated secondary impacts. <p><i>Mechanical clearing of areas within Corps jurisdiction without grubbing or other soil disturbance > 3 acres as a secondary impact may still be eligible for PCN at the discretion of the Corps.</i></p>
<p>14. Reshaping Existing Ditches and Mosquito Management</p>	<p>Not applicable in inland waters and wetlands; see B. Navigable Waters on page 33 below.</p>	<p>Not applicable in inland waters and wetlands; see B. Navigable Waters on page 33 below.</p>
<p>15. Response Operations for Oil or Hazardous Substances</p>	<p>The SVNf or a surrogate state reporting form may be submitted after-the-fact for response operations.</p> <p>This GP also authorizes the use of temporary structures and fills in waters of the U.S. for spill response training exercises with <15,000 SF of permanent and/or temporary inland waterway and/or wetland fill, and associated secondary impacts (<i>SVNF is required prior to the activity</i>).</p>	<p>Those response operations not eligible for SV, provided:</p> <ul style="list-style-type: none"> • <3 acres of permanent and/or temporary inland waterway and/or wetland fill, and associated secondary impacts.

SELF-VERIFICATION (SV)

PRE-CONSTRUCTION NOTIFICATION (PCN)

<p>16. Cleanup of Hazardous and Toxic Waste</p>	<p>Those cleanup activities with <15,000 SF of permanent and/or temporary inland waterway and/or wetland fill, and associated secondary impacts, provided:</p> <ul style="list-style-type: none"> • No stream channelization, relocation, or loss of streambed including impoundments. • The activity does not involve establishing new disposal sites or expanding existing sites used for the disposal of hazardous or toxic waste. 	<p>Those cleanup activities not eligible for SV, provided:</p> <ul style="list-style-type: none"> • <3 acres of permanent and/or temporary inland waterway and/or wetland fill, and associated secondary impacts. • The activity does not involve establishing new sites for the disposal of hazardous or toxic waste.
<p>17. Scientific Measurements Devices</p>	<p>Those devices with <15,000 SF of permanent and/or temporary inland waterway and/or wetland fill, and associated secondary impacts, provided:</p> <ul style="list-style-type: none"> • No biological sampling devices. • Devices do not restrict or concentrate movement of aquatic organisms. • Upon completion of use, the devices and any associated fills shall be removed in their entirety. 	<p>Those devices not eligible for SV, provided:</p> <ul style="list-style-type: none"> • <3 acres of permanent and/or temporary inland waterway and/or wetland fill, and associated secondary impacts.
<p>18. Survey Activities</p>	<p>Those survey activities with <15,000 SF of permanent and/or temporary inland waterway and/or wetland fill, and associated secondary impacts, provided:</p> <ul style="list-style-type: none"> • Exploratory trenches are restored in accordance with GC 21. • No discharge of excavated material from test wells for oil and gas exploration (the plugging of such wells is authorized). 	<p>Those survey activities not eligible for SV, provided:</p> <ul style="list-style-type: none"> • <3 acres of permanent and/or temporary inland waterway and/or wetland fill, and associated secondary impacts.
<p>19. Agricultural Activities</p>	<p>Those agricultural activities subject to Corps jurisdiction with <15,000 SF of permanent and/or temporary inland waterway and/or wetland fill, and associated secondary impacts, provided:</p> <ul style="list-style-type: none"> • No stream channelization, relocation, or loss of streambed including impoundments. 	<p>Those agricultural activities subject to Corps jurisdiction not eligible for SV, provided:</p> <ul style="list-style-type: none"> • <3 acres of permanent and/or temporary inland waterway and/or wetland fill, and associated secondary impacts.
<p>20. Fish and Wildlife Harvesting, Enhancement and Attraction Devices and Activities</p>	<p>Not applicable in inland waters and wetlands; see B. Navigable Waters on page 34 below.</p>	<p>Not applicable in inland waters and wetlands; see B. Navigable Waters on page 34 below.</p>
<p>21. Habitat Restoration, Establishment, and Enhancement</p>	<p>Those activities with <15,000 SF of permanent and/or temporary inland waterway and/or wetland fill, and associated secondary impacts, provided:</p> <ul style="list-style-type: none"> • No water impoundments allowed. • No conversion of a stream to wetland or vice versa, a wetland to a pond or uplands, or one wetland type to another. • No dam removal. 	<p>Those activities not eligible for SV, provided:</p> <ul style="list-style-type: none"> • <3 acres of permanent and/or temporary inland waterway and/or wetland fill, and associated secondary impacts.

SELF-VERIFICATION (SV)

PRE-CONSTRUCTION NOTIFICATION (PCN)

<p>22. Stream and Wetland Work and Crossings (see also GC 29)</p>	<p>Stream work and crossings with <15,000 SF of permanent and/or temporary inland waterway and/or wetland fill, and associated secondary impacts, provided:</p> <ul style="list-style-type: none"> • No work in designated or proposed critical habitat for endangered species. • Crossings are designed and constructed using the techniques and principles outlined in Stream Simulation, Stream Smart, or Habitat Connectivity Design. • Crossings are designed to be 1.2 times bankfull width. • Crossings have a natural bottom substrate. • Crossings include a bank on both sides of the channel. • Closed bottom culverts are embedded at least 25% of the maximum width of the culvert. • In-stream work is limited to Jul. 15th to Sep. 30th • In-stream work is conducted “in-the-dry”. • No slip lining. • No culvert extensions. • No stream channelization, relocation, or loss of streambed including impoundments. <p>Wetland work and crossings, provided:</p> <ul style="list-style-type: none"> • No flooding or impacts to wetland drainage from the upgradient side of the crossing. 	<p>Stream and Wetland Work and Crossings not eligible for SV, provided:</p> <ul style="list-style-type: none"> • <3 acres of permanent and/or temporary inland waterway and/or wetland fill, and associated secondary impacts.
<p>23. Aquaculture (see also GC 32)</p>	<p>Aquaculture activities with <15,000 SF of permanent and/or temporary inland waterway and/or wetland fill, and associated secondary impacts, provided:</p> <ul style="list-style-type: none"> • No water impoundments allowed. • No conversion of i) a stream to wetland or vice versa, a wetland to a pond or uplands, and ii) one wetland type to another. 	<p>Aquaculture activities not eligible for SV, provided:</p> <ul style="list-style-type: none"> • <3 acres of permanent and/or temporary inland waterway and/or wetland fill, and associated secondary impacts.

USER NOTE: All Self-Verification and Pre-Construction Notification activities shall comply with all applicable terms (pages 1 - 4), General Conditions (pages 5 - 19), and additional terms below.

<p>B. NAVIGABLE WATERS</p>	<p>Navigable Waters of the U.S. are defined as those waters that are subject to the ebb and flow of the tide in addition to the non-tidal portions of the following federally-designated waters in Maine (the Kennebec River to Moosehead Lake, the Penobscot River to the confluence of the East and West Branch at Medway and, Lake Umbagog within the State of Maine) (Section 10 Rivers and Harbors Act of 1899). The jurisdictional limits are the mean high water mark (MHW) in tidal waters and the ordinary high water mark (OHWM) in non-tidal portions of the federally-designated navigable rivers. For the purposes of these GPs, fill placed in the area between the mean high water mark (MHW) and the high tide line (HTL), and in the bordering and contiguous wetlands to tidal waters are also reviewed in this Navigable Waters section.</p> <p>Activities not meeting the Self-Verification terms below require Pre-Construction Notification and activities not meeting the Pre-Construction Notification terms below require an application for an Individual Permit.</p>
<p>GENERAL PERMIT #</p>	<p>PRE-CONSTRUCTION NOTIFICATION</p>
<p>1. Repair, Replacement, and Maintenance of Authorized Structures and Fills <i>*See GC 25 for pile driving and removal conditions.</i></p>	<p>SELF-VERIFICATION</p> <p>Repair, replacement, or maintenance of previously authorized, currently serviceable structures or fills, provided:</p> <ul style="list-style-type: none"> • Conditions of the original authorization apply. • No expansion or change in use. Shall be rebuilt in same footprint, however minor deviations in design allowed. • The repair, rehabilitation, or replacement of those structures or fills destroyed or damaged by storms, floods, fire or other discrete events is authorized, provided that work is commenced, or is under contract to commence, within two years of the date of their destruction or damage. • In-water work is conducted “in-the-dry” (see GC.24). • No impacts to special aquatic sites (SAS) (incl. submerged aquatic vegetation, SAV), impacts to natural rocky habitat ≤100 SF, and impacts to intertidal area ≤1,000 SF • Slope stabilization is ≤500 LF in total length as measured below the plane of the HTL and is ≤200 LF in total length as measured below the plane of the MHW or OHWM. Vertical structures are ≤200 LF in total length as measured below the plane of the MHW or OHWM and are ≤18 inches waterward of existing face. • Dam and flood control, or levee work does not alter water levels or flood elevations. • Discharge of accumulated bottom sediments from or through a dam is not more than <i>de minimus</i>. • Tide gate work has a Corps-approved operation and maintenance plan and no effect to hydraulic regime, or tide gates that solely convey stormwater and/or Maine National Pollutant Discharge Elimination System-permitted discharges. <p>PRE-CONSTRUCTION NOTIFICATION</p> <p>Repair, replacement, or maintenance of previously authorized structures or fills not eligible for SV, provided:</p> <ul style="list-style-type: none"> • ≤0.5 acre temporary or permanent impacts, fill, excavation, and/or secondary impacts. • Temporary and/or permanent fill or excavation in SAV <1,000 SF • Permanent fill or excavation in other SAS <4,300 SF

SELF-VERIFICATION (SV)

PRE-CONSTRUCTION NOTIFICATION (PCN)

2. Moorings

Private, non-commercial, non-rental, single-boat moorings, provided:

- Authorized by the local harbormaster/town.
- Not associated with any boating facility (e.g. marinas).
- Not located within a Federal Navigational Project (other than in a Federal Anchorage) or within a distance of three times the authorized depth of a Federal Navigation Project. Moorings in a Federal Anchorage must not be associated with a boating facility and must not be for rent.
- No interference with navigation.
- Mooring is not located in SAS (incl. SAV) or intertidal areas.

Minor relocation of previously authorized moorings, provided:

- Authorized by the local harbormaster/town.
- Relocation is not within a Federal Navigational Project (other than in a Federal Anchorage) or within a distance of three times the authorized depth of a Federal Navigation Project.
- No interference with navigation.
- Relocated mooring is not located in SAS (incl. SAV) or intertidal areas.

**SV Moorings above do not require a SVNF.*

Moorings not eligible for SV and don't require an IP. This includes private moorings with no harbormaster or means of local approval or moorings associated with a boating facility (e.g. marina).

Locating new moorings in SAS (incl. SAV) shall be avoided to the maximum extent practicable. If SAS cannot be avoided, consideration shall be given to alternative mooring systems that prevents mooring chains from resting or dragging on the bottom substrate at all tides.

An IP is required for moorings located within the horizontal limits, or with moored vessels that extend into the horizontal limits of a Federal Navigation Project (other than in a Federal Anchorage).

3. Structures, Floats, and Lifts

Reconfiguration of such existing authorized structures with all intertidal work conducted "in-the-dry" (see GC 24).

Minor relocation of previously authorized floats provided:

- Relocation is not into a Federal Navigation Project or within a distance of three times the authorized depth of a Federal Navigation Project (other than a Federal Anchorage).
- No interference with navigation.
- Not relocated in or within 25 feet of SAV.
- Seasonal floats are stored above the MHHM and not on wetland (incl. salt marsh).

New structures, floats, and/or lifts including floatways/skidways, built to access waterway (both seasonal and permanent). Includes pile-supported, solid fill-supported, and crib-supported structures. Also includes expansions to existing authorized boating facilities (e.g. marinas).
Provided:

- <1 acre temporary or permanent impacts, fill, excavation, and/or secondary impacts.
- Temporary and/or permanent fill or excavation in SAV <1,000 SF
- Permanent fill or excavation in other SAS <4,300 SF

*See GC 25 for pile driving and pile removal conditions.

New private, non-commercial ramp and float structures attached to land (no piers) or new floats provided:

- Not located in or within a distance of three times the authorized depth of a Federal Navigation Project.
- No interference with navigation.
- No structure extends across >25% of the waterway width at mean low water.
- Not located in or within 25 feet of SAV.
- Ramp is <150 LF over salt marsh waterward of the MHHM and is ≥1:1 height:width ratio over salt marsh.

Compliance with the following is recommended:

- *Lowest part of floats are ≥18 inches above the substrate during all tides.*
- *Structures are ≥1:1 height:width ratio over salt marsh.*
- *Structures and floats are not located in or within 25 feet of SAV.*
- *Moored vessels are not positioned over SAV.*
- *Structures attached to land are located ≥ 25 feet from the property line (The Corps may require a letter of no objection from the abutter if located within 25 feet of the property line.)*

SELF-VERIFICATION (SV)

PRE-CONSTRUCTION NOTIFICATION (PCN)

<p><i>Cont'd from page 29</i></p>	<ul style="list-style-type: none"> Ramp and floats attached to land are located ≥ 25 feet from the property line. Seasonal ramp and floats are stored above the HTL and not on wetland (incl. salt marsh). <p>Compliance with the following is recommended:</p> <ul style="list-style-type: none"> <i>Lowermost part of floats is ≥ 18 inches above the substrate during all tides.</i> 	<ul style="list-style-type: none"> No structure extends across $> 25\%$ of the waterway width at mean low water. Not located within a distance of three times the authorized depth of a Corps Federal Navigation Project. <p>An IP is required for structures, floats, and/or lifts including floatways/skidways, located in such that they and/or vessels docked or moored at them are within the horizontal limits of a Corps Federal Navigation Project. An IP is also required for structures and floats associated with a new or previously unauthorized boating facility (e.g. marinas).</p> <p>Aids and temporary structures not eligible for SV.</p>
<p>4. Aids to Navigation and Temporary Recreational Structures</p>	<p>Aids to navigation and regulatory markers which are approved by and installed in accordance with the requirements of the U.S. Coast Guard. (See 33 CFR 66, Chapter I, subchapter C). *These SV Aids do not require a S/VNF.</p> <p>Temporary buoys, markers, floats, etc. for recreational use during specific events, provided:</p> <ul style="list-style-type: none"> They are removed within 30 days after the specific event has concluded. No interference with navigation. No impact to SAV. 	
<p>5. Dredging, Disposal of Dredged Material, Beach Nourishment, and Rock Removal and Relocation</p>	<p>Maintenance dredging of $< 1,000$ CY for navigational purposes with upland disposal including return water from upland contained disposal area, provided:</p> <ul style="list-style-type: none"> Proper siltation controls are used. No expansion of footprint. No dredging in or within a distance of three times the authorized depth of a Federal Navigation Project. Dredging operation is limited to Nov. 8th to Apr. 9th (it is recommended that in areas populated by winter flounder, dredging should cease by March 15th). No impacts to SAS (incl. SAV), impacts to natural rocky habitat ≤ 100 SF, and impacts to intertidal area $\leq 1,000$ SF. No dredging within 25 feet of SAV. No dredging in or within 100 feet of shellfish areas. No blasting. No dredging in designated or proposed critical habitat for endangered species. 	<p>Maintenance dredging not eligible for SV and new dredging $< 25,000$ CY Includes return water from upland contained disposal areas. Disposal includes:</p> <ul style="list-style-type: none"> Upland. Beach nourishment (above MHW line) of any area provided the dredging's primary purpose is navigation or the sand is from an upland source. Open water & confined aquatic disposal if Corps finds the material suitable. <p>Beach nourishment associated with dredging when the primary purpose is not navigation requires at least a PCN.</p> <p>Temporary and/or permanent fill or excavation in SAV $< 1,000$ SF and Permanent fill or excavation in other SAS $< 4,300$ SF</p>

SELF-VERIFICATION (SV)

PRE-CONSTRUCTION NOTIFICATION (PCN)

<p>6. U.S. Coast Guard Approved Bridges and Causeways</p>	<p>Discharges of dredged or fill material associated with U.S. Coast Guard Approved Bridges and Causeways, provided:</p> <ul style="list-style-type: none"> • In-water work is conducted “in-the-dry” (see GC 24). • Discharge of dredged or fill material <15,000 SF • No impacts to SAS (incl. SAV), impacts to natural rocky habitat ≤100 SF, and impacts to intertidal area ≤1,000 SF <p>Compliance with the following is recommended:</p> <ul style="list-style-type: none"> • <i>Discharge of dredged or fill material should not occur within 100 feet of SAV or within 25 feet of natural rocky habitat or other SAS.</i> <p><i>Note: new causeways and approach fills are not eligible for SV.</i></p>	<p>Discharges of dredged or fill material associated with U.S. Coast Guard Approved Bridges and Causeways not eligible for SV, provided:</p> <ul style="list-style-type: none"> • <1 acre temporary or permanent impacts, fill, excavation, and/or secondary impacts. • Temporary and/or permanent fill or excavation in SAV <1,000 SF • Permanent fill or excavation in other SAS <4,300 SF
<p>7. Bank and Shoreline Stabilization Including Living Shorelines (see also GC 28)</p>	<p>Bank and shoreline stabilization activities, provided:</p> <ul style="list-style-type: none"> • In-water work is conducted “in-the-dry” (see GC 24). • Fill is ≤500 LF in total length as measured below the plane of the HTL and is ≤200 LF in total length as measured below the plane of the MHHW or OHWM (includes total for more than one bank). Replacement vertical structures are ≤200 LF in total length as measured below the plane of the MHHW or OHWM and are ≤18 inches waterward of existing face. • Fill placed below HTL is ≤1 CY per linear foot. • Stone revetment is comprised of angular material. • No fills angled steeper than 1H:1V. • No impacts to SAS (incl. SAV), impacts to natural rocky habitat ≤100 SF, and impacts to intertidal or shellfish areas ≤1,000 SF • No new groins, breakwaters, or jetties. 	<p>Bank and shoreline stabilization activities not eligible for SV, provided:</p> <ul style="list-style-type: none"> • <1 acre temporary or permanent impacts, fill, excavation, and/or secondary impacts, provided: • Temporary and/or permanent fill or excavation in SAV <1,000 SF • Permanent fill or excavation in other SAS <4,300 SF
<p>8. Residential, Commercial and Institutional Developments, and Recreational Facilities</p>	<p>Not Eligible</p>	<p>Residential, commercial and institutional developments and recreational facilities, provided:</p> <ul style="list-style-type: none"> • <1 acre temporary or permanent impacts, fill, excavation, and/or secondary impacts, provided: • Temporary and/or permanent fill or excavation in SAV <1,000 SF • Permanent fill or excavation in other SAS <4,300 SF <p>Conversions of previously authorized pile-supported buildings over navigable waters to residences, offices, or other non-water dependent uses require PCN. Floating house boats or businesses on floats require PCN.</p>

SELF-VERIFICATION (SV)

PRE-CONSTRUCTION NOTIFICATION (PCN)

<p>9. Utility Line Activities (see also GC 30)</p>	<p>Repair, replacement, or maintenance of previously authorized, currently serviceable utilities with no expansion or change in use, provided:</p> <ul style="list-style-type: none"> • Conditions of the original authorization apply. • In-water work limited to Nov. 8th to Apr. 9th. • Trenching or filling confined to existing footprint and <100 LF; trenches shall be backfilled immediately. • Jet-plow, fluidization, or other direct burial methods confined to existing footprint and <200 LF • No impacts to SAS (incl. SAV), impacts to natural rocky habitat ≤100 SF, and impacts to intertidal or shellfish areas ≤1,000 SF • No work in designated or proposed critical habitat for endangered species. <p>New work in, over, or under navigable waters including new outfalls and any intake structure work requires PCN.</p> <p>Aerial utility lines over navigable waters requires PCN.</p>	<p>Those utility activities not eligible for SV, provided:</p> <ul style="list-style-type: none"> • <1 acre temporary or permanent impacts, fill, excavation, and/or secondary impacts. • Temporary and/or permanent fill or excavation in SAV <1,000 SF • Permanent fill or excavation in other SAS <4,300 SF
<p>10. Linear Transportation Projects (for stream crossings refer to GPs 6 and 22)</p>	<p>Not Eligible</p>	<p>Linear transportation projects, provided:</p> <ul style="list-style-type: none"> • <1 acre temporary or permanent impacts, fill, excavation, and/or secondary impacts. • Temporary and/or permanent fill or excavation in SAV <1,000 SF • Permanent fill or excavation in other SAS <4,300 SF
<p>11. Mining Activities</p>	<p>Not Eligible</p>	<p>Not Eligible</p>
<p>12. Boat Ramps and Marine Railways</p>	<p>No new boat ramps or marine railways.</p> <p>In-water work is conducted “in-the-dry” (see GC 24).</p> <p>No impacts to SAS (incl. SAV), impacts to natural rocky habitat ≤100 SF, and impacts to intertidal or shellfish areas ≤1,000 SF</p> <p>Boat ramp and marine railway work not eligible for maintenance (i.e. not currently serviceable) may be replaced “in-kind” with minor deviations provided:</p> <ul style="list-style-type: none"> • Work is confined to the intertidal zone. • No impacts to SAS (incl. SAV), impacts to natural rocky habitat ≤100 SF, and impacts to intertidal or shellfish areas ≤1,000 SF 	<p>Those ramps and railways not eligible for SV, provided:</p> <ul style="list-style-type: none"> • <1 acre temporary or permanent impacts, fill, excavation, and/or secondary impacts, provided: • Temporary and/or permanent fill or excavation in SAV <1,000 SF • Permanent fill or excavation in other SAS <4,300 SF

SELF-VERIFICATION (SV)

PRE-CONSTRUCTION NOTIFICATION (PCN)

<p>13. Land and Water-Based Renewable Energy Generation Facilities and Hydropower Projects</p>	<p>Not Eligible</p>	<p>Work associated with those facilities and projects, provided:</p> <ul style="list-style-type: none"> • <1 acre temporary or permanent impacts, fill, excavation, and/or secondary impacts. • Temporary and/or permanent fill or excavation in SAV <1,000 SF • Permanent fill or excavation in other SAS <4,300 SF <p>For each single and complete project, no more than 10 generation units (e.g., wind turbines or hydrokinetic devices) may be authorized.</p> <p>No new impoundments.</p>
<p>14. Reshaping Existing Ditches and Mosquito Management</p>	<p>≤500 LF of drainage ditch will be modified. The reshaping of the ditch cannot increase drainage capacity beyond the original as-built capacity nor can it expand the area drained by the ditch as originally constructed (i.e., the capacity of the ditch shall be the same as originally constructed and it cannot drain additional wetlands or other waters of the U.S.).</p> <p>No new ditches or relocation of drainage ditches constructed in waters of the U.S.; the location of the centerline of the reshaped drainage ditch shall be approximately the same as the location of the centerline of the original drainage ditch.</p> <p>No impacts to SAS (incl. SAV), impacts to natural rocky habitat ≤100 SF, and impacts to intertidal or shellfish areas ≤1,000 SF</p>	<p>Those activities not eligible for SV, provided:</p> <ul style="list-style-type: none"> • <1 acre temporary or permanent impacts, fill, excavation, and/or secondary impacts. • Temporary and/or permanent fill or excavation in SAV <1,000 SF • Permanent fill or excavation in other SAS <4,300 SF
<p>15. Response Operations for Oil or Hazardous Substances</p>	<p>The SVNf or a surrogate state reporting form may be submitted after-the-fact for spill response activities.</p> <p>This GP also authorizes the use of temporary structures and fills in waters of the U.S. for spill response training exercises (<i>SVNF is required prior to the activity</i>), provided:</p> <ul style="list-style-type: none"> • No impacts to SAS (incl. SAV), impacts to natural rocky habitat ≤100 SF, impacts to intertidal or shellfish areas ≤1,000 SF, and impacts to tidal resources <0.5 acre 	<p>Those response operations not eligible for SV, provided:</p> <ul style="list-style-type: none"> • <1 acre temporary or permanent impacts, fill, excavation, and/or secondary impacts. • Temporary and/or permanent fill or excavation in SAV <1,000 SF • Permanent fill or excavation in other SAS <4,300 SF
<p>16. Cleanup of Hazardous and Toxic Waste</p>	<p>Only booms placed for hazardous and toxic waste containment and absorption and prevention are eligible for SV. <i>A SVNf is not required for these eligible containment booms.</i></p>	<p>Cleanup activities not eligible for SV, provided:</p> <ul style="list-style-type: none"> • <1 acre temporary or permanent impacts, fill, excavation, and/or secondary impacts. • Temporary and/or permanent fill or excavation in SAV <1,000 SF • Permanent fill or excavation in other SAS <4,300 SF <p>An IP is require for the establishment of new disposal sites or expanding existing sites used for the disposal of hazardous or toxic waste.</p>

SELF-VERIFICATION (SV)

PRE-CONSTRUCTION NOTIFICATION (PCN)

<p>17. Scientific Measurements Devices</p>	<p>Those scientific measurements devices, provided:</p> <ul style="list-style-type: none"> • Devices do not restrict or concentrate movement of aquatic organisms. • No interference with navigation. • No blasting. • No biological sampling devices. • No impacts to SAS (incl. SAV), impacts to natural rocky habitat ≤100 SF, impacts to intertidal areas ≤1,000 SF, and impacts to tidal resources ≤0.5 acre • Upon completion of use, the devices and any associated structures or fills are removed in their entirety. 	<p>Those scientific measurements devices not eligible for SV, provided:</p> <ul style="list-style-type: none"> • <1 acre temporary or permanent impacts, fill, excavation, and/or secondary impacts. • Temporary and/or permanent fill or excavation in SAV <1,000 SF • Permanent fill or excavation in other SAS <4,300 SF
<p>18. Survey Activities</p>	<p>Those survey activities, provided:</p> <ul style="list-style-type: none"> • No blasting. • No interference with navigation. • No seismic exploratory operations. • No oil and gas exploration. • No trenching or other silt-producing activities. • No fill for roads or construction pads. • No impacts to SAS (incl. SAV), impacts to natural rocky habitat ≤100 SF, impacts to intertidal areas ≤1,000 SF, and impacts to tidal resources <0.5 acre • No blasting. • No biological sampling devices. <p><i>A SVNF is not required for required sediment sampling for Corps-regulated dredge proposals.</i></p>	<p>Those survey activities not eligible for SV, provided:</p> <ul style="list-style-type: none"> • <1 acre temporary or permanent impacts, fill, excavation, and/or secondary impacts. • Temporary and/or permanent fill or excavation in SAV <1,000 SF • Permanent fill or excavation in other SAS <4,300 SF
<p>19. Agricultural Activities</p> <p>20. Fish and Wildlife Harvesting, Enhancement and Attraction Devices and Activities <i>(for aquaculture refer to GP 23)</i></p>	<p>Not Eligible</p> <p>Those devices and activities, provided:</p> <ul style="list-style-type: none"> • No impacts to SAS (incl. SAV), impacts to natural rocky habitat ≤100 SF, impacts to intertidal areas ≤1,000 SF, and impacts to tidal resources ≤0.5 acre • No interference with navigation. • No artificial reefs or enclosures • No impoundments or semi-impoundments for the culture or holding of motile species such as lobster, or the use of covered oyster trays or clam racks. • Structures and shell hash should not be located within 25 feet of SAV. • All gear, except for mooring tackle, when not in use on the site is stored in an upland location above the MHHWM and not on wetland (incl. salt marsh). <p><i>A SVNF is not required for these eligible devices and activities.</i></p>	<p>Not Eligible</p> <p>Those devices and activities not eligible for SV, provided:</p> <ul style="list-style-type: none"> • <1 acre temporary or permanent impacts, fill, excavation, and/or secondary impacts. • Temporary and/or permanent fill or excavation in SAV <1,000 SF • Permanent fill or excavation in other SAS <4,300 SF <p>Impoundments or semi-impoundments of waters of the U.S. for the culture or holding of motile species such as lobster and new fish weirs with an impounded area <0.5 acre</p>

SELF-VERIFICATION (SV)

PRE-CONSTRUCTION NOTIFICATION (PCN)

<p>21. Habitat Restoration, Establishment, and Enhancement</p>	<p>Those activities, provided:</p> <ul style="list-style-type: none"> No impacts to SAS (incl. SAV), impacts to natural rocky habitat ≤100 SF, impacts to intertidal areas ≤1,000 SF, and impacts to tidal resources <0.5 acre No thin layer deposition for salt marsh restoration. SAS planting and transplanting is <100 SF No artificial or living reefs. The activity is authorized in writing by a local, state, or non-Corps federal environmental agency. Water impoundments require PCN. No conversion of i) a stream to wetland or vice versa, wetland to a pond or uplands, and ii) one wetland type to another. No dam removal. 	<p>Those activities not eligible for SV provided those activities are proactive and result in net increases in aquatic resource functions and services.</p>
<p>22. Stream and Wetland Work and Crossings (see also GC 29) (see GP 6 for bridges & causeways)</p>	<p>Not Eligible</p>	<p>Those crossings of tidal navigable water not including bridges and causeways, provided:</p> <ul style="list-style-type: none"> <1 acre temporary or permanent impacts, fill, excavation, and/or secondary impacts. Temporary and/or permanent fill or excavation in SAV <1,000 SF Permanent fill or excavation in other SAS <4,300 SF
<p>23. Aquaculture* (see also GC 32)</p>	<p>Shellfish and marine algae installations that do not exceed 400 SF in area, provided:</p> <ul style="list-style-type: none"> Signed approval from Harbormaster or appropriate Town Official. No enclosures or impoundments. Not located in or within a distance of three times the authorized depth of a Federal Navigation Project. Not located in or impinge upon the value of any National Lands or Federal Properties. No impacts to SAS (incl. SAV), impacts to natural rocky habitat ≤100 SF, and impacts to intertidal and shellfish areas ≤1,000 SF No structures, cages, gear, or shell hash located in/within 25 feet of SAV. All gear, except for mooring tackle, when not in use on the site is stored in an upland location above the MHWM and not on wetland (incl. salt marsh). 	<p>Shellfish, finfish, and marine algae aquaculture (with the exception of Atlantic salmon and any other salmonid, or other federally-listed endangered or threatened species), or other aquaculture facilities with no more than minimal individual and cumulative impacts to environmental resources or navigation. This is inclusive but not limited to cages, nets, bags, racks, long lines, fences, posts, poles, predator screening, etc.</p> <p>*State of Maine Aquaculture guidelines are provided at: www.maine.gov/dmr/aquaculture/index.html</p>



Section VI: Self-Verification Notification Form
(for all tidal and non-tidal projects in Maine subject to Corps jurisdiction)

**US Army Corps
of Engineers**®
New England District

At least two weeks before work commences, complete all fields (write “none” if applicable) below or use the fillable form found at www.nae.usace.army.mil/Missions/Regulatory/State-General-Permits/Maine-General-Permit/ The two-week lead time is not required for emergency situations. **Send this form, an Official Species List, and project plans to the following email address: cenae-r-me@usace.army.mil**

Maine Project Office
U.S. Army Corps of Engineers
442 Civic Center Drive, Suite 350
Augusta, Maine 04330

State Permit #: _____
Date of State Permit: _____
State Project Manager: _____

Permittee: _____
Address, City, State, Zip: _____
Email, Phone: _____

Agent: _____
Address, City, State, Zip: _____
Email, Phone: _____

Contractor: _____
Address, City, State, Zip: _____
Email, Phone: _____

Project Name: _____
Address, City, State, Zip: _____
Lat °N, Long °W: _____ Tax Map/Lot: _____
Waterway Name: _____
Description of Work: _____

Proposed Starting Date: _____ Proposed Finish Date: _____

Area of wetland impact (SF): Permanent: _____ Temporary: _____
Area of waterway impact (SF): Permanent: _____ Temporary: _____

Work will be done under the following Section V General Permits (circle all that apply):
I. Inland Waters and wetlands: 1 2 3 4 5 6 7 8 9 10 11 12 13 14 15 16 17 18 19 20 21 22 23
II. Navigable Waters: 1 2 3 4 5 6 7 8 9 10 11 12 13 14 15 16 17 18 19 20 21 22 23

Have MHPC and all five federally-recognized tribes in Maine been notified of the proposed work? _____ Yes _____ No

Your signature below, as permittee, indicates that you accept and agree to comply with the terms, eligibility criteria, and general conditions for Self-Verification under the Maine General Permit.

Permittee Signature: _____ Date: _____



**US Army Corps
of Engineers**®
New England District

Section VII: Content of a Pre-Construction Notification

In addition to the following required information, the applicant must provide additional information as the Corps deems essential to make a public interest determination including, where applicable, a determination of compliance with the Section 404(b)(1) guidelines or ocean dumping criteria. Such additional information may include environmental data and information on alternate methods and sites as may be necessary for the preparation of the required environmental documentation. For a more comprehensive checklist, go to www.nae.usace.army.mil/missions/regulatory >> Forms >> Application and Plan Guideline Checklist. Please check with the Corps for project-specific requirements.

Information required for all projects:

- DIGITAL SUBMISSIONS ARE ENCOURAGED (email PCN to cenae-r-me@usace.army.mil)
- Completed Corps application form (ENG Form 4345 attached below or found electronically at www.usace.army.mil/Missions/Civil-Works/Regulatory-Program-and-Permits/Obtain-a-Permit) or appropriate state application form. Forms may need to be supplemented to include the information noted below.
- Proof of notification to MHPC and all five federally-recognized tribes (see Section VIII for contact info).
- Official Species List for any federally-listed endangered or threatened species and email address of the person who generated the list.
- Drawings, sketches, or plans (detailed engineering plans and specifications are not required) that are legible, reproducible (color is encouraged, but features must be distinguishable in black and white), no larger than 8.5"x11", with bar scale (plans overlaid on aerial photos are discouraged). Wetland area impact sheets shall have the highest resolution possible to show work within Corps jurisdiction (do not just reduce project overview or cut large-scale plan into quadrant sheets). Provide locus map and a plan overview of the entire property with a key index to the individual impact sheets. A locus map be on a section of color USGS topographic map.
- Include:
 - All direct, secondary, permanent and temporary effects the project would cause, including the anticipated amount of impacts to waters of the U.S. expected to result from the activity, in acres, linear feet, or other appropriate unit of measure.
 - Any historic permanent fill associated with each single and complete project.
 - Cross-section views of all wetland and waterway fill areas and wetland replication areas.
 - Document on project plans wetlands, other special aquatic sites (SAS) including vegetated shallows (or submerged aquatic vegetation, SAV) and mudflats, natural rocky habitat, shellfish areas, vernal pools, and other waters, such as lakes and ponds, and perennial, and intermittent streams on the project site (GC1).
 - MLW line, MHW mark, and HTL elevations in tidal waters. Show OHWM elevation in lakes and non-tidal streams.
 - Existing and proposed conditions.**
- Volume, type, and source of fill material to be discharged into waters and wetlands, including the area(s) (in square feet or acres) of fill in wetlands, below OHWM in inland waters and below the HTL in coastal waters.
- If applicable, a restoration plan showing how all temporary fills and structures will be removed and the area restored to pre-project conditions (see GC 21).

Information that may be required:

- Photographs of wetland/waterway to be impacted. Photos at low tide are preferred for work in tidal waters.
- For drawings, sketches, or plans:
 - The vertical datum for all coastal projects and projects in towns bordering coastal waters shall be in U.S. survey feet and referenced to MLLW and include current tidal epoch, with a reference chart showing conversion factor to the North American Vertical Datum of 1988. Do not use local datum. See www.nae.usace.army.mil/missions/regulatory >> Forms and Publications >> Vertical Datum - FEMA (Jul 2007);
 - The horizontal state plane coordinates shall be shown on plan and elevation views and shall be in the North American Datum of 1983 (NAD83) State Plane Coordinate System in U.S. survey feet.
- For the construction of a filled area or pile or float-supported platform, the use of, and specific structures to be erected on, the fill or platform.
- For the discharge of dredged or fill material into waters of the U.S. or the transportation of dredged material for the purpose of disposing of it in ocean waters, the source of the material; the purpose of the discharge, a description of the type, composition and quantity of the material; the method of transportation and disposal of the material; and the location of the disposal site.
- For the discharge of dredged or fill material into waters of the U.S., include a statement describing how impacts to waters of the U.S. are to be avoided and minimized. Include either a statement describing how impacts to waters of the U.S. are to be compensated for or a statement explaining why compensatory mitigation should not be required for the proposed impacts.
- Purpose and need for the proposed activity;
- Limits and coordinates of any Federal Navigation Project in the vicinity of the project area.
- Limits and coordinates of any proposed mooring field, reconfiguration zone or aquaculture activity. Provide coordinates for all corners;
- Schedule of construction/activity;
- Names and addresses of adjoining property owners;
- Location and dimensions of adjacent structures;
- Alternatives analysis;
- Wetland delineation data sheets;
- List of authorizations required by other federal, interstate, state, or local agencies for the work, including all approvals received or denials already made.
- Identification and description of potential impacts to Essential Fish Habitat (see GC 17).
- Identification of potential discharges of pollutants to waters, including potential impacts to impaired waters, in the project area.
- Invasive Species Control Plan (see GC 22). For sample control plans, see www.nae.usace.army.mil/Missions/Regulatory/Invasive-Species
- Wildlife Action Plan (WAP) maps. Contact the Maine Department of Inland Fisheries & Wildlife (Section VIII) or online at www.maine.gov/ifw/wildlife/conservation/action_plan.html

Information for dredging projects that may be required:

- Sediment testing, including physical (e.g., grain-size analysis), chemical and biological testing. For projects proposing open water disposal, applicants must contact the Corps as early as possible regarding sampling and testing protocols. Sampling and testing of sediments without such contact should not occur and if done, would be at the applicant's risk.
- The area in square feet and volume of material to be dredged below mean high water.
- Existing and proposed water depths.
- Type of dredging equipment to be used.
- Nature of material (e.g., silty sand).
- Any existing sediment grain size and bulk sediment chemistry data for the proposed or any nearby projects.
- Information on the location and nature of municipal or industrial discharges and occurrence of any contaminant spills in or near the project area.
- Shellfish survey.
- Location of the disposal site (include locus sheet).
- Identification and description of any potential impacts to Essential Fish Habitat.
- Delineation of submerged aquatic vegetation (e.g., eelgrass beds).

Information for tidal crossing projects that may be required:

- A graphic longitudinal elevation profile plot of the tidal stream channel thalweg, both up and downstream of the proposed project site. Thalweg elevations shall extend from the crossing to beyond the zone of scour, channel widening, or other channel alteration resulting from the present or pre-existing crossings. The profile plot should include labeled elevations for the:
 - crossing invert and top of the inlet and outlet
 - roadbed crown
 - lowest and highest recorded tides at the site
 - reference datums, such as MLLW, MHHW, and astronomical high tide
 - hydraulic controls and nearest crossings that could influence or be influenced by the proposed crossing
- A graphic plot of continuous tidal water levels recorded up and downstream, simultaneously, of the proposed crossing for an entire lunar cycle. The water level plot should include labeled elevations for the:
 - crossing invert and crossing top at the inlet and outlet
 - roadbed crown
 - reference datums, such as MLLW, MHHW, and astronomical high tide
- A map showing projected extents of maximum flooding within the area influenced by the crossing under current conditions and as a result of sea level rise. The present minimum sea level rise scenario suggested for planning purposes by the Maine Climate Council Scientific and Technical Subcommittee is the Intermediate Scenario, which projects an increase of 3.0-4.6 feet by 2100.

Information for aquaculture projects that may be required:

- Maine Aquaculture guidelines and joint Corps/Maine DMR applications may be found at: www.maine.gov/dmr/aquaculture/index.htm
- In addition to the information required above, applications should also include:
 - Results of coordination with Harbor Master and U.S. Coast Guard
 - Whether canopy predator nets are being used.

U.S. Army Corps of Engineers (USACE)
APPLICATION FOR DEPARTMENT OF THE ARMY PERMIT
 33 CFR 325. The proponent agency is CECW-CO-R.

Form Approved -
OMB No. 0710-0003
Expires: 02-28-2022

The public reporting burden for this collection of information, OMB Control Number 0710-0003, is estimated to average 11 hours per response, including the time for reviewing instructions, searching existing data sources, gathering and maintaining the data needed, and completing and reviewing the collection of information. Send comments regarding the burden estimate or burden reduction suggestions to the Department of Defense, Washington Headquarters Services, at whs.mc-alex.esd.mbx.dd-dod-information-collections@mail.mil. Respondents should be aware that notwithstanding any other provision of law, no person shall be subject to any penalty for failing to comply with a collection of information if it does not display a currently valid OMB control number. PLEASE DO NOT RETURN YOUR APPLICATION TO THE ABOVE EMAIL.

PRIVACY ACT STATEMENT

Authorities: Rivers and Harbors Act, Section 10, 33 USC 403; Clean Water Act, Section 404, 33 USC 1344; Marine Protection, Research, and Sanctuaries Act, Section 103, 33 USC 1413; Regulatory Programs of the Corps of Engineers; Final Rule 33 CFR 320-332. Principal Purpose: Information provided on this form will be used in evaluating the application for a permit. Routine Uses: This information may be shared with the Department of Justice and other federal, state, and local government agencies, and the public and may be made available as part of a public notice as required by Federal law. Submission of requested information is voluntary, however, if information is not provided the permit application cannot be evaluated nor can a permit be issued. One set of original drawings or good reproducible copies which show the location and character of the proposed activity must be attached to this application (see sample drawings and/or instructions) and be submitted to the District Engineer having jurisdiction over the location of the proposed activity. An application that is not completed in full will be returned. System of Record Notice (SORN). The information received is entered into our permit tracking database and a SORN has been completed (SORN #A1145b) and may be accessed at the following website: <http://dpcl.d.defense.gov/Privacy/SORNsIndex/DOD-wide-SORN-Article-View/Article/570115/a1145b-ce.aspx>

(ITEMS 1 THRU 4 TO BE FILLED BY THE CORPS)

1. APPLICATION NO.	2. FIELD OFFICE CODE	3. DATE RECEIVED	4. DATE APPLICATION COMPLETE
--------------------	----------------------	------------------	------------------------------

(ITEMS BELOW TO BE FILLED BY APPLICANT)

5. APPLICANT'S NAME First - Middle - Last - Company - E-mail Address -			8. AUTHORIZED AGENT'S NAME AND TITLE (agent is not required) First - Middle - Last - Company - E-mail Address -		
6. APPLICANT'S ADDRESS: Address- City - State - Zip - Country -			9. AGENT'S ADDRESS: Address- City - State - Zip - Country -		
7. APPLICANT'S PHONE NOs. w/AREA CODE a. Residence b. Business c. Fax			10. AGENTS PHONE NOs. w/AREA CODE a. Residence b. Business c. Fax		

STATEMENT OF AUTHORIZATION

11. I hereby authorize, _____ to act in my behalf as my agent in the processing of this application and to furnish, upon request, supplemental information in support of this permit application.

SIGNATURE OF APPLICANT DATE

NAME, LOCATION, AND DESCRIPTION OF PROJECT OR ACTIVITY

12. PROJECT NAME OR TITLE (see instructions)			
13. NAME OF WATERBODY, IF KNOWN (if applicable)		14. PROJECT STREET ADDRESS (if applicable) Address	
15. LOCATION OF PROJECT Latitude: N Longitude: W		City - State- Zip-	
16. OTHER LOCATION DESCRIPTIONS, IF KNOWN (see instructions) State Tax Parcel ID Municipality Section - Township - Range -			

17. DIRECTIONS TO THE SITE

18. Nature of Activity (Description of project, include all features)

19. Project Purpose (Describe the reason or purpose of the project, see instructions)

USE BLOCKS 20-23 IF DREDGED AND/OR FILL MATERIAL IS TO BE DISCHARGED

20. Reason(s) for Discharge

21. Type(s) of Material Being Discharged and the Amount of Each Type in Cubic Yards:

Type Amount in Cubic Yards	Type Amount in Cubic Yards	Type Amount in Cubic Yards
-------------------------------	-------------------------------	-------------------------------

22. Surface Area in Acres of Wetlands or Other Waters Filled (see instructions)

Acres
or
Linear Feet

23. Description of Avoidance, Minimization, and Compensation (see instructions)

24. Is Any Portion of the Work Already Complete? Yes No IF YES, DESCRIBE THE COMPLETED WORK

25. Addresses of Adjoining Property Owners, Lessees, Etc., Whose Property Adjoins the Waterbody (if more than can be entered here, please attach a supplemental list).

a. Address-

City - State - Zip -

b. Address-

City - State - Zip -

c. Address-

City - State - Zip -

d. Address-

City - State - Zip -

e. Address-

City - State - Zip -

26. List of Other Certificates or Approvals/Denials received from other Federal, State, or Local Agencies for Work Described in This Application.

AGENCY	TYPE APPROVAL*	IDENTIFICATION NUMBER	DATE APPLIED	DATE APPROVED	DATE DENIED
_____	_____	_____	_____	_____	_____
_____	_____	_____	_____	_____	_____
_____	_____	_____	_____	_____	_____

* Would include but is not restricted to zoning, building, and flood plain permits

27. Application is hereby made for permit or permits to authorize the work described in this application. I certify that this information in this application is complete and accurate. I further certify that I possess the authority to undertake the work described herein or am acting as the duly authorized agent of the applicant.

SIGNATURE OF APPLICANT

DATE

SIGNATURE OF AGENT

DATE

The Application must be signed by the person who desires to undertake the proposed activity (applicant) or it may be signed by a duly authorized agent if the statement in block 11 has been filled out and signed.

18 U.S.C. Section 1001 provides that: Whoever, in any manner within the jurisdiction of any department or agency of the United States knowingly and willfully falsifies, conceals, or covers up any trick, scheme, or disguises a material fact or makes any false, fictitious or fraudulent statements or representations or makes or uses any false writing or document knowing same to contain any false, fictitious or fraudulent statements or entry, shall be fined not more than \$10,000 or imprisoned not more than five years or both.

Section VIII: Agency Contacts

1. Federal

U.S. Army Corps of Engineers
Maine Project Office
442 Civic Center Drive, Suite 350
Augusta, Maine 04330
(207) 623-8367; (207) 623-8206 (fax)
Email: cenae-r-me@usace.army.mil

U.S. Environmental Protection Agency
5 Post Office Square
Suite 100 (OEP05-2)
Boston, Massachusetts 02109-3912
(617) 918-1589

U.S. Fish and Wildlife Service
Maine Field Office
P.O. Box A
East Orland, Maine 04431
(207) 469-7300; (207) 902-1588 (fax)
(Federal endangered species)

National Marine Fisheries Service
Maine Field Office
17 Godfrey Drive, Suite 1
Orono, Maine 04473
(207) 866-7379; (207) 866-7342 (fax)
(Federal endangered species)

FEMA Region 1
Federal Insurance and Mitigation Division
99 High Street 6th Floor
Boston, Massachusetts 02110
(floodplains)

2. State of Maine

a. Department of Environmental Protection *(State permits & Water Quality Certifications)*

Augusta Regional Office
17 State House Station
Augusta, Maine 04333
(207) 287-7688

Southern Maine Regional Office
312 Canco Road
Portland, Maine 04103
(201) 822-6300

Federal Emergency Management Agency
99 High Street
Boston, Massachusetts 02110
(877) 336-2734
(Floodplain Management)

National Marine Fisheries Service
55 Great Republic Drive
Gloucester, Massachusetts 01930
(978) 281-9102; (978) 281-9301 (fax)
(Federal endangered species & EFH)

National Park Service
North Atlantic Region
15 State Street
Boston, Massachusetts 02109
(617) 223-5203
(Wild and Scenic Rivers)

Commander (dpb)
First Coast Guard District
One South Street - Battery Building
New York, New York 10004-1466
(212) 668-7021; (212) 668-7967 (fax)
(bridge permits)

Eastern Maine Regional Office
106 Hogan Road
Bangor, Maine 04401
(207) 941-4570

Northern Maine Regional Office
1235 Central Drive
Presque Isle, Maine 04769
(207) 764-0477

b. Department of Agriculture, Conservation and Forestry

i. Maine Land Use Planning Commission (LUPC) (*State permits & Water Quality Certifications for the unorganized areas of the State*)

Augusta Office
22 State House Station
Augusta, Maine 04333-0022
(207) 287-2631; (207) 287-7439 (fax)

Downeast Regional Office
106 Hogan Road, Suite 8
Bangor, Maine 04401
(207) 215-4685; (207) 941-4222 (fax)

Greenville Regional Office
43 Lakeview Drive
P.O. Box 1107
Greenville, Maine 04441
(207) 695-2466; (207) 695-2380 (fax)

Ashland Regional Office
45 Radar Road
Ashland, Maine 04732-3600
(207) 435-7963; (207) 435-7184 (fax)

Western Region Office
932 U.S. Route 2
East Wilton, Maine 04992
(207) 670-7492; (207) 287-7439 (fax)

Eastern Region Office
191 Main Street
East Millinocket, Maine 04430
(207) 399-2176; (207) 746-2243 (fax)

ii. Maine Coastal Program

21 State House Station
Augusta, Maine 04333
(207) 707-2324; (207) 624-6024 (fax)
(CZM consistency determinations)

iii. Division of Parks and Public Lands

22 State House Station
Augusta, Maine 04333
(207) 287-3061; (207) 287-6170 (fax)
(submerged lands leases)

iv. Maine Floodplain Management Program

17 Elkins Lane
Augusta, Maine 04333
(207) 287-8063
(floodplains)

c. Department of Marine Resources

21 State House Station
Augusta, Maine 04333
(207) 633-9500; (207) 624-6024 (fax)
(aquaculture leases/licenses)

3. Historic Properties

a. State Historic Preservation Officer (SHPO)

Kirk F. Mohny, Director
Maine Historic Preservation Commission
65 State House Station
Augusta, Maine 04333-0065
(207) 287-2132; (207) 287-2335 (fax)

b. Tribal Historic Preservation Officers (THPOs)

Houlton Band of Maliseet Indians
88 Bell Road
Littleton, Maine 04730
(207) 532-4273, x215; (207) 532-6883 (fax)
istjohn@maliseets.com

Passamaquoddy Tribe of Indians
Pleasant Point Reservation
P.O. Box 343
Perry, Maine 04667
(207) 853-2600; (207) 853-6039 (fax)
soctomah@gmail.com

Passamaquoddy Tribe of Indians
Indian Township Reservation
P.O. Box 301
Princeton, Maine 04668
(207) 796-2301; (207) 796-5256 (fax)
soctomah@gmail.com

Aroostook Band of Micmacs
7 Northern Road
Presque Isle, Maine 04769
(207) 764-1972; (207) 764-7667 (fax)
jdennis@micmac-nsn.gov

Penobscot Nation
Cultural and Historic Preservation Dept.
12 Wabanaki Way
Indian Island, Maine 04468
(207) 817-7471
chris.sockalexis@penobscotnation.org

Section IX: Definitions

Action Area: The “Endangered Species Consultation Handbook – Procedures for Conducting Consultation and Conference Activities Under Section 7 of the ESA,” defines action area as “all areas to be affected directly or indirectly by the federal action and not merely the immediate area involved in the action. [50 CFR 402.02].”

Agricultural Activities: The Clean Water Act exempts certain discharges associated with normal farming, ranching, and forestry activities such as plowing, cultivating, minor drainage, and harvesting for the production of food, fiber, and forest products, or upland soil and water conservation practices (Section 404(f)(1)(A)). Prospective permittees are strongly advised to contact the Corps for a determination of whether their activity is exempt or requires a permit.

Attendant Features: Occurring with or as a result of; accompanying.

Aquatic Habitat Restoration, Establishment and Enhancement: The Corps will decide if a project qualifies and must determine in consultation with federal and state agencies that the net effects are beneficial. The Corps may refer to Nationwide Permit 27 published in the January 6, 2017 Federal Register. Activities authorized here may include, but are not limited to: the removal of accumulated sediments; the installation, removal, and maintenance of small water control structures, dikes, and berms; the installation of current deflectors; the enhancement, restoration, or establishment of riffle and pool stream structure; the placement of in-stream habitat structures; modifications of the stream bed and/or banks to restore or establish stream meanders; the backfilling of artificial channels and drainage ditches; the removal of existing drainage structures; the construction of small nesting islands in inland waters; the construction of open water areas; the construction of native shellfish species habitat over unvegetated bottom for the purpose of habitat protection or restoration in tidal waters; shellfish seeding; activities needed to reestablish vegetation, including plowing or discing for seed bed preparation and the planting of appropriate wetland species; mechanized land clearing to remove non-native invasive, exotic, or nuisance vegetation; and other related activities. Only native plant species shall be planted at the site.

Biodegradable: A material that decomposes into elements found in nature within a reasonably short period of time and will not leave a residue of plastic or a petroleum derivative in the environment after degradation. Examples of biodegradable materials include jute, sisal, cotton, straw, burlap, coconut husk fiber (coir) or excelsior. In contrast, degradable plastics break down into plastic fragments that remain in the environment after degradation.

Boating facilities: These provide, rent or sell mooring space, such as marinas, yacht clubs, boat yards, dockominiums, town facilities, land/home owners, etc. Not classified as boating facilities are piers shared between two abutting properties or town mooring fields that charge an equitable user fee based on the actual costs incurred.

Bordering and Contiguous Wetlands: A bordering wetland is immediately next to its adjacent waterbody and may lie at, or below, the ordinary high water mark (mean high water mark in navigable waters) of that waterbody and is directly influenced by its hydrologic regime. Contiguous wetlands extend landward from their adjacent waterbody to a point where a natural or manmade discontinuity exists. Contiguous wetlands include bordering wetlands as well as wetlands that are situated immediately above the ordinary high water mark and above the normal hydrologic influence of their adjacent waterbody.

Brushing: The placement of tree boughs, wooden lath structure, or small-mesh fencing on mudflats, or any bottom disturbance (e.g., discing, plowing, raking, etc.), to enhance recruitment of shellfish.

Buffer Zone: The buffer zone of an FNP is equal to three times the authorized depth of the FNP.

Construction mats: Constructions, swamp and timber mats (herein referred to as “construction mats”) are generic terms used to describe structures that distribute equipment weight to prevent wetland damage while facilitating passage and providing work platforms for workers and equipment. They are comprised of sheets or mats made from a variety of materials in various sizes. A timber mat consists of large timbers bolted or cabled together. Corduroy roads, which are not considered to be construction mats, are cut trees and/or saplings with the

crowns and branches removed, and the trunks lined up next to one another. Corduroy roads are typically installed as permanent structures. Like construction mats, they are considered as fill whether they are installed temporarily or permanently.

Cumulative effects: See “Direct, secondary, and cumulative effects.”

Currently Serviceable: Useable as-is or with some maintenance, but not so degraded as to essential require reconstruction.

Direct, secondary, and cumulative effects:

Direct Effects: The loss of aquatic ecosystem within the footprint of the discharge of dredged or fill material. Direct effects are caused by the action and occur at the same time and place.

Secondary Effects: These are effects on an aquatic ecosystem that are associated with a discharge of dredged or fill materials, but do not result from the actual placement of the dredged or fill material. Information about secondary effects on aquatic ecosystems shall be considered prior to the time final Section 404 action is taken by permitting authorities. Some examples of secondary effects on an aquatic ecosystem are a) aquatic areas drained, flooded, fragmented, or mechanically cleared, b) fluctuating water levels in all impoundment and downstream associated with the operation of a dam, c) septic tank leaching and surface runoff from residential or commercial developments on fill, and d) leachate and runoff from a sanitary landfill located in waters of the U.S. See 40 CFR 230.11(h).

Cumulative Effects: The changes in an aquatic ecosystem that are attributable to the collective effect of a number of individual 1) discharges of dredged or fill material, or 2) structures. Although the impact of a particular discharge may constitute a minor change in itself, the cumulative effect of numerous such piecemeal changes can result in a major impairment of the water resources and interfere with the productivity and water quality of existing aquatic ecosystems. See 40 CFR 230(g).

Dredging:

Maintenance Dredging: Includes areas and depths previously authorized by the Corps and dredged.

The Corps may require proof of authorization. Maintenance dredging typically refers to the routine removal of accumulated sediment from channel beds to maintain the design depths of navigation channels, harbors, marinas, boat launches and port facilities. Routine maintenance dredging is conducted regularly for navigational purposes (typically at least once every ten years) and does not include any expansion of the previously dredged area or depth. The Corps may review a maintenance dredging activity as new dredging if sufficient time has elapsed to allow for the colonization of SAS, shellfish, etc. The main characteristics of maintenance dredging projects are variable quantities of material; soft, uncompacted soil; contaminant content possible; thin layers of material; occurring in navigation channels and harbors; repetitive activity

New Dredging: Dredging of an area or to a depth that has never been authorized by the Corps or dredged.

Dredged material & discharge of dredged material: These are defined at 323.2(c) and (d). The term dredged material means material that is excavated or dredged from waters of the U.S.

Essential Fish Habitat (EFH): This is broadly defined to include those waters and substrate necessary to fish for spawning, breeding, feeding, or growth to maturity.

Fill material & discharge of fill material: These are defined at 323.2(e) and (f). The term fill material is defined as material placed in waters of the U.S. where the material has the effect of either replacing any portion of a water of the U.S. with dry land or changing the bottom elevation of any portion of a water of the U.S.

Fill area: Fill area includes all temporary and permanent fill (including mats), and regulated discharges associated with excavation.

Federal navigation projects (FNPs): These areas are maintained by the Corps; authorized, constructed and maintained on the premise that they will be accessible and available to all on equal terms; and are comprised of Federal Anchorages, Federal Channels and Federal Turning Basins. The buffer zone is equal to three times the authorized depth of a FNP. More information on the following FNPs is provided at www.nae.usace.army.mil/missions/navigation.aspx >> Navigation Projects.

Flume: An open artificial water channel, in the form of a gravity chute that leads water from a diversion dam or weir completely aside a natural flow. A flume can be used to measure the rate of flow.

Frac out: During normal drilling operations, drilling fluid travels up the borehole into a pit. When the borehole becomes obstructed or the pressure becomes too great inside the borehole, the ground fractures and fluid escapes to the surface.

Habitat Connectivity Design: projects designed and constructed for consistency with natural stream dimensions, profiles, and dynamics, in accordance with the following technical references: U.S. Forest Service guide (Forest Service Stream-Simulation Working Group 2008), augmented by documents published by the states of Washington (Barnard et al. 2013), Vermont (Bates and Kirn 2009) and California (Love and Bates 2009).

Independent utility: A test to determine what constitutes a single and complete non-linear project in the Corps regulatory program. A project is considered to have independent utility if it would be constructed absent the construction of other projects in the project area. Portions of a multi-phase project that depend upon other phases of the project do not have independent utility. Phases of a project that would be constructed even if the other phases were not built can be considered as separate single and complete projects with independent utility.

Individual Permit: A Department of the Army authorization that is issued following a case-by-case evaluation of a specific structure or work in accordance with the procedures of 33 CFR 322, or a specific project involving the proposed discharge(s) in accordance with the procedures of 33 CFR 323, and in accordance with the procedures of 33 CFR 325 and a determination that the proposed discharge is in the public interest pursuant to 33 CFR 320.

Living Shoreline: Living shorelines stabilize banks and shores in coastal waters along shores with small fetch and gentle slopes that are subject to low-to mid-energy waves. A living shoreline has a footprint that is made up mostly of native material. It incorporates vegetation or other living, natural “soft” elements alone or in combination with some type of harder shoreline structure (e.g., oyster or mussel reefs or rock sills) for added protection and stability. Living shorelines shall maintain the natural continuity of the land-water interface, and retain or enhance shoreline ecological processes. Living shorelines must have a substantial biological component, either tidal or lacustrine fringe wetlands or oyster or mussel reef structures.

Maintenance:

a. The repair, rehabilitation, or replacement of any previously authorized, currently serviceable structure or fill, or of any currently serviceable structure or fill authorized by 33 CFR 330.3 – “Activities occurring before certain dates,” provided that the structure or fill is not to be put to uses differing from those uses specified or contemplated for it in the original permit or the most recently authorized modification.

- Minor deviations in the structure’s configuration or filled area, including those due to changes in materials, construction techniques, or current construction codes or safety standards that are necessary to make repair, rehabilitation, or replacement are authorized.
- Currently serviceable means useable as is or with some maintenance, but not so degraded as to essentially require reconstruction.
- No seaward expansion for bulkheads or any other fill activity is considered SV maintenance.
- Only structures or fills that were previously authorized and are in compliance with the terms and condition of the original authorization can be maintained as a non-regulated activity under 33 CFR 323.4(a)(2), or in accordance with the SV or PCN thresholds in Section V.

b. The state’s maintenance provisions may differ from the Corps and may require reporting and written authorization from the state.

c. Contact the Corps to determine whether stream crossing replacements require a PCN.

d. Exempted Maintenance. In accordance with 33 CFR 323.4(a)(2), any discharge of dredged or fill material that may result from any of the following activities is not prohibited by or otherwise subject to regulation under Section 404 of the CWA: “Maintenance, including emergency reconstruction of recently damaged parts, of currently serviceable structures such as dikes, dams, levees, groins, riprap, breakwaters, causeways, bridge abutments or approaches, and transportation structures. Maintenance does not include any modification that changes the character, scope, or size of the original fill design.”

The following definition is also applicable:

Minor deviations: Deviations in the structure's configuration or filled area, including those due to changes in materials, construction techniques, or current construction codes or safety standards, which are necessary to make repair, rehabilitation, or replacement are permitted, provided the adverse environmental effects resulting from such repair, rehabilitation, or replacement are minimal.

Marina reconfiguration zone: A Corps-authorized area in which permittees may rearrange pile-supported structures and floats without additional authorizations. A reconfiguration zone does not grant exclusive privileges to an area or an increase in structure or float area.

Natural Rocky Habitats: Natural rocky habitats are intertidal and subtidal substrates composed of pebble-gravel, cobble, boulder, or rock ledge and outcrops. Manufactured stone (e.g. cut or engineered rip-rap) is not considered a natural rocky habitat. Natural rocky habitats are either found as pavement (consolidated pebble-gravel, cobble, or boulder areas) or as a mixture with fines (i.e. clay and sand) and other substrates.

Navigable waters of the U.S.: See Waters of the U.S. below.

Overall project: See "single and complete linear project" below.

Practicable: Available and capable of being done after taking into consideration cost, existing technology, and logistics in light of overall project purposes.

Permanent impacts: Permanent impacts means waters of the U.S. that are permanently affected by filling, flooding, excavation, or drainage because of the regulated activity. Permanent impacts include permanent discharges of dredged or fill material that change an aquatic area to dry land, increase the bottom elevation of a waterbody, or change the use of a waterbody.

Pre-construction notification (PCN): A request submitted by a prospective permittee to the Corps for confirmation that a particular activity is authorized by this GP. The request may be a permit application, letter, or similar document that includes information about the proposed work and its anticipated environmental effects. Pre-construction notification may be required by the terms and conditions of these GPs. A PCN may be voluntarily submitted in cases where PCN is not required and the project proponent wants confirmation that the activity is authorized under this GP.

Re-establishment: The manipulation of the physical, chemical, or biological characteristics of a site with the goal of returning natural/ historic functions to a former aquatic resource. Re-establishment results in rebuilding a former aquatic resource and results in again in aquatic resource area and functions.

Rehabilitation: The manipulation of the physical, chemical, or biological characteristics of a site with the goal of repairing natural/historic functions to a degraded aquatic resource. Rehabilitation results in a gain in aquatic resource function, but does not result in a gain in aquatic resource area. Restoration: The manipulation of the physical, chemical, or biological characteristics of a site with the goal of returning natural/historic functions to a former or degraded aquatic resource. For the purpose of tracking net gains in aquatic resource area, restoration is divided into two categories: re-establishment and rehabilitation.

Restoration: The manipulation of the physical, chemical, or biological characteristics of a site with the goal of returning natural/historic functions to a former or degraded aquatic resource. For the purpose of tracking net gains in aquatic resource area, restoration is divided into two categories: re-establishment and rehabilitation.

Riffle and pool complexes: Riffle and pool complexes are special aquatic sites under the 404(b)(1) Guidelines. Riffle and pool complexes sometimes characterize steep gradient sections of streams. Such stream sections are recognizable by their hydraulic characteristics. The rapid movement of water over a coarse substrate in riffles results in a rough flow, a turbulent surface, and high dissolved oxygen levels in the water. Pools are deeper areas associated with riffles. A slower stream velocity, a streaming flow, a smooth surface, and a finer substrate characterize pools.

Secondary effects: See “Direct, secondary, and cumulative effects.”

Shellfish Areas: Areas that currently support molluscan shellfish. Information regarding these locations can be obtained from the State of Maine GeoLibrary Data Catalog at: www.maine.gov/geolib/catalog.html

Shellfish seeding: The placement of shellfish seed and/or suitable substrate to increase shellfish production. Shellfish seed consists of immature individual shellfish or individual shellfish attached to shells or shell fragments (i.e., spat on shell). Suitable substrate may consist of shellfish shells, shell fragments, or other appropriate materials placed into waters for shellfish habitat.

Single and complete linear project: A linear project is a project constructed for the purpose of getting people, goods, or services from a point of origin to a terminal point, which often involves multiple crossings of one or more waterbodies at separate and distant locations. The term “single and complete project” is defined as that portion of the total linear project proposed or accomplished by one owner/developer or partnership or other association of owners/developers that includes all crossings of a single water of the U.S. (i.e., a single waterbody) at a specific location. For linear projects crossing a single or multiple waterbodies several times at separate and distant locations, each crossing is considered a single and complete project for the purposes of this GP. However, individual channels in a braided stream or river, or individual arms of a large, irregularly shaped wetland or lake, etc., are not separate waterbodies, and crossings of such features cannot be considered separately. The overall project, for purposes of this GP, includes all regulated activities that are reasonably related and necessary to accomplish the project purpose.

Single and complete non-linear project: For non-linear projects, the term “single and complete project” is defined at 33 CFR 330.2(i) as the total project proposed or accomplished by one owner/developer or partnership or other association of owners/developers. For non-linear projects, the single and complete project shall have independent utility (see definition).

Special aquatic sites (SAS): These are defined at 40 CFR 230 Subpart E. They include sanctuaries and refuges, wetlands, mud flats, vegetated shallows (submerged aquatic vegetation, SAV), coral reefs, and riffle and pool complexes.

Stream: The term “stream” in the document means rivers, streams, brooks, etc.

Stream bed: The substrate of the stream channel between the ordinary high water marks. The substrate may be bedrock or inorganic particles that range in size from clay to boulders. Wetlands contiguous to the stream bed, but outside of the ordinary high water marks, are not considered part of the stream bed.

Stream channelization: The manipulation of a stream’s course, condition, capacity, or location that causes more than minimal interruption of normal stream processes. A channelized stream remains a water of the United States.

Stream Simulation: A method for designing and building road-stream crossings intended to permit free and unrestricted movements of any aquatic species. Reference:
<https://www.nae.usace.army.mil/Missions/Regulatory/Stream-and-River-Continuity/>

Stream Smart Design: projects designed to allow the stream to act like a stream by passing fish and wildlife as well as the higher flows that come with large infrequent storms while protecting the stability of the road and public safety. Stream Smart Design follows the “Four S’s”: The culvert must SPAN the stream, allowing for passage of aquatic and terrestrial wildlife. The culvert has to be SET at the right elevation. The SLOPE of the culvert must match the stream. There must be SUBSTRATE (natural sediment) in the crossing. Reference:
www1.maine.gov/mdot/publications/docs/brochures/pocket_guide_stream_smart_web.pdf

Temporary impacts: Temporary impacts include waters of the U.S. that are temporarily filled, flooded, excavated, drained or mechanically cleared because of the regulated activity.

Temporal loss: The time lag between the loss of aquatic resource functions caused by the permitted impacts and the replacement of aquatic resource functions at the compensatory mitigation site(s) (33 CFR 332.2).

Utility line: Any pipe or pipeline for the transportation of any gaseous, liquid, liquescent, or slurry substance, for any purpose, and any cable, line, or wire for the transmission for any purpose of electrical energy, telephone, and telegraph messages, and radio and television communication. The term ‘utility line’ does not include activities that drain a water of the U.S., such as drainage tile or French drains, but it does apply to pipes conveying drainage from another area.

Vegetated shallows/Submerged Aquatic Vegetation (SAV): Permanently inundated areas that under normal circumstances support communities of rooted aquatic vegetation, such as eelgrass in marine systems as well as a number of freshwater species in rivers and lakes. Note: Eelgrass surveys should be conducted between May and October unless otherwise directed.

Vernal pools (VPs): The State of Maine, Department of Environmental Protection has specific protections for VPs. For the purposes of these GPs, VPs are depressional wetland basins that typically go dry in most years and may contain inlets or outlets, typically of intermittent flow. Vernal pools range in both size and depth depending upon landscape position and parent material(s). In most years, VPs support one or more of the following obligate indicator species: wood frogs (*Rana sylvatica*), spotted salamanders (*Ambystoma maculatum*), blue-spotted salamanders (*Ambystoma laterale*), and fairy shrimp (*Eubranchipus* sp.). However, they should preclude sustainable populations of predatory fish.

Water dependency: activity requiring access or proximity to or siting within a special aquatic site (SAS) to fulfill its basic project purpose.

Water diversions: Water diversions are activities such as bypass pumping (e.g., “dam and pump”) or water withdrawals. Temporary flume pipes, culverts or cofferdams where normal flows are maintained within the stream boundary’s confines aren’t water diversions. “Normal flows” are defined as no change in flow from pre-project conditions.

Weir: A barrier across a river designed to alter the flow characteristics. In most cases, weirs take the form of a barrier, smaller than most conventional dams, across a river that causes water to pool behind the structure (not unlike a dam) and allows water to flow over the top. Weirs are commonly used to alter the flow regime of the river, prevent flooding, measure discharge and help render a river navigable.

Waters of the United States (U.S.)

Waters of the U.S.: The term waters of the U.S. and all other terms relating to the geographic scope of jurisdiction are defined at 33 CFR 328. Also see Section 502(7) of the Federal CWA [33 USC 1352(7)]. Waters of the U.S. include jurisdictional wetlands. Not all waters and wetlands are jurisdictional. Contact the Corps with any questions regarding jurisdiction.

Navigable waters: Refer to 33 CFR 329. These waters include the following federally-designated navigable waters in New England. This list represents only those waterbodies for which affirmative determinations have been made; absence from this list shall not be taken as an indication that the waterbody is not navigable: In Maine, navigable waters are those waters that are subject to the ebb and flow of the tide in addition to the non-tidal portions of the following federally-designated waters in Maine (the Kennebec River to Moosehead Lake, the Penobscot River to the confluence of the East and West Branch at Medway and, Lake Umbagog within the State of Maine).

Non-tidal wetland: A non-tidal wetland is a wetland that is not subject to the ebb and flow of tidal waters. Non-tidal wetlands contiguous to tidal waters are located landward of the high tide line (i.e., spring high tide line).

Tidal wetland: A tidal wetland is a jurisdictional wetland that is inundated by tidal waters. Tidal waters rise and fall in a predictable and measurable rhythm or cycle due to the gravitational pulls of the moon and sun. Tidal waters end where the rise and fall of the water surface can no longer be practically measured in a predictable rhythm due to masking by other waters, wind, or other effects. Tidal wetlands are located channelward of the high tideline.



REPLY TO
ATTENTION OF

DEPARTMENT OF THE ARMY
NEW ENGLAND DISTRICT, CORPS OF ENGINEERS
696 VIRGINIA ROAD
CONCORD, MASSACHUSETTS 01742-2751

**ENVIRONMENTAL OFFICE
MAINE DEPT. OF TRANSPORTATION
16 STATE HOUSE STATION
AUGUSTA, MAINE 04333**

CORPS PERMIT # NAE-2021-02552
CORPS GPs 22
STATE ID# NRPA

DESCRIPTION OF WORK:

Place permanent and temporary fill below the ordinary high water mark of an unnamed stream and in adjacent freshwater wetlands at Union, Maine in order to rehabilitate an existing deteriorated culvert beneath Route 17 by installing an invert liner. This work will result in approximately 859 s.f. of permanent and 657 s.f. of temporary stream bed impact, and 869 s.f. of temporary wetland impact and is shown on the attached plans entitled "Union, Route 17, WIN 24237, Culvert Rehabilitation" in one sheet undated, "ROUTE 17 UNION, Knox County" in one sheet undated and "UNION, ROUTE 17" in five sheets dated "1/21".
DOT WIN: 24237.00

See Special and General Conditions attached.

LAT/LONG COORDINATES: 44.216240° °N -69.272370° °W **USGS QUAD:** UNION, ME

I. CORPS DETERMINATION:

Based on our review of the information you provided, we have determined that your project will have only minimal individual and cumulative impacts on waters and wetlands of the United States. **Your work is therefore authorized by the U.S. Army Corps of Engineers under the Federal Permit, the Maine General Permits (GPs) which can be found at: <https://www.nae.usace.army.mil/Missions/Regulatory/State-General-Permits/Maine-General-Permit/>** Accordingly, we do not plan to take any further action on this project.

You must perform the activity authorized herein in compliance with all the terms and conditions of the GP [including any attached Additional Conditions and any conditions placed on the State 401 Water Quality Certification including any required mitigation]. Please review the enclosed GPs, including the GPs conditions beginning on page 5, to familiarize yourself with its contents. You are responsible for complying with all of the GPs requirements; therefore you should be certain that whoever does the work fully understands all of the conditions. You may wish to discuss the conditions of this authorization with your contractor to ensure the contractor can accomplish the work in a manner that conforms to all requirements.

If you change the plans or construction methods for work within our jurisdiction, please contact us immediately to discuss modification of this authorization. This office must approve any changes before you undertake them.

Condition 45 of the GPs (page 19) provides one year for completion of work that has commenced or is under contract to commence prior to the expiration of the GPs on October 14, 2025. You will need to apply for reauthorization for any work within Corps jurisdiction that is not completed by October 14, 2026.

This authorization presumes the work shown on your plans noted above is in waters of the U.S. Should you desire to appeal our jurisdiction, please submit a request for an approved jurisdictional determination in writing to the undersigned.

No work may be started unless and until all other required local, State and Federal licenses and permits have been obtained. **This includes but is not limited to a Flood Hazard Development Permit issued by the town if necessary.**

II. STATE ACTIONS: PENDING [X], ISSUED [], DENIED [] DATE _____

APPLICATION TYPE: PBR: X, TIER 1: _____, TIER 2: _____, TIER 3: _____, LURC: _____, DMR LEASE: _____, NA: _____

III. FEDERAL ACTIONS:

JOINT PROCESSING MEETING: 10/6/21 LEVEL OF REVIEW: SELF-VERIFICATION: _____ PRE-CONSTRUCTION NOTIFICATION: X

AUTHORITY (Based on a review of plans and/or State/Federal applications): SEC 10 _____, 404 X 10/404 _____, 103 _____

EXCLUSIONS: The exclusionary criteria identified in the general permit do not apply to this project.

FEDERAL RESOURCE AGENCY OBJECTIONS: EPA NO, USF&WS NO, NMFS NO

If you have any questions on this matter, please contact my staff at 978-318-8676 at our Augusta, Maine Project Office. In order for us to better serve you, we would appreciate your completing our Customer Service Survey located at: http://corpsmapu.usace.army.mil/cm_apex/f?p=136:4:0

Digitally signed by
CLEMENT,JAY.LANGDON.1006350980
Date: 2021.11.15 14:46:07 -05'00'

**JAY L. CLEMENT
SENIOR PROJECT MANAGER
MAINE PROJECT OFFICE**

Digitally signed by
CLEMENT,JAY.LANGDON.1006350
980
Date: 2021.11.15 14:49:43 -05'00'

**FOR FRANK J. DEL GIUDICE
CHIEF, PERMITS & ENFORCEMENT BRANCH
REGULATORY DIVISION**



PLEASE NOTE THE FOLLOWING GENERAL AND SPECIAL CONDITIONS FOR
DEPARTMENT OF THE ARMY
MAINE GENERAL PERMITS 22
PERMIT NO. NAE-2021-02552

GENERAL CONDITIONS

3. Other Permits. Permittees shall obtain other Federal, State, or local authorizations as required by law. Permittees are responsible for applying for and obtaining all required State of Maine or local approvals including a Flood Hazard Development Permit issued by the town/city. Work that is not regulated by the State of Maine, but is subject to Corps jurisdiction, may still be eligible for authorization under these GPs.

23. Soil Erosion, Sediment, and Turbidity Controls.

a. Adequate sedimentation and erosion control management measures, practices and devices, such as phased construction, installation of sediment control barriers (i.e. silt fence, vegetated filter strips, geotextile silt fences, erosion control mixes, hay bales or other devices) downhill of all exposed areas, retention of existing vegetated buffers, application of temporary mulching during construction, and permanent seeding and stabilization shall be installed and properly maintained to reduce erosion and retain sediment on-site during and after construction. They shall be capable of preventing erosion; of collecting sediment, suspended and floating materials; and of filtering fine sediment.

b. Temporary sediment control barriers shall be removed upon completion of work, but not until all disturbed areas are permanently stabilized. The sediment collected by these sediment barriers shall be removed and placed at an upland location and stabilized to prevent its later erosion into a waterway or wetland.

c. All exposed soil and other fills shall be permanently stabilized at the earliest practicable date.

26. Temporary Fill.

a. Temporary fills, including but not limited to construction mats and corduroy roads shall be entirely removed as soon as they are no longer needed to construct the authorized work. Temporary fill shall be placed in its original location or disposed of at an upland site and suitably contained to prevent its subsequent erosion into waters of the U.S.

b. All temporary fill and disturbed soils shall be stabilized to prevent its eroding into waters of the U.S. where it is not authorized. Work shall include phased or staged development to ensure only areas under active development are exposed and to allow for stabilization practices as soon as practicable. Temporary fill shall be placed in a manner that will prevent it from being eroded by expected high flows.

c. Unconfined temporary fill authorized for discharge into waters of the U.S. shall consist of material that minimizes impacts to water quality (e.g. washed stone, stone, etc.).

d. Appropriate measures shall be taken to maintain normal downstream flows and minimize flooding to the maximum extent practicable when temporary structures, work, and discharges of dredged or fill material, including cofferdams, are necessary for construction activities, access fills, or dewatering of construction sites. Materials shall be placed in a location and manner that does not adversely impact surface or subsurface water flow into or out of the wetland. Temporary fill authorized for discharge into wetlands shall be placed on geotextile fabric or other appropriate material laid on the pre-construction wetland grade where practicable to minimize impacts and to facilitate restoration to the original grade. Construction mats are excluded from this requirement.

e. Construction debris and/or deteriorated materials shall not be placed or otherwise located in waters of the U.S.

33. Permit(s)/Authorization Letter On-Site. The permittee shall ensure that a copy of the terms and conditions of these GPs and any accompanying authorization letter with attached plans are at the site of the work authorized by these GPs whenever work is being performed and that all construction personnel performing work which may affect waters of the U.S. are fully aware of the accompanying terms and conditions. The entire permit authorization shall be made a part of any and all contracts and subcontracts for work that affects areas of Corps jurisdiction at the site of the work authorized by these GPs. This shall be achieved by including the entire permit authorization in the specifications for work. The term "entire permit authorization" means all terms and conditions of the GPs, the GPs, and the authorization letter (including its drawings, plans, appendices and other attachments) and subsequent permit modifications as applicable. If the authorization letter is issued after the construction specifications, but before receipt of bids or quotes, the entire permit authorization shall be included as an addendum to the specifications. If the authorization letter is issued after receipt of bids or quotes, the entire permit authorization shall be included in the contract or subcontract. Although the permittee may assign various aspects of the work to different contractors or subcontractors, all contractors and subcontractors shall be obligated by contract to comply with all environmental protection provisions contained within the entire GP authorization,

34. Inspections. The permittee shall allow the Corps to make periodic inspections at any time deemed necessary in order to ensure that the work is eligible for authorization under these GPs, is being, or has been performed in accordance with the terms and conditions of these GPs. To facilitate these inspections, the permittee shall complete and return to the Corps the Work-Start Notification Form and the Compliance Certification Form when either is provided with an authorization letter. **These forms are attached after the plans.**

SPECIAL CONDITIONS

1. In accordance with the FHWA/Maine DOT Biological Assessment dated April 23, 2021 and the U.S. Fish & Wildlife Service concurrence letter dated May 13, 2021, the permittee shall comply with all designated Avoidance and Minimization Measures (AMMs).



**US Army Corps
of Engineers**®
New England District

(Minimum Notice: Permittee must sign and return notification
within one month of the completion of work.)

COMPLIANCE CERTIFICATION FORM

Corps of Engineers Permit No: NAE-2021-02552

Name of Permittee: Maine Dept. of Transportation

Permit Issuance Date: _____

Please sign this certification and return it to the following address upon completion of the activity and any mitigation required by the permit. You must submit this after the mitigation is complete, but not the mitigation monitoring, which requires separate submittals.

```

*****
* MAIL TO: U.S. Army Corps of Engineers, New England District      *
*           Policy & Technical Support Branch                      *
*           Regulatory Division                                    *
*           696 Virginia Road                                     *
*           Concord, Massachusetts 01742-2751                    *
*****

```

Please note that your permitted activity is subject to a compliance inspection by an U.S. Army Corps of Engineers representative. If you fail to comply with this permit you are subject to permit suspension, modification, or revocation.

I hereby certify that the work authorized by the above referenced permit was completed in accordance with the terms and conditions of the above referenced permit, and any required mitigation was completed in accordance with the permit conditions.

Signature of Permittee

Date

Printed Name

Date of Work Completion

() _____
Telephone Number

() _____
Telephone Number

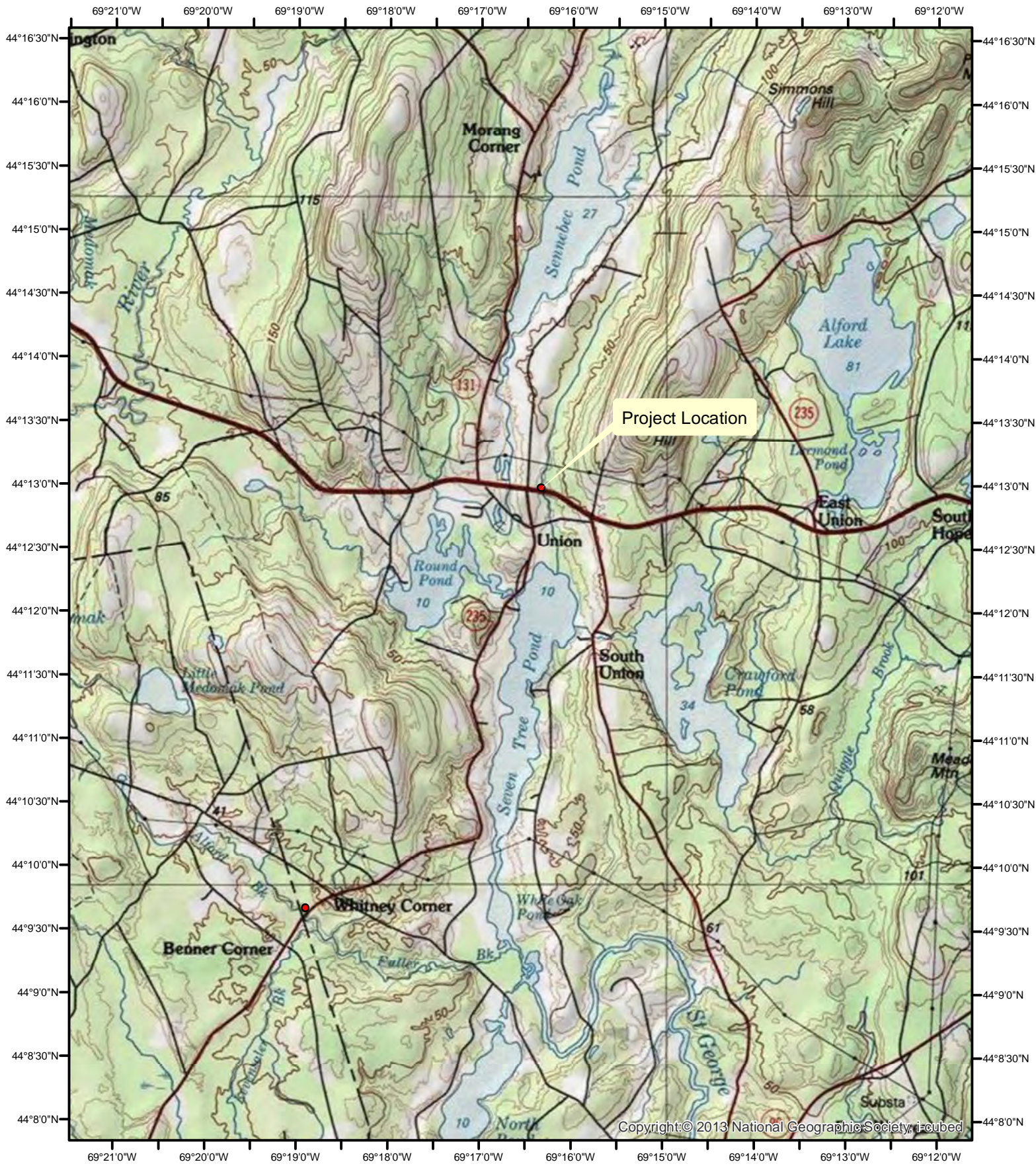

Union, Route 17, WIN 24237, Culvert Rehabilitation

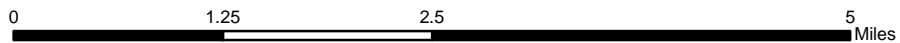

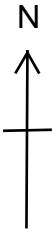

Approximate Cofferdam Location

Permanent Access Easement

60" CMP

13+00

14+00



110

110

110

110

Approximate Cofferdam Location

-  PERM WETLAND IMPACTS NA
-  PSS TEMP WETLAND IMPACTS ~869 s.f.
-  RUS TEMP IMPACTS ~657 s.f.
-  RUS PERM IMPACTS ~859 s.f.
-  PROPOSED

RUS line indicates delineated OHWM

STATE OF MAINE
DEPARTMENT OF TRANSPORTATION

ROUTE 17
Knox County

UNION

SHEET NUMBER

024237.00

PLANS

1

220

OF 1

STATE OF MAINE DEPARTMENT OF TRANSPORTATION

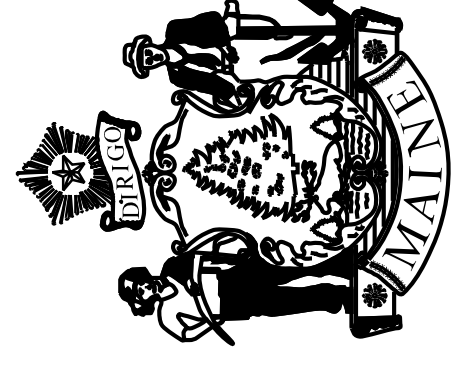

UNION KNOX COUNTY

ROUTE 17

STATE PROJECT NUMBER 24237.00

PROJECT LENGTH : 0.01 MILES
LARGE CULVERT NO. 46462

PLAN LEGEND	
Town, County, State	Existing Proposed
Property Lines	Existing Proposed
R/W Lines-Existing	Proposed Underdrain
R/W Lines-Proposed	Proposed Ditch
Culvert-Existing	Existing Ditch
Culvert Proposed	Utility Poles
Curbing	Fire Hydrants Existing Proposed
Type 1	Existing Water Line
Type 3	Existing San. Sewer
Type 5	Existing San. Sewer Manhole
Outline of Bodies of Water	Guardrail-Existing
Exposed Bedrock	Guardrail-Proposed
Buildings	Guardrail-Cable, Other
Trees	Centerline-Existing
Tree Line	Centerline-Proposed
Clearing Limit Line	Travelway-Existing
Railroad	Travelway-Proposed
Boring	Probe P-##X
Pavement Core	#.# = Depth
Test Pit	X = W (Weathered Rock)
	R (Refusal)
	NR (No Refusal)
	TP-XXX-##

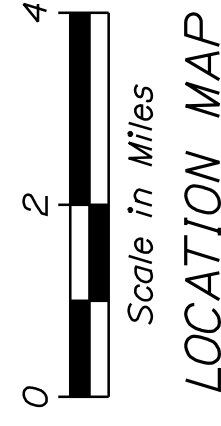
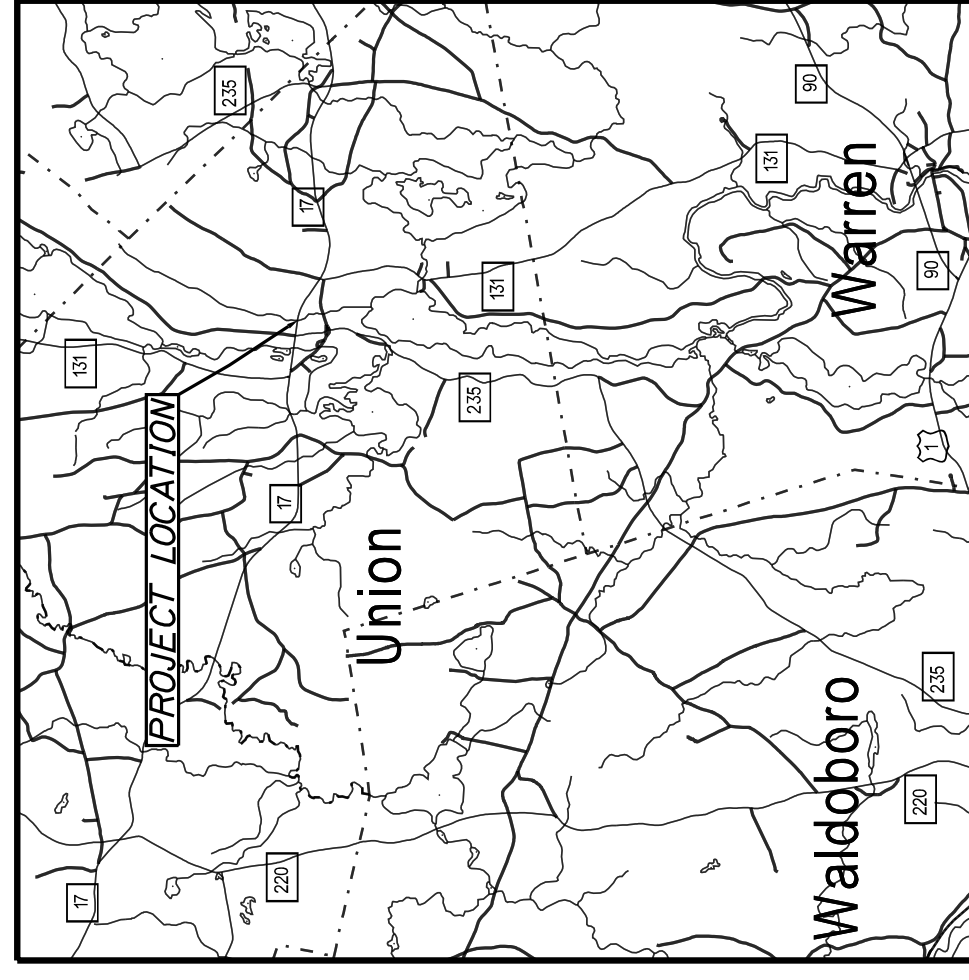

Scale in Miles
LOCATION MAP

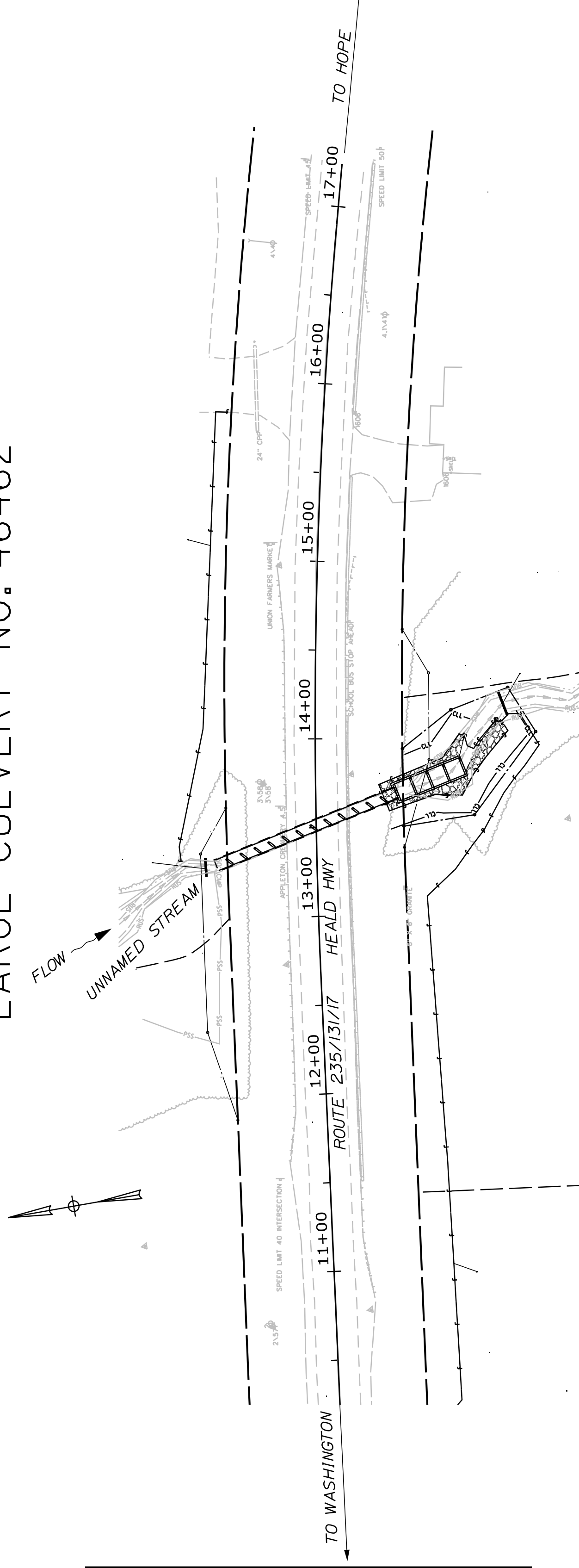

TRAFFIC DATA	
Current (2019) AADT	7500
Future (2039) AADT	8250
DHV - % of AADT	11%
Design Hour Volume	907
% Heavy Trucks (AADT)	6%
Directional Distribution (DHV)	61%
Design Speed (mph)	50
Functional Class	Minor Arterial
Corridor Priority	2

INDEX OF SHEETS	
Description	Sheet No.
Title Sheet	1
General Notes and Estimated Quantities	2
Special Details	3
Plan	4
Cross Section	5
Right of Way Map	6

**PERMITTING PLAN
JULY 19, 2021**

WIN 24237.00	
TYLIN INTERNATIONAL	IN THE TOWN OF UNION ON ROUTE 17, LOCATED 0.06 MILES EAST OF TOWN HOUSE ROAD
PROJECT LOCATION:	
PROGRAM AREA:	HIGHWAY PROGRAM
SCOPE OF WORK:	LARGE CULVERT REHABILITATION: INVERT LINING

UNION ROUTE 17 TITLE SHEET	SHEET NUMBER 1	OF 6
PROJECT INFORMATION PROGRAM HIGHWAY PROJECT MANAGER SHAWN DAVIS DESIGNER SHAWN DAVIS CONSULTANT T.Y. INE PROJECT RESIDENT CONTRACTOR PROJECT COMPLETION DATE	PROJECT INFORMATION SIGNATURE P.E. NUMBER DATE	STATE OF MAINE DEPARTMENT OF TRANSPORTATION APPROVED COMMISSIONER CHIEF ENGINEER

PROJ. MANAGER S. DAVIS	BY S. DAVIS	DATE
DESIGN-DETAILS D. BURHANS	1/21	
CHECKED-REVIEWED S. DAVIS		
DESIGN-DETAILS S. DAVIS		
DESIGN-DETAILS S. DAVIS		
REVISIONS 1		
REVISIONS 2		
REVISIONS 3		
REVISIONS 4		
FIELD CHANGES		

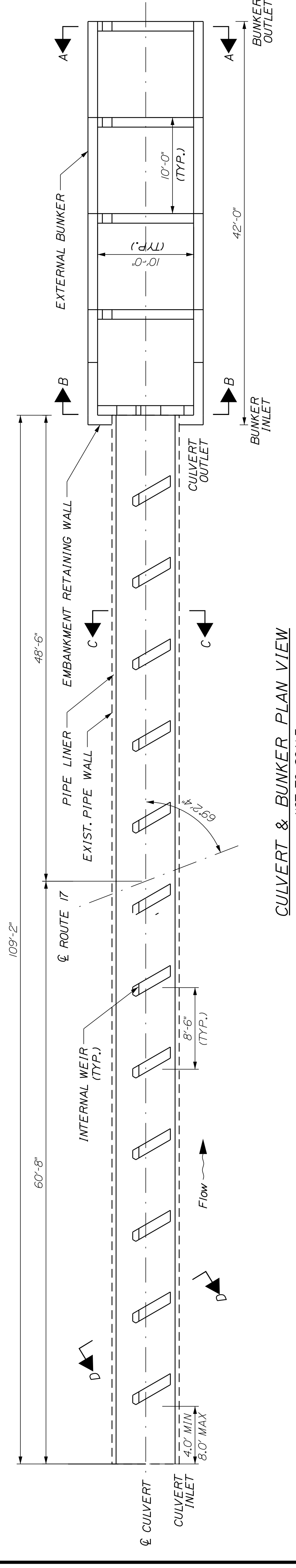

CULVERT & BUNKER PLAN VIEW
NOT TO SCALE

- NOTES:
1. EXISTING PIPE VERTICAL INNER DIAMETER = 90"
 2. EXISTING PIPE HORIZONTAL INNER DIAMETER = 84"
 3. INVERT SHALL EXTEND VERTICALLY UP CULVERT WALLS AS REQUIRED TO ADEQUATELY PROVIDE CONNECTION BETWEEN THE INVERT LINE AND THE CULVERT. THIS IS ESTIMATED AT 2.5'-3" BASED UPON FIELD EXAMINATION.

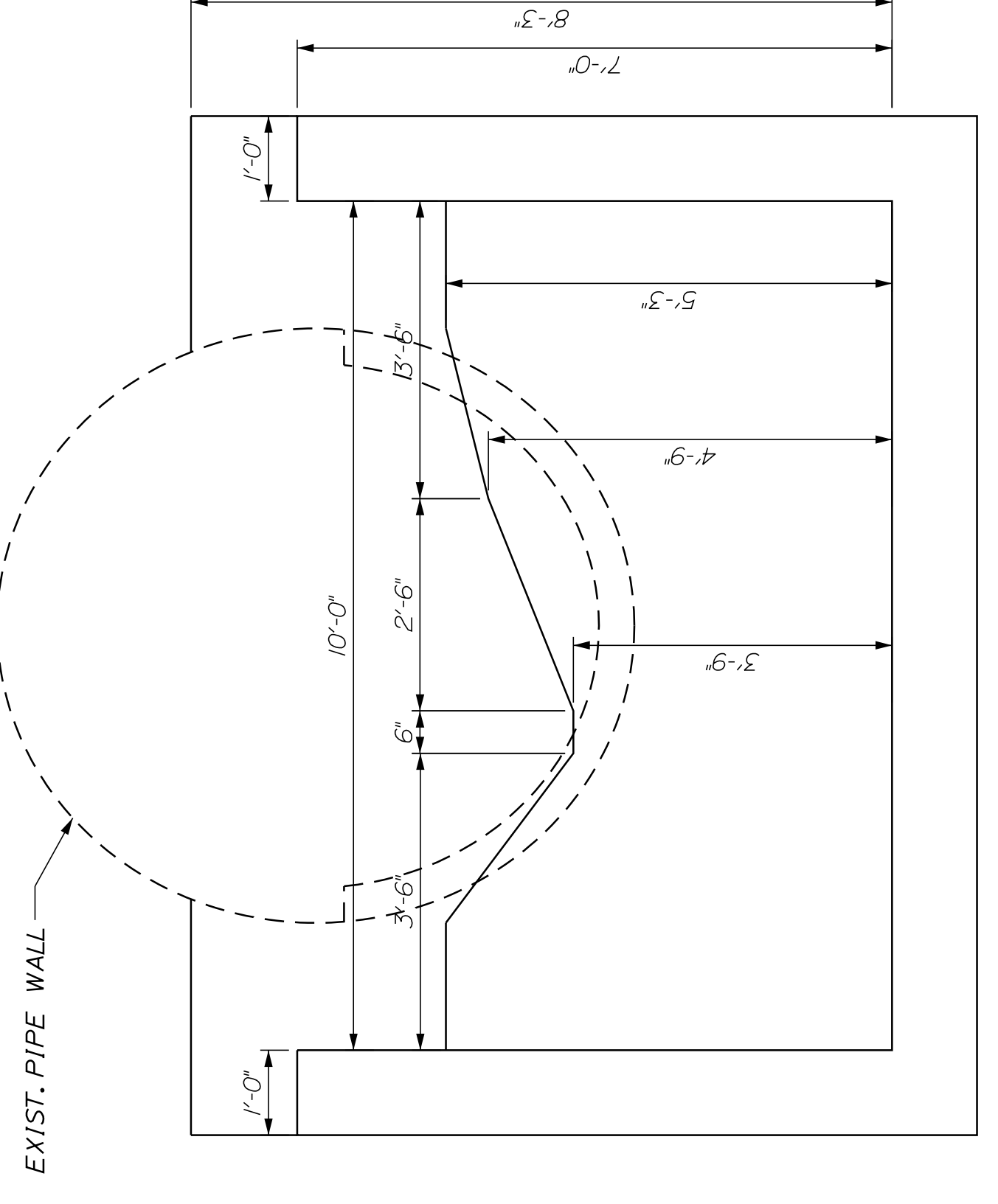

SECTION B-B
1ST EXTERNAL BUNKER WEIR
NOT TO SCALE

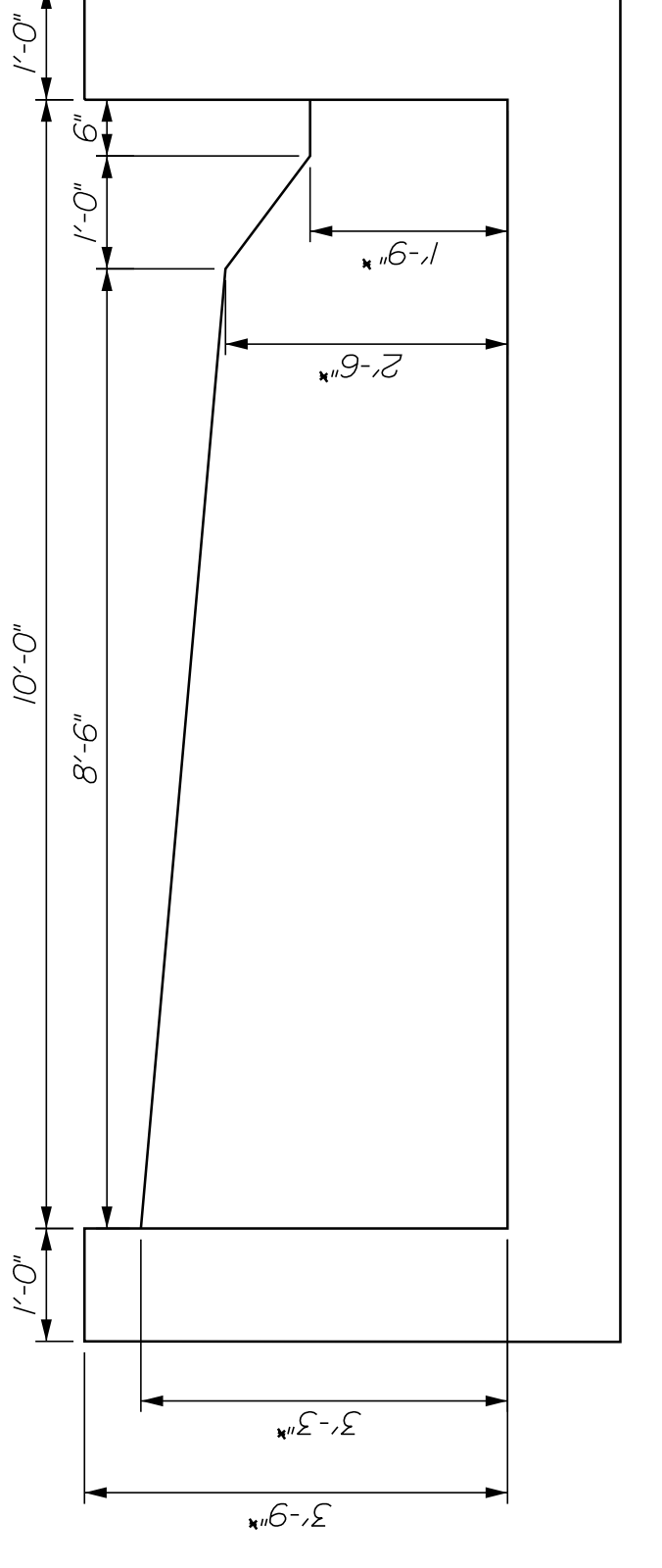

SECTION A-A
TYPICAL EXTERNAL BUNKER WEIR
NOT TO SCALE

* PROCEEDING FROM BUNKER OUTLET TOWARDS CULVERT OUTLET INCREASE VERTICAL DIMENSION BY 6" FOR EACH WEIR. SEE CROSS SECTION SHEET (SHEET 5) FOR ADDITIONAL DETAILS.

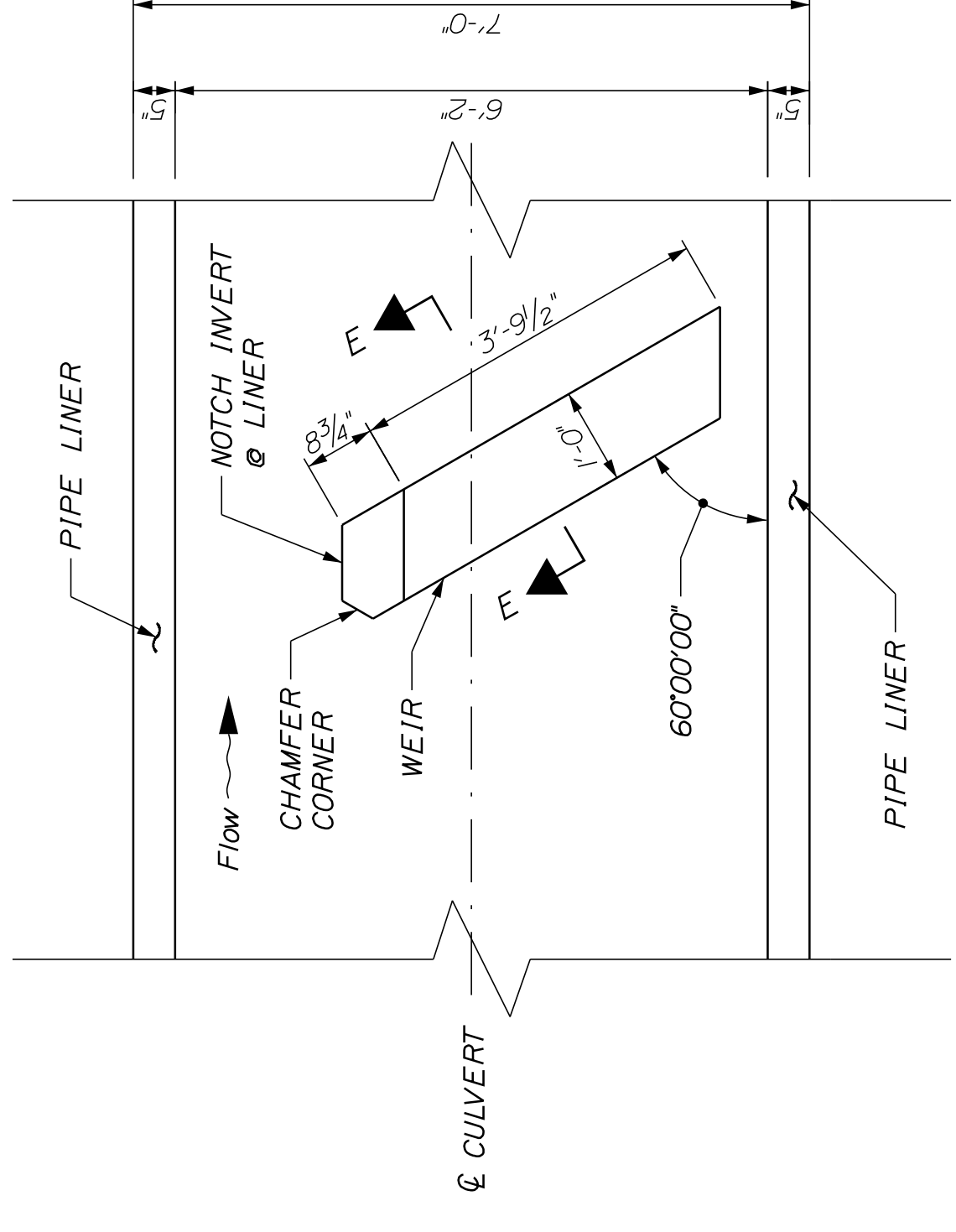

INTERNAL WEIR
PLAN VIEW
NOT TO SCALE

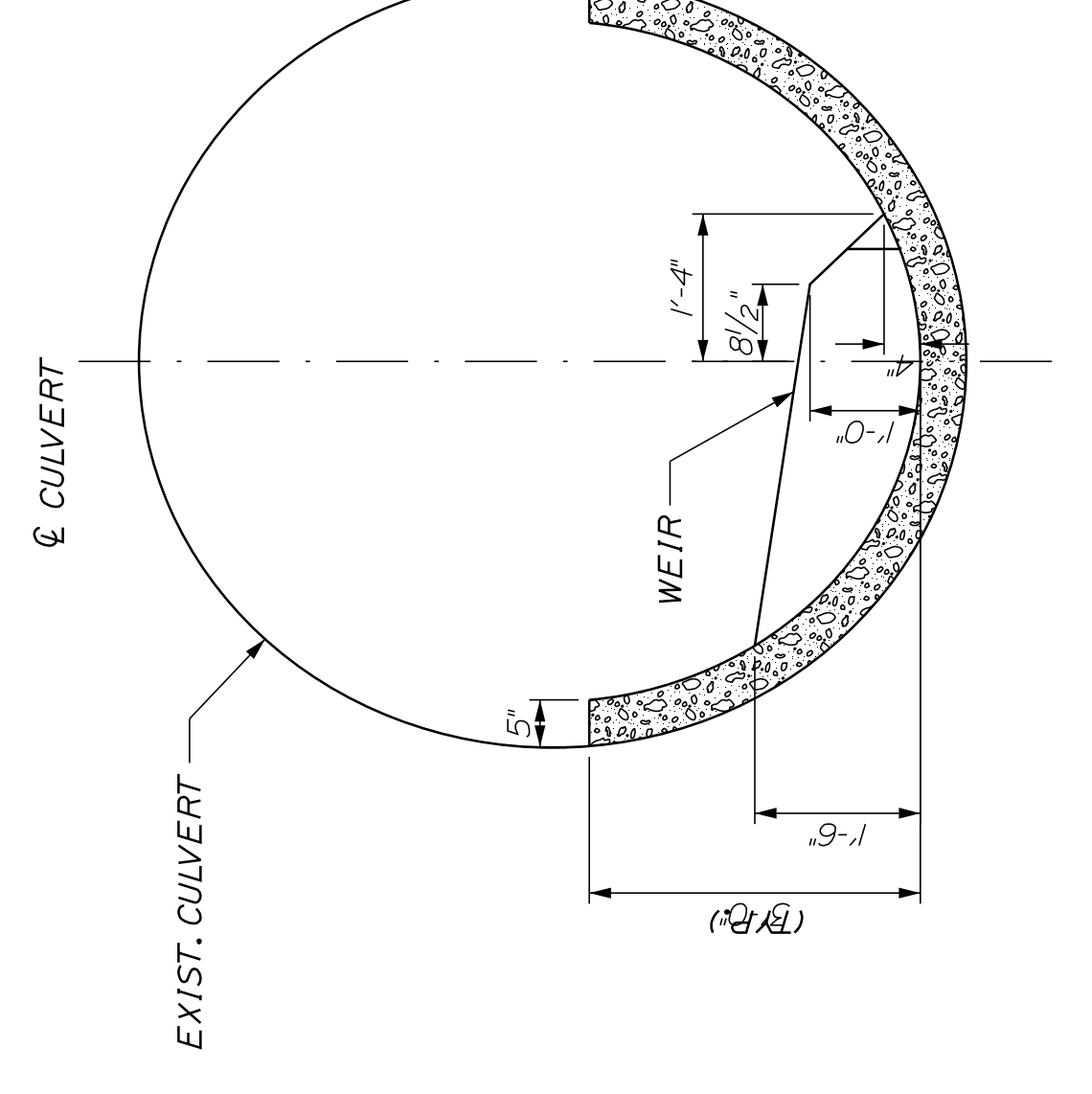

SECTION C-C
PERPENDICULAR TO CULVERT
NOT TO SCALE

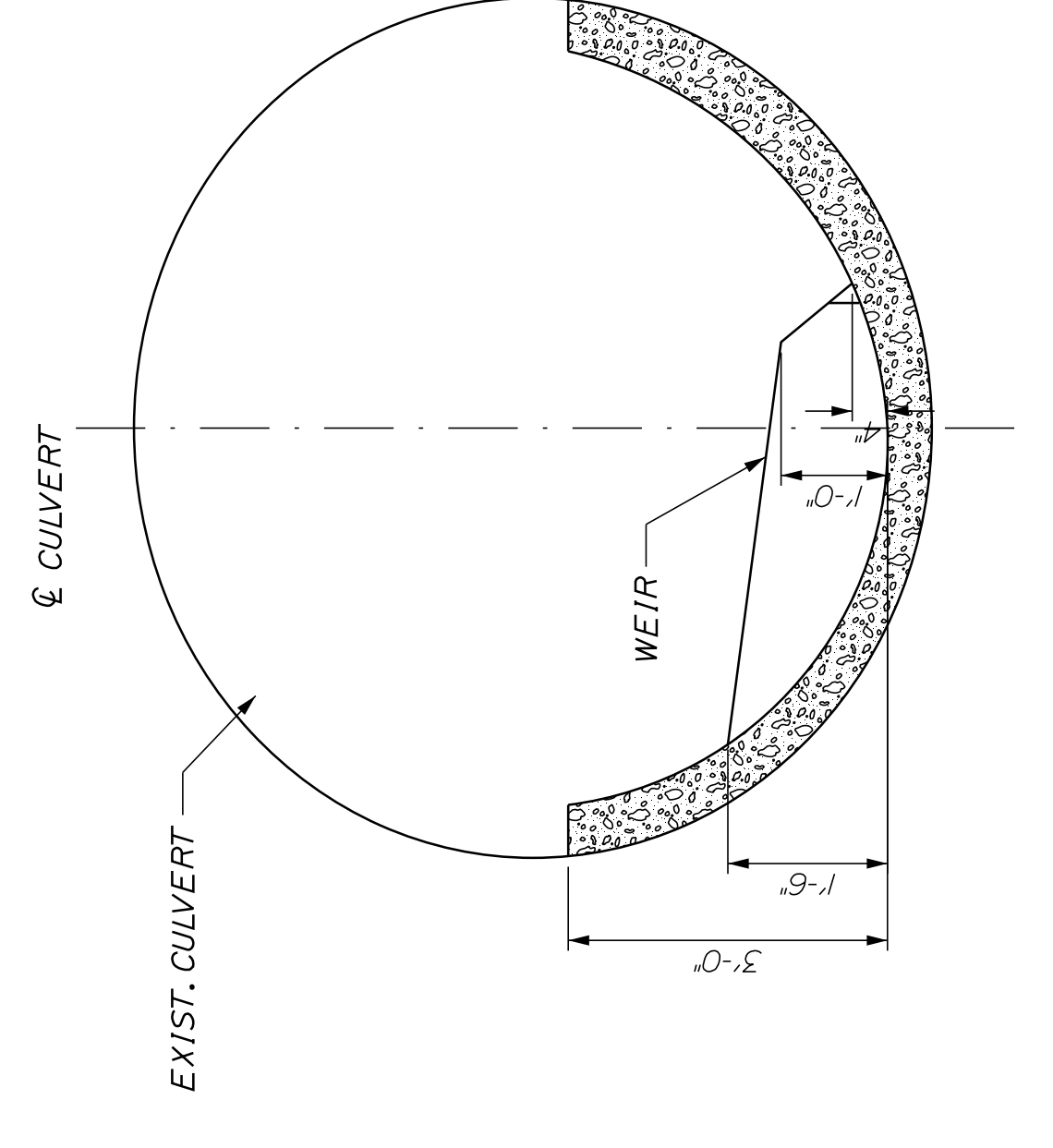

SECTION D-D
PERPENDICULAR TO WEIR
NOT TO SCALE

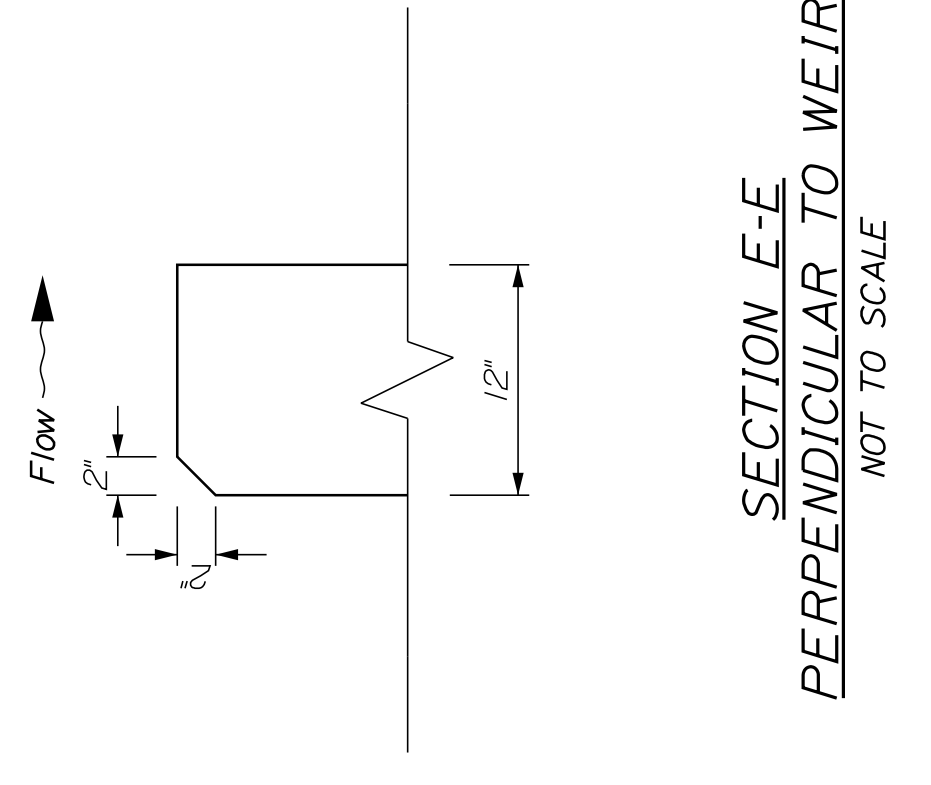

SECTION E-E
PERPENDICULAR TO WEIR
NOT TO SCALE

UNION
ROUTE 17
GENERAL PLAN

STATE OF MAINE
DEPARTMENT OF TRANSPORTATION
24237.00
WIN
24237.00
CULVERT NO. 46462

PROJ. MANAGER	S. DAVIS	BY	DATE
CHECKED-REVIEWED	D. BURHANS	1/21	
DESIGN-DETAILS	S. DAVIS	1/21	
DESIGN-DETAILED			
REVISIONS 1			
REVISIONS 2			
REVISIONS 3			
REVISIONS 4			
FIELD CHANGES			

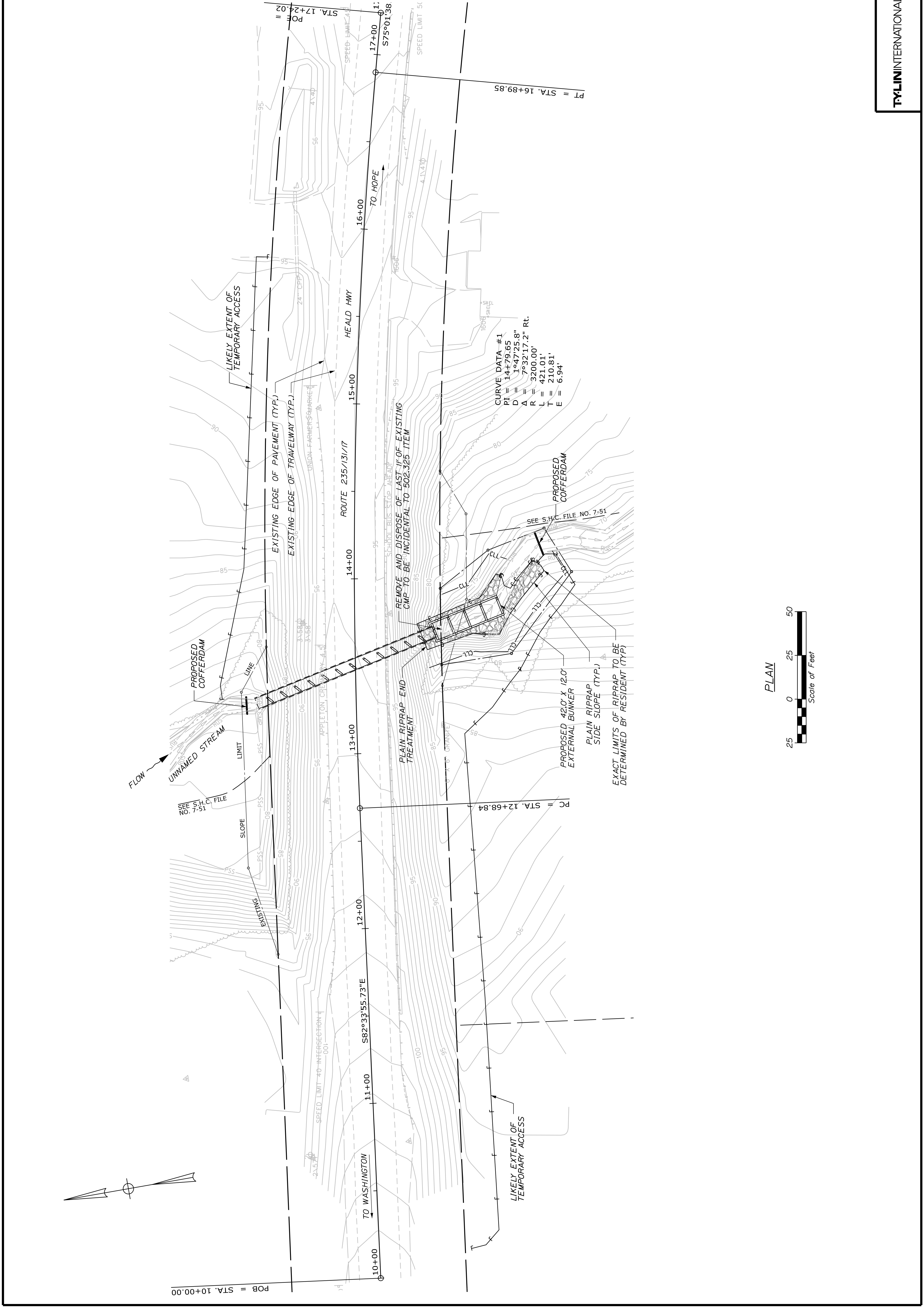

**DEPARTMENT OF ENVIRONMENTAL PROTECTION
PERMIT BY RULE NOTIFICATION FORM**

(For use with DEP Regulation, Natural Resources Protection Act - Permit by Rule Standards, Chapter 305)

APPLICANT INFORMATION (Owner)				AGENT INFORMATION (If Applying on Behalf of Owner)			
Name:	MaineDOT- Environmental Office			Name:			
Mailing Address:	16 State House Station			Mailing Address:			
Mailing Address:				Mailing Address:			
Town/State/Zip:	Augusta, ME 04333			Town/State/Zip:			
Daytime Phone #:	(207) 590-4632	Ext:		Daytime Phone #:		Ext:	
Email Address:	audie.arbo@maine.gov			Email Address:			
PROJECT INFORMATION							
Part of a larger project? (check 1):	<input type="checkbox"/> Yes <input checked="" type="checkbox"/> No	After the Fact? (check 1):	<input type="checkbox"/> Yes <input checked="" type="checkbox"/> No	Project involves work below mean low water? (check 1):	<input checked="" type="checkbox"/> Yes <input type="checkbox"/> No	Name of waterbody:	unnamed stream
Project Town:	Union		Town Email Address:			Map and Lot Number:	
Brief Project Description:	WIN# 24237.00 MaineDOT proposes to rehabilitate the poor condition culvert through the addition of an invert liner. The invert will extend vertically approximately 2.5 to 3 ft up the culvert walls to provide a good connection between the liner and the culvert. Internal weirs spaced approximately 10.5 ft apart will be installed to facilitate fish passage						
Project Location & Brief Directions to Site:	Large culvert (LC #46462), located on Route 17 (Lakeview Drive) 0.06 miles west of the intersection with Town House Road in Union, Maine.						

PERMIT BY RULE (PBR) SECTIONS (Check at least one): I am filing notice of my intent to carry out work that meets the requirements for Permit-by-Rule (PBR) under DEP Rules, [Chapter 305](#). I and my agent(s), if any, have read and will comply with all of the standards in the Sections checked below.

- | | | |
|---|---|---|
| <input type="checkbox"/> Sec. (2) Act. Adj. to Prot. Natural Res. | <input type="checkbox"/> Sec. (9) Utility Crossing | <input type="checkbox"/> Sec. (16) Coastal Sand Dune Projects |
| <input type="checkbox"/> Sec. (3) Intake Pipes | <input type="checkbox"/> Sec. (10) Stream Crossing | <input type="checkbox"/> Sec. (17) Transfer/Permit Extension |
| <input type="checkbox"/> Sec. (4) Replacement of Structures | <input checked="" type="checkbox"/> Sec. (11) State Transportation Facilities | <input type="checkbox"/> Sec. (18) Maintenance Dredging |
| <input type="checkbox"/> Sec. (6) Movement of Rocks or Veg. | <input type="checkbox"/> Sec. (12) Restoration of Natural Areas | <input type="checkbox"/> Sec. (19) Act. Near SVP Habitat |
| <input type="checkbox"/> Sec. (7) Outfall Pipes | <input type="checkbox"/> Sec. (13) F&W Creat./Water Qual. Improv. | <input type="checkbox"/> Sec. (20) Act. Near Waterfowl/Bird Habitat |
| <input type="checkbox"/> Sec. (8) Shoreline Stabilization | <input type="checkbox"/> Sec. (15) Public Boat Ramps | |

NOTE: Municipal permits also may be required. Contact your local code enforcement office for information. Federal permits may be required for stream crossings and for projects involving wetland fill. Contact the Army Corps of Engineers at the Maine Project Office for information.

NOTIFICATION FORMS CANNOT BE ACCEPTED WITHOUT THE NECESSARY ATTACHMENTS AND FEE

- Attach** all required submissions for the PBR Section(s) checked above. The required submissions for each PBR Section are outlined in Chapter 305 and may differ depending on the Section you are submitting under.
- Attach** a location map that clearly identifies the site (U.S.G.S. topo map, Maine Atlas & Gazetteer, or similar).
- Attach** Proof of Legal Name if applicant is a corporation, LLC, or other legal entity. Provide a copy of Secretary of State's registration information (available at <http://icrs.informe.org/nei-sos-icrs/ICRS?MainPage=x>). Individuals and municipalities are not required to provide any proof of identity.

FEE: Pay by credit card at the [Payment Portal](#). The Permit-by-Rule fee may be found here <https://www.maine.gov/dep/feeschedule.pdf> and is currently \$266.

INTERNAL BILLING PLEASE

- Attach** payment confirmation from the Payment Portal when filing this notification form.

Signature & Certification:

- I authorize staff of the Departments of Environmental Protection, Inland Fisheries & Wildlife, and Marine Resources to access the project site for the purpose of determining compliance with the rules.
- I understand that this PBR becomes effective 14 calendar days after receipt by the Department of this completed form, the required submissions, and fee, *unless the Department approves or denies the PBR prior to that date.*

By signing this Notification Form, I represent that the project meets all applicability requirements and standards in Chapter 305 rule and that the applicant has sufficient title, right, or interest in the property where the activity takes place.

Signature of Agent or Applicant (may be typed):	Audie Arbo for MaineDOT	Date:	02/18/2022
--	-------------------------	--------------	------------

Keep a copy as a record of permit. Email this completed form with attachments to DEP at: DEP.PBRNotification@maine.gov. DEP will send a copy to the Town Office as evidence of DEP's receipt of notification. No further authorization will be issued by DEP after receipt of notice. A PBR is valid for two years, except Section 4, "Replacement of Structures," are valid for three years. **Work carried out in violation of the Natural Resources Protection Act or any provision in Chapter 305 is subject to enforcement.**