

PAVEMENT MARKING & STENCILING

Regions 1, 2, & 3

WIN 023871.26A

2026

Updated 2/5/2026

FEDERAL PROJECT

BIDDING INSTRUCTIONS

FOR ALL PROJECTS:

1. Use pen and ink to complete all paper Bids.
2. As a minimum, the following must be received prior to the time of Bid opening:

For a Paper Bid:

- a) a copy of the Notice to Contractors, b) the completed Acknowledgement of Bid Amendments form, c) the completed Schedule of Items, d) two copies of the completed and signed Contract Offer, Agreement & Award form, e) a Bid Guaranty, (if required), and f) any other certifications or Bid requirements listed in the Bid Documents as due by Bid opening.

For an Electronic Bid:

NOTE: Not all projects accept Electronic Bids. Please review the Notice to Contractors and see if it specifically states that Electronic Bids will be accepted.

- a) a completed Bid using Expedite® software and submitted via the Bid Express™ web-based service, b) an electronic Bid Guaranty (if required) or a faxed copy of a Bid Bond (with original to be delivered within 72 hours), and c) any other Certifications or Bid requirements listed in the Bid Documents as due by Bid opening.
3. Include prices for all items in the Schedule of Items (excluding non-selected alternates).
4. Bid Guaranty acceptable forms are:
 - a) a properly completed and signed Bid Bond on the Department's prescribed form (or on a form that does not contain any significant variations from the Department's form as determined by the Department) for 5% of the Bid Amount or
 - b) an Official Bank Check, Cashier's Check, Certified Check, U.S. Postal Money Order or Negotiable Certificate of Deposit in the amount stated in the Notice to Contractors or
 - c) an electronic bid bond submitted with an electronic bid.
5. If a paper Bid is to be sent, "FedEx First Overnight" delivery is suggested as the package is delivered directly to the DOT Headquarters Building located at 16 Child Street in Augusta. Other means, such as U.S. Postal Service's Express Mail has proven not to be reliable.

IN ADDITION, FOR FEDERAL AID PROJECTS:

6. Complete the DBE Proposed Utilization form, and submit with your bid. If you are submitting your bid electronically, you must FAX the form to (207) 624-3431. This is a curable defect.

If you need further information regarding Bid preparation, call the DOT Contracts Section at (207) 624-3410.

For complete bidding requirements, refer to Section 102 of the Maine Department of Transportation, Standard Specifications, March 2020 Edition.

February 5, 2026
Supersedes April 28, 2017

NOTICE

The Maine Department of Transportation is attempting to improve the way Bid Amendments/Addendums are handled and allow for an electronic downloading of bid packages from our website, while continuing to maintain an optional plan holders list.

Prospective bidders, subcontractors or suppliers who wish to download a copy of the bid package and receive a courtesy notification of project specific bid amendments must fill out the on-line plan holder registration form and provide an email address to the MDOT Contracts mailbox at: MDOT.contracts@maine.gov. Each bid package will require a separate request.

Additionally, interested parties will be responsible for reviewing and retrieving the Bid Amendments from our web site, and acknowledging receipt and incorporating those Bid Amendments in their bids using the Acknowledgement of Bid Amendment Form.

The downloading of bid packages from the MDOT website is not the same as providing an electronic bid to the Department. Electronic bids must be submitted via <http://www.BIDX.com>. For information on electronic bidding contact Guy Berthiaume at guy.berthiaume@maine.gov.

NOTICE

For security and other reasons, all Bid Packages which are mailed, shall be provided in double (one envelope inside the other) envelopes. The *Inner Envelope* shall have the following information provided on it:

Bid Enclosed - Do Not Open

PIN:

Town:

Date of Bid Opening:

Name of Contractor with mailing address and telephone number:

In Addition to the usual address information, the *Outer Envelope* should have written or typed on it:

Double Envelope: Bid Enclosed

PIN:

Town:

Date of Bid Opening:

Name of Contractor:

This should not be much of a change for those of you who use Federal Express or similar services.

Hand-carried Bids may be in one envelope as before, and should be marked with the following information:

Bid Enclosed: Do Not Open

PIN:

Town:

Name of Contractor:

October 16, 2001

STATE OF MAINE DEPARTMENT OF TRANSPORTATION
Bid Guaranty-Bid Bond Form

KNOW ALL MEN BY THESE PRESENTS THAT _____

_____, of the City/Town of _____ and State of _____

as Principal, and _____ as Surety, a

Corporation duly organized under the laws of the State of _____ and having a usual place of

Business in _____ and hereby held and firmly bound unto the Treasurer of

the State of Maine in the sum of _____, for payment which Principal and Surety bind

themselves, their heirs, executors, administrators, successors and assigns, jointly and severally.

The condition of this obligation is that the Principal has submitted to the Maine Department of

Transportation, hereafter Department, a certain bid, attached hereto and incorporated as a

part herein, to enter into a written contract for the construction of _____

_____ and if the Department shall accept said bid

and the Principal shall execute and deliver a contract in the form attached hereto (properly

completed in accordance with said bid) and shall furnish bonds for this faithful performance of

said contract, and for the payment of all persons performing labor or furnishing material in

connection therewith, and shall in all other respects perform the agreement created by the

acceptance of said bid, then this obligation shall be null and void; otherwise it shall remain in full

force, and effect.

Signed and sealed this _____ day of _____ 20____

WITNESS:

WITNESS

PRINCIPAL:

By _____

By: _____

By: _____

SURETY:

By _____

By: _____

Name of Local Agency: _____

NOTICE

Bidders:

Please use the attached “Request for Information” form when submitting questions concerning specific Contracts that have been advertised for Bid, include additional numbered pages as required. RFI’s may be faxed to 207-624-3431, submitted electronically through the Departments web page of advertised projects by selecting the RFI tab on the project details page or via e-mail to RFI-Contracts.MDOT@maine.gov.

These are the only allowable mechanisms for answering Project specific questions. Maine DOT will not be bound to any answers to Project specific questions received during the Bidding phase through other processes.

When submitting RFIs by Email please follow the same guidelines as stated on the “Request for Information” form and include the word “RFI” along with the Project name and Identification number in the subject line.

NOTICE

BIDDER'S LIST FORM

All Bidders must submit the Bidder's List Form with their bid.

The Bidder's List Form contains information required by USDOT.

The Bidder's List Form must be completed by each Prime Contractor.

A copy of the new Bidder's List Form and instructions for completing it are attached.

The DBE Directory can be found on the MaineDOT Website at: <https://www.maine.gov/mdot/civilrights/dbe/>

Questions about the Directory or this form should be sent to the Civil Rights Office at mary.bryant@maine.gov or by calling 207-624-3056.

INSTRUCTIONS FOR PREPARING THE MAINEDOT BIDDER'S LIST FORM

The Contractor shall extend equal opportunity to MaineDOT certified DBE firms (as listed in MaineDOT's DBE Directory of Certified Businesses) in the selection and utilization of subcontractors and suppliers.

Each prime contractor submitting a bid on a federally funded project must complete each section of the Bidder's List Form in its entirety for itself and each subcontractor on that project.

SPECIFIC INSTRUCTIONS FOR COMPLETING THE FORM:

Section A:

1. Insert Prime Contractor Name
2. Insert WIN for the Federal Project bidding on
3. Insert Bid Date
4. Insert Project Location
5. Insert Email address of Contact Person

Section B:

- A. Enter each Contractor's and Sub-Contractor's name and address (including zip code) – Prime Contractor's name should be listed in first box of this section; then each additional line would be proposed subcontractors – DBE and NonDBE
- B. Enter each Contractor's and Sub-Contractor's annual gross receipts bracket (see the legend on the form)
- C. Enter DBE status (DBE or non-DBE) for each contractor/sub-contractor
- D. Enter each Contractor's and Sub-Contractor's NAICS (North Amer. Industry Classification System) code (may be more than one) and Scope of Work
- E. For each Contractor and Sub-Contractor enter the Race and Gender of the firm's majority owner
- F. Enter the Age of each firm for every Contractor and Sub-Contractor
- G. Enter the Proposed amount of payment (Bid amount) for each Contractor/Sub-Contractor.

**Maine Department of Transportation
BIDDER'S LIST FORM**

Section A. Bidder/Prime Contractor Information.

This section must be completed by the Bidder/Prime Contractor.

1. Prime Contractor Name:	2. Federal Project WIN:	3. Bid Date:
4. Project Location:	5. Email Address:	

Section B. Commitment Details - Prime Contractor and all Proposed Subcontractor Information is Required in This Section

A. Firm's Name & Address, Including Zip Code <small>Prime must be listed first</small>	B. Annual Gross Receipt Bracket Select 1 to 7*	C. Status DBE or Non-DBE	D. NAICS Code(s) and Scope of Work	E. Race & Gender of each Firm's Majority Owner	F. Age of Each Firm	G. Proposed Amount

*1) Less Than \$1M, 2) \$1 - \$3M, 3) \$3 - \$6M, 4) \$6 - \$10M, 5) \$10 - \$20M, 6) \$20 - \$50M, 7) Greater Than \$50M - **More than 5 Subs use a new form**

MaineDOT Use Only:

Form Received: ___/___/___ Verified by: _____
 FHWA FTA FAA

For a complete list of certified DBE firms please visit: <http://www.maine.gov/dot/doing-business/civil-rights/dbe>

Note: This information is required pursuant to 49 CFR §26.11 and is used to track data in all federally funded MaineDOT contracts.

DBE GOAL NOTICE
Maine Department of Transportation
Disadvantaged Business Enterprise Program

Notice is hereby given that in accordance with US DOT regulation 49 CFR Part 26, the Maine Department of Transportation (MaineDOT) has established a Disadvantaged Business Enterprise Program (DBE) for disadvantaged business participation in the federal-aid highway and bridge construction programs; MaineDOT contracts covered by the program include consulting, construction, supplies, manufacturing, and service contracts.

Beginning September 1, 2024, MaineDOT has established an annual DBE participation goal of **1.43%** to be achieved through race/gender neutral means. This goal has been approved by the Federal Highway Administration through August 31, 2027. MaineDOT must meet this goal each federal fiscal year. If the goal is not met, MaineDOT must provide a justification for not meeting the goal and provide a plan to ensure the goal is met, which may include contract goals on certain projects that contractors will be required to meet.

MaineDOT asks all contractors, consultants and subcontractors to seek certified DBE firms for projects and to work to meet the determined 1.43% goal without the need to impose contract goals. DBE firms are listed on the MaineDOT website at:

<http://www.maine.gov/mdot/disadvantaged-business-enterprises/pdf/directory.pdf>

Interested parties may view MaineDOT's DBE goal setting methodology, also posted on this website. If you have questions regarding this goal or the DBE program you may contact Sherry Tompkins at the Maine Department of Transportation, Civil Rights Office by telephone at (207) 624-3066 or by e-mail at: sherry.tompkins@maine.gov

Maine Department of Transportation Civil Rights Office

Directory of Certified Disadvantaged Business Enterprises

Listing can be found at:

<https://www.maine.gov/mdot/civilrights/dbe/>

For additional information and guidance contact:

Civil Rights Office at (207) 624-3056

It is the responsibility of the Contractor to access the DBE Directory at this site in order to have the most current listing.

Vendor Registration

Prospective Bidders must register as a vendor with the Department of Administrative & Financial Services if the vendor is awarded a contract. Vendors will not be able to receive payment without first being registered. Vendors/Contractors will find information and register through the following link –

<http://www.maine.gov/purchases/venbid/index.shtml>

CONTRACTOR INFORMATION

Contractor Name: _____

Mailing Address: _____

Vendor Customer Number: _____

Contact Information (Primary Contact): _____

Phone: _____ **Cell Phone:** _____

Fax: _____

Email: _____

Mailing Address (if different from above): _____

The company has the following organizational structure:

Sole Proprietorship

Limited Liability Company

Partnership

Joint Venture

Corporation

Other: _____

(Date)

(Signature)

(Name and Title Printed)

**STATE OF MAINE DEPARTMENT OF TRANSPORTATION
NOTICE TO CONTRACTORS**

Scaled Bids addressed to the Maine Department of Transportation, Augusta, Maine 04333 and endorsed on the wrapper “Bids for **Pavement Markings and Stenciling** in **Regions 1, 2, & 3**” will be received from contractors at the Reception Desk, MaineDOT Building, Capitol Street, Augusta, Maine, until 11:00 o’clock A.M. (prevailing time) on **April 1, 2026** and at that time and place, publicly opened and read. Bids will be accepted from all bidders. **We now accept electronic bids for bid packages posted on the bidx.com website. Electronic bids do not have to be accompanied by paper bids. Until further notice, dual bids (one paper, one electronic) will be accepted, with the paper copy taking precedence.** The lowest responsive bidder must demonstrate successful completion of projects of similar size and scope to be considered for the award of this contract.

Description: Maine Federal Aid Project No. 2387126, WIN 023871.26A

Location: In Androscoggin, Cumberland, Franklin, Kennebec, Knox, Lincoln, Oxford, Piscataquis, Sagadahoc, Somerset, Waldo, and York Counties.

Outline of Work: Pavement markings, stenciling, and other incidental work.

For general information regarding Bidding and Contracting procedures, contact George Macdougall at (207) 624-3410. Our webpage at <http://www.maine.gov/dot/doing-business/bid-opportunities/> contains a copy of the Schedule of Items, Plan Holders List, written portions of bid amendments, drawings, bid results and an electronic form for RFI submittal. For Project-specific information fax all questions to John McDonough at (207) 624-3431, use electronic RFI form or email questions to RFI-Contracts.MDOT@maine.gov, project name and identification number should be in the subject line. Questions received after 12:00 noon of Friday (or if that Friday is a state holiday, Thursday) prior to bid date will not be answered. Bidders shall not contact any other Departmental staff for clarification of Contract provisions, and the Department will not be responsible for any interpretations so obtained. TTY users call Maine Relay 711.

Bid Documents, plans, specifications and bid forms can be viewed and obtained digitally at no cost at <http://www.maine.gov/dot/doing-business/bid-opportunities/>. They may be purchased from the Department by cash, credit card (Visa/Mastercard) or check payable to Treasurer, State of Maine sent to Maine Department of Transportation, Attn: Mailroom, 24 Child Street, Augusta, Maine 04333-0016. They also may be purchased by telephone at (207) 624-3536. Bid Book \$10 (\$13 by mail), payment in advance, all non-refundable.

If the bid is at a total price greater than \$125,000, it must be accompanied by a bid bond at 5% of the bid amount or an official bank check, cashier’s check, certified check, certificate of deposit, or United States postal money order in the amount of 5% of the bid amount, payable to Treasurer, State of Maine as a Bid guarantee. If the bid is accepted and the total price is greater than \$125,000, a Contract Performance Surety Bond and a Contract Payment Surety Bond, each in the amount of 100 percent of the Contract price, will be required of the successful Bidder.

Each Bid must be made upon blank forms provided by the Department.

This Contract is subject to all applicable Federal Laws. This contract is subject to compliance with the Disadvantaged Business Enterprise program requirements as set forth by the Maine Department of Transportation.

All work shall be governed by *State of Maine, Department of Transportation, Standard Specifications, March 2020 Edition*, price \$10 [\$15 by mail], and *Standard Details, March 2020 Edition*, price \$10 [\$15 by mail]. They also may be purchased by telephone at (207) 624-3536. *Standard Detail* updates can be found at <http://www.maine.gov/dot/doing-business/bid-opportunities/standards/>.

The right is hereby reserved to the MaineDOT to reject any or all bids.

Augusta, Maine
March 11, 2026

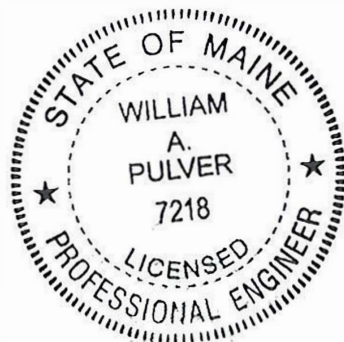

A handwritten signature in blue ink, appearing to read "W. A. Pulver".

WILLIAM A. PULVER, P. E.
CHIEF ENGINEER

NOTICE

All bids for Federal Projects **shall** be accompanied by the DBE Proposed Utilization form. If you are submitting an electronic bid, the DBE Utilization Form may be faxed to 207-624-3431. Failure to submit the form with the bid will be considered a curable defect.

SPECIAL PROVISION 102.7.3
ACKNOWLEDGMENT OF BID AMENDMENTS

With this form, the Bidder acknowledges its responsibility to check for all Amendments to the Bid Package. For each Project under Advertisement, Amendments are located at <http://www.maine.gov/mdot/contractors/> . It is the responsibility of the Bidder to determine if there are Amendments to the Project, to download them, to incorporate them into their Bid Package, and to reference the Amendment number and the date on the form below. The Maine DOT will not post Bid Amendments any later than noon the day before Bid opening without individually notifying all the planholders.

Amendment Number	Date

The Contractor, for itself, its successors and assigns, hereby acknowledges that it has received all of the above referenced Amendments to the Bid Package.

CONTRACTOR

Date

Signature of authorized representative

(Name and Title Printed)

Maine Department of Transportation

Proposal Schedule of Items

Proposal ID: 023871.26A

Project(s): 023871.26A

SECTION: 1 PROJECT ITEMS

Alt Set ID: Alt Mbr ID:

Contractor: _____

Proposal Line Number	Item ID Description	Approximate Quantity and Units	Unit Price		Bid Amount	
			Dollars	Cents	Dollars	Cents
0010	627.75 WHITE OR YELLOW PAVEMENT & CURB MARKING WIN 023871.26A Regions 1, 2, 3	40,000.000 SF	_____	_____	_____	_____
0020	627.77 REMOVING PAVEMENT MARKINGS WIN 023871.26A Regions 1, 2, 3	5,000.000 SF	_____	_____	_____	_____
Section: 1			Total:		_____	_____
			Total Bid:		_____	_____

By signing below, the Bidder (1) represents that the Bidder has examined the Contract Agreement contained in the Bid Documents, the Contract, all documents referenced in said Contract, and the site and scope of work, (2) does hereby bid and offer to enter into this contract to construct and/or perform the Work in strict accordance with the terms and conditions of this Contract at the unit prices bid in the attached "Schedule of Items", (3) represents that the Bidder has given the Department notice of any errors or ambiguities related to the documents or the work that have been discovered by the Bidder, (4) represents that the above-named organization is the legal entity entering into the resulting contract with the Department if they are awarded the contract and, (5) represents that the undersigned is authorized to enter contractual obligations on behalf of the above-named organization.

Bidder acknowledges that the properly completed and signed Schedule of Items provided with the Bid constitutes the Bidder's offer and that this offer shall remain open for 30 calendar days after the date of opening of bids.

The Bidder hereby certifies, to the best of its knowledge and belief that: the Bidder has not, either directly or indirectly, entered into any agreement, participated in any collusion, or otherwise taken any action in restraint of competitive bidding in connection with its bid, and its subsequent contract with the Department.

Use pen and ink to complete paper bids. Signatures shall be original. Stamped and copied signatures will not be accepted.

Signature

Date

(Print Bidder's Name and Title)

CONTRACT AGREEMENT, OFFER & AWARD

AGREEMENT made on the date last signed below, by and between the State of Maine, acting through and by its Department of Transportation (Department), an agency of state government with its principal administrative offices located at Child Street, Augusta, Maine, with a mailing address at 16 State House Station, Augusta, Maine 04333-0016, and _____ (Contractor) a corporation or other legal entity organized under the laws of the State of _____, with its principal place of business located at _____.

The Department and the Contractor, in consideration of the mutual promises set forth in this Agreement (the "Contract"), hereby agree as follows:

A. The Work.

The Contractor agrees to complete all Work as specified or indicated in the Contract including Extra Work in conformity with the Contract, **WIN 023871.26A for Pavement Markings and Stenciling in Regions 1, 2, & 3, Counties of Androscoggin, Cumberland, Franklin, Kennebec, Knox, Lincoln, Oxford, Piscataquis, Sagadahoc, Somerset, Waldo and York**, Maine. The Work includes construction, maintenance during construction, warranty as provided in the Contract, and other incidental work.

The Contractor shall be responsible for furnishing all supervision, labor, equipment, tools supplies, permanent materials and temporary materials required to perform the Work including construction quality control including inspection, testing and documentation, all required documentation at the conclusion of the project, warranting its work and performing all other work indicated in the Contract.

The Department shall have the right to alter the nature and extent of the Work as provided in the Contract; payment to be made as provided in the same.

B. Time.

The Contractor agrees to complete all Work, except warranty work, on or before **October 23, 2026**. Further, the Department may deduct from moneys otherwise due the Contractor, not as a penalty, but as Liquidated Damages in accordance with Sections 107.7 and 107.8 of the *State of Maine Department of Transportation Standard Specifications, March 2020 Edition* and related Special Provisions. The specified Contract Expiration Date is December 31, 2026.

C. Price.

The quantities given in the Schedule of Items of the Bid Package will be used as the basis for determining the original Contract amount and for determining the amounts of the required Performance Surety Bond and Payment Surety Bond, and that the amount of this offer is _____

\$ _____ Performance Bond and Payment Bond each being 100% of the amount of this Contract.

D. Contract.

This Contract, which may be amended, modified, or supplemented in writing only, consists of the Contract documents as defined in the Plans, *Standard Specifications, March 2020 Edition, Standard Details March 2020 Edition* as updated through advertisement, Supplemental Specifications, Special Provisions, Contract Agreement; and Contract Bonds. It is agreed and understood that this Contract will be governed by the documents listed above.

E. Certifications.

By signing below, the Contractor hereby certifies that to the best of the Contractor's knowledge and belief:

1. All of the statements, representations, covenants, and/or certifications required or set forth in the Bid and the Bid Documents, including those in the Federal Contract Provisions Supplement, and the Contract are still complete and accurate as of the date of this Agreement.
2. The Contractor knows of no legal, contractual, or financial impediment to entering into this Contract.
3. The person signing below is legally authorized by the Contractor to sign this Contract on behalf of the Contractor and to legally bind the Contractor to the terms of the Contract.

F. Offer.

The undersigned, having carefully examined the site of work, the Plans, *Standard Specifications March 2020 Edition*, *Standard Details March 2020 Edition* as updated through advertisement, Supplemental Specifications, Special Provisions, Contract Agreement; and Contract Bonds contained herein for construction of:

WIN 023871.26A for Pavement Markings and Stenciling in Regions 1, 2, & 3, Counties of Androscoggin, Cumberland, Franklin, Kennebec, Knox, Lincoln, Oxford, Piscataquis, Sagadahoc, Somerset, Waldo and York,

State of Maine, on which bids will be received until the time specified in the “Notice to Contractors” do(es) hereby bid and offer to enter into this contract to supply all the materials, tools, equipment and labor to construct the whole of the Work in strict accordance with the terms and conditions of this Contract at the unit prices in the attached “Schedule of Items.”

The Offeror agrees to perform the work required at the price specified above and in accordance with the bids provided in the attached “Schedule of Items” in strict accordance with the terms of this solicitation, and to provide the appropriate insurance and bonds if this offer is accepted by the Government in writing.

As Offeror also agrees:

First: To do any extra work, not covered by the attached “Schedule of Items,” which may be ordered by the Resident, and to accept as full compensation the amount determined upon a “Force Account” basis as provided in the *Standard Specifications, March 2020 Edition*, and as addressed in the contract documents.

Second: That the bid bond at 5% of the bid amount or the official bank check, cashier’s check, certificate of deposit or U. S. Postal Money Order in the amount given in the “Notice to Contractors”, payable to the Treasurer of the State of Maine and accompanying this bid, shall be forfeited, as liquidated damages, if in case this bid is accepted, and the undersigned shall fail to abide by the terms and conditions of the offer and fail to furnish satisfactory insurance and Contract bonds under the conditions stipulated in the Specifications within 15 days of notice of intent to award the contract.

Third: To begin the Work as stated in Section 107.2 of the *Standard Specifications March 2020 Edition* and complete the Work within the time limits given in the Special Provisions of this Contract.

Fourth: The Contractor will be bound to the Disadvantaged Business Enterprise (DBE) Requirements contained in the attached Notice (Additional Instructions to Bidders) and submit a completed Contractor’s Disadvantaged Business Enterprise Utilization Plan with their bid.

Fifth: That this offer shall remain open for 30 calendar days after the date of opening of bids.

Sixth: The Bidder hereby certifies, to the best of its knowledge and belief that: the Bidder has not, either directly or indirectly, entered into any agreement, participated in any collusion, or otherwise taken any action in restraint of competitive bidding in connection with its bid, and its subsequent contract with the Department.

IN WITNESS WHEREOF, the Contractor, for itself, its successors and assigns, hereby execute this Agreement and thereby binds itself to all covenants, terms, and obligations contained in the Contract Documents.

CONTRACTOR

Date

(Signature of Legally Authorized Representative
of the Contractor)

Witness

(Name and Title Printed)

G. Award.

Your offer is hereby accepted.
documents referenced herein.

This award consummates the Contract, and the

MAINE DEPARTMENT OF TRANSPORTATION

Date

By: Dale F. Doughty, Commissioner

Witness

CONTRACT AGREEMENT, OFFER & AWARD

AGREEMENT made on the date last signed below, by and between the State of Maine, acting through and by its Department of Transportation (Department), an agency of state government with its principal administrative offices located at Child Street, Augusta, Maine, with a mailing address at 16 State House Station, Augusta, Maine 04333-0016, and _____ (Contractor) a corporation or other legal entity organized under the laws of the State of _____, with its principal place of business located at _____.

The Department and the Contractor, in consideration of the mutual promises set forth in this Agreement (the "Contract"), hereby agree as follows:

A. The Work.

The Contractor agrees to complete all Work as specified or indicated in the Contract including Extra Work in conformity with the Contract, **WIN 023871.26A for Pavement Markings and Stenciling in Regions 1, 2, & 3, Counties of Androscoggin, Cumberland, Franklin, Kennebec, Knox, Lincoln, Oxford, Piscataquis, Sagadahoc, Somerset, Waldo and York**, Maine. The Work includes construction, maintenance during construction, warranty as provided in the Contract, and other incidental work.

The Contractor shall be responsible for furnishing all supervision, labor, equipment, tools supplies, permanent materials and temporary materials required to perform the Work including construction quality control including inspection, testing and documentation, all required documentation at the conclusion of the project, warranting its work and performing all other work indicated in the Contract.

The Department shall have the right to alter the nature and extent of the Work as provided in the Contract; payment to be made as provided in the same.

B. Time.

The Contractor agrees to complete all Work, except warranty work, on or before **October 23, 2026**. Further, the Department may deduct from moneys otherwise due the Contractor, not as a penalty, but as Liquidated Damages in accordance with Sections 107.7 and 107.8 of the *State of Maine Department of Transportation Standard Specifications, March 2020 Edition* and related Special Provisions. The specified Contract Expiration Date is December 31, 2026.

C. Price.

The quantities given in the Schedule of Items of the Bid Package will be used as the basis for determining the original Contract amount and for determining the amounts of the required Performance Surety Bond and Payment Surety Bond, and that the amount of this offer is _____

\$ _____ Performance Bond and Payment Bond each being 100% of the amount of this Contract.

D. Contract.

This Contract, which may be amended, modified, or supplemented in writing only, consists of the Contract documents as defined in the Plans, *Standard Specifications, March 2020 Edition, Standard Details March 2020 Edition* as updated through advertisement, Supplemental Specifications, Special Provisions, Contract Agreement; and Contract Bonds. It is agreed and understood that this Contract will be governed by the documents listed above.

E. Certifications.

By signing below, the Contractor hereby certifies that to the best of the Contractor's knowledge and belief:

1. All of the statements, representations, covenants, and/or certifications required or set forth in the Bid and the Bid Documents, including those in the Federal Contract Provisions Supplement, and the Contract are still complete and accurate as of the date of this Agreement.
2. The Contractor knows of no legal, contractual, or financial impediment to entering into this Contract.
3. The person signing below is legally authorized by the Contractor to sign this Contract on behalf of the Contractor and to legally bind the Contractor to the terms of the Contract.

F. Offer.

The undersigned, having carefully examined the site of work, the Plans, *Standard Specifications March 2020 Edition*, *Standard Details March 2020 Edition* as updated through advertisement, Supplemental Specifications, Special Provisions, Contract Agreement; and Contract Bonds contained herein for construction of:

WIN 023871.26A for Pavement Markings and Stenciling in Regions 1, 2, & 3, Counties of Androscoggin, Cumberland, Franklin, Kennebec, Knox, Lincoln, Oxford, Piscataquis, Sagadahoc, Somerset, Waldo and York,

State of Maine, on which bids will be received until the time specified in the “Notice to Contractors” do(es) hereby bid and offer to enter into this contract to supply all the materials, tools, equipment and labor to construct the whole of the Work in strict accordance with the terms and conditions of this Contract at the unit prices in the attached “Schedule of Items.”

The Offeror agrees to perform the work required at the price specified above and in accordance with the bids provided in the attached “Schedule of Items” in strict accordance with the terms of this solicitation, and to provide the appropriate insurance and bonds if this offer is accepted by the Government in writing.

As Offeror also agrees:

First: To do any extra work, not covered by the attached “Schedule of Items,” which may be ordered by the Resident, and to accept as full compensation the amount determined upon a “Force Account” basis as provided in the *Standard Specifications, March 2020 Edition*, and as addressed in the contract documents.

Second: That the bid bond at 5% of the bid amount or the official bank check, cashier’s check, certificate of deposit or U. S. Postal Money Order in the amount given in the “Notice to Contractors”, payable to the Treasurer of the State of Maine and accompanying this bid, shall be forfeited, as liquidated damages, if in case this bid is accepted, and the undersigned shall fail to abide by the terms and conditions of the offer and fail to furnish satisfactory insurance and Contract bonds under the conditions stipulated in the Specifications within 15 days of notice of intent to award the contract.

Third: To begin the Work as stated in Section 107.2 of the *Standard Specifications March 2020 Edition* and complete the Work within the time limits given in the Special Provisions of this Contract.

Fourth: The Contractor will be bound to the Disadvantaged Business Enterprise (DBE) Requirements contained in the attached Notice (Additional Instructions to Bidders) and submit a completed Contractor’s Disadvantaged Business Enterprise Utilization Plan with their bid.

Fifth: That this offer shall remain open for 30 calendar days after the date of opening of bids.

Sixth: The Bidder hereby certifies, to the best of its knowledge and belief that: the Bidder has not, either directly or indirectly, entered into any agreement, participated in any collusion, or otherwise taken any action in restraint of competitive bidding in connection with its bid, and its subsequent contract with the Department.

IN WITNESS WHEREOF, the Contractor, for itself, its successors and assigns, hereby execute this Agreement and thereby binds itself to all covenants, terms, and obligations contained in the Contract Documents.

CONTRACTOR

Date

(Signature of Legally Authorized Representative
of the Contractor)

Witness

(Name and Title Printed)

G. Award.

Your offer is hereby accepted.
documents referenced herein.

This award consummates the Contract, and the

MAINE DEPARTMENT OF TRANSPORTATION

Date

By: Dale F. Doughty, Commissioner

Witness

CONTRACT AGREEMENT, OFFER & AWARD

AGREEMENT made on the date last signed below, by and between the State of Maine, acting through and by its Department of Transportation (Department), an agency of state government with its principal administrative offices located at Child Street, Augusta, Maine, with a mailing address at 16 State House Station, Augusta, Maine 04333-0016, and _____ **(Name of the firm bidding the job)** **(Contractor)** a corporation or other legal entity organized under the laws of the State of Maine, with its principal place of business located at _____ **(address of the firm bidding the job)**

The Department and the Contractor, in consideration of the mutual promises set forth in this Agreement (the "Contract"), hereby agree as follows:

A. The Work.

The Contractor agrees to complete all Work as specified or indicated in the Contract including Extra Work in conformity with the Contract, **WIN 12345.00**, for the **Hot Mix Asphalt Overlay** in the town/city of **South Nowhere**, County of **Washington**, Maine. The Work includes construction, maintenance during construction, warranty as provided in the Contract, and other incidental work.

The Contractor shall be responsible for furnishing all supervision, labor, equipment, tools supplies, permanent materials and temporary materials required to perform the Work including construction quality control including inspection, testing and documentation, all required documentation at the conclusion of the project, warranting its work and performing all other work indicated in the Contract.

The Department shall have the right to alter the nature and extent of the Work as provided in the Contract; payment to be made as provided in the same.

B. Time.

The Contractor agrees to complete all Work, except warranty work, on or before **November 15, 2006**. Further, the Department may deduct from moneys otherwise due the Contractor, not as a penalty, but as Liquidated Damages in accordance with Sections 107.7 and 107.8 of the *State of Maine Department of Transportation Standard Specifications, March 2020 Edition* and related Special Provisions.

C. Price.

The quantities given in the Schedule of Items of the Bid Package will be used as the basis for determining the original Contract amount and for determining the amounts of the required Performance Surety Bond and Payment Surety Bond, and that the amount of this offer is (Place bid here in alphabetical form such as One Hundred and Two dollars and 10 cents)
\$ (repeat bid here in numerical terms, such as \$102.10) Performance Bond and Payment Bond each being 100% of the amount of this Contract.

D. Contract.

This Contract, which may be amended, modified, or supplemented in writing only, consists of the Contract documents as defined in the Plans, *Standard Specifications, March 2020 Edition, Standard Details March 2020 Edition*, Supplemental Specifications, Special Provisions, Contract Agreement; and Contract Bonds. It is agreed and understood that this Contract will be governed by the documents listed above.

E. Certifications.

By signing below, the Contractor hereby certifies that to the best of the Contractor's knowledge and belief:

1. All of the statements, representations, covenants, and/or certifications required or set forth in the Bid and the Bid Documents, including those in Appendix A to Division 100 of the *Standard Specifications March 2020 Edition* (Federal Contract Provisions Supplement), and the Contract are still complete and accurate as of the date of this Agreement.
2. The Contractor knows of no legal, contractual, or financial impediment to entering into this Contract.
3. The person signing below is legally authorized by the Contractor to sign this Contract on behalf of the Contractor and to legally bind the Contractor to the terms of the Contract.

F. Offer.

The undersigned, having carefully examined the site of work, the Plans, *Standard Specifications, March 2020 Edition, Standard Details March 2020 Edition, Supplemental Specifications, Special Provisions, Contract Agreement; and Contract Bonds* contained herein for construction of:

WIN 012345.00 South Nowhere, Hot Mix Asphalt Overlay

State of Maine, on which bids will be received until the time specified in the “Notice to Contractors” do(es) hereby bid and offer to enter into this contract to supply all the materials, tools, equipment and labor to construct the whole of the Work in strict accordance with the terms and conditions of this Contract at the unit prices in the attached “Schedule of Items.”

The Offeror agrees to perform the work required at the price specified above and in accordance with the bids provided in the attached “Schedule of Items” in strict accordance with the terms of this solicitation, and to provide the appropriate insurance and bonds if this offer is accepted by the Government in writing.

As Offeror also agrees:

First: To do any extra work, not covered by the attached “Schedule of Items,” which may be ordered by the Resident, and to accept as full compensation the amount determined upon a “Force Account” basis as provided in the *Standard Specifications, March 2020 Edition*, and as addressed in the contract documents.

Second: That the bid bond at 5% of the bid amount or the official bank check, cashier’s check, certificate of deposit or U. S. Postal Money Order in the amount given in the “Notice to Contractors”, payable to the Treasurer of the State of Maine and accompanying this bid, shall be forfeited, as liquidated damages, if in case this bid is accepted, and the undersigned shall fail to abide by the terms and conditions of the offer and fail to furnish satisfactory insurance and Contract bonds under the conditions stipulated in the Specifications within 15 days of notice of intent to award the contract.

Third: To begin the Work as stated in Section 107.2 of the *Standard Specifications March 2020 Edition* and complete the Work within the time limits given in the Special Provisions of this Contract.

Fourth: The Contractor will be bound to the Disadvantaged Business Enterprise (DBE) Requirements contained in the attached Notice (Additional Instructions to Bidders) and submit a completed Contractor’s Disadvantaged Business Enterprise Utilization Plan with their bid.

Fifth: That this offer shall remain open for 30 calendar days after the date of opening of bids.

Sixth: The Bidder hereby certifies, to the best of its knowledge and belief that: the Bidder has not, either directly or indirectly, entered into any agreement, participated in any collusion, or otherwise taken any action in restraint of competitive bidding in connection with its bid, and its subsequent contract with the Department.

IN WITNESS WHEREOF, the Contractor, for itself, its successors and assigns, hereby execute this Agreement and thereby binds itself to all covenants, terms, and obligations contained in the Contract Documents.

CONTRACTOR

(Print Date here)
Date

(Sign Here)
(Signature of Legally Authorized Representative of the Contractor)

(Witness Sign Here)
Witness

(Print Name Here)
(Name and Title Printed)

G. Award.

Your offer is hereby accepted. This award consummates the Contract, and the documents referenced herein.

This award consummates the Contract, and the documents referenced herein.

MAINE DEPARTMENT OF TRANSPORTATION

Date

By: Bruce A. Van Note, Commissioner

(Witness)

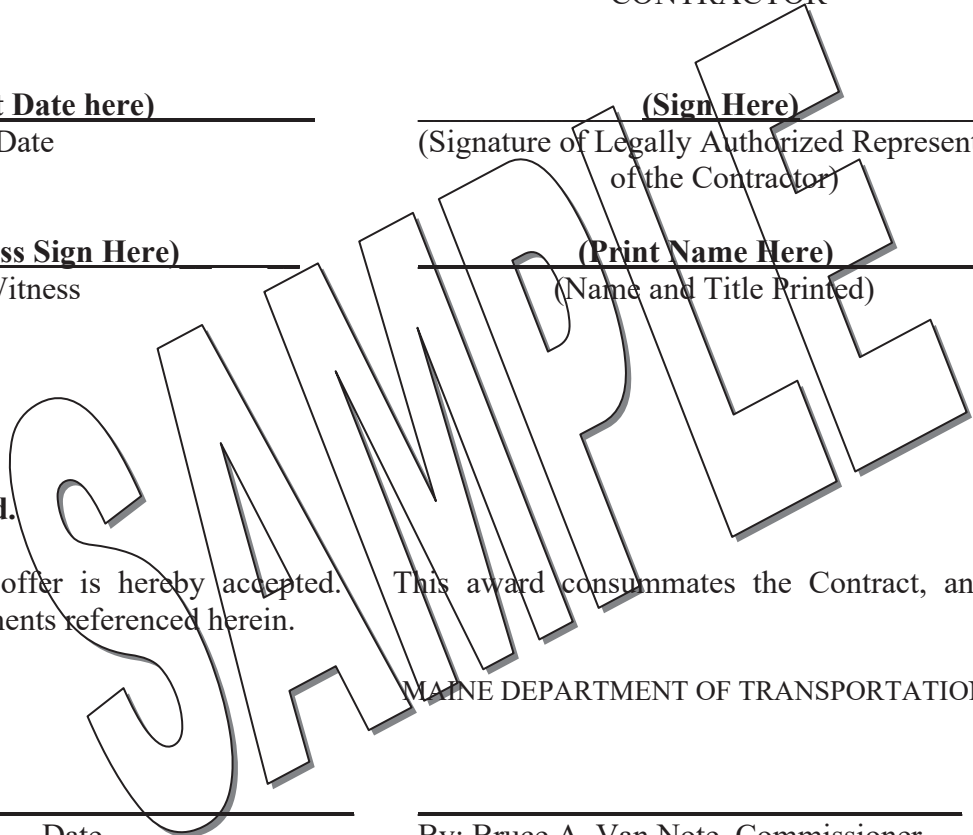

BOND # _____

CONTRACT PERFORMANCE BOND
(Surety Company Form)

KNOW ALL MEN BY THESE PRESENTS: That _____
_____ in the State of _____, as principal,
and.....
a corporation duly organized under the laws of the State of and having a
usual place of business
as Surety, are held and firmly bound unto the Treasurer of the State of Maine in the sum
of _____ and 00/100 Dollars (\$ _____),
to be paid said Treasurer of the State of Maine or his successors in office, for which
payment well and truly to be made, Principal and Surety bind themselves, their heirs,
executors and administrators, successors and assigns, jointly and severally by these
presents.

The condition of this obligation is such that if the Principal designated as Contractor in
the Contract to construct Project Number _____ in the Municipality of
_____ promptly and faithfully performs the Contract, then this
obligation shall be null and void; otherwise it shall remain in full force and effect.

The Surety hereby waives notice of any alteration or extension of time made by the State
of Maine.

Signed and sealed this day of, 20.....

WITNESSES:

SIGNATURES:

CONTRACTOR:

Signature.....

.....

Print Name Legibly

Print Name Legibly

SURETY:

Signature

.....

Print Name Legibly

Print Name Legibly

SURETY ADDRESS:

NAME OF LOCAL AGENCY:

.....
.....
.....

ADDRESS
.....
.....

TELEPHONE.....

.....

BOND # _____

CONTRACT PAYMENT BOND
(Surety Company Form)

KNOW ALL MEN BY THESE PRESENTS: That _____
_____ **in the State of** _____, as principal,
and.....

a corporation duly organized under the laws of the State of and having a
usual place of business in
as Surety, are held and firmly bound unto the Treasurer of the State of Maine for the use
and benefit of claimants as herein below defined, in the sum of
_____ **and 00/100 Dollars (\$** _____ **)**
for the payment whereof Principal and Surety bind themselves, their heirs, executors and
administrators, successors and assigns, jointly and severally by these presents.

The condition of this obligation is such that if the Principal designated as Contractor in
the Contract to construct Project Number _____ in the Municipality of
_____ promptly satisfies all claims and demands incurred for all
labor and material, used or required by him in connection with the work contemplated by
said Contract, and fully reimburses the obligee for all outlay and expense which the
obligee may incur in making good any default of said Principal, then this obligation shall
be null and void; otherwise it shall remain in full force and effect.

A claimant is defined as one having a direct contract with the Principal or with a
Subcontractor of the Principal for labor, material or both, used or reasonably required for
use in the performance of the contract.

Signed and sealed this day of, 20

WITNESS:

SIGNATURES:

CONTRACTOR:

Signature.....

.....

Print Name Legibly

Print Name Legibly

SURETY:

Signature.....

.....

Print Name Legibly

Print Name Legibly

SURETY ADDRESS:

NAME OF LOCAL AGENCY:

.....

ADDRESS

.....

.....

TELEPHONE

.....

"General Decision Number: ME20260045 01/02/2026

Superseded General Decision Number: ME20250045

State: Maine

Construction Type: Highway

County: Androscoggin County in Maine.

HIGHWAY CONSTRUCTION PROJECTS

Modification Number 0 Publication Date 01/02/2026

SUME2014-040 06/23/2017

	Rates	Fringes
CARPENTER, Includes Form Work....	\$ 18.95	3.23
CEMENT MASON/CONCRETE FINISHER...	\$ 19.27	1.13
ELECTRICIAN.....	\$ 25.21	5.63
HIGHWAY/PARKING LOT STRIPING: Laborer.....	\$ 15.53	2.04
INSTALLER - GUARDRAIL.....	\$ 19.98	2.55
IRONWORKER, REINFORCING.....	\$ 21.85	0.00
IRONWORKER, STRUCTURAL.....	\$ 22.33	4.50
LABORER: Asphalt, Includes Raker, Shoveler, Spreader and Distributor.....	\$ 16.71	0.63
LABORER: Common or General.....	\$ 14.65	1.64
LABORER: Epoxy Injector (Concrete).....	\$ 13.43	1.15
LABORER: Wheelman.....	\$ 22.87	3.79
OPERATOR: Backhoe/Excavator/Trackhoe.....	\$ 20.09	3.20
OPERATOR: Bobcat/Skid Steer/Skid Loader.....	\$ 21.03	3.43
OPERATOR: Broom/Sweeper.....	\$ 19.52	0.00
OPERATOR: Bulldozer.....	\$ 21.71	5.67
OPERATOR: Grader/Blade.....	\$ 27.40	8.13
OPERATOR: Loader.....	\$ 19.52	3.19
OPERATOR: Mechanic.....	\$ 24.69	8.18
OPERATOR: Milling Machine.....	\$ 28.51	5.44
OPERATOR: Paver (Asphalt,		

Aggregate, and Concrete).....\$ 20.86	3.73
OPERATOR: Roller (Earth).....\$ 14.74	1.29
OPERATOR: Roller Asphalt.....\$ 19.14	3.43
TRAFFIC CONTROL: Flagger.....\$ 9.06	0.00
TRAFFIC CONTROL:	
Laborer-Cones/	
Barricades/Barrels -	
Setter/Mover/Sweeper.....\$ 17.02	5.37
TRUCK DRIVER: Dump Truck.....\$ 15.60	1.38

WELDERS - Receive rate prescribed for craft performing operation to which welding is incidental.

=====
Note: Executive Order (EO) 13706, Establishing Paid Sick Leave for Federal Contractors applies to all contracts subject to the Davis-Bacon Act for which the contract is awarded (and any solicitation was issued) on or after January 1, 2017. If this contract is covered by the EO, the contractor must provide employees with 1 hour of paid sick leave for every 30 hours they work, up to 56 hours of paid sick leave each year. Employees must be permitted to use paid sick leave for their own illness, injury or other health-related needs, including preventive care; to assist a family member (or person who is like family to the employee) who is ill, injured, or has other health-related needs, including preventive care; or for reasons resulting from, or to assist a family member (or person who is like family to the employee) who is a victim of, domestic violence, sexual assault, or stalking. Additional information on contractor requirements and worker protections under the EO is available at <https://www.dol.gov/agencies/whd/government-contracts>.

Note: Executive Order 13658 generally applies to contracts subject to the Davis-Bacon Act that were awarded on or between January 1, 2015 and January 29, 2022, and that have not been renewed or extended on or after January 30, 2022. Executive Order 13658 does not apply to contracts subject only to the Davis-Bacon Related Acts regardless of when they were awarded. If a contract is subject to Executive Order 13658, the contractor must pay all covered workers at least \$13.30 per hour (or the applicable wage rate listed on this wage determination, if it is higher) for all hours spent performing on the contract in 2025. The applicable Executive Order minimum wage rate will be adjusted annually. Additional information on contractor requirements and worker protections under Executive Order 13658 is available at www.dol.gov/whd/govcontracts.

Unlisted classifications needed for work not included within the scope of the classifications listed may be added after award only as provided in the labor standards contract clauses (29CFR 5.5 (a) (1) (iii)).

The body of each wage determination lists the classifications

and wage rates that have been found to be prevailing for the type(s) of construction and geographic area covered by the wage determination. The classifications are listed in alphabetical order under rate identifiers indicating whether the particular rate is a union rate (current union negotiated rate), a survey rate, a weighted union average rate, a state adopted rate, or a supplemental classification rate.

Union Rate Identifiers

A four-letter identifier beginning with characters other than ""SU"", ""UAVG"", ?SA?, or ?SC? denotes that a union rate was prevailing for that classification in the survey. Example: PLUM0198-005 07/01/2024. PLUM is an identifier of the union whose collectively bargained rate prevailed in the survey for this classification, which in this example would be Plumbers. 0198 indicates the local union number or district council number where applicable, i.e., Plumbers Local 0198. The next number, 005 in the example, is an internal number used in processing the wage determination. The date, 07/01/2024 in the example, is the effective date of the most current negotiated rate.

Union prevailing wage rates are updated to reflect all changes over time that are reported to WHD in the rates in the collective bargaining agreement (CBA) governing the classification.

Union Average Rate Identifiers

The UAVG identifier indicates that no single rate prevailed for those classifications, but that 100% of the data reported for the classifications reflected union rates. EXAMPLE: UAVG-OH-0010 01/01/2024. UAVG indicates that the rate is a weighted union average rate. OH indicates the State of Ohio. The next number, 0010 in the example, is an internal number used in producing the wage determination. The date, 01/01/2024 in the example, indicates the date the wage determination was updated to reflect the most current union average rate.

A UAVG rate will be updated once a year, usually in January, to reflect a weighted average of the current rates in the collective bargaining agreements on which the rate is based.

Survey Rate Identifiers

The ""SU"" identifier indicates that either a single non-union rate prevailed (as defined in 29 CFR 1.2) for this classification in the survey or that the rate was derived by computing a weighted average rate based on all the rates reported in the survey for that classification. As a weighted average rate includes all rates reported in the survey, it may include both union and non-union rates. Example: SUFL2022-007 6/27/2024. SU indicates the rate is a single non-union prevailing rate or a weighted average of survey data for that classification. FL indicates the State of Florida. 2022 is the year of the survey on which these classifications and rates are based. The next number, 007 in the example, is an internal number used in producing the wage determination. The date, 6/27/2024 in the example, indicates the survey completion date for the classifications and rates under that identifier.

?SU? wage rates typically remain in effect until a new survey is conducted. However, the Wage and Hour Division (WHD) has the discretion to update such rates under 29 CFR 1.6(c)(1).

State Adopted Rate Identifiers

The ""SA"" identifier indicates that the classifications and prevailing wage rates set by a state (or local) government were adopted under 29 C.F.R 1.3(g)-(h). Example: SAME2023-007 01/03/2024. SA reflects that the rates are state adopted. ME refers to the State of Maine. 2023 is the year during which the state completed the survey on which the listed classifications and rates are based. The next number, 007 in the example, is an internal number used in producing the wage determination. The date, 01/03/2024 in the example, reflects the date on which the classifications and rates under the ?SA? identifier took effect under state law in the state from which the rates were adopted.

WAGE DETERMINATION APPEALS PROCESS

1) Has there been an initial decision in the matter? This can be:

- a) a survey underlying a wage determination
- b) an existing published wage determination
- c) an initial WHD letter setting forth a position on a wage determination matter
- d) an initial conformance (additional classification and rate) determination

On survey related matters, initial contact, including requests for summaries of surveys, should be directed to the WHD Branch of Wage Surveys. Requests can be submitted via email to davisbaconinfo@dol.gov or by mail to:

Branch of Wage Surveys
Wage and Hour Division
U.S. Department of Labor
200 Constitution Avenue, N.W.
Washington, DC 20210

Regarding any other wage determination matter such as conformance decisions, requests for initial decisions should be directed to the WHD Branch of Construction Wage Determinations. Requests can be submitted via email to BCWD-Office@dol.gov or by mail to:

Branch of Construction Wage Determinations
Wage and Hour Division
U.S. Department of Labor
200 Constitution Avenue, N.W.
Washington, DC 20210

2) If an initial decision has been issued, then any interested party (those affected by the action) that disagrees with the decision can request review and reconsideration from the Wage and Hour Administrator (See 29 CFR Part 1.8 and 29 CFR Part 7). Requests for review and reconsideration can be submitted via email to dba.reconsideration@dol.gov or by mail to:

Wage and Hour Administrator
U.S. Department of Labor
200 Constitution Avenue, N.W.
Washington, DC 20210

The request should be accompanied by a full statement of the interested party's position and any information (wage payment data, project description, area practice material, etc.) that the requestor considers relevant to the issue.

3) If the decision of the Administrator is not favorable, an interested party may appeal directly to the Administrative Review Board (formerly the Wage Appeals Board). Write to:

Administrative Review Board
U.S. Department of Labor
200 Constitution Avenue, N.W.
Washington, DC 20210.

=====

END OF GENERAL DECISION

..

"General Decision Number: ME20260046 01/02/2026

Superseded General Decision Number: ME20250046

State: Maine

Construction Type: Highway

County: Cumberland County in Maine.

HIGHWAY CONSTRUCTION PROJECTS

Modification Number 0 Publication Date 01/02/2026

SUME2014-041 06/23/2017

	Rates	Fringes
CARPENTER, Includes Form Work....	\$ 18.95	3.23
CEMENT MASON/CONCRETE FINISHER...	\$ 19.27	1.13
ELECTRICIAN.....	\$ 26.40	6.66
HIGHWAY/PARKING LOT STRIPING: Laborer.....	\$ 15.53	2.04
INSTALLER - GUARDRAIL.....	\$ 19.98	2.55
IRONWORKER, REINFORCING.....	\$ 21.85	0.00
IRONWORKER, STRUCTURAL.....	\$ 22.33	4.50
LABORER: Asphalt, Includes Raker, Shoveler, Spreader and Distributor.....	\$ 17.44	2.07
LABORER: Common or General.....	\$ 15.29	2.08
LABORER: Epoxy Injector (Concrete).....	\$ 13.43	1.15
LABORER: Wheelman.....	\$ 20.34	3.43
OPERATOR: Backhoe/Excavator/Trackhoe.....	\$ 21.07	4.39
OPERATOR: Bobcat/Skid Steer/Skid Loader.....	\$ 21.97	1.74
OPERATOR: Broom/Sweeper.....	\$ 19.02	0.00
OPERATOR: Bulldozer.....	\$ 21.71	5.67
OPERATOR: Grader/Blade.....	\$ 27.40	8.13
OPERATOR: Loader.....	\$ 19.95	2.86
OPERATOR: Mechanic.....	\$ 24.69	8.18
OPERATOR: Milling Machine.....	\$ 28.51	5.44
OPERATOR: Paver (Asphalt,		

Aggregate, and Concrete).....\$ 19.98	4.95
OPERATOR: Roller (Earth).....\$ 18.57	2.50
OPERATOR: Roller Asphalt.....\$ 19.30	4.09
TRAFFIC CONTROL: Flagger.....\$ 9.00	0.00
TRAFFIC CONTROL: Laborer-Cones/ Barricades/Barrels - Setter/Mover/Sweeper.....\$ 17.02	
TRUCK DRIVER: Dump Truck.....\$ 16.71	2.80

WELDERS - Receive rate prescribed for craft performing operation to which welding is incidental.

=====

Note: Executive Order (EO) 13706, Establishing Paid Sick Leave for Federal Contractors applies to all contracts subject to the Davis-Bacon Act for which the contract is awarded (and any solicitation was issued) on or after January 1, 2017. If this contract is covered by the EO, the contractor must provide employees with 1 hour of paid sick leave for every 30 hours they work, up to 56 hours of paid sick leave each year. Employees must be permitted to use paid sick leave for their own illness, injury or other health-related needs, including preventive care; to assist a family member (or person who is like family to the employee) who is ill, injured, or has other health-related needs, including preventive care; or for reasons resulting from, or to assist a family member (or person who is like family to the employee) who is a victim of, domestic violence, sexual assault, or stalking. Additional information on contractor requirements and worker protections under the EO is available at <https://www.dol.gov/agencies/whd/government-contracts>.

Note: Executive Order 13658 generally applies to contracts subject to the Davis-Bacon Act that were awarded on or between January 1, 2015 and January 29, 2022, and that have not been renewed or extended on or after January 30, 2022. Executive Order 13658 does not apply to contracts subject only to the Davis-Bacon Related Acts regardless of when they were awarded. If a contract is subject to Executive Order 13658, the contractor must pay all covered workers at least \$13.30 per hour (or the applicable wage rate listed on this wage determination, if it is higher) for all hours spent performing on the contract in 2025. The applicable Executive Order minimum wage rate will be adjusted annually. Additional information on contractor requirements and worker protections under Executive Order 13658 is available at www.dol.gov/whd/govcontracts.

Unlisted classifications needed for work not included within the scope of the classifications listed may be added after award only as provided in the labor standards contract clauses (29CFR 5.5 (a) (1) (iii)).

The body of each wage determination lists the classifications

and wage rates that have been found to be prevailing for the type(s) of construction and geographic area covered by the wage determination. The classifications are listed in alphabetical order under rate identifiers indicating whether the particular rate is a union rate (current union negotiated rate), a survey rate, a weighted union average rate, a state adopted rate, or a supplemental classification rate.

Union Rate Identifiers

A four-letter identifier beginning with characters other than ""SU"", ""UAVG"", ?SA?, or ?SC? denotes that a union rate was prevailing for that classification in the survey. Example: PLUM0198-005 07/01/2024. PLUM is an identifier of the union whose collectively bargained rate prevailed in the survey for this classification, which in this example would be Plumbers. 0198 indicates the local union number or district council number where applicable, i.e., Plumbers Local 0198. The next number, 005 in the example, is an internal number used in processing the wage determination. The date, 07/01/2024 in the example, is the effective date of the most current negotiated rate.

Union prevailing wage rates are updated to reflect all changes over time that are reported to WHD in the rates in the collective bargaining agreement (CBA) governing the classification.

Union Average Rate Identifiers

The UAVG identifier indicates that no single rate prevailed for those classifications, but that 100% of the data reported for the classifications reflected union rates. EXAMPLE: UAVG-OH-0010 01/01/2024. UAVG indicates that the rate is a weighted union average rate. OH indicates the State of Ohio. The next number, 0010 in the example, is an internal number used in producing the wage determination. The date, 01/01/2024 in the example, indicates the date the wage determination was updated to reflect the most current union average rate.

A UAVG rate will be updated once a year, usually in January, to reflect a weighted average of the current rates in the collective bargaining agreements on which the rate is based.

Survey Rate Identifiers

The ""SU"" identifier indicates that either a single non-union rate prevailed (as defined in 29 CFR 1.2) for this classification in the survey or that the rate was derived by computing a weighted average rate based on all the rates reported in the survey for that classification. As a weighted average rate includes all rates reported in the survey, it may include both union and non-union rates. Example: SUFL2022-007 6/27/2024. SU indicates the rate is a single non-union prevailing rate or a weighted average of survey data for that classification. FL indicates the State of Florida. 2022 is the year of the survey on which these classifications and rates are based. The next number, 007 in the example, is an internal number used in producing the wage determination. The date, 6/27/2024 in the example, indicates the survey completion date for the classifications and rates under that identifier.

?SU? wage rates typically remain in effect until a new survey is conducted. However, the Wage and Hour Division (WHD) has the discretion to update such rates under 29 CFR 1.6(c)(1).

State Adopted Rate Identifiers

The ""SA"" identifier indicates that the classifications and prevailing wage rates set by a state (or local) government were adopted under 29 C.F.R 1.3(g)-(h). Example: SAME2023-007 01/03/2024. SA reflects that the rates are state adopted. ME refers to the State of Maine. 2023 is the year during which the state completed the survey on which the listed classifications and rates are based. The next number, 007 in the example, is an internal number used in producing the wage determination. The date, 01/03/2024 in the example, reflects the date on which the classifications and rates under the ?SA? identifier took effect under state law in the state from which the rates were adopted.

WAGE DETERMINATION APPEALS PROCESS

1) Has there been an initial decision in the matter? This can be:

- a) a survey underlying a wage determination
- b) an existing published wage determination
- c) an initial WHD letter setting forth a position on a wage determination matter
- d) an initial conformance (additional classification and rate) determination

On survey related matters, initial contact, including requests for summaries of surveys, should be directed to the WHD Branch of Wage Surveys. Requests can be submitted via email to davisbaconinfo@dol.gov or by mail to:

Branch of Wage Surveys
Wage and Hour Division
U.S. Department of Labor
200 Constitution Avenue, N.W.
Washington, DC 20210

Regarding any other wage determination matter such as conformance decisions, requests for initial decisions should be directed to the WHD Branch of Construction Wage Determinations. Requests can be submitted via email to BCWD-Office@dol.gov or by mail to:

Branch of Construction Wage Determinations
Wage and Hour Division
U.S. Department of Labor
200 Constitution Avenue, N.W.
Washington, DC 20210

2) If an initial decision has been issued, then any interested party (those affected by the action) that disagrees with the decision can request review and reconsideration from the Wage and Hour Administrator (See 29 CFR Part 1.8 and 29 CFR Part 7). Requests for review and reconsideration can be submitted via email to dba.reconsideration@dol.gov or by mail to:

Wage and Hour Administrator
U.S. Department of Labor
200 Constitution Avenue, N.W.
Washington, DC 20210

The request should be accompanied by a full statement of the interested party's position and any information (wage payment data, project description, area practice material, etc.) that the requestor considers relevant to the issue.

3) If the decision of the Administrator is not favorable, an interested party may appeal directly to the Administrative Review Board (formerly the Wage Appeals Board). Write to:

Administrative Review Board
U.S. Department of Labor
200 Constitution Avenue, N.W.
Washington, DC 20210.

=====

END OF GENERAL DECISION

..

"General Decision Number: ME20260035 01/02/2026

Superseded General Decision Number: ME20250035

State: Maine

Construction Type: Highway

County: Franklin County in Maine.

HIGHWAY CONSTRUCTION PROJECTS

Modification Number 0 Publication Date 01/02/2026

ENGI0004-022 04/01/2025

	Rates	Fringes
POWER EQUIPMENT OPERATOR: Grader/Blade, Milling Machine.....	\$ 30.17	13.80

SUME2014-030 06/23/2017

	Rates	Fringes
CARPENTER, Includes Form Work....	\$ 18.34	2.84
HIGHWAY/PARKING LOT STRIPING: Laborer.....	\$ 14.80	1.27
IRONWORKER, REINFORCING.....	\$ 16.27	0.00
LABORER: Asphalt, Includes Raker, Shoveler, Spreader and Distributor.....	\$ 15.40	2.69
LABORER: Common or General.....	\$ 14.45	2.16
LABORER: Landscape.....	\$ 18.69	2.70
LABORER: Wheelman.....	\$ 15.64	4.29
OPERATOR: Backhoe/Excavator/Trackhoe.....	\$ 18.80	4.16
OPERATOR: Bobcat/Skid Steer/Skid Loader.....	\$ 21.66	4.91
OPERATOR: Broom/Sweeper.....	\$ 19.09	5.20
OPERATOR: Bulldozer.....	\$ 17.30	3.50
OPERATOR: Loader.....	\$ 18.59	5.53
OPERATOR: Mechanic.....	\$ 22.07	8.73
OPERATOR: Paver (Asphalt, Aggregate, and Concrete).....	\$ 21.46	8.78
OPERATOR: Screed.....	\$ 19.02	4.82
OPERATOR: Roller (Earth).....	\$ 16.43	3.40

OPERATOR: Roller Asphalt.....	\$ 21.97	7.81
TRAFFIC CONTROL: Flagger.....	\$ 9.38	0.00
TRAFFIC CONTROL:		
Laborer-Cones/ Barricades/Barrels - Setter/Mover/Sweeper.....		
	\$ 17.47	4.80
TRUCK DRIVER: Dump Truck.....	\$ 15.07	5.15
TRUCK DRIVER: TackTruck.....	\$ 20.18	7.75

WELDERS - Receive rate prescribed for craft performing operation to which welding is incidental.

=====

Note: Executive Order (EO) 13706, Establishing Paid Sick Leave for Federal Contractors applies to all contracts subject to the Davis-Bacon Act for which the contract is awarded (and any solicitation was issued) on or after January 1, 2017. If this contract is covered by the EO, the contractor must provide employees with 1 hour of paid sick leave for every 30 hours they work, up to 56 hours of paid sick leave each year. Employees must be permitted to use paid sick leave for their own illness, injury or other health-related needs, including preventive care; to assist a family member (or person who is like family to the employee) who is ill, injured, or has other health-related needs, including preventive care; or for reasons resulting from, or to assist a family member (or person who is like family to the employee) who is a victim of, domestic violence, sexual assault, or stalking. Additional information on contractor requirements and worker protections under the EO is available at <https://www.dol.gov/agencies/whd/government-contracts>.

Note: Executive Order 13658 generally applies to contracts subject to the Davis-Bacon Act that were awarded on or between January 1, 2015 and January 29, 2022, and that have not been renewed or extended on or after January 30, 2022. Executive Order 13658 does not apply to contracts subject only to the Davis-Bacon Related Acts regardless of when they were awarded. If a contract is subject to Executive Order 13658, the contractor must pay all covered workers at least \$13.30 per hour (or the applicable wage rate listed on this wage determination, if it is higher) for all hours spent performing on the contract in 2025. The applicable Executive Order minimum wage rate will be adjusted annually. Additional information on contractor requirements and worker protections under Executive Order 13658 is available at www.dol.gov/whd/govcontracts.

Unlisted classifications needed for work not included within the scope of the classifications listed may be added after award only as provided in the labor standards contract clauses (29CFR 5.5 (a) (1) (iii)).

The body of each wage determination lists the classifications and wage rates that have been found to be prevailing for the

type(s) of construction and geographic area covered by the wage determination. The classifications are listed in alphabetical order under rate identifiers indicating whether the particular rate is a union rate (current union negotiated rate), a survey rate, a weighted union average rate, a state adopted rate, or a supplemental classification rate.

Union Rate Identifiers

A four-letter identifier beginning with characters other than ""SU"", ""UAVG"", ?SA?, or ?SC? denotes that a union rate was prevailing for that classification in the survey. Example: PLUM0198-005 07/01/2024. PLUM is an identifier of the union whose collectively bargained rate prevailed in the survey for this classification, which in this example would be Plumbers. 0198 indicates the local union number or district council number where applicable, i.e., Plumbers Local 0198. The next number, 005 in the example, is an internal number used in processing the wage determination. The date, 07/01/2024 in the example, is the effective date of the most current negotiated rate.

Union prevailing wage rates are updated to reflect all changes over time that are reported to WHD in the rates in the collective bargaining agreement (CBA) governing the classification.

Union Average Rate Identifiers

The UAVG identifier indicates that no single rate prevailed for those classifications, but that 100% of the data reported for the classifications reflected union rates. EXAMPLE: UAVG-OH-0010 01/01/2024. UAVG indicates that the rate is a weighted union average rate. OH indicates the State of Ohio. The next number, 0010 in the example, is an internal number used in producing the wage determination. The date, 01/01/2024 in the example, indicates the date the wage determination was updated to reflect the most current union average rate.

A UAVG rate will be updated once a year, usually in January, to reflect a weighted average of the current rates in the collective bargaining agreements on which the rate is based.

Survey Rate Identifiers

The ""SU"" identifier indicates that either a single non-union rate prevailed (as defined in 29 CFR 1.2) for this classification in the survey or that the rate was derived by computing a weighted average rate based on all the rates reported in the survey for that classification. As a weighted average rate includes all rates reported in the survey, it may include both union and non-union rates. Example: SUFL2022-007 6/27/2024. SU indicates the rate is a single non-union prevailing rate or a weighted average of survey data for that classification. FL indicates the State of Florida. 2022 is the year of the survey on which these classifications and rates are based. The next number, 007 in the example, is an internal number used in producing the wage determination. The date, 6/27/2024 in the example, indicates the survey completion date for the classifications and rates under that identifier.

?SU? wage rates typically remain in effect until a new survey is conducted. However, the Wage and Hour Division (WHD) has the discretion to update such rates under 29 CFR 1.6(c)(1).

State Adopted Rate Identifiers

The "SA" identifier indicates that the classifications and prevailing wage rates set by a state (or local) government were adopted under 29 C.F.R 1.3(g)-(h). Example: SAME2023-007 01/03/2024. SA reflects that the rates are state adopted. ME refers to the State of Maine. 2023 is the year during which the state completed the survey on which the listed classifications and rates are based. The next number, 007 in the example, is an internal number used in producing the wage determination. The date, 01/03/2024 in the example, reflects the date on which the classifications and rates under the "SA" identifier took effect under state law in the state from which the rates were adopted.

WAGE DETERMINATION APPEALS PROCESS

1) Has there been an initial decision in the matter? This can be:

- a) a survey underlying a wage determination
- b) an existing published wage determination
- c) an initial WHD letter setting forth a position on a wage determination matter
- d) an initial conformance (additional classification and rate) determination

On survey related matters, initial contact, including requests for summaries of surveys, should be directed to the WHD Branch of Wage Surveys. Requests can be submitted via email to davisbaconinfo@dol.gov or by mail to:

Branch of Wage Surveys
 Wage and Hour Division
 U.S. Department of Labor
 200 Constitution Avenue, N.W.
 Washington, DC 20210

Regarding any other wage determination matter such as conformance decisions, requests for initial decisions should be directed to the WHD Branch of Construction Wage Determinations. Requests can be submitted via email to BCWD-Office@dol.gov or by mail to:

Branch of Construction Wage Determinations
 Wage and Hour Division
 U.S. Department of Labor
 200 Constitution Avenue, N.W.
 Washington, DC 20210

2) If an initial decision has been issued, then any interested party (those affected by the action) that disagrees with the decision can request review and reconsideration from the Wage and Hour Administrator (See 29 CFR Part 1.8 and 29 CFR Part 7). Requests for review and reconsideration can be submitted via email to dba.reconsideration@dol.gov or by mail to:

Wage and Hour Administrator
 U.S. Department of Labor
 200 Constitution Avenue, N.W.
 Washington, DC 20210

The request should be accompanied by a full statement of the

interested party's position and any information (wage payment data, project description, area practice material, etc.) that the requestor considers relevant to the issue.

3) If the decision of the Administrator is not favorable, an interested party may appeal directly to the Administrative Review Board (formerly the Wage Appeals Board). Write to:

Administrative Review Board
U.S. Department of Labor
200 Constitution Avenue, N.W.
Washington, DC 20210.

=====

END OF GENERAL DECISION

..

"General Decision Number: ME20260037 01/02/2026

Superseded General Decision Number: ME20250037

State: Maine

Construction Type: Highway

County: Kennebec County in Maine.

HIGHWAY CONSTRUCTION PROJECTS

Modification Number 0 Publication Date 01/02/2026

ENGI0004-005 04/01/2025

	Rates	Fringes
POWER EQUIPMENT OPERATOR: Grader/Blade, Milling Machine, Paver (Asphalt, Aggregate, and Concrete), Roller Asphalt.....	\$ 30.17	13.80

SUME2014-032 06/23/2017

	Rates	Fringes
CARPENTER, Includes Form Work....	\$ 18.34	2.84
HIGHWAY/PARKING LOT STRIPING: Laborer.....	\$ 14.80	1.27
IRONWORKER, REINFORCING.....	\$ 16.27	0.00
LABORER: Asphalt, Includes Raker, Shoveler, Spreader and Distributor.....	\$ 15.06	2.72
LABORER: Common or General.....	\$ 14.02	2.16
LABORER: Landscape.....	\$ 18.69	2.70
LABORER: Wheelman.....	\$ 15.64	4.29
OPERATOR: Backhoe/Excavator/Trackhoe.....	\$ 19.52	5.15
OPERATOR: Bobcat/Skid Steer/Skid Loader.....	\$ 21.98	4.85
OPERATOR: Broom/Sweeper.....	\$ 19.09	5.20
OPERATOR: Bulldozer.....	\$ 17.30	3.50
OPERATOR: Loader.....	\$ 18.59	5.53
OPERATOR: Mechanic.....	\$ 21.91	8.55
OPERATOR: Screed.....	\$ 19.43	4.90
OPERATOR: Roller (Earth).....	\$ 16.43	3.40

TRAFFIC CONTROL: Flagger.....\$	9.38	0.00
TRAFFIC CONTROL: Laborer-Cones/ Barricades/Barrels - Setter/Mover/Sweeper.....\$		
	17.47	4.80
TRUCK DRIVER: Dump Truck.....\$	14.32	5.81
TRUCK DRIVER: TackTruck.....\$	20.18	7.75

WELDERS - Receive rate prescribed for craft performing operation to which welding is incidental.

=====
Note: Executive Order (EO) 13706, Establishing Paid Sick Leave for Federal Contractors applies to all contracts subject to the Davis-Bacon Act for which the contract is awarded (and any solicitation was issued) on or after January 1, 2017. If this contract is covered by the EO, the contractor must provide employees with 1 hour of paid sick leave for every 30 hours they work, up to 56 hours of paid sick leave each year. Employees must be permitted to use paid sick leave for their own illness, injury or other health-related needs, including preventive care; to assist a family member (or person who is like family to the employee) who is ill, injured, or has other health-related needs, including preventive care; or for reasons resulting from, or to assist a family member (or person who is like family to the employee) who is a victim of, domestic violence, sexual assault, or stalking. Additional information on contractor requirements and worker protections under the EO is available at <https://www.dol.gov/agencies/whd/government-contracts>.

Note: Executive Order 13658 generally applies to contracts subject to the Davis-Bacon Act that were awarded on or between January 1, 2015 and January 29, 2022, and that have not been renewed or extended on or after January 30, 2022. Executive Order 13658 does not apply to contracts subject only to the Davis-Bacon Related Acts regardless of when they were awarded. If a contract is subject to Executive Order 13658, the contractor must pay all covered workers at least \$13.30 per hour (or the applicable wage rate listed on this wage determination, if it is higher) for all hours spent performing on the contract in 2025. The applicable Executive Order minimum wage rate will be adjusted annually. Additional information on contractor requirements and worker protections under Executive Order 13658 is available at www.dol.gov/whd/govcontracts.

Unlisted classifications needed for work not included within the scope of the classifications listed may be added after award only as provided in the labor standards contract clauses (29CFR 5.5 (a) (1) (iii)).

The body of each wage determination lists the classifications and wage rates that have been found to be prevailing for the type(s) of construction and geographic area covered by the wage determination. The classifications are listed in alphabetical order under rate identifiers indicating whether the particular

rate is a union rate (current union negotiated rate), a survey rate, a weighted union average rate, a state adopted rate, or a supplemental classification rate.

Union Rate Identifiers

A four-letter identifier beginning with characters other than ""SU"", ""UAVG"", ?SA?, or ?SC? denotes that a union rate was prevailing for that classification in the survey. Example: PLUM0198-005 07/01/2024. PLUM is an identifier of the union whose collectively bargained rate prevailed in the survey for this classification, which in this example would be Plumbers. 0198 indicates the local union number or district council number where applicable, i.e., Plumbers Local 0198. The next number, 005 in the example, is an internal number used in processing the wage determination. The date, 07/01/2024 in the example, is the effective date of the most current negotiated rate.

Union prevailing wage rates are updated to reflect all changes over time that are reported to WHD in the rates in the collective bargaining agreement (CBA) governing the classification.

Union Average Rate Identifiers

The UAVG identifier indicates that no single rate prevailed for those classifications, but that 100% of the data reported for the classifications reflected union rates. EXAMPLE: UAVG-OH-0010 01/01/2024. UAVG indicates that the rate is a weighted union average rate. OH indicates the State of Ohio. The next number, 0010 in the example, is an internal number used in producing the wage determination. The date, 01/01/2024 in the example, indicates the date the wage determination was updated to reflect the most current union average rate.

A UAVG rate will be updated once a year, usually in January, to reflect a weighted average of the current rates in the collective bargaining agreements on which the rate is based.

Survey Rate Identifiers

The ""SU"" identifier indicates that either a single non-union rate prevailed (as defined in 29 CFR 1.2) for this classification in the survey or that the rate was derived by computing a weighted average rate based on all the rates reported in the survey for that classification. As a weighted average rate includes all rates reported in the survey, it may include both union and non-union rates. Example: SUFL2022-007 6/27/2024. SU indicates the rate is a single non-union prevailing rate or a weighted average of survey data for that classification. FL indicates the State of Florida. 2022 is the year of the survey on which these classifications and rates are based. The next number, 007 in the example, is an internal number used in producing the wage determination. The date, 6/27/2024 in the example, indicates the survey completion date for the classifications and rates under that identifier.

?SU? wage rates typically remain in effect until a new survey is conducted. However, the Wage and Hour Division (WHD) has the discretion to update such rates under 29 CFR 1.6(c)(1).

State Adopted Rate Identifiers

The ""SA"" identifier indicates that the classifications and

prevailing wage rates set by a state (or local) government were adopted under 29 C.F.R 1.3(g)-(h). Example: SAME2023-007 01/03/2024. SA reflects that the rates are state adopted. ME refers to the State of Maine. 2023 is the year during which the state completed the survey on which the listed classifications and rates are based. The next number, 007 in the example, is an internal number used in producing the wage determination. The date, 01/03/2024 in the example, reflects the date on which the classifications and rates under the ?SA? identifier took effect under state law in the state from which the rates were adopted.

 WAGE DETERMINATION APPEALS PROCESS

1) Has there been an initial decision in the matter? This can be:

- a) a survey underlying a wage determination
- b) an existing published wage determination
- c) an initial WHD letter setting forth a position on a wage determination matter
- d) an initial conformance (additional classification and rate) determination

On survey related matters, initial contact, including requests for summaries of surveys, should be directed to the WHD Branch of Wage Surveys. Requests can be submitted via email to davisbaconinfo@dol.gov or by mail to:

Branch of Wage Surveys
 Wage and Hour Division
 U.S. Department of Labor
 200 Constitution Avenue, N.W.
 Washington, DC 20210

Regarding any other wage determination matter such as conformance decisions, requests for initial decisions should be directed to the WHD Branch of Construction Wage Determinations. Requests can be submitted via email to BCWD-Office@dol.gov or by mail to:

Branch of Construction Wage Determinations
 Wage and Hour Division
 U.S. Department of Labor
 200 Constitution Avenue, N.W.
 Washington, DC 20210

2) If an initial decision has been issued, then any interested party (those affected by the action) that disagrees with the decision can request review and reconsideration from the Wage and Hour Administrator (See 29 CFR Part 1.8 and 29 CFR Part 7). Requests for review and reconsideration can be submitted via email to dba.reconsideration@dol.gov or by mail to:

Wage and Hour Administrator
 U.S. Department of Labor
 200 Constitution Avenue, N.W.
 Washington, DC 20210

The request should be accompanied by a full statement of the interested party's position and any information (wage payment data, project description, area practice material, etc.) that the requestor considers relevant to the issue.

3) If the decision of the Administrator is not favorable, an interested party may appeal directly to the Administrative Review Board (formerly the Wage Appeals Board). Write to:

Administrative Review Board
U.S. Department of Labor
200 Constitution Avenue, N.W.
Washington, DC 20210.

=====

END OF GENERAL DECISION

..

"General Decision Number: ME20260038 01/02/2026

Superseded General Decision Number: ME20250038

State: Maine

Construction Type: Highway

County: Knox County in Maine.

HIGHWAY CONSTRUCTION PROJECTS

Modification Number 0 Publication Date 01/02/2026

ENGI0004-022 04/01/2025

	Rates	Fringes
POWER EQUIPMENT OPERATOR: Grader/Blade, Milling Machine.....	\$ 30.17	13.80

SUME2014-033 06/23/2017

	Rates	Fringes
CARPENTER, Includes Form Work....	\$ 18.34	2.84
HIGHWAY/PARKING LOT STRIPING: Laborer.....	\$ 14.80	1.27
IRONWORKER, REINFORCING.....	\$ 16.27	0.00
LABORER: Asphalt, Includes Raker, Shoveler, Spreader and Distributor.....	\$ 15.40	2.69
LABORER: Common or General.....	\$ 14.56	0.00
LABORER: Landscape.....	\$ 18.69	2.70
LABORER: Wheelman.....	\$ 15.64	4.29
OPERATOR: Backhoe/Excavator/Trackhoe.....	\$ 18.83	4.08
OPERATOR: Bobcat/Skid Steer/Skid Loader.....	\$ 21.66	4.91
OPERATOR: Broom/Sweeper.....	\$ 19.09	5.20
OPERATOR: Bulldozer.....	\$ 17.30	3.50
OPERATOR: Loader.....	\$ 18.59	5.53
OPERATOR: Mechanic.....	\$ 22.07	8.73
OPERATOR: Paver (Asphalt, Aggregate, and Concrete).....	\$ 21.46	8.78
OPERATOR: Screed.....	\$ 19.02	4.82
OPERATOR: Roller (Earth).....	\$ 16.43	3.40

OPERATOR: Roller Asphalt.....	\$ 21.97	7.81
TRAFFIC CONTROL: Flagger.....	\$ 9.38	0.00
TRAFFIC CONTROL:		
Laborer-Cones/ Barricades/Barrels - Setter/Mover/Sweeper.....		
	\$ 17.47	4.80
TRUCK DRIVER: Dump Truck.....	\$ 16.68	2.79
TRUCK DRIVER: TackTruck.....	\$ 20.18	7.75

WELDERS - Receive rate prescribed for craft performing operation to which welding is incidental.

=====

Note: Executive Order (EO) 13706, Establishing Paid Sick Leave for Federal Contractors applies to all contracts subject to the Davis-Bacon Act for which the contract is awarded (and any solicitation was issued) on or after January 1, 2017. If this contract is covered by the EO, the contractor must provide employees with 1 hour of paid sick leave for every 30 hours they work, up to 56 hours of paid sick leave each year. Employees must be permitted to use paid sick leave for their own illness, injury or other health-related needs, including preventive care; to assist a family member (or person who is like family to the employee) who is ill, injured, or has other health-related needs, including preventive care; or for reasons resulting from, or to assist a family member (or person who is like family to the employee) who is a victim of, domestic violence, sexual assault, or stalking. Additional information on contractor requirements and worker protections under the EO is available at <https://www.dol.gov/agencies/whd/government-contracts>.

Note: Executive Order 13658 generally applies to contracts subject to the Davis-Bacon Act that were awarded on or between January 1, 2015 and January 29, 2022, and that have not been renewed or extended on or after January 30, 2022. Executive Order 13658 does not apply to contracts subject only to the Davis-Bacon Related Acts regardless of when they were awarded. If a contract is subject to Executive Order 13658, the contractor must pay all covered workers at least \$13.30 per hour (or the applicable wage rate listed on this wage determination, if it is higher) for all hours spent performing on the contract in 2025. The applicable Executive Order minimum wage rate will be adjusted annually. Additional information on contractor requirements and worker protections under Executive Order 13658 is available at www.dol.gov/whd/govcontracts.

Unlisted classifications needed for work not included within the scope of the classifications listed may be added after award only as provided in the labor standards contract clauses (29CFR 5.5 (a) (1) (iii)).

The body of each wage determination lists the classifications and wage rates that have been found to be prevailing for the

type(s) of construction and geographic area covered by the wage determination. The classifications are listed in alphabetical order under rate identifiers indicating whether the particular rate is a union rate (current union negotiated rate), a survey rate, a weighted union average rate, a state adopted rate, or a supplemental classification rate.

Union Rate Identifiers

A four-letter identifier beginning with characters other than "SU", "UAVG", "SA", or "SC" denotes that a union rate was prevailing for that classification in the survey. Example: PLUM0198-005 07/01/2024. PLUM is an identifier of the union whose collectively bargained rate prevailed in the survey for this classification, which in this example would be Plumbers. 0198 indicates the local union number or district council number where applicable, i.e., Plumbers Local 0198. The next number, 005 in the example, is an internal number used in processing the wage determination. The date, 07/01/2024 in the example, is the effective date of the most current negotiated rate.

Union prevailing wage rates are updated to reflect all changes over time that are reported to WHD in the rates in the collective bargaining agreement (CBA) governing the classification.

Union Average Rate Identifiers

The UAVG identifier indicates that no single rate prevailed for those classifications, but that 100% of the data reported for the classifications reflected union rates. EXAMPLE: UAVG-OH-0010 01/01/2024. UAVG indicates that the rate is a weighted union average rate. OH indicates the State of Ohio. The next number, 0010 in the example, is an internal number used in producing the wage determination. The date, 01/01/2024 in the example, indicates the date the wage determination was updated to reflect the most current union average rate.

A UAVG rate will be updated once a year, usually in January, to reflect a weighted average of the current rates in the collective bargaining agreements on which the rate is based.

Survey Rate Identifiers

The "SU" identifier indicates that either a single non-union rate prevailed (as defined in 29 CFR 1.2) for this classification in the survey or that the rate was derived by computing a weighted average rate based on all the rates reported in the survey for that classification. As a weighted average rate includes all rates reported in the survey, it may include both union and non-union rates. Example: SUFL2022-007 6/27/2024. SU indicates the rate is a single non-union prevailing rate or a weighted average of survey data for that classification. FL indicates the State of Florida. 2022 is the year of the survey on which these classifications and rates are based. The next number, 007 in the example, is an internal number used in producing the wage determination. The date, 6/27/2024 in the example, indicates the survey completion date for the classifications and rates under that identifier.

"SU" wage rates typically remain in effect until a new survey is conducted. However, the Wage and Hour Division (WHD) has the discretion to update such rates under 29 CFR 1.6(c)(1).

State Adopted Rate Identifiers

The ""SA"" identifier indicates that the classifications and prevailing wage rates set by a state (or local) government were adopted under 29 C.F.R 1.3(g)-(h). Example: SAME2023-007 01/03/2024. SA reflects that the rates are state adopted. ME refers to the State of Maine. 2023 is the year during which the state completed the survey on which the listed classifications and rates are based. The next number, 007 in the example, is an internal number used in producing the wage determination. The date, 01/03/2024 in the example, reflects the date on which the classifications and rates under the ?SA? identifier took effect under state law in the state from which the rates were adopted.

WAGE DETERMINATION APPEALS PROCESS

1) Has there been an initial decision in the matter? This can be:

- a) a survey underlying a wage determination
- b) an existing published wage determination
- c) an initial WHD letter setting forth a position on a wage determination matter
- d) an initial conformance (additional classification and rate) determination

On survey related matters, initial contact, including requests for summaries of surveys, should be directed to the WHD Branch of Wage Surveys. Requests can be submitted via email to davisbaconinfo@dol.gov or by mail to:

Branch of Wage Surveys
 Wage and Hour Division
 U.S. Department of Labor
 200 Constitution Avenue, N.W.
 Washington, DC 20210

Regarding any other wage determination matter such as conformance decisions, requests for initial decisions should be directed to the WHD Branch of Construction Wage Determinations. Requests can be submitted via email to BCWD-Office@dol.gov or by mail to:

Branch of Construction Wage Determinations
 Wage and Hour Division
 U.S. Department of Labor
 200 Constitution Avenue, N.W.
 Washington, DC 20210

2) If an initial decision has been issued, then any interested party (those affected by the action) that disagrees with the decision can request review and reconsideration from the Wage and Hour Administrator (See 29 CFR Part 1.8 and 29 CFR Part 7). Requests for review and reconsideration can be submitted via email to dba.reconsideration@dol.gov or by mail to:

Wage and Hour Administrator
 U.S. Department of Labor
 200 Constitution Avenue, N.W.
 Washington, DC 20210

The request should be accompanied by a full statement of the

interested party's position and any information (wage payment data, project description, area practice material, etc.) that the requestor considers relevant to the issue.

3) If the decision of the Administrator is not favorable, an interested party may appeal directly to the Administrative Review Board (formerly the Wage Appeals Board). Write to:

Administrative Review Board
U.S. Department of Labor
200 Constitution Avenue, N.W.
Washington, DC 20210.

=====

END OF GENERAL DECISION

..

"General Decision Number: ME20260039 01/02/2026

Superseded General Decision Number: ME20250039

State: Maine

Construction Type: Highway

County: Lincoln County in Maine.

HIGHWAY CONSTRUCTION PROJECTS

Modification Number 0 Publication Date 01/02/2026

ENGI0004-022 04/01/2025

	Rates	Fringes
POWER EQUIPMENT OPERATOR: Grader/Blade, Milling Machine.....	\$ 30.17	13.80

SUME2014-034 06/23/2017

	Rates	Fringes
CARPENTER, Includes Form Work....	\$ 18.34	2.84
HIGHWAY/PARKING LOT STRIPING: Laborer.....	\$ 14.80	1.27
IRONWORKER, REINFORCING.....	\$ 16.27	0.00
LABORER: Asphalt, Includes Raker, Shoveler, Spreader and Distributor.....	\$ 15.40	2.69
LABORER: Common or General.....	\$ 15.47	2.13
LABORER: Landscape.....	\$ 18.69	2.70
LABORER: Wheelman.....	\$ 15.64	4.29
OPERATOR: Backhoe/Excavator/Trackhoe.....	\$ 18.80	4.16
OPERATOR: Bobcat/Skid Steer/Skid Loader.....	\$ 21.66	4.91
OPERATOR: Broom/Sweeper.....	\$ 19.09	5.20
OPERATOR: Bulldozer.....	\$ 17.30	3.50
OPERATOR: Loader.....	\$ 18.59	5.53
OPERATOR: Mechanic.....	\$ 22.07	8.73
OPERATOR: Paver (Asphalt, Aggregate, and Concrete).....	\$ 21.46	8.78
OPERATOR: Screed.....	\$ 19.02	4.82
OPERATOR: Roller (Earth).....	\$ 16.43	3.40

OPERATOR: Roller Asphalt.....	\$ 21.97	7.81
TRAFFIC CONTROL: Flagger.....	\$ 9.38	0.00
TRAFFIC CONTROL:		
Laborer-Cones/ Barricades/Barrels - Setter/Mover/Sweeper.....		
	\$ 17.47	4.80
TRUCK DRIVER: Dump Truck.....	\$ 15.07	5.15
TRUCK DRIVER: TackTruck.....	\$ 20.18	7.75

WELDERS - Receive rate prescribed for craft performing operation to which welding is incidental.

=====

Note: Executive Order (EO) 13706, Establishing Paid Sick Leave for Federal Contractors applies to all contracts subject to the Davis-Bacon Act for which the contract is awarded (and any solicitation was issued) on or after January 1, 2017. If this contract is covered by the EO, the contractor must provide employees with 1 hour of paid sick leave for every 30 hours they work, up to 56 hours of paid sick leave each year. Employees must be permitted to use paid sick leave for their own illness, injury or other health-related needs, including preventive care; to assist a family member (or person who is like family to the employee) who is ill, injured, or has other health-related needs, including preventive care; or for reasons resulting from, or to assist a family member (or person who is like family to the employee) who is a victim of, domestic violence, sexual assault, or stalking. Additional information on contractor requirements and worker protections under the EO is available at <https://www.dol.gov/agencies/whd/government-contracts>.

Note: Executive Order 13658 generally applies to contracts subject to the Davis-Bacon Act that were awarded on or between January 1, 2015 and January 29, 2022, and that have not been renewed or extended on or after January 30, 2022. Executive Order 13658 does not apply to contracts subject only to the Davis-Bacon Related Acts regardless of when they were awarded. If a contract is subject to Executive Order 13658, the contractor must pay all covered workers at least \$13.30 per hour (or the applicable wage rate listed on this wage determination, if it is higher) for all hours spent performing on the contract in 2025. The applicable Executive Order minimum wage rate will be adjusted annually. Additional information on contractor requirements and worker protections under Executive Order 13658 is available at www.dol.gov/whd/govcontracts.

Unlisted classifications needed for work not included within the scope of the classifications listed may be added after award only as provided in the labor standards contract clauses (29CFR 5.5 (a) (1) (iii)).

The body of each wage determination lists the classifications and wage rates that have been found to be prevailing for the

type(s) of construction and geographic area covered by the wage determination. The classifications are listed in alphabetical order under rate identifiers indicating whether the particular rate is a union rate (current union negotiated rate), a survey rate, a weighted union average rate, a state adopted rate, or a supplemental classification rate.

Union Rate Identifiers

A four-letter identifier beginning with characters other than "SU", "UAVG", "SA", or "SC" denotes that a union rate was prevailing for that classification in the survey. Example: PLUM0198-005 07/01/2024. PLUM is an identifier of the union whose collectively bargained rate prevailed in the survey for this classification, which in this example would be Plumbers. 0198 indicates the local union number or district council number where applicable, i.e., Plumbers Local 0198. The next number, 005 in the example, is an internal number used in processing the wage determination. The date, 07/01/2024 in the example, is the effective date of the most current negotiated rate.

Union prevailing wage rates are updated to reflect all changes over time that are reported to WHD in the rates in the collective bargaining agreement (CBA) governing the classification.

Union Average Rate Identifiers

The UAVG identifier indicates that no single rate prevailed for those classifications, but that 100% of the data reported for the classifications reflected union rates. EXAMPLE: UAVG-OH-0010 01/01/2024. UAVG indicates that the rate is a weighted union average rate. OH indicates the State of Ohio. The next number, 0010 in the example, is an internal number used in producing the wage determination. The date, 01/01/2024 in the example, indicates the date the wage determination was updated to reflect the most current union average rate.

A UAVG rate will be updated once a year, usually in January, to reflect a weighted average of the current rates in the collective bargaining agreements on which the rate is based.

Survey Rate Identifiers

The "SU" identifier indicates that either a single non-union rate prevailed (as defined in 29 CFR 1.2) for this classification in the survey or that the rate was derived by computing a weighted average rate based on all the rates reported in the survey for that classification. As a weighted average rate includes all rates reported in the survey, it may include both union and non-union rates. Example: SUFL2022-007 6/27/2024. SU indicates the rate is a single non-union prevailing rate or a weighted average of survey data for that classification. FL indicates the State of Florida. 2022 is the year of the survey on which these classifications and rates are based. The next number, 007 in the example, is an internal number used in producing the wage determination. The date, 6/27/2024 in the example, indicates the survey completion date for the classifications and rates under that identifier.

"SU" wage rates typically remain in effect until a new survey is conducted. However, the Wage and Hour Division (WHD) has the discretion to update such rates under 29 CFR 1.6(c)(1).

State Adopted Rate Identifiers

The ""SA"" identifier indicates that the classifications and prevailing wage rates set by a state (or local) government were adopted under 29 C.F.R 1.3(g)-(h). Example: SAME2023-007 01/03/2024. SA reflects that the rates are state adopted. ME refers to the State of Maine. 2023 is the year during which the state completed the survey on which the listed classifications and rates are based. The next number, 007 in the example, is an internal number used in producing the wage determination. The date, 01/03/2024 in the example, reflects the date on which the classifications and rates under the ?SA? identifier took effect under state law in the state from which the rates were adopted.

WAGE DETERMINATION APPEALS PROCESS

1) Has there been an initial decision in the matter? This can be:

- a) a survey underlying a wage determination
- b) an existing published wage determination
- c) an initial WHD letter setting forth a position on a wage determination matter
- d) an initial conformance (additional classification and rate) determination

On survey related matters, initial contact, including requests for summaries of surveys, should be directed to the WHD Branch of Wage Surveys. Requests can be submitted via email to davisbaconinfo@dol.gov or by mail to:

Branch of Wage Surveys
 Wage and Hour Division
 U.S. Department of Labor
 200 Constitution Avenue, N.W.
 Washington, DC 20210

Regarding any other wage determination matter such as conformance decisions, requests for initial decisions should be directed to the WHD Branch of Construction Wage Determinations. Requests can be submitted via email to BCWD-Office@dol.gov or by mail to:

Branch of Construction Wage Determinations
 Wage and Hour Division
 U.S. Department of Labor
 200 Constitution Avenue, N.W.
 Washington, DC 20210

2) If an initial decision has been issued, then any interested party (those affected by the action) that disagrees with the decision can request review and reconsideration from the Wage and Hour Administrator (See 29 CFR Part 1.8 and 29 CFR Part 7). Requests for review and reconsideration can be submitted via email to dba.reconsideration@dol.gov or by mail to:

Wage and Hour Administrator
 U.S. Department of Labor
 200 Constitution Avenue, N.W.
 Washington, DC 20210

The request should be accompanied by a full statement of the

interested party's position and any information (wage payment data, project description, area practice material, etc.) that the requestor considers relevant to the issue.

3) If the decision of the Administrator is not favorable, an interested party may appeal directly to the Administrative Review Board (formerly the Wage Appeals Board). Write to:

Administrative Review Board
U.S. Department of Labor
200 Constitution Avenue, N.W.
Washington, DC 20210.

=====

END OF GENERAL DECISION

..

"General Decision Number: ME20260040 01/02/2026

Superseded General Decision Number: ME20250040

State: Maine

Construction Type: Highway

County: Oxford County in Maine.

HIGHWAY CONSTRUCTION PROJECTS

Modification Number 0 Publication Date 01/02/2026

ENGI0004-022 04/01/2025

	Rates	Fringes
POWER EQUIPMENT OPERATOR: Grader/Blade, Milling Machine.....	\$ 30.17	13.80

SUME2014-035 06/23/2017

	Rates	Fringes
CARPENTER, Includes Form Work....	\$ 18.34	2.84
HIGHWAY/PARKING LOT STRIPING: Laborer.....	\$ 14.80	1.27
IRONWORKER, REINFORCING.....	\$ 16.27	0.00
LABORER: Asphalt, Includes Raker, Shoveler, Spreader and Distributor.....	\$ 15.40	2.69
LABORER: Common or General.....	\$ 15.83	1.99
LABORER: Landscape.....	\$ 18.69	2.70
LABORER: Wheelman.....	\$ 15.64	4.29
OPERATOR: Backhoe/Excavator/Trackhoe.....	\$ 18.80	4.16
OPERATOR: Bobcat/Skid Steer/Skid Loader.....	\$ 20.38	1.66
OPERATOR: Broom/Sweeper.....	\$ 19.09	5.20
OPERATOR: Bulldozer.....	\$ 17.30	3.50
OPERATOR: Loader.....	\$ 18.59	5.53
OPERATOR: Mechanic.....	\$ 22.07	8.73
OPERATOR: Paver (Asphalt, Aggregate, and Concrete).....	\$ 21.46	8.78
OPERATOR: Screed.....	\$ 19.02	4.82
OPERATOR: Roller (Earth).....	\$ 16.43	3.40

OPERATOR: Roller Asphalt.....	\$ 24.16	3.55
TRAFFIC CONTROL: Flagger.....	\$ 9.38	0.00
TRAFFIC CONTROL:		
Laborer-Cones/ Barricades/Barrels - Setter/Mover/Sweeper.....		
	\$ 17.47	4.80
TRUCK DRIVER: Dump Truck.....	\$ 15.83	1.16
TRUCK DRIVER: TackTruck.....	\$ 20.18	7.75

WELDERS - Receive rate prescribed for craft performing operation to which welding is incidental.

=====

Note: Executive Order (EO) 13706, Establishing Paid Sick Leave for Federal Contractors applies to all contracts subject to the Davis-Bacon Act for which the contract is awarded (and any solicitation was issued) on or after January 1, 2017. If this contract is covered by the EO, the contractor must provide employees with 1 hour of paid sick leave for every 30 hours they work, up to 56 hours of paid sick leave each year. Employees must be permitted to use paid sick leave for their own illness, injury or other health-related needs, including preventive care; to assist a family member (or person who is like family to the employee) who is ill, injured, or has other health-related needs, including preventive care; or for reasons resulting from, or to assist a family member (or person who is like family to the employee) who is a victim of, domestic violence, sexual assault, or stalking. Additional information on contractor requirements and worker protections under the EO is available at <https://www.dol.gov/agencies/whd/government-contracts>.

Note: Executive Order 13658 generally applies to contracts subject to the Davis-Bacon Act that were awarded on or between January 1, 2015 and January 29, 2022, and that have not been renewed or extended on or after January 30, 2022. Executive Order 13658 does not apply to contracts subject only to the Davis-Bacon Related Acts regardless of when they were awarded. If a contract is subject to Executive Order 13658, the contractor must pay all covered workers at least \$13.30 per hour (or the applicable wage rate listed on this wage determination, if it is higher) for all hours spent performing on the contract in 2025. The applicable Executive Order minimum wage rate will be adjusted annually. Additional information on contractor requirements and worker protections under Executive Order 13658 is available at www.dol.gov/whd/govcontracts.

Unlisted classifications needed for work not included within the scope of the classifications listed may be added after award only as provided in the labor standards contract clauses (29CFR 5.5 (a) (1) (iii)).

The body of each wage determination lists the classifications and wage rates that have been found to be prevailing for the

type(s) of construction and geographic area covered by the wage determination. The classifications are listed in alphabetical order under rate identifiers indicating whether the particular rate is a union rate (current union negotiated rate), a survey rate, a weighted union average rate, a state adopted rate, or a supplemental classification rate.

Union Rate Identifiers

A four-letter identifier beginning with characters other than "SU", "UAVG", "SA", or "SC" denotes that a union rate was prevailing for that classification in the survey. Example: PLUM0198-005 07/01/2024. PLUM is an identifier of the union whose collectively bargained rate prevailed in the survey for this classification, which in this example would be Plumbers. 0198 indicates the local union number or district council number where applicable, i.e., Plumbers Local 0198. The next number, 005 in the example, is an internal number used in processing the wage determination. The date, 07/01/2024 in the example, is the effective date of the most current negotiated rate.

Union prevailing wage rates are updated to reflect all changes over time that are reported to WHD in the rates in the collective bargaining agreement (CBA) governing the classification.

Union Average Rate Identifiers

The UAVG identifier indicates that no single rate prevailed for those classifications, but that 100% of the data reported for the classifications reflected union rates. EXAMPLE: UAVG-OH-0010 01/01/2024. UAVG indicates that the rate is a weighted union average rate. OH indicates the State of Ohio. The next number, 0010 in the example, is an internal number used in producing the wage determination. The date, 01/01/2024 in the example, indicates the date the wage determination was updated to reflect the most current union average rate.

A UAVG rate will be updated once a year, usually in January, to reflect a weighted average of the current rates in the collective bargaining agreements on which the rate is based.

Survey Rate Identifiers

The "SU" identifier indicates that either a single non-union rate prevailed (as defined in 29 CFR 1.2) for this classification in the survey or that the rate was derived by computing a weighted average rate based on all the rates reported in the survey for that classification. As a weighted average rate includes all rates reported in the survey, it may include both union and non-union rates. Example: SUFL2022-007 6/27/2024. SU indicates the rate is a single non-union prevailing rate or a weighted average of survey data for that classification. FL indicates the State of Florida. 2022 is the year of the survey on which these classifications and rates are based. The next number, 007 in the example, is an internal number used in producing the wage determination. The date, 6/27/2024 in the example, indicates the survey completion date for the classifications and rates under that identifier.

"SU" wage rates typically remain in effect until a new survey is conducted. However, the Wage and Hour Division (WHD) has the discretion to update such rates under 29 CFR 1.6(c)(1).

State Adopted Rate Identifiers

The ""SA"" identifier indicates that the classifications and prevailing wage rates set by a state (or local) government were adopted under 29 C.F.R 1.3(g)-(h). Example: SAME2023-007 01/03/2024. SA reflects that the rates are state adopted. ME refers to the State of Maine. 2023 is the year during which the state completed the survey on which the listed classifications and rates are based. The next number, 007 in the example, is an internal number used in producing the wage determination. The date, 01/03/2024 in the example, reflects the date on which the classifications and rates under the ?SA? identifier took effect under state law in the state from which the rates were adopted.

WAGE DETERMINATION APPEALS PROCESS

1) Has there been an initial decision in the matter? This can be:

- a) a survey underlying a wage determination
- b) an existing published wage determination
- c) an initial WHD letter setting forth a position on a wage determination matter
- d) an initial conformance (additional classification and rate) determination

On survey related matters, initial contact, including requests for summaries of surveys, should be directed to the WHD Branch of Wage Surveys. Requests can be submitted via email to davisbaconinfo@dol.gov or by mail to:

Branch of Wage Surveys
 Wage and Hour Division
 U.S. Department of Labor
 200 Constitution Avenue, N.W.
 Washington, DC 20210

Regarding any other wage determination matter such as conformance decisions, requests for initial decisions should be directed to the WHD Branch of Construction Wage Determinations. Requests can be submitted via email to BCWD-Office@dol.gov or by mail to:

Branch of Construction Wage Determinations
 Wage and Hour Division
 U.S. Department of Labor
 200 Constitution Avenue, N.W.
 Washington, DC 20210

2) If an initial decision has been issued, then any interested party (those affected by the action) that disagrees with the decision can request review and reconsideration from the Wage and Hour Administrator (See 29 CFR Part 1.8 and 29 CFR Part 7). Requests for review and reconsideration can be submitted via email to dba.reconsideration@dol.gov or by mail to:

Wage and Hour Administrator
 U.S. Department of Labor
 200 Constitution Avenue, N.W.
 Washington, DC 20210

The request should be accompanied by a full statement of the

interested party's position and any information (wage payment data, project description, area practice material, etc.) that the requestor considers relevant to the issue.

3) If the decision of the Administrator is not favorable, an interested party may appeal directly to the Administrative Review Board (formerly the Wage Appeals Board). Write to:

Administrative Review Board
U.S. Department of Labor
200 Constitution Avenue, N.W.
Washington, DC 20210.

=====

END OF GENERAL DECISION

..

"General Decision Number: ME20260041 01/02/2026

Superseded General Decision Number: ME20250041

State: Maine

Construction Type: Highway

County: Piscataquis County in Maine.

HIGHWAY CONSTRUCTION PROJECTS

Modification Number 0 Publication Date 01/02/2026

ENGI0004-005 04/01/2025

	Rates	Fringes
POWER EQUIPMENT OPERATOR: Grader/Blade, Milling Machine, Paver (Asphalt, Aggregate, and Concrete), Roller Asphalt.....	\$ 30.17	13.80

SUME2014-036 06/23/2017

	Rates	Fringes
CARPENTER, Includes Form Work....	\$ 18.34	2.84
HIGHWAY/PARKING LOT STRIPING: Laborer.....	\$ 15.81	3.24
IRONWORKER, REINFORCING.....	\$ 16.27	0.00
LABORER: Asphalt, Includes Raker, Shoveler, Spreader and Distributor.....	\$ 14.32	3.17
LABORER: Common or General.....	\$ 13.46	1.38
LABORER: Wheelman.....	\$ 15.40	3.01
OPERATOR: Backhoe/Excavator/Trackhoe.....	\$ 15.18	3.07
OPERATOR: Bobcat/Skid Steer/Skid Loader.....	\$ 20.36	5.06
OPERATOR: Broom/Sweeper.....	\$ 16.75	6.47
OPERATOR: Bulldozer.....	\$ 16.58	2.89
OPERATOR: Loader.....	\$ 17.18	4.72
OPERATOR: Mechanic.....	\$ 22.30	8.71
OPERATOR: Screed.....	\$ 18.82	4.75
OPERATOR: Roller (Earth).....	\$ 15.81	1.72
TRAFFIC CONTROL: Flagger.....	\$ 9.00	0.00

TRAFFIC CONTROL:

Laborer-Cones/ Barricades/Barrels -		
Setter/Mover/Sweeper.....\$ 17.48		5.37
TRUCK DRIVER: Dump Truck.....\$ 14.35		6.33
TRUCK DRIVER: TackTruck.....\$ 18.82		8.29

WELDERS - Receive rate prescribed for craft performing operation to which welding is incidental.

=====
Note: Executive Order (EO) 13706, Establishing Paid Sick Leave for Federal Contractors applies to all contracts subject to the Davis-Bacon Act for which the contract is awarded (and any solicitation was issued) on or after January 1, 2017. If this contract is covered by the EO, the contractor must provide employees with 1 hour of paid sick leave for every 30 hours they work, up to 56 hours of paid sick leave each year. Employees must be permitted to use paid sick leave for their own illness, injury or other health-related needs, including preventive care; to assist a family member (or person who is like family to the employee) who is ill, injured, or has other health-related needs, including preventive care; or for reasons resulting from, or to assist a family member (or person who is like family to the employee) who is a victim of, domestic violence, sexual assault, or stalking. Additional information on contractor requirements and worker protections under the EO is available at <https://www.dol.gov/agencies/whd/government-contracts>.

Note: Executive Order 13658 generally applies to contracts subject to the Davis-Bacon Act that were awarded on or between January 1, 2015 and January 29, 2022, and that have not been renewed or extended on or after January 30, 2022. Executive Order 13658 does not apply to contracts subject only to the Davis-Bacon Related Acts regardless of when they were awarded. If a contract is subject to Executive Order 13658, the contractor must pay all covered workers at least \$13.30 per hour (or the applicable wage rate listed on this wage determination, if it is higher) for all hours spent performing on the contract in 2025. The applicable Executive Order minimum wage rate will be adjusted annually. Additional information on contractor requirements and worker protections under Executive Order 13658 is available at www.dol.gov/whd/govcontracts.

Unlisted classifications needed for work not included within the scope of the classifications listed may be added after award only as provided in the labor standards contract clauses (29CFR 5.5 (a) (1) (iii)).

The body of each wage determination lists the classifications and wage rates that have been found to be prevailing for the type(s) of construction and geographic area covered by the wage determination. The classifications are listed in alphabetical order under rate identifiers indicating whether the particular rate is a union rate (current union negotiated rate), a survey rate, a weighted union average rate, a state adopted rate, or a

supplemental classification rate.

Union Rate Identifiers

A four-letter identifier beginning with characters other than "SU", "UAVG", ?SA?, or ?SC? denotes that a union rate was prevailing for that classification in the survey. Example: PLUM0198-005 07/01/2024. PLUM is an identifier of the union whose collectively bargained rate prevailed in the survey for this classification, which in this example would be Plumbers. 0198 indicates the local union number or district council number where applicable, i.e., Plumbers Local 0198. The next number, 005 in the example, is an internal number used in processing the wage determination. The date, 07/01/2024 in the example, is the effective date of the most current negotiated rate.

Union prevailing wage rates are updated to reflect all changes over time that are reported to WHD in the rates in the collective bargaining agreement (CBA) governing the classification.

Union Average Rate Identifiers

The UAVG identifier indicates that no single rate prevailed for those classifications, but that 100% of the data reported for the classifications reflected union rates. EXAMPLE: UAVG-OH-0010 01/01/2024. UAVG indicates that the rate is a weighted union average rate. OH indicates the State of Ohio. The next number, 0010 in the example, is an internal number used in producing the wage determination. The date, 01/01/2024 in the example, indicates the date the wage determination was updated to reflect the most current union average rate.

A UAVG rate will be updated once a year, usually in January, to reflect a weighted average of the current rates in the collective bargaining agreements on which the rate is based.

Survey Rate Identifiers

The "SU" identifier indicates that either a single non-union rate prevailed (as defined in 29 CFR 1.2) for this classification in the survey or that the rate was derived by computing a weighted average rate based on all the rates reported in the survey for that classification. As a weighted average rate includes all rates reported in the survey, it may include both union and non-union rates. Example: SUFL2022-007 6/27/2024. SU indicates the rate is a single non-union prevailing rate or a weighted average of survey data for that classification. FL indicates the State of Florida. 2022 is the year of the survey on which these classifications and rates are based. The next number, 007 in the example, is an internal number used in producing the wage determination. The date, 6/27/2024 in the example, indicates the survey completion date for the classifications and rates under that identifier.

?SU? wage rates typically remain in effect until a new survey is conducted. However, the Wage and Hour Division (WHD) has the discretion to update such rates under 29 CFR 1.6(c)(1).

State Adopted Rate Identifiers

The "SA" identifier indicates that the classifications and prevailing wage rates set by a state (or local) government were adopted under 29 C.F.R 1.3(g)-(h). Example: SAME2023-007

01/03/2024. SA reflects that the rates are state adopted. ME refers to the State of Maine. 2023 is the year during which the state completed the survey on which the listed classifications and rates are based. The next number, 007 in the example, is an internal number used in producing the wage determination. The date, 01/03/2024 in the example, reflects the date on which the classifications and rates under the ?SA? identifier took effect under state law in the state from which the rates were adopted.

WAGE DETERMINATION APPEALS PROCESS

1) Has there been an initial decision in the matter? This can be:

- a) a survey underlying a wage determination
- b) an existing published wage determination
- c) an initial WHD letter setting forth a position on a wage determination matter
- d) an initial conformance (additional classification and rate) determination

On survey related matters, initial contact, including requests for summaries of surveys, should be directed to the WHD Branch of Wage Surveys. Requests can be submitted via email to davisbaconinfo@dol.gov or by mail to:

Branch of Wage Surveys
 Wage and Hour Division
 U.S. Department of Labor
 200 Constitution Avenue, N.W.
 Washington, DC 20210

Regarding any other wage determination matter such as conformance decisions, requests for initial decisions should be directed to the WHD Branch of Construction Wage Determinations. Requests can be submitted via email to BCWD-Office@dol.gov or by mail to:

Branch of Construction Wage Determinations
 Wage and Hour Division
 U.S. Department of Labor
 200 Constitution Avenue, N.W.
 Washington, DC 20210

2) If an initial decision has been issued, then any interested party (those affected by the action) that disagrees with the decision can request review and reconsideration from the Wage and Hour Administrator (See 29 CFR Part 1.8 and 29 CFR Part 7). Requests for review and reconsideration can be submitted via email to dba.reconsideration@dol.gov or by mail to:

Wage and Hour Administrator
 U.S. Department of Labor
 200 Constitution Avenue, N.W.
 Washington, DC 20210

The request should be accompanied by a full statement of the interested party's position and any information (wage payment data, project description, area practice material, etc.) that the requestor considers relevant to the issue.

3) If the decision of the Administrator is not favorable, an

interested party may appeal directly to the Administrative Review Board (formerly the Wage Appeals Board). Write to:

Administrative Review Board
U.S. Department of Labor
200 Constitution Avenue, N.W.
Washington, DC 20210.

=====

END OF GENERAL DECISION

..

"General Decision Number: ME20260048 01/02/2026

Superseded General Decision Number: ME20250048

State: Maine

Construction Type: Highway

County: Sagadahoc County in Maine.

HIGHWAY CONSTRUCTION PROJECTS

Modification Number 0 Publication Date 01/02/2026

SUME2014-043 06/23/2017

	Rates	Fringes
CARPENTER, Includes Form Work....	\$ 18.95	3.23
CEMENT MASON/CONCRETE FINISHER...	\$ 19.27	1.13
ELECTRICIAN.....	\$ 25.21	5.63
HIGHWAY/PARKING LOT STRIPING: Laborer.....	\$ 15.53	2.04
INSTALLER - GUARDRAIL.....	\$ 19.98	2.55
IRONWORKER, REINFORCING.....	\$ 21.85	0.00
IRONWORKER, STRUCTURAL.....	\$ 22.33	4.50
LABORER: Asphalt, Includes Raker, Shoveler, Spreader and Distributor.....	\$ 17.30	1.76
LABORER: Common or General.....	\$ 15.06	2.09
LABORER: Epoxy Injector (Concrete).....	\$ 13.43	1.15
LABORER: Wheelman.....	\$ 21.28	4.02
OPERATOR: Backhoe/Excavator/Trackhoe.....	\$ 20.67	3.91
OPERATOR: Bobcat/Skid Steer/Skid Loader.....	\$ 22.21	1.90
OPERATOR: Broom/Sweeper.....	\$ 19.02	0.00
OPERATOR: Bulldozer.....	\$ 21.71	5.67
OPERATOR: Grader/Blade.....	\$ 27.40	8.13
OPERATOR: Loader.....	\$ 19.52	3.19
OPERATOR: Mechanic.....	\$ 24.69	8.18
OPERATOR: Milling Machine.....	\$ 28.51	5.44
OPERATOR: Paver (Asphalt,		

Aggregate, and Concrete).....\$ 20.26	4.61
OPERATOR: Roller (Earth).....\$ 16.52	1.66
OPERATOR: Roller Asphalt.....\$ 19.38	4.59
TRAFFIC CONTROL: Flagger.....\$ 10.33	0.00
TRAFFIC CONTROL: Laborer-Cones/ Barricades/Barrels - Setter/Mover/Sweeper.....\$ 17.02	
TRUCK DRIVER: Dump Truck.....\$ 17.27	2.62

WELDERS - Receive rate prescribed for craft performing operation to which welding is incidental.

=====

Note: Executive Order (EO) 13706, Establishing Paid Sick Leave for Federal Contractors applies to all contracts subject to the Davis-Bacon Act for which the contract is awarded (and any solicitation was issued) on or after January 1, 2017. If this contract is covered by the EO, the contractor must provide employees with 1 hour of paid sick leave for every 30 hours they work, up to 56 hours of paid sick leave each year. Employees must be permitted to use paid sick leave for their own illness, injury or other health-related needs, including preventive care; to assist a family member (or person who is like family to the employee) who is ill, injured, or has other health-related needs, including preventive care; or for reasons resulting from, or to assist a family member (or person who is like family to the employee) who is a victim of, domestic violence, sexual assault, or stalking. Additional information on contractor requirements and worker protections under the EO is available at <https://www.dol.gov/agencies/whd/government-contracts>.

Note: Executive Order 13658 generally applies to contracts subject to the Davis-Bacon Act that were awarded on or between January 1, 2015 and January 29, 2022, and that have not been renewed or extended on or after January 30, 2022. Executive Order 13658 does not apply to contracts subject only to the Davis-Bacon Related Acts regardless of when they were awarded. If a contract is subject to Executive Order 13658, the contractor must pay all covered workers at least \$13.30 per hour (or the applicable wage rate listed on this wage determination, if it is higher) for all hours spent performing on the contract in 2025. The applicable Executive Order minimum wage rate will be adjusted annually. Additional information on contractor requirements and worker protections under Executive Order 13658 is available at www.dol.gov/whd/govcontracts.

Unlisted classifications needed for work not included within the scope of the classifications listed may be added after award only as provided in the labor standards contract clauses (29CFR 5.5 (a) (1) (iii)).

The body of each wage determination lists the classifications

and wage rates that have been found to be prevailing for the type(s) of construction and geographic area covered by the wage determination. The classifications are listed in alphabetical order under rate identifiers indicating whether the particular rate is a union rate (current union negotiated rate), a survey rate, a weighted union average rate, a state adopted rate, or a supplemental classification rate.

Union Rate Identifiers

A four-letter identifier beginning with characters other than ""SU"", ""UAVG"", ?SA?, or ?SC? denotes that a union rate was prevailing for that classification in the survey. Example: PLUM0198-005 07/01/2024. PLUM is an identifier of the union whose collectively bargained rate prevailed in the survey for this classification, which in this example would be Plumbers. 0198 indicates the local union number or district council number where applicable, i.e., Plumbers Local 0198. The next number, 005 in the example, is an internal number used in processing the wage determination. The date, 07/01/2024 in the example, is the effective date of the most current negotiated rate.

Union prevailing wage rates are updated to reflect all changes over time that are reported to WHD in the rates in the collective bargaining agreement (CBA) governing the classification.

Union Average Rate Identifiers

The UAVG identifier indicates that no single rate prevailed for those classifications, but that 100% of the data reported for the classifications reflected union rates. EXAMPLE: UAVG-OH-0010 01/01/2024. UAVG indicates that the rate is a weighted union average rate. OH indicates the State of Ohio. The next number, 0010 in the example, is an internal number used in producing the wage determination. The date, 01/01/2024 in the example, indicates the date the wage determination was updated to reflect the most current union average rate.

A UAVG rate will be updated once a year, usually in January, to reflect a weighted average of the current rates in the collective bargaining agreements on which the rate is based.

Survey Rate Identifiers

The ""SU"" identifier indicates that either a single non-union rate prevailed (as defined in 29 CFR 1.2) for this classification in the survey or that the rate was derived by computing a weighted average rate based on all the rates reported in the survey for that classification. As a weighted average rate includes all rates reported in the survey, it may include both union and non-union rates. Example: SUFL2022-007 6/27/2024. SU indicates the rate is a single non-union prevailing rate or a weighted average of survey data for that classification. FL indicates the State of Florida. 2022 is the year of the survey on which these classifications and rates are based. The next number, 007 in the example, is an internal number used in producing the wage determination. The date, 6/27/2024 in the example, indicates the survey completion date for the classifications and rates under that identifier.

?SU? wage rates typically remain in effect until a new survey is conducted. However, the Wage and Hour Division (WHD) has the discretion to update such rates under 29 CFR 1.6(c)(1).

State Adopted Rate Identifiers

The ""SA"" identifier indicates that the classifications and prevailing wage rates set by a state (or local) government were adopted under 29 C.F.R 1.3(g)-(h). Example: SAME2023-007 01/03/2024. SA reflects that the rates are state adopted. ME refers to the State of Maine. 2023 is the year during which the state completed the survey on which the listed classifications and rates are based. The next number, 007 in the example, is an internal number used in producing the wage determination. The date, 01/03/2024 in the example, reflects the date on which the classifications and rates under the ?SA? identifier took effect under state law in the state from which the rates were adopted.

WAGE DETERMINATION APPEALS PROCESS

1) Has there been an initial decision in the matter? This can be:

- a) a survey underlying a wage determination
- b) an existing published wage determination
- c) an initial WHD letter setting forth a position on a wage determination matter
- d) an initial conformance (additional classification and rate) determination

On survey related matters, initial contact, including requests for summaries of surveys, should be directed to the WHD Branch of Wage Surveys. Requests can be submitted via email to davisbaconinfo@dol.gov or by mail to:

Branch of Wage Surveys
Wage and Hour Division
U.S. Department of Labor
200 Constitution Avenue, N.W.
Washington, DC 20210

Regarding any other wage determination matter such as conformance decisions, requests for initial decisions should be directed to the WHD Branch of Construction Wage Determinations. Requests can be submitted via email to BCWD-Office@dol.gov or by mail to:

Branch of Construction Wage Determinations
Wage and Hour Division
U.S. Department of Labor
200 Constitution Avenue, N.W.
Washington, DC 20210

2) If an initial decision has been issued, then any interested party (those affected by the action) that disagrees with the decision can request review and reconsideration from the Wage and Hour Administrator (See 29 CFR Part 1.8 and 29 CFR Part 7). Requests for review and reconsideration can be submitted via email to dba.reconsideration@dol.gov or by mail to:

Wage and Hour Administrator
U.S. Department of Labor
200 Constitution Avenue, N.W.
Washington, DC 20210

The request should be accompanied by a full statement of the interested party's position and any information (wage payment data, project description, area practice material, etc.) that the requestor considers relevant to the issue.

3) If the decision of the Administrator is not favorable, an interested party may appeal directly to the Administrative Review Board (formerly the Wage Appeals Board). Write to:

Administrative Review Board
U.S. Department of Labor
200 Constitution Avenue, N.W.
Washington, DC 20210.

=====

END OF GENERAL DECISION

..

"General Decision Number: ME20260042 01/02/2026

Superseded General Decision Number: ME20250042

State: Maine

Construction Type: Highway

County: Somerset County in Maine.

HIGHWAY CONSTRUCTION PROJECTS

Modification Number 0 Publication Date 01/02/2026

ENGI0004-022 04/01/2025

	Rates	Fringes
POWER EQUIPMENT OPERATOR: Grader/Blade, Milling Machine.....	\$ 30.17	13.80

SUME2014-037 06/23/2017

	Rates	Fringes
CARPENTER, Includes Form Work....	\$ 18.34	2.84
HIGHWAY/PARKING LOT STRIPING: Laborer.....	\$ 14.80	1.27
IRONWORKER, REINFORCING.....	\$ 16.27	0.00
LABORER: Asphalt, Includes Raker, Shoveler, Spreader and Distributor.....	\$ 15.40	2.69
LABORER: Common or General.....	\$ 14.42	2.68
LABORER: Landscape.....	\$ 18.69	2.70
LABORER: Wheelman.....	\$ 15.64	4.29
OPERATOR: Backhoe/Excavator/Trackhoe.....	\$ 18.80	4.16
OPERATOR: Bobcat/Skid Steer/Skid Loader.....	\$ 21.66	4.91
OPERATOR: Broom/Sweeper.....	\$ 19.09	5.20
OPERATOR: Bulldozer.....	\$ 17.30	3.50
OPERATOR: Loader.....	\$ 18.59	5.53
OPERATOR: Mechanic.....	\$ 22.07	8.73
OPERATOR: Paver (Asphalt, Aggregate, and Concrete).....	\$ 20.92	6.19
OPERATOR: Screed.....	\$ 19.02	4.82
OPERATOR: Roller (Earth).....	\$ 16.43	3.40

OPERATOR: Roller Asphalt.....	\$ 21.56	5.42
TRAFFIC CONTROL: Flagger.....	\$ 9.38	0.00
TRAFFIC CONTROL:		
Laborer-Cones/ Barricades/Barrels - Setter/Mover/Sweeper.....		
	\$ 17.47	4.80
TRUCK DRIVER: Dump Truck.....	\$ 15.07	5.15
TRUCK DRIVER: TackTruck.....	\$ 20.18	7.75

WELDERS - Receive rate prescribed for craft performing operation to which welding is incidental.

=====

Note: Executive Order (EO) 13706, Establishing Paid Sick Leave for Federal Contractors applies to all contracts subject to the Davis-Bacon Act for which the contract is awarded (and any solicitation was issued) on or after January 1, 2017. If this contract is covered by the EO, the contractor must provide employees with 1 hour of paid sick leave for every 30 hours they work, up to 56 hours of paid sick leave each year. Employees must be permitted to use paid sick leave for their own illness, injury or other health-related needs, including preventive care; to assist a family member (or person who is like family to the employee) who is ill, injured, or has other health-related needs, including preventive care; or for reasons resulting from, or to assist a family member (or person who is like family to the employee) who is a victim of, domestic violence, sexual assault, or stalking. Additional information on contractor requirements and worker protections under the EO is available at <https://www.dol.gov/agencies/whd/government-contracts>.

Note: Executive Order 13658 generally applies to contracts subject to the Davis-Bacon Act that were awarded on or between January 1, 2015 and January 29, 2022, and that have not been renewed or extended on or after January 30, 2022. Executive Order 13658 does not apply to contracts subject only to the Davis-Bacon Related Acts regardless of when they were awarded. If a contract is subject to Executive Order 13658, the contractor must pay all covered workers at least \$13.30 per hour (or the applicable wage rate listed on this wage determination, if it is higher) for all hours spent performing on the contract in 2025. The applicable Executive Order minimum wage rate will be adjusted annually. Additional information on contractor requirements and worker protections under Executive Order 13658 is available at www.dol.gov/whd/govcontracts.

Unlisted classifications needed for work not included within the scope of the classifications listed may be added after award only as provided in the labor standards contract clauses (29CFR 5.5 (a) (1) (iii)).

The body of each wage determination lists the classifications and wage rates that have been found to be prevailing for the

type(s) of construction and geographic area covered by the wage determination. The classifications are listed in alphabetical order under rate identifiers indicating whether the particular rate is a union rate (current union negotiated rate), a survey rate, a weighted union average rate, a state adopted rate, or a supplemental classification rate.

Union Rate Identifiers

A four-letter identifier beginning with characters other than "SU", "UAVG", "SA", or "SC" denotes that a union rate was prevailing for that classification in the survey. Example: PLUM0198-005 07/01/2024. PLUM is an identifier of the union whose collectively bargained rate prevailed in the survey for this classification, which in this example would be Plumbers. 0198 indicates the local union number or district council number where applicable, i.e., Plumbers Local 0198. The next number, 005 in the example, is an internal number used in processing the wage determination. The date, 07/01/2024 in the example, is the effective date of the most current negotiated rate.

Union prevailing wage rates are updated to reflect all changes over time that are reported to WHD in the rates in the collective bargaining agreement (CBA) governing the classification.

Union Average Rate Identifiers

The UAVG identifier indicates that no single rate prevailed for those classifications, but that 100% of the data reported for the classifications reflected union rates. EXAMPLE: UAVG-OH-0010 01/01/2024. UAVG indicates that the rate is a weighted union average rate. OH indicates the State of Ohio. The next number, 0010 in the example, is an internal number used in producing the wage determination. The date, 01/01/2024 in the example, indicates the date the wage determination was updated to reflect the most current union average rate.

A UAVG rate will be updated once a year, usually in January, to reflect a weighted average of the current rates in the collective bargaining agreements on which the rate is based.

Survey Rate Identifiers

The "SU" identifier indicates that either a single non-union rate prevailed (as defined in 29 CFR 1.2) for this classification in the survey or that the rate was derived by computing a weighted average rate based on all the rates reported in the survey for that classification. As a weighted average rate includes all rates reported in the survey, it may include both union and non-union rates. Example: SUFL2022-007 6/27/2024. SU indicates the rate is a single non-union prevailing rate or a weighted average of survey data for that classification. FL indicates the State of Florida. 2022 is the year of the survey on which these classifications and rates are based. The next number, 007 in the example, is an internal number used in producing the wage determination. The date, 6/27/2024 in the example, indicates the survey completion date for the classifications and rates under that identifier.

"SU" wage rates typically remain in effect until a new survey is conducted. However, the Wage and Hour Division (WHD) has the discretion to update such rates under 29 CFR 1.6(c)(1).

State Adopted Rate Identifiers

The "SA" identifier indicates that the classifications and prevailing wage rates set by a state (or local) government were adopted under 29 C.F.R 1.3(g)-(h). Example: SAME2023-007 01/03/2024. SA reflects that the rates are state adopted. ME refers to the State of Maine. 2023 is the year during which the state completed the survey on which the listed classifications and rates are based. The next number, 007 in the example, is an internal number used in producing the wage determination. The date, 01/03/2024 in the example, reflects the date on which the classifications and rates under the ?SA? identifier took effect under state law in the state from which the rates were adopted.

WAGE DETERMINATION APPEALS PROCESS

1) Has there been an initial decision in the matter? This can be:

- a) a survey underlying a wage determination
- b) an existing published wage determination
- c) an initial WHD letter setting forth a position on a wage determination matter
- d) an initial conformance (additional classification and rate) determination

On survey related matters, initial contact, including requests for summaries of surveys, should be directed to the WHD Branch of Wage Surveys. Requests can be submitted via email to davisbaconinfo@dol.gov or by mail to:

Branch of Wage Surveys
 Wage and Hour Division
 U.S. Department of Labor
 200 Constitution Avenue, N.W.
 Washington, DC 20210

Regarding any other wage determination matter such as conformance decisions, requests for initial decisions should be directed to the WHD Branch of Construction Wage Determinations. Requests can be submitted via email to BCWD-Office@dol.gov or by mail to:

Branch of Construction Wage Determinations
 Wage and Hour Division
 U.S. Department of Labor
 200 Constitution Avenue, N.W.
 Washington, DC 20210

2) If an initial decision has been issued, then any interested party (those affected by the action) that disagrees with the decision can request review and reconsideration from the Wage and Hour Administrator (See 29 CFR Part 1.8 and 29 CFR Part 7). Requests for review and reconsideration can be submitted via email to dba.reconsideration@dol.gov or by mail to:

Wage and Hour Administrator
 U.S. Department of Labor
 200 Constitution Avenue, N.W.
 Washington, DC 20210

The request should be accompanied by a full statement of the

interested party's position and any information (wage payment data, project description, area practice material, etc.) that the requestor considers relevant to the issue.

3) If the decision of the Administrator is not favorable, an interested party may appeal directly to the Administrative Review Board (formerly the Wage Appeals Board). Write to:

Administrative Review Board
U.S. Department of Labor
200 Constitution Avenue, N.W.
Washington, DC 20210.

=====

END OF GENERAL DECISION

..

"General Decision Number: ME20260043 01/02/2026

Superseded General Decision Number: ME20250043

State: Maine

Construction Type: Highway

County: Waldo County in Maine.

HIGHWAY CONSTRUCTION PROJECTS

Modification Number 0 Publication Date 01/02/2026

ENGI0004-005 04/01/2025

	Rates	Fringes
POWER EQUIPMENT OPERATOR: Grader/Blade, Milling Machine, Paver (Asphalt, Aggregate, and Concrete), Roller Asphalt.....	\$ 30.17	13.80

SUME2014-038 06/23/2017

	Rates	Fringes
CARPENTER, Includes Form Work....	\$ 18.34	2.84
HIGHWAY/PARKING LOT STRIPING: Laborer.....	\$ 14.80	1.27
IRONWORKER, REINFORCING.....	\$ 16.27	0.00
LABORER: Asphalt, Includes Raker, Shoveler, Spreader and Distributor.....	\$ 15.40	2.69
LABORER: Common or General.....	\$ 13.27	1.43
LABORER: Landscape.....	\$ 18.69	2.70
LABORER: Wheelman.....	\$ 15.64	4.29
OPERATOR: Backhoe/Excavator/Trackhoe.....	\$ 18.80	4.16
OPERATOR: Bobcat/Skid Steer/Skid Loader.....	\$ 21.66	4.91
OPERATOR: Broom/Sweeper.....	\$ 19.09	5.20
OPERATOR: Bulldozer.....	\$ 17.30	3.50
OPERATOR: Loader.....	\$ 18.59	5.53
OPERATOR: Mechanic.....	\$ 22.07	8.73
OPERATOR: Screed.....	\$ 19.02	4.82
OPERATOR: Roller (Earth).....	\$ 16.43	3.40

TRAFFIC CONTROL: Flagger.....\$	9.38	0.00
TRAFFIC CONTROL:		
Laborer-Cones/ Barricades/Barrels - Setter/Mover/Sweeper.....\$		
	17.47	4.80
TRUCK DRIVER: Dump Truck.....\$	13.98	7.90
TRUCK DRIVER: TackTruck.....\$	20.18	7.75

WELDERS - Receive rate prescribed for craft performing operation to which welding is incidental.

=====
Note: Executive Order (EO) 13706, Establishing Paid Sick Leave for Federal Contractors applies to all contracts subject to the Davis-Bacon Act for which the contract is awarded (and any solicitation was issued) on or after January 1, 2017. If this contract is covered by the EO, the contractor must provide employees with 1 hour of paid sick leave for every 30 hours they work, up to 56 hours of paid sick leave each year. Employees must be permitted to use paid sick leave for their own illness, injury or other health-related needs, including preventive care; to assist a family member (or person who is like family to the employee) who is ill, injured, or has other health-related needs, including preventive care; or for reasons resulting from, or to assist a family member (or person who is like family to the employee) who is a victim of, domestic violence, sexual assault, or stalking. Additional information on contractor requirements and worker protections under the EO is available at <https://www.dol.gov/agencies/whd/government-contracts>.

Note: Executive Order 13658 generally applies to contracts subject to the Davis-Bacon Act that were awarded on or between January 1, 2015 and January 29, 2022, and that have not been renewed or extended on or after January 30, 2022. Executive Order 13658 does not apply to contracts subject only to the Davis-Bacon Related Acts regardless of when they were awarded. If a contract is subject to Executive Order 13658, the contractor must pay all covered workers at least \$13.30 per hour (or the applicable wage rate listed on this wage determination, if it is higher) for all hours spent performing on the contract in 2025. The applicable Executive Order minimum wage rate will be adjusted annually. Additional information on contractor requirements and worker protections under Executive Order 13658 is available at www.dol.gov/whd/govcontracts.

Unlisted classifications needed for work not included within the scope of the classifications listed may be added after award only as provided in the labor standards contract clauses (29CFR 5.5 (a) (1) (iii)).

The body of each wage determination lists the classifications and wage rates that have been found to be prevailing for the type(s) of construction and geographic area covered by the wage determination. The classifications are listed in alphabetical order under rate identifiers indicating whether the particular

rate is a union rate (current union negotiated rate), a survey rate, a weighted union average rate, a state adopted rate, or a supplemental classification rate.

Union Rate Identifiers

A four-letter identifier beginning with characters other than ""SU"", ""UAVG"", ?SA?, or ?SC? denotes that a union rate was prevailing for that classification in the survey. Example: PLUM0198-005 07/01/2024. PLUM is an identifier of the union whose collectively bargained rate prevailed in the survey for this classification, which in this example would be Plumbers. 0198 indicates the local union number or district council number where applicable, i.e., Plumbers Local 0198. The next number, 005 in the example, is an internal number used in processing the wage determination. The date, 07/01/2024 in the example, is the effective date of the most current negotiated rate.

Union prevailing wage rates are updated to reflect all changes over time that are reported to WHD in the rates in the collective bargaining agreement (CBA) governing the classification.

Union Average Rate Identifiers

The UAVG identifier indicates that no single rate prevailed for those classifications, but that 100% of the data reported for the classifications reflected union rates. EXAMPLE: UAVG-OH-0010 01/01/2024. UAVG indicates that the rate is a weighted union average rate. OH indicates the State of Ohio. The next number, 0010 in the example, is an internal number used in producing the wage determination. The date, 01/01/2024 in the example, indicates the date the wage determination was updated to reflect the most current union average rate.

A UAVG rate will be updated once a year, usually in January, to reflect a weighted average of the current rates in the collective bargaining agreements on which the rate is based.

Survey Rate Identifiers

The ""SU"" identifier indicates that either a single non-union rate prevailed (as defined in 29 CFR 1.2) for this classification in the survey or that the rate was derived by computing a weighted average rate based on all the rates reported in the survey for that classification. As a weighted average rate includes all rates reported in the survey, it may include both union and non-union rates. Example: SUFL2022-007 6/27/2024. SU indicates the rate is a single non-union prevailing rate or a weighted average of survey data for that classification. FL indicates the State of Florida. 2022 is the year of the survey on which these classifications and rates are based. The next number, 007 in the example, is an internal number used in producing the wage determination. The date, 6/27/2024 in the example, indicates the survey completion date for the classifications and rates under that identifier.

?SU? wage rates typically remain in effect until a new survey is conducted. However, the Wage and Hour Division (WHD) has the discretion to update such rates under 29 CFR 1.6(c)(1).

State Adopted Rate Identifiers

The ""SA"" identifier indicates that the classifications and

prevailing wage rates set by a state (or local) government were adopted under 29 C.F.R 1.3(g)-(h). Example: SAME2023-007 01/03/2024. SA reflects that the rates are state adopted. ME refers to the State of Maine. 2023 is the year during which the state completed the survey on which the listed classifications and rates are based. The next number, 007 in the example, is an internal number used in producing the wage determination. The date, 01/03/2024 in the example, reflects the date on which the classifications and rates under the ?SA? identifier took effect under state law in the state from which the rates were adopted.

WAGE DETERMINATION APPEALS PROCESS

1) Has there been an initial decision in the matter? This can be:

- a) a survey underlying a wage determination
- b) an existing published wage determination
- c) an initial WHD letter setting forth a position on a wage determination matter
- d) an initial conformance (additional classification and rate) determination

On survey related matters, initial contact, including requests for summaries of surveys, should be directed to the WHD Branch of Wage Surveys. Requests can be submitted via email to davisbaconinfo@dol.gov or by mail to:

Branch of Wage Surveys
Wage and Hour Division
U.S. Department of Labor
200 Constitution Avenue, N.W.
Washington, DC 20210

Regarding any other wage determination matter such as conformance decisions, requests for initial decisions should be directed to the WHD Branch of Construction Wage Determinations. Requests can be submitted via email to BCWD-Office@dol.gov or by mail to:

Branch of Construction Wage Determinations
Wage and Hour Division
U.S. Department of Labor
200 Constitution Avenue, N.W.
Washington, DC 20210

2) If an initial decision has been issued, then any interested party (those affected by the action) that disagrees with the decision can request review and reconsideration from the Wage and Hour Administrator (See 29 CFR Part 1.8 and 29 CFR Part 7). Requests for review and reconsideration can be submitted via email to dba.reconsideration@dol.gov or by mail to:

Wage and Hour Administrator
U.S. Department of Labor
200 Constitution Avenue, N.W.
Washington, DC 20210

The request should be accompanied by a full statement of the interested party's position and any information (wage payment data, project description, area practice material, etc.) that the requestor considers relevant to the issue.

3) If the decision of the Administrator is not favorable, an interested party may appeal directly to the Administrative Review Board (formerly the Wage Appeals Board). Write to:

Administrative Review Board
U.S. Department of Labor
200 Constitution Avenue, N.W.
Washington, DC 20210.

=====

END OF GENERAL DECISION

..

"General Decision Number: ME20260049 01/02/2026

Superseded General Decision Number: ME20250049

State: Maine

Construction Type: Highway

County: York County in Maine.

HIGHWAY CONSTRUCTION PROJECTS

Modification Number 0 Publication Date 01/02/2026

SUME2014-044 06/23/2017

	Rates	Fringes
CARPENTER, Includes Form Work....	\$ 18.66	3.46
CEMENT MASON/CONCRETE FINISHER...	\$ 19.83	1.16
ELECTRICIAN.....	\$ 25.21	5.63
HIGHWAY/PARKING LOT STRIPING: Laborer.....	\$ 16.27	2.19
INSTALLER - GUARDRAIL.....	\$ 19.98	2.55
IRONWORKER, REINFORCING.....	\$ 21.85	0.00
IRONWORKER, STRUCTURAL.....	\$ 22.78	4.40
LABORER: Asphalt, Includes Raker, Shoveler, Spreader and Distributor.....	\$ 17.53	2.13
LABORER: Common or General.....	\$ 15.11	2.46
LABORER: Epoxy Injector (Concrete).....	\$ 13.43	1.15
LABORER: Wheelman.....	\$ 20.97	5.13
OPERATOR: Backhoe/Excavator/Trackhoe.....	\$ 20.58	3.81
OPERATOR: Bobcat/Skid Steer/Skid Loader.....	\$ 23.66	0.97
OPERATOR: Broom/Sweeper.....	\$ 19.49	0.00
OPERATOR: Bulldozer.....	\$ 21.71	5.67
OPERATOR: Grader/Blade.....	\$ 27.40	8.13
OPERATOR: Loader.....	\$ 18.91	3.27
OPERATOR: Mechanic.....	\$ 24.71	7.83
OPERATOR: Milling Machine.....	\$ 27.44	6.37
OPERATOR: Paver (Asphalt,		

Aggregate, and Concrete).....\$ 20.17	4.83
OPERATOR: Roller (Earth).....\$ 16.52	1.66
OPERATOR: Roller Asphalt.....\$ 19.64	6.09
TRAFFIC CONTROL: Flagger.....\$ 10.33	0.00
TRAFFIC CONTROL: Laborer-Cones/ Barricades/Barrels - Setter/Mover/Sweeper.....\$ 17.84	
TRUCK DRIVER: Dump Truck.....\$ 19.99	4.00

WELDERS - Receive rate prescribed for craft performing operation to which welding is incidental.

=====

Note: Executive Order (EO) 13706, Establishing Paid Sick Leave for Federal Contractors applies to all contracts subject to the Davis-Bacon Act for which the contract is awarded (and any solicitation was issued) on or after January 1, 2017. If this contract is covered by the EO, the contractor must provide employees with 1 hour of paid sick leave for every 30 hours they work, up to 56 hours of paid sick leave each year. Employees must be permitted to use paid sick leave for their own illness, injury or other health-related needs, including preventive care; to assist a family member (or person who is like family to the employee) who is ill, injured, or has other health-related needs, including preventive care; or for reasons resulting from, or to assist a family member (or person who is like family to the employee) who is a victim of, domestic violence, sexual assault, or stalking. Additional information on contractor requirements and worker protections under the EO is available at <https://www.dol.gov/agencies/whd/government-contracts>.

Note: Executive Order 13658 generally applies to contracts subject to the Davis-Bacon Act that were awarded on or between January 1, 2015 and January 29, 2022, and that have not been renewed or extended on or after January 30, 2022. Executive Order 13658 does not apply to contracts subject only to the Davis-Bacon Related Acts regardless of when they were awarded. If a contract is subject to Executive Order 13658, the contractor must pay all covered workers at least \$13.30 per hour (or the applicable wage rate listed on this wage determination, if it is higher) for all hours spent performing on the contract in 2025. The applicable Executive Order minimum wage rate will be adjusted annually. Additional information on contractor requirements and worker protections under Executive Order 13658 is available at www.dol.gov/whd/govcontracts.

Unlisted classifications needed for work not included within the scope of the classifications listed may be added after award only as provided in the labor standards contract clauses (29CFR 5.5 (a) (1) (iii)).

The body of each wage determination lists the classifications

and wage rates that have been found to be prevailing for the type(s) of construction and geographic area covered by the wage determination. The classifications are listed in alphabetical order under rate identifiers indicating whether the particular rate is a union rate (current union negotiated rate), a survey rate, a weighted union average rate, a state adopted rate, or a supplemental classification rate.

Union Rate Identifiers

A four-letter identifier beginning with characters other than "SU", "UAVG", "SA", or "SC" denotes that a union rate was prevailing for that classification in the survey. Example: PLUM0198-005 07/01/2024. PLUM is an identifier of the union whose collectively bargained rate prevailed in the survey for this classification, which in this example would be Plumbers. 0198 indicates the local union number or district council number where applicable, i.e., Plumbers Local 0198. The next number, 005 in the example, is an internal number used in processing the wage determination. The date, 07/01/2024 in the example, is the effective date of the most current negotiated rate.

Union prevailing wage rates are updated to reflect all changes over time that are reported to WHD in the rates in the collective bargaining agreement (CBA) governing the classification.

Union Average Rate Identifiers

The UAVG identifier indicates that no single rate prevailed for those classifications, but that 100% of the data reported for the classifications reflected union rates. EXAMPLE: UAVG-OH-0010 01/01/2024. UAVG indicates that the rate is a weighted union average rate. OH indicates the State of Ohio. The next number, 0010 in the example, is an internal number used in producing the wage determination. The date, 01/01/2024 in the example, indicates the date the wage determination was updated to reflect the most current union average rate.

A UAVG rate will be updated once a year, usually in January, to reflect a weighted average of the current rates in the collective bargaining agreements on which the rate is based.

Survey Rate Identifiers

The "SU" identifier indicates that either a single non-union rate prevailed (as defined in 29 CFR 1.2) for this classification in the survey or that the rate was derived by computing a weighted average rate based on all the rates reported in the survey for that classification. As a weighted average rate includes all rates reported in the survey, it may include both union and non-union rates. Example: SUFL2022-007 6/27/2024. SU indicates the rate is a single non-union prevailing rate or a weighted average of survey data for that classification. FL indicates the State of Florida. 2022 is the year of the survey on which these classifications and rates are based. The next number, 007 in the example, is an internal number used in producing the wage determination. The date, 6/27/2024 in the example, indicates the survey completion date for the classifications and rates under that identifier.

"SU" wage rates typically remain in effect until a new survey is conducted. However, the Wage and Hour Division (WHD) has the discretion to update such rates under 29 CFR 1.6(c)(1).

State Adopted Rate Identifiers

The ""SA"" identifier indicates that the classifications and prevailing wage rates set by a state (or local) government were adopted under 29 C.F.R 1.3(g)-(h). Example: SAME2023-007 01/03/2024. SA reflects that the rates are state adopted. ME refers to the State of Maine. 2023 is the year during which the state completed the survey on which the listed classifications and rates are based. The next number, 007 in the example, is an internal number used in producing the wage determination. The date, 01/03/2024 in the example, reflects the date on which the classifications and rates under the ?SA? identifier took effect under state law in the state from which the rates were adopted.

WAGE DETERMINATION APPEALS PROCESS

1) Has there been an initial decision in the matter? This can be:

- a) a survey underlying a wage determination
- b) an existing published wage determination
- c) an initial WHD letter setting forth a position on a wage determination matter
- d) an initial conformance (additional classification and rate) determination

On survey related matters, initial contact, including requests for summaries of surveys, should be directed to the WHD Branch of Wage Surveys. Requests can be submitted via email to davisbaconinfo@dol.gov or by mail to:

Branch of Wage Surveys
Wage and Hour Division
U.S. Department of Labor
200 Constitution Avenue, N.W.
Washington, DC 20210

Regarding any other wage determination matter such as conformance decisions, requests for initial decisions should be directed to the WHD Branch of Construction Wage Determinations. Requests can be submitted via email to BCWD-Office@dol.gov or by mail to:

Branch of Construction Wage Determinations
Wage and Hour Division
U.S. Department of Labor
200 Constitution Avenue, N.W.
Washington, DC 20210

2) If an initial decision has been issued, then any interested party (those affected by the action) that disagrees with the decision can request review and reconsideration from the Wage and Hour Administrator (See 29 CFR Part 1.8 and 29 CFR Part 7). Requests for review and reconsideration can be submitted via email to dba.reconsideration@dol.gov or by mail to:

Wage and Hour Administrator
U.S. Department of Labor
200 Constitution Avenue, N.W.
Washington, DC 20210

The request should be accompanied by a full statement of the interested party's position and any information (wage payment data, project description, area practice material, etc.) that the requestor considers relevant to the issue.

3) If the decision of the Administrator is not favorable, an interested party may appeal directly to the Administrative Review Board (formerly the Wage Appeals Board). Write to:

Administrative Review Board
U.S. Department of Labor
200 Constitution Avenue, N.W.
Washington, DC 20210.

=====

END OF GENERAL DECISION

..

MaineDOT Regions

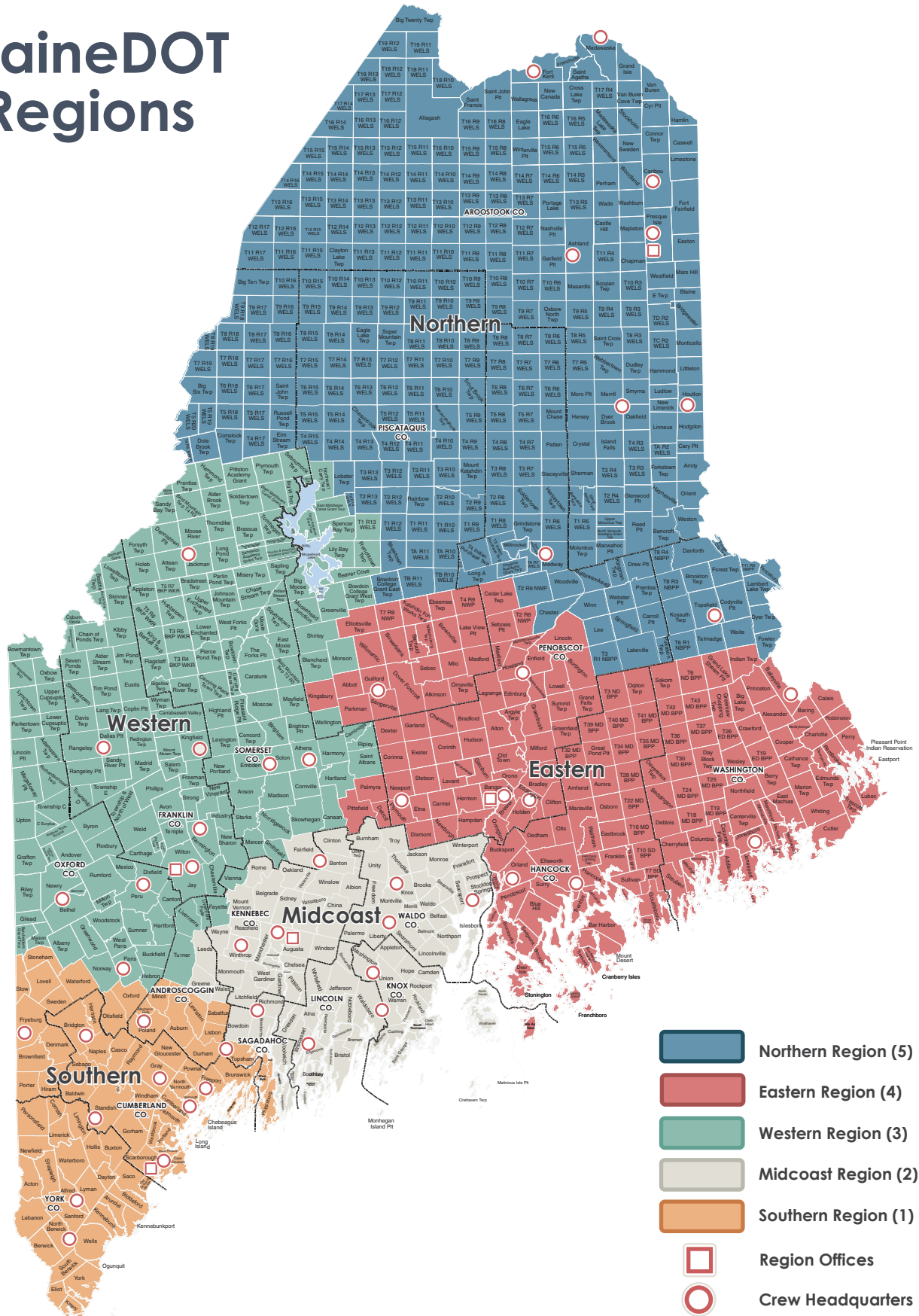

- Northern Region (5)
- Eastern Region (4)
- Western Region (3)
- Midcoast Region (2)
- Southern Region (1)
- Region Offices
- Crew Headquarters



Revised Sept. 2020

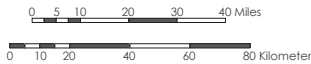

Region 1 - Southern

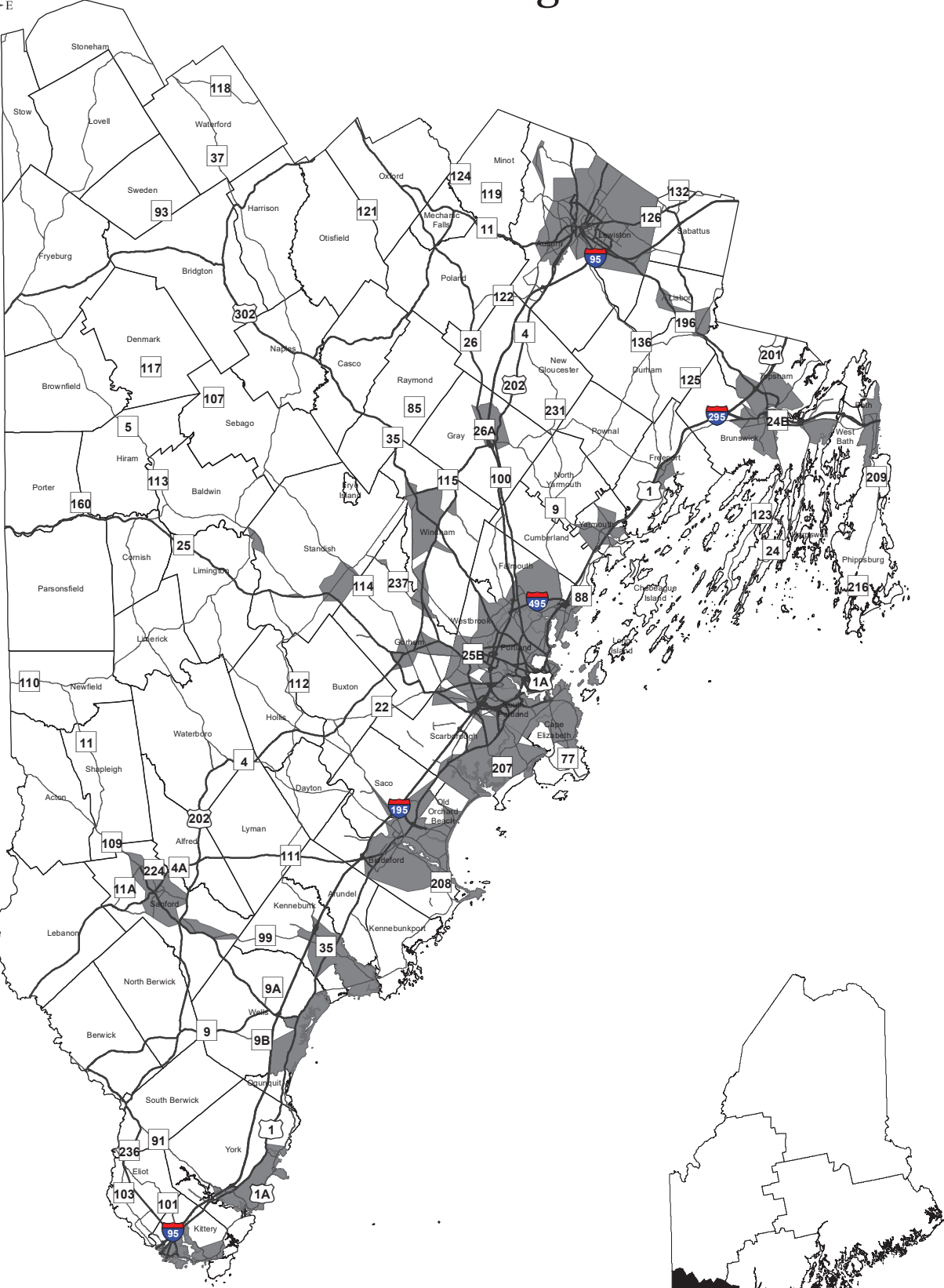

- Arterials
- Major Collectors
- State Urban Areas

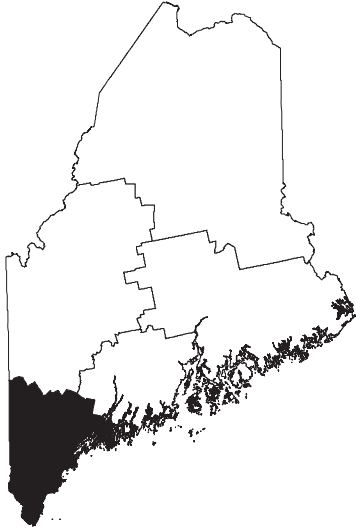



Region 2 - Midcoast

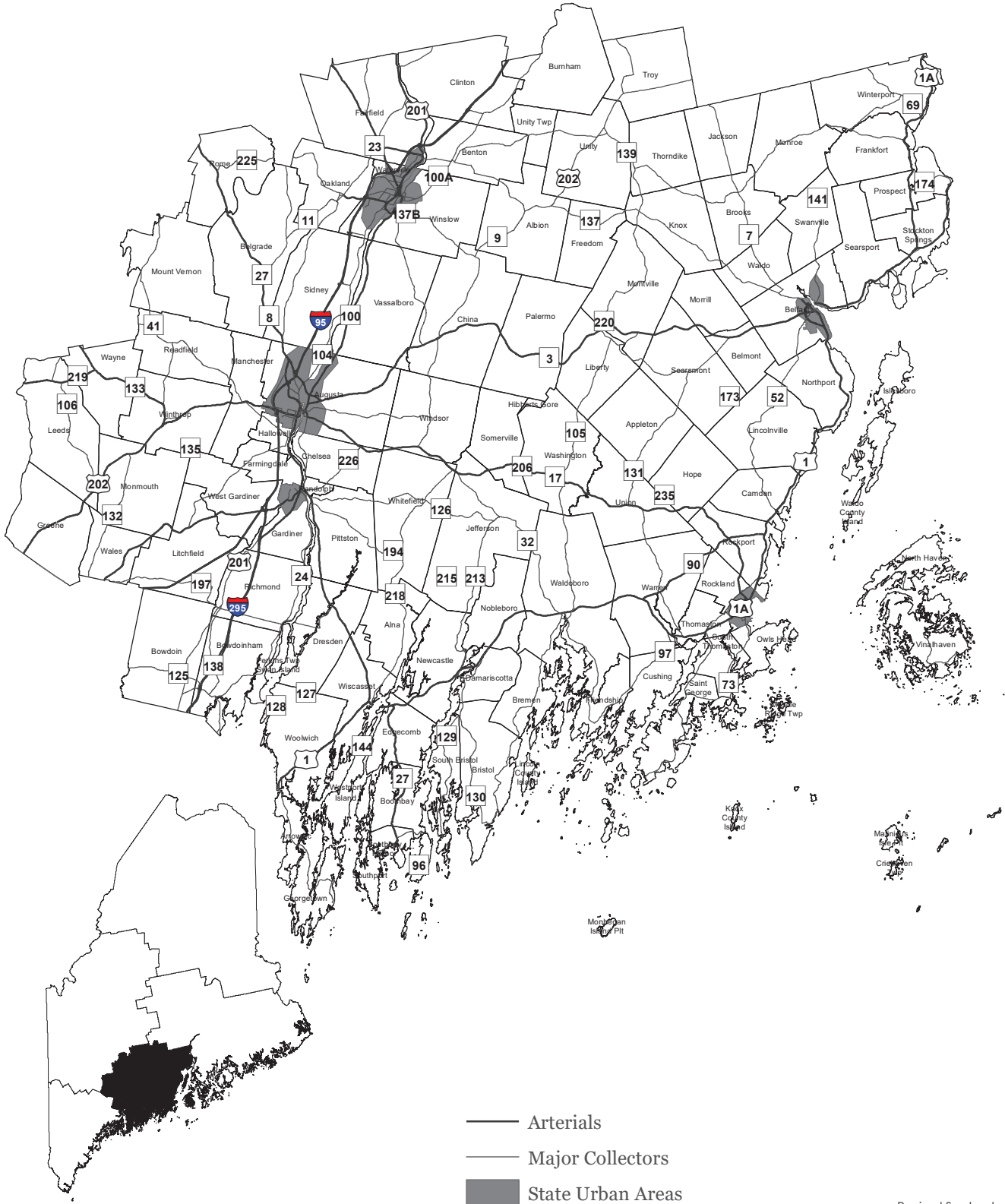

- Arterials
- Major Collectors
- State Urban Areas



Region 3 - Western

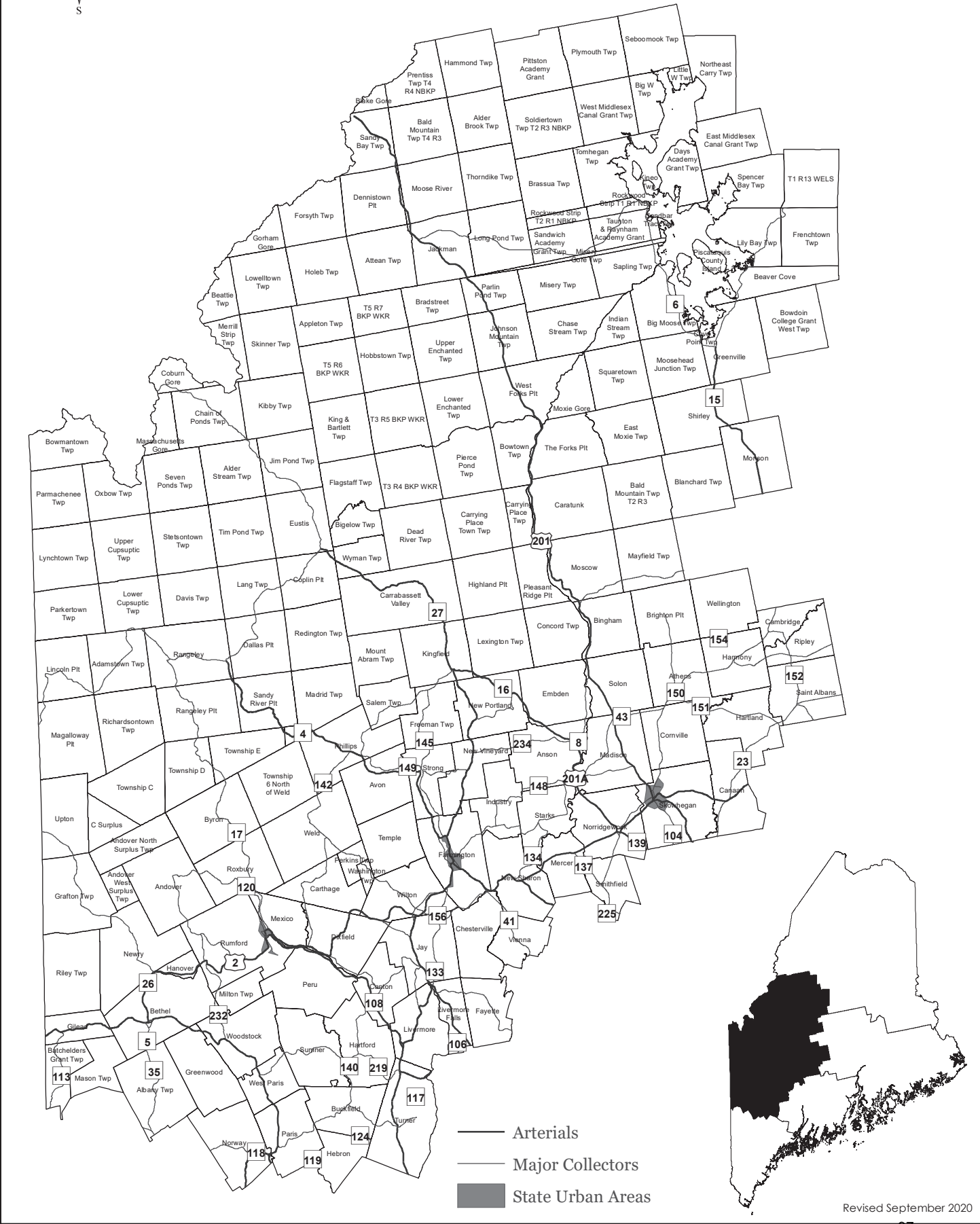

SPECIAL PROVISION
SECTIONS 102 BIDDING
& 103 AWARD & CONTRACTING
(Basis of Award)

Withdrawal of Bids in Multiple Bid Context

Bids may not be withdrawn after the time of Bid Opening, except under the limited circumstance set forth in this Section.

If a Bidder has submitted Bids for multiple Projects that have the same Bid Opening time, and if after the reading of Bids, the Bidder has submitted the apparent low Bid on more than one Project, then the Bidder may withdraw any Bids on one or more Projects if they do not have sufficient personnel and equipment available to deliver the Work according to the contract schedule in all Areas for which they have submitted the apparent low Bid. Such a request for withdrawal must be made in writing. Bids withdrawn will not be considered.

SPECIAL PROVISION
SECTION 103
AWARD AND CONTRACTING
(Post-Bid, Pre-Award Qualifications)

Standard Specification Section 103.3 Post-Bid Qualification Delete the entire section and replace with the following:

After Bid Opening and as a condition for Award of the Contract, the Department may require an Apparent Successful Bidder to demonstrate to the Department's satisfaction that the bidder is responsible, meets the Contractor Requirements set forth in this contract, and is qualified to perform the Work.

If such qualification is required, the Department will provide the Bidder with a written Notice of Post-Bid Qualifications requiring the Bidder to provide written documentation presenting evidence of qualifications.

Contractor Requirements

In order to be awarded a contract, the Contractor shall be able to provide all superintendents, forepersons, laborers, Subcontractors, Equipment, Materials, and Incidentals needed to perform the Work in Conformance within the Contract Time. All equipment is subject to the Department's approval, prior to award.

In order to be considered for the award of this contract, the Bidder or key employees that will be assigned to the Work in this Contract shall have successfully completed projects of similar size and scope and have sufficient experience. Said experience shall include, at a minimum, at least three (3) projects of equal or greater complexity than the work required by this Contract completed by the Bidder in the last five (5) years.

Areas of experience shall include, but are not limited to:

- Painted Pavement Markings and Stenciling
- Work performed in live traffic in accordance with the Manual on Uniform Traffic Control Devices (MUTCD)

The Contractor shall maintain current licenses, authorizations, ratings and registrations for the duration of the contract.

The Bidder shall be able to comply with the Contract requirements, be able to deliver according to the contract schedule, and have a history of satisfactory performance.

The Bidder must have a current, applicable Safety Plan on file with the Department or must submit, prior to Contract award, an acceptable, current Safety Plan or Project and Site Specific Safety Plan to the Department which identifies and addresses job hazards of the

expected contract work and complies with all applicable federal, State, and local laws governing safety including all applicable laws and regulations of Occupational Safety and Health Administration (OSHA).

The Bidder may be required to provide any information requested in the “Contractor’s Prequalification Application” form adopted by the Department.

Post-bid Qualification Submittals

The Department will notify the Apparent Successful Bidder of the requirements for post-bid, pre-award qualifications and the Bidder shall provide all of the items within seven (7) days of the notice. The Contractor shall submit two copies or an electronic copy of all required submittals to the Department.

The Bidder may be required to submit evidence of compliance with all Contractor Requirements set forth in this Contract.

If the Bidder does not have a history of satisfactory performance performing similar Work under contracts with the Department that meets the Contractor Requirements regarding experience, the Bidder may be required to submit written documentation setting forth the experience of the Bidder or key employees, or subcontractor(s) who will be performing the Work specified in the contract documents, including a description of similar construction projects completed in the last five (5) years that highlight the Bidder’s and subcontractors’ related experience. Such information shall include:

1. the Company’s history and experience of work related specifically to the Scope of Work in this contract;
2. the name of the owner for whom the work was performed;
3. the name and telephone number of a contact person;
4. a description of the work performed by the Bidder or their subcontractor; and
5. the total construction cost of each project, and the value of work performed by the Bidder or their subcontractor.

The Bidder may be required to submit the relevant experience of the key personnel and supervisors who will be performing Work under this contract, their experience and number of years performing work related specifically to the Scope of Work in this contract.

The Bidder’s submittal may be required to include a statement describing the personnel and equipment available for the Work and demonstrating that the Bidder is able to deliver according to the contract schedule. The Department reserves the right, prior to initial use, to inspect the equipment and reject due to lack of conformance with specifications or condition deficiencies. Condition deficiencies may include, but are not limited to, equipment with excessive wear, broken parts, low hydraulic pressure, below standard operation, equipment that is not OSHA compliant or equipment with leaks that can get to the pavement, ground or into water bodies.

If a Bidder has not previously submitted Traffic Control Plans (TCP) for other Department projects, the Contractor must submit, prior to Contract award, a substantially complete, acceptable, project specific Traffic Control Plan.

If the Bidder is to provide any information requested in the “Contractor’s Prequalification Application” form adopted by the Department, the Notice of Post-Bid Qualifications shall so state.

If a current, applicable copy of the Contractor’s Safety Plan is not on file with the Department, the Contractor must submit, an acceptable, current Contractor’s Safety Plan or Project and Site Specific Safety Plan to the Department in accordance with Special Provision Section 105 Safety Plan. The plan shall identify and addresses job hazards of the expected contract work and comply with all applicable federal, State, and local laws governing safety including all applicable laws and regulations of Occupational Safety and Health Administration (OSHA).

The Bidder may be required to provide its OSHA 300 Log and its Experience Modification Rate provided by applicable insurance.

Upon receipt of the pre-award submittals, the Department will review the submissions and determine if the submitted evidence or information satisfies the Department requirement that the bidder is qualified to properly carry out the terms of the Contract.

The qualifications submitted will be checked for general conformance with the concept of the project and compliance with the requirements set out in the Contract Documents. This review does not modify the Contractor’s duty to comply with the Contract documents.

Bidders shall ensure that all information required herein is submitted. Provision of inaccurate information or failure to provide all completed and required information may result in the Bidder being determined to be “Not Qualified” or disqualified as non-responsive. Within 14 days, the Department will review the required submittals for completeness, conformity with Federal and State requirements, Contract provisions, applicable laws and regulations of Occupational Safety and Health Administration (OSHA), the current edition of the MUTCD, and Department policy and procedures. The Department reserves the right to communicate in writing with Bidders, if needed, to obtain additions to and/or clarification of information contained in the submittals received. Review by the Department, comments by the Department, or any failure to review or comment, shall not absolve the Contractor of its responsibility to develop and implement the Contractor’s Safety Plan or the Project and Site Specific Safety Plan, or the TCP in accordance with the Contract, or to shift any responsibility to the Department. The Bidder shall have 3 days to submit additions and clarifications. The Bidder will have no additional opportunity to submit or clarify information. The Department will not provide an opportunity for the Bidder to meet to present evidence.

A Bidder may be determined to be Qualified in accordance with this Special Provision, and still may need to make minor adjustments to one or more of the plans submitted in order to meet specifications and/or address Department comments. The determination of qualified does absolve the Contractor of the responsibility to submit plans which comply with applicable specifications.

Based on these submissions, the Department will make one of the following determinations:

1. Qualified - The Contractor has satisfied the post-bid, pre-award qualification requirements and demonstrated to the Department's satisfaction that it is responsible, can meet the Contractor Requirements set forth in this contract, and is qualified to perform this type of work. The Contractor may still be required to make minor revisions to one or more of the plans submitted prior to starting on site work.
2. Not Qualified - Bidder is not qualified to properly carry out the terms of the Contract and/or the submission does not meet specifications and accepted standards and is not acceptable, as determined by the Department.

There is no Appeal process and the determination of "Not Qualified" is final. The Department will reject the bid as non-responsive, and the Award process will proceed without the unqualified Bidder.

The Department will notify the Bidder of its determination in writing. If a determination of "Not Qualified" is rendered, the notice will set forth reasons to the extent practical. Such reasons may include the following:

- A. Not meeting contract Contractor Requirements
- B. Unsatisfactory and/or insufficient Contractor and/or key employee experience
- C. Failure to demonstrate ability to do work to the satisfaction and at the sole discretion of the Department
- D. No Safety Plan nor Project and Site Specific Safety Plan, or an unacceptable Safety Plan or Project and Site Specific Safety Plan
- E. Default(s) or termination(s) on past or current Contracts.
- F. Failure to pay or settle all bills for labor, Materials or services on past or current Contracts.
- G. Failure to provide Closeout Documentation on past or current Contracts.
- H. Failure to fulfill warranty obligations on past or current Contracts.

- I. Failure to comply with directives of the Department on past or current Contracts.
- J. "Below Standard" performance as determined from the Department's Contractor's Performance Rating process.
- K. Inability of the Contractor to obtain or retain Performance or Payment Bonds meeting MDOT requirements.
- L. Failure to accept an Award of a Contract made by the Department to the Contractor.
- M. Making materially false, deceptive, or misleading Statements or omissions, whether or not under oath, regarding a claim on prior Contracts or on the Contractor's Prequalification Application or the Post-Bid Qualifications submittals.
- N. Failure to provide information requested by the Department pursuant to this Special Provision.
- O. Any of the reasons contained in Section 102.02 of the "Rules Regarding Debarment of Contractors", Maine Department of Transportation Register 17-229, Chapter 102 (October 2, 1985).
- P. Debarment or suspension by any federal, State, or local governmental procurement agency or the Contractor's Agreement to refrain from Bidding as part of the settlement with any such agencies.
- Q. Other serious misconduct that the Department reasonably determines will substantially and adversely affect the cost, quality or timeliness of Work, or the safety of Workers or the public.

SPECIAL PROVISION
SECTION 104
GENERAL RIGHTS AND RESPONSIBILITIES
(Electronic Payroll Submission)
(Payment Tracking)

104.3.8.1 Electronic Payroll Submission The prime contractor and all subcontractors and lower-tier subcontractors will submit their certified payrolls electronically on this contract utilizing the Elation System web based reporting. There is no charge to the contracting community for the use of this service. The submission of paper payrolls will not be allowed or accepted. Additional information can be found at <http://www.maine.gov/mdot/contractors/> under the first “Notice”.

104.3.8.2 Payment Tracking The prime contractor and all subcontractors and lower-tier subcontractors will track and confirm the delivery and receipt of all payments through the Elation System

SPECIAL PROVISION
SECTION 105
GENERAL SCOPE OF WORK
(Safety Plan)

In order to be awarded a construction contract, the Bidder must have a current, applicable Safety Plan on file with the Department or must submit to the Department's Bureau of Maintenance & Operations, an acceptable, current Contractor's Safety Plan or Project and Site Specific Safety Plan to the Department which identifies and addresses job hazards of the expected contract work and complies with all applicable federal, State, and local laws governing safety including all applicable laws and regulations of Occupational Safety and Health Administration (OSHA).

The Bidder's Project and Site Specific Safety Plan shall address the specific activities or tasks that require protection and establish the procedures that are to be followed to minimize the hazard. Specific statements which describe both what actions is to be taken and how it is to be performed are preferable. The plan shall address the following items which include, but are not limited to:

1. Personal Protective Equipment
2. Materials Handling
3. Vehicular Access to the Work Zone
4. Work Zone Safety and Traffic Control
5. Night Work

If a submittal is required, the Department will notify the Apparent Successful Bidder of the required submittal of the Contractor's Safety Plan or the Project and Site Specific Safety Plan and the Bidder shall submit two copies or an electronic copy to the Department within seven (7) days of the notice or the Department will reject the bid as non-responsive.

Within 14 days, the Department will review the Apparent Low Bidder's Safety Plan. The Department will review a Project and Site Specific Safety Plan to evaluate if the Bidder has a reasonable understanding of job hazards of the expected contract work, has determined preventive measures to overcome these hazards and understands that the work is to be conducted in compliance with this special provision, Contract requirements and all applicable Federal, State, and local laws governing safety including all applicable laws and regulations of OSHA. The Department reserves the right to communicate in writing with Bidders, if needed, to obtain additions to and/or clarification of information contained in the submittals received. Review by the Department, comments by the Department, or any failure to review or comment, shall not absolve the Contractor of its responsibility to develop and implement a Safety Plan in accordance with the Contract, or to shift any responsibility to the Department. The Bidder shall have 3 days to submit additions, changes and clarifications. Following this 3 (three) day period, the Bidder will have no additional opportunity to submit, modify or clarify information. The Department will not provide an opportunity for the

Bidder to meet. If the Department and the Apparent Successful Bidder agree, an extension beyond the 3 days may occur and in such case, there shall also be an equivalent or greater extension beyond the 30 days of the Bid and Bid Prices specified in Standard Specification Section 103.4 Notice of Intent to Award and the Bid remains viable. In no case shall these extensions change the specified Contract Completion Date.

Based on these submissions, the Department will make one of the following determinations:

1. Qualified - The Contractor has satisfied the post-bid, pre-award Safety Plan requirements, however, the Contractor may still be required to make minor revisions to the Safety Plan or Project and Site Specific Safety Plan prior to starting on site work.
2. Not Qualified - Bidder is not qualified to properly carry out the terms of the Contract and/or the submission does not meet specifications and accepted standards and is not acceptable, as determined by the Department.

There is no Appeal process and the determination of "Not Qualified" is final. The Department will reject the bid as non-responsive, and the Award process will proceed without the unqualified Bidder.

Failure by the Contractor to perform the Work in compliance with their submitted Safety Plan, Federal and State requirements, Contract provisions, applicable laws and regulations of OSHA when required or to substantially meet other contractual requirements will be considered a violation and may result in the following actions:

All Incidents: The Contractor will immediately eliminate all unsafe conditions brought to the Contractor's attention by the Department or any other representative of the Department. The Department reserves the right to suspend the work at any time and request a meeting to discuss violations and remedies. The Department shall not be held responsible for any delay in the work due to any suspension under this item.

1st Incident: If the Contractor has previously received a verbal warning for the same or similar unsafe conditions or does not take corrective action immediately upon receipt of verbal warning, the Department will issue a written warning.

2nd Incident: The Department may (A) give written Notice of Default to the Contractor and immediately terminate the Contract by written Notice of Termination, or (B) take prosecution of the Work away from the Contractor without violating the Contract. Such Contractor will be prohibited from submitting a Bid for the Work in the event that the Work is re-advertised. Further, the Department may refuse to accept any Bid from the Contractor on any Project for a period of two years from the date of such refusal. The Department may then take any action that the Department determines is in the best interest of the Department including re-advertising the Work.

SPECIAL PROVISION
SECTION 105
GENERAL SCOPE OF WORK
(Build America, Buy America)

105.11 Other Federal Requirements this section is replaced with the following:

105.11 Build America, Buy America Requirements

Unless expressly otherwise provided in the Bid Documents, the following provisions are hereby incorporated into the Contract.

This project is subject to the Buy America (23 CFR 635.410) and Build America, Buy America Act (BABA) included in the Infrastructure Investment and Jobs Act (IIJA), Public Law No. 117-58. Further guidance can be found at the FHWA Buy America Construction Program Guide linked here:

<https://www.fhwa.dot.gov/construction/cqit/buyam.cfm>

The Contractor shall certify compliance with Buy America and BABA in the following categories. An article, material or supply should only be classified into one of the following categories and is classified based on its state when it arrives at the project site.

1. **Iron and Steel:** All iron and steel permanently incorporated into the project must be produced in the United States. The only exception to this requirement is the production of pig iron and the processing, pelletizing, and reduction of iron ore, which may occur in another country. This means all manufacturing processes, from the initial melting stage through the application of coatings, must occur in the United States. Any process that modifies the chemical content, the physical size and shape, or the final finish is considered a manufacturing process, including rolling, extruding, machining, bending, grinding, drilling, and coating. “Coating” includes epoxy coating, galvanizing, painting, or any other coating that protects or enhances the value of the material.

Existing De Minimis Use Exemption for Iron and Steel: The requirements of the law and regulations do not prevent a minimal use of foreign steel and iron materials if the total cost of such materials used does not exceed one-tenth of one percent (0.1%) of the total construction contract price or \$2,500.00, whichever is greater.

2. **Manufactured Products:** Articles, materials, or supplies that have been processed into a specific form and shape, or combined with other articles, materials, or supplies to create a product with different properties than the individual articles, materials, or supplies. If a domestic product is taken out of the United States for any process, it becomes a foreign source material.

All Manufactured Products used in the project must be manufactured in the United States (“final assembly requirement”). “Component” means an article, material, or supply, whether manufactured or unmanufactured, incorporated directly into a manufactured product or, where applicable, an iron or steel product. If a manufactured product is

predominantly iron, steel, or a combination of both it must meet the above requirements for iron and steel products. Predominantly iron or steel or a combination of both means the total cost of the iron and steel content exceeds 50 percent of the total cost of all its components.

Precast concrete products classified as Manufactured Products must additionally have predominantly iron or steel components meet the above requirements for iron and steel. Cabinets or other enclosures of intelligent transportation systems (ITS) and other electronic hardware systems classified as Manufactured Products must also comply with the above requirements for iron and steel if the cabinet or enclosure is predominantly iron or steel.

3. **Construction Materials:** Items, articles, materials, or supplies that consist of only one of the items listed below:
 - i. Non-ferrous metals.
 - ii. Plastic and polymer-based products (including polyvinylchloride, composite building materials, and polymers used in fiber optic cables).
 - iii. Glass (including optic glass);
 - iv. Fiber optic cable.
 - v. Optical fiber.
 - vi. Lumber.
 - vii. Engineered wood; and
 - viii. Drywall.

Minor additions of articles, materials, supplies, or binding agents to a Construction Material do not change the categorization of the Construction Material.

All Construction Materials permanently incorporated into the project must be produced in the United States. For the Construction Material to be considered “produced in the United States,” it must meet the following standards:

- i. Non-ferrous metals. All manufacturing processes, from initial smelting or melting through final shaping, coating, and assembly, occurred in the United States.
- ii. Plastic and polymer-based products. All manufacturing processes, from initial combination of constituent plastic or polymer-based inputs, or where applicable, constituent composite materials, until the item is in its final form, occurred in the United States.
- iii. Glass. All manufacturing processes, from initial batching and melting of raw materials through annealing, cooling, and cutting, occurred in the United States.
- iv. Fiber optic cable (including drop cable). All manufacturing processes, from the initial ribboning (if applicable), through buffering, fiber stranding, and jacketing, occurred in the United

States. All manufacturing processes also include the standards for glass and optical fiber, but not for non-ferrous metals, plastic, and polymer-based products, or any others.

- v. Optical fiber. All manufacturing processes, from the initial preform fabrication stage through the completion of the draw, occurred in the United States.
- vi. Lumber. All manufacturing processes, from the initial debarking through treatment and planning, occurred in the United States.
- vii. Drywall. All manufacturing processes, from initial blending of mined or synthetic gypsum plaster and additives through cutting and drying of sandwiched panels, occurred in the United States.
- viii. Engineered wood. All manufacturing processes, from the initial combination of constituent materials until the wood product is in its final form, occurred in the United States.

Construction Materials brought on site and combined with other materials are not considered Manufactured Products. Items that consist of two or more of the listed Construction Materials that have been combined off-site through a manufacturing process, and items that include at least one of the listed materials combined with a material that is not listed through a manufacturing process should be treated as Manufactured Products rather than as Construction Materials.

Specifically Excluded Materials

Section 70917(c) of the Build America Buy America Act specifically excludes certain materials from being classified as either construction materials or manufactured products. These exclusions include cement and cementitious materials, aggregates (such as stone, sand, or gravel), and aggregate binding agents or additives.

Additionally, when these materials are combined as an unsettled mixture without a final form upon arriving at the work site, such as wet concrete or hot mix asphalt, the mixture is not considered a manufactured product. However, if these same materials are combined off-site to create a finished product, such as precast concrete, that finished product is considered a manufactured product.

Public Interest Waiver of BABA Requirements for De Minimis Costs

The US Department of Transportation issued a public interest Waiver of Buy America Requirements for De Minimis Costs. The Waiver for De Minimis Costs exempts Manufactured Products and Construction Materials produced outside the United States for which the total value of the non-compliant products is no more than the lesser of \$1,000,000 or 5% of total applicable costs for the project.

The obligation to track costs throughout the life of the contract is the Contractor's responsibility. The term "total applicable costs" is defined as the total actual final material cost of the compliant and non-compliant iron and steel, Manufactured Products, and Construction Materials.

Certification

For iron and steel materials and for Manufactured Products produced predominantly of iron or steel or a combination of both*, the Contractor shall submit a certification from the producer of steel or iron, or any product containing steel or iron as a component, stating that all steel or iron furnished or incorporated into the furnished product was manufactured in the United States in accordance with the requirements of the Buy America provisions of 23 CFR § 635.410, as amended. Such certification shall also include (1) a statement that the iron or steel product or component was produced entirely within the United States, or (2) a statement that the iron or steel product or component was produced within the United States, except for minimal quantities of foreign steel and iron valued at \$ (actual value). A “Buy America” Certification is required from each manufacturer, fabricator, supplier, subcontractor that engages in “manufacturing” as defined above.

**Predominantly of iron or steel or a combination of both means that the cost of the iron and steel content exceeds 50% of the total cost of all its components. The cost of iron and steel is the cost of the iron or steel mill products, castings, or forgings utilized in the manufacture of the product and a good faith estimate of the cost of the iron or steel components.*

In addition, upon completion of the project, the Contractor shall certify in writing as to the overall compliance with BABA and provide the total project delivered cost of all foreign Manufactured Products and Construction Materials. The Contractor shall also submit individual certifications from all subcontractors and suppliers that furnish applicable Construction Materials and Manufactured Products valued at \$10,000 or more. Such individual certifications shall be submitted upon delivery of the Construction Material or Manufactured Products to the site.

Example Certification:

I hereby certify that this project is in compliance with the Build America, Buy America Act (Public Law 117- 58) requirements for this project. All Iron and Steel, Manufactured Products produced predominantly of steel or iron, Manufactured Products and Construction Materials that are permanently incorporated into the work for this project were produced in the United States of America, with the only exceptions as noted below.

As required, we will maintain all records and documents pertinent to the Build America, Buy America Act requirements, at the address given above, for not less than 3 years from the date of Final Acceptance. These files will be available for inspection and verification by the Maine Department of Transportation and/or the Federal Highway Administration.

We further certify that the total value of foreign steel and iron for this project is \$ _____, said value being less than 0.1% of the total construction contract price or \$2,500.00, whichever is greater.

December 12, 2025

We further certify that the total material cost of foreign Manufactured Products and Construction Materials for this project is \$_____, said value being no more than the lesser of \$1,000,000 or 5% of total applicable costs. The term “total applicable costs” is defined as the total actual final material cost of the compliant and non-compliant iron and steel, Manufactured Products, and Construction Materials.

Signed (*Contractor*)
(*President*) (*Contractor Firm*)

MaineDOT DBE Project Attainment Target (PAT)
for this Project is 0 %

The MaineDOT seeks to meet the specified annual Disadvantaged Business Enterprise (DBE) usage goal set out by 49 CFR 26.45 through the efforts of contractors seeking to employ qualified DBE subcontractors. We seek to meet this goal by race neutral means and do not, at this time, use contract specific requirements for each project. We do however, understand the capacity of Maine's DBE community and the unique characteristics a project may have that would differ from the broad annual goal.

Taking this into consideration, the MaineDOT will review each project and develop an anticipated attainment or Project Attainment Target (PAT) based on several factors that are project specific. Those factors include:

- Scope of Work
- DBE availability according to Specification Item
- Geographic location
- DBE capacity

This PAT is developed to assist contractors to better understand the DBE participation that the MaineDOT can reasonably expect for a specific project. The PAT is NOT a mandate but an assessment of the DBE opportunities that this project could meet or exceed. MaineDOT anticipates that each contractor will make the best effort to reach or exceed the PAT for this project.

SPECIAL PROVISION
SECTION 107
TIME
(Contract Time)

The Contractor shall be allowed to commence Work provided that all required plans/submittals have been received and determined to be acceptable by the Department.

The specified Contract Completion Date is **October 23, 2026**. All Work must be Complete by the Contract Completion Date and within the Contract Time. The Contract Time shall be all time between the Contract Execution and the Contract Completion date specified in the Contract, and any authorized extensions. The specified Contract Expiration Date is **December 31, 2026**. All work shall have received final acceptance and all Closeout documentation required by the Department must be complete and accepted for retainage to be released. Except as expressly provided otherwise in this Contract, the Contractor or, in case of default, its Surety, shall owe the Department the per diem amount specified in Section 107.7.2 - Schedule of Liquidated Damages, as well as any per diem amount of Supplemental Liquidated Damages as specified in the Supplement Specifications, for each Calendar Day that any portion of the Work remains incomplete after the Contract Time has expired.

Contract Expiration Date The date by which (1) Closeout Documentation shall be complete, (2) Work shall have received final acceptance, (3) All Work pursuant to the Contract shall be complete, except the landscape establishment period and warranty work, (4) All contract documentation and submittals shall be complete and accepted, and (5) Retent paid. The Contract Expiration Date is usually included in Special Provision 107 and on the Contract Agreement, Offer, & Award form.

Night Work. If the Contractor performs Work during periods of darkness, the Contractor shall comply with Contract requirements governing night Work, including but not limited to Section 652.6.2 Night Work. If the Contractor elects to perform Work during periods of darkness on its own initiative and without direction from the Department, then the Contractor shall also comply with all municipal ordinances affecting such Work, including noise ordinances. When pricing and scheduling the Work, the Contractor shall not assume that such non-directed night Work will be allowed. Accordingly, the Contractor shall not be entitled to any adjustment to either compensation or time due to its inability to secure any required municipal approvals.

The Contractor shall stop Work and shall have all lanes open to traffic on **May 22, 2026, at 2:00 PM** and shall not resume work until **May 26, 2026**, due to the Memorial Day holiday weekend.

The Contractor shall stop Work and shall have all lanes open to traffic on **July 2, 2026, at 2:00 PM** and shall not resume work until **July 6, 2026**, due to the Independence Day holiday weekend.

The Contractor shall stop Work and shall have all lanes open to traffic on, **September 4, 2026, at 2:00 PM** and shall not resume work until **September 8, 2026**, due to the Labor Day holiday weekend.

Liquidated Damages will be assessed for each Calendar Day that any portion of the Work remains incomplete, and each Calendar Day that repairs of painted markings failing reflectivity test are being performed, beyond the specified Contract Completion Date. Liquidated Damages will not be assessed during days that all Work is complete, but the Department has not completed the inspection of the Work.

All work schedule changes must be submitted for approval to the Department a minimum of 10 calendar days prior to the requested change.

SPECIAL PROVISION INVOICES, PAYMENTS AND PROJECT CLOSEOUT

Payment Method

The Payment Method is the method of establishing quantities and the amount due for payments needed to correlate with Department's internal financial system requirements for payment processing. Either the Department will estimate the amount of Work performed and make payment based upon such estimates or the Contractor shall submit an itemized invoices to the Department. The Department will determine which Payment Method will be used and will notify the Contractor. The Department may change the Payment Method during the contract.

Department Generated Quantities Payment Method

The Department will estimate the amount of Work performed at contract prices and use these to generate payments. The Contractor shall not submit invoices.

Contractor Submitted Invoice Payment Method

If the Department determines that the Contractor shall submit itemized invoices, then the following provisions apply.

The Contractor shall submit an itemized invoice to the Department for services monthly and at the completion of the Work or as otherwise noted in the Contract documents for approval and payment. Invoices may be paid once every two weeks if, in the opinion of the Department, the amount of Work performed is sufficient to warrant such payment.

At a minimum, invoices shall be on a Contractor's letterhead and shall include the following information:

- Contractor name, address & Contract Number
- Invoice Date & Number,
- Period during which Work was performed.
- Description and Location of Work.,
- Quantities at the Prices contained in the Contractor's Bid,
- Extra Work agreed to by written Contract Modification,
- Total amount due.

The Department will make payments based upon approved complete and correct invoices for accepted Work invoiced at bid prices. No such payments will be made if, in the judgment of the Department, the Work is not proceeding in accordance with the

provisions of the Contract. The Department may not make payments when the total value of the Work performed since the last payment amounts to less than \$5,000.

The Department may measure items for verification of quantities in accordance with the "Method of Measurement" provisions of the applicable Specification. Measurement of Bid Items shall include all resources necessary to complete the Pay Item of Work under the Contract. For all items of Work, other than those paid for by lump sum, the Department shall determine the quantities accepted as the basis for Final Payment after the Physical Work is Completed.

If the Department determines the Work substantially conforms to the Contract, the Department may accept the Non-conforming Work and may require a credit to the Department to be deducted from amounts otherwise due the Contractor. If the Department and Contractor cannot agree to the amount of the credit, the work shall be Unacceptable Work.

Payments to the Contractor shall be full compensation for furnishing all labor, equipment, materials, services, and incidentals used to perform all Work under the Contract in a complete and acceptable manner, and for all risk, loss, damage, or expense of any kind arising from the nature or execution of the Work. The Contractor shall pay all taxes, charges, fees, and allowances. Except as expressly provided otherwise in this Contract, all such taxes, charges, fees, and allowances are Incidental to the Contract. Most items are exempt from Maine sales tax. The Contractor shall Bid in accordance with the Maine statutory exemption from sales tax. No payments due the Contractor will be adjusted for inflation. No interest shall be due and payable on any payment due the Contractor. The Department may require that the Contractor submit backup documentation including copies of receipts, invoices, and itemized payments to Subcontractors.

Should the Contractor or its Surety fail to complete the Work by the Completion date, a deduction of the amount stipulated in the Contract as Liquidated and Supplemental Liquidated Damages will be made for each and every Calendar Day that such Work remains uncompleted. This amount will be deducted from any money due the Contractor or its Surety under the Contract, and the Contractor and its Surety will be liable for any Liquidated and Supplemental Liquidated Damages in excess of the amount due.

The Department may withhold or reduce payments claimed by the Contractor on account of:

- Incomplete, Inaccurate or Incorrect Invoices,
- Defective Work, Unacceptable Work, Unauthorized Work, Uninspected Work and/or Non-conforming Work,
- Failure by the Contractor to follow the Contracts 652 Special Provisions and/or The Manual on Uniform Traffic Control Devices (MUTCD) and/or The Contractors own Traffic Control Plan will result in a reduction in payment, computed by reducing The Lump Sum Total by 5% per occurrence,

- Failure by the Contractor to follow Standard Specification Section – 656 and/or the Contractor’s own Soil Erosion and Water Pollution Control Plan (SEWPCP) resulting in a violation letter and a reduction in payment,
- Liquidated Damages and/or Supplemental Liquidated Damages,
- Pay adjustments for cast-in-place concrete and/or Hot Mix Asphalt quality level
- Damages for Non-conforming, Defective or Unauthorized Work or Equipment,
- Damage to a third party,
- Claims filed or reasonable evidence indicating probable filing of claims,
- Failure of the Contractor to make payments to Subcontractors or for Materials or labor,
- Regulatory non-compliance or enforcement,
- Failure to submit Documentation
- Failure to submit Closeout Documentation,
- Failure to provide the Department the opportunity to inspect the Work,
- Substantial evidence that the Project cannot be completed for the unpaid balance,
- Substantial evidence that the amount due the Department will exceed the unpaid balance,
- Retainage,
- All other causes that the Department reasonably determines negatively affect the State’s interest.

The Department will pay 100% of each approved Progress Payment until the Work is approximately 50% complete. Thereafter, the Department will deduct 5% of the amount of each Progress Payment as retainage. In the event that the Department believes that the retainage will be insufficient to cover the Contractor’s obligations under this Contract, the Department may withhold a greater percentage of the money to cover Contractor obligations. The Department may hold, temporarily or permanently, retainage as needed to assure timely Completion of the Work and payment of all Subcontractors and Suppliers in Conformity with the Contract. Upon Final Acceptance, the Contractor may request that the Department reduce retainage. The Department may grant or deny such request as it deems desirable and prudent. Otherwise, retainage will be held until the receipt of all Closeout Documentation.

In order for the Department to make payments, the Department may require the Contractor to submit invoices reflecting all the deductions determined by the Department.

Project Closeout

The Contractor shall notify the Department in writing that it considers the Project complete. The Department will notify the Contractor in writing that the Physical Work is Complete and in Conformity with the Contract and that the Project will be Finally Accepted when documentation required is received from the Contractor. The Contractor shall deliver the final invoice, the 106 Memo, the Materials Certification, the All Bills Paid Letter, and any other required Closeout documentation, all as applicable, to the Department within 30 Days of the date of the notification that the Physical Work is Complete. Liquidated Damages will cease upon the physical completion of the Work.

Within 75 Days of the receipt of these documents, the Department will advise the Contractor in writing if the Department is not in concurrence with the final invoice and any damages to be assessed for the Project. The Contractor shall resolve any Project issues that remain and provide a corrected final invoice, as applicable, to the Department within 30 Days. Completion occurs when the Contractor has finished all Work pursuant to the Contract, including Delivery and acceptance of all Documentation. Completion does not mean substantial Completion. Completion also does not mean Completion of Physical Work. The Department will make Final Payment, including the release of all remaining retainage following Completion, when the Work is complete and has undergone a successful final inspection and all documentation is complete.

The Acceptance by the Contractor of the final payment, as evidenced by cashing of the final payment check, constitutes a release to the Department from all claims and liability under the Contract. Upon Final Acceptance, the Contractor is released from further obligation, except for warranty obligations provided for in this Contract.

SPECIAL PROVISION
SECTION 627
PAVEMENT MARKINGS

627.01 Description This work shall consist of furnishing all material, labor, equipment and traffic control to place reflectorized pavement lines and markings, removing associated pavement lines and markings, and furnishing and applying reflectorized paint to pavement and curbing in reasonably close conformity with the locations and diagrams contained in the Contract and as designated.

627.02 Materials Materials shall conform to the requirements specified in the following Sections of Division 700 - Materials.

Pavement Marking Paint 708.03

The Pavement Marking material used shall be one of the products listed on the Maine Department of Transportation qualified products list.

627.04 General The Department will be responsible for providing the Contractor with all proper documentation of paint project and paving in the area of the contract to be painted.

The size and shape of all stencils are to be the same as standard MaineDOT stencils. Upon request, the MaineDOT will supply stencils or dimensions. The Contractor shall be responsible for any and all damages and losses of all stencils that are supplied to the Contractor by the Department, before they are returned.

The Contractor shall follow the manufacturer's recommendations regarding pavement and ambient temperature at the time of application. The Department may verify the pavement and ambient temperatures when deemed necessary.

All pavement lines and markings shall be applied in accordance with the Manual on Uniform Traffic Control Devices.

Longitudinal lines placed on tangent roadway segments shall be straight and true. Longitudinal lines placed on curves shall be continuous smoothly curved lines consistent with the roadway alignment.

Newly painted lines, markings and curb shall be protected from traffic by the use of cones, stationary vehicles or other approved methods until the paint is dry.

The Contractor shall be responsible for removing all excess beads from the roadway after finishing each project location.

The Contractor shall remove and replace all unsatisfactory Pavement Markings at no cost to the Department. Unsatisfactory Pavement Markings include but are not limited to the pavement markings that have drag marks, gashes, gouges, foreign covering, discolored areas or areas that have failed to solidify, have improper adhesion, length or thickness, less reflectivity that required by this contract, have areas that present ragged appearance, that that do not present sharply defined edges, or areas with abrupt unintended changes in alignment.

All paint claims resulting from work by the Contractor shall be the sole responsibility of the Contractor.

The Department may add or delete pavement markings and/or stencils and the Department may add or delete locations.

627.05 Preparation of Surface Immediately before applying the pavement marking paint to the pavement or curb, the surface shall be dry and entirely free from dirt, grease, oil, or other foreign matter.

627.06 Application Paint shall be applied in a manner to meet the retro-reflectivity standards listed below.

Yellow shall meet a minimum reflectivity of 150 millicandelas. All locations not meeting minimum standards will require repainting of the section(s) in question.

White shall meet a minimum reflectivity of 250 millicandelas. All locations not meeting minimum standards will require repainting of the section(s) in question.

Pavement Marking shall meet a minimum of 15 to 16 mils. All locations not meeting minimum standards will require repainting of the section(s) in question.

Glass beads shall be applied to the stencil marking at the rate of 6 to 8 lbs./gal of paint and in sufficient quantity to assure complete and uniform coverage of hand painted surfaces.

The Department will inspect all projects between one and four weeks after the Contractor notifies the Department of completion, the Contractor will be notified of all failing reflectivity test results.

The Contractor will contact the Transportation Operations Manager and Supervisor of the MaineDOT paint crew on weekly basis and inform them of any work performed and completed.

627.08 Removing Lines and Markings The Department will identify any pavement markings to be removed. If the Contractor determines any pavement markings that should be removed, they shall notify the Department and receive approval, prior to performing Work. When removing pavement lines and markings, it shall be done by high pressure water, sand blasting, solvent or other acceptable means. The method chosen must be capable of completely eradicating the

existing line or marking without damage to the pavement. Burning and grinding to remove temporary markings from final pavement or from existing pavement not to be resurfaced will not be permitted.

627.09 Method of Measurement The quantity of permanent pavement and curb markings measured for payment will be the number of square feet shown in the Schedule of Items in the contract. This quantity will be considered final and no adjustments will be made except when changes resulting in increases or decreases are made by the Department. Quantities included in the plan quantity amount but not accomplished will be calculated by the Department using standard estimating procedures and deducted from the plan quantity. Pavement and curb markings not included in the plan quantity amount but authorized by the Department and completed, will be measured or computed by the square foot of curb or surface actually painted and reflectorized and added to the plan quantity.

The accepted quantity of removing existing pavement markings will be measured by the square foot. Pavement markings removed due to the Contractor painting errors will not be measured for payment.

627.10 Basis of Payment The accepted quantity of permanent pavement and curb markings will be paid for at the Contract unit price per square foot and include all material, labor, equipment and maintenance of traffic control necessary to perform the Work as prescribed in the Contract. No adjustment will be made to the quantity for payment, except as described under Method of Measurement above. All other permanent pavement and curb markings will be paid for at the Contract unit price per square foot.

The accepted quantity of removing existing pavement markings will be paid for at the Contract unit price per square foot and include removing pavement lines, all material, labor, equipment and maintenance of traffic control necessary to perform the Work as prescribed in the Contract.

Payment will be made under:

<u>Pay Item</u>	<u>Pay Unit</u>
627.75 White or Yellow Pavement & Curb Marking	Square Foot
627.77 Removing Existing Pavement Marking	Square Foot

Region 1,2,3

2026

Region	Square Feet
1	4653
2	15678
3	17865
Total	38196

Railroad Crossing

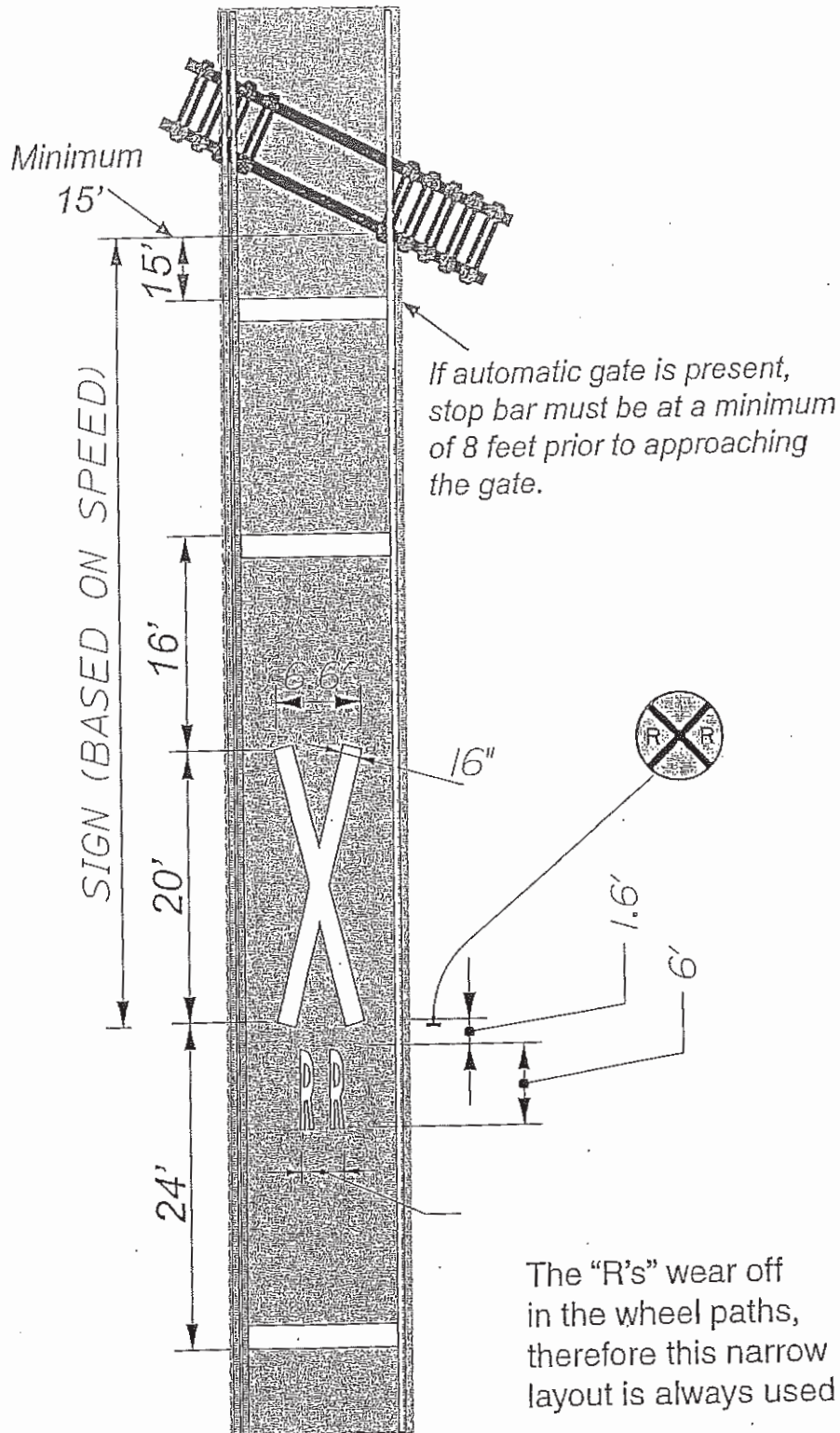

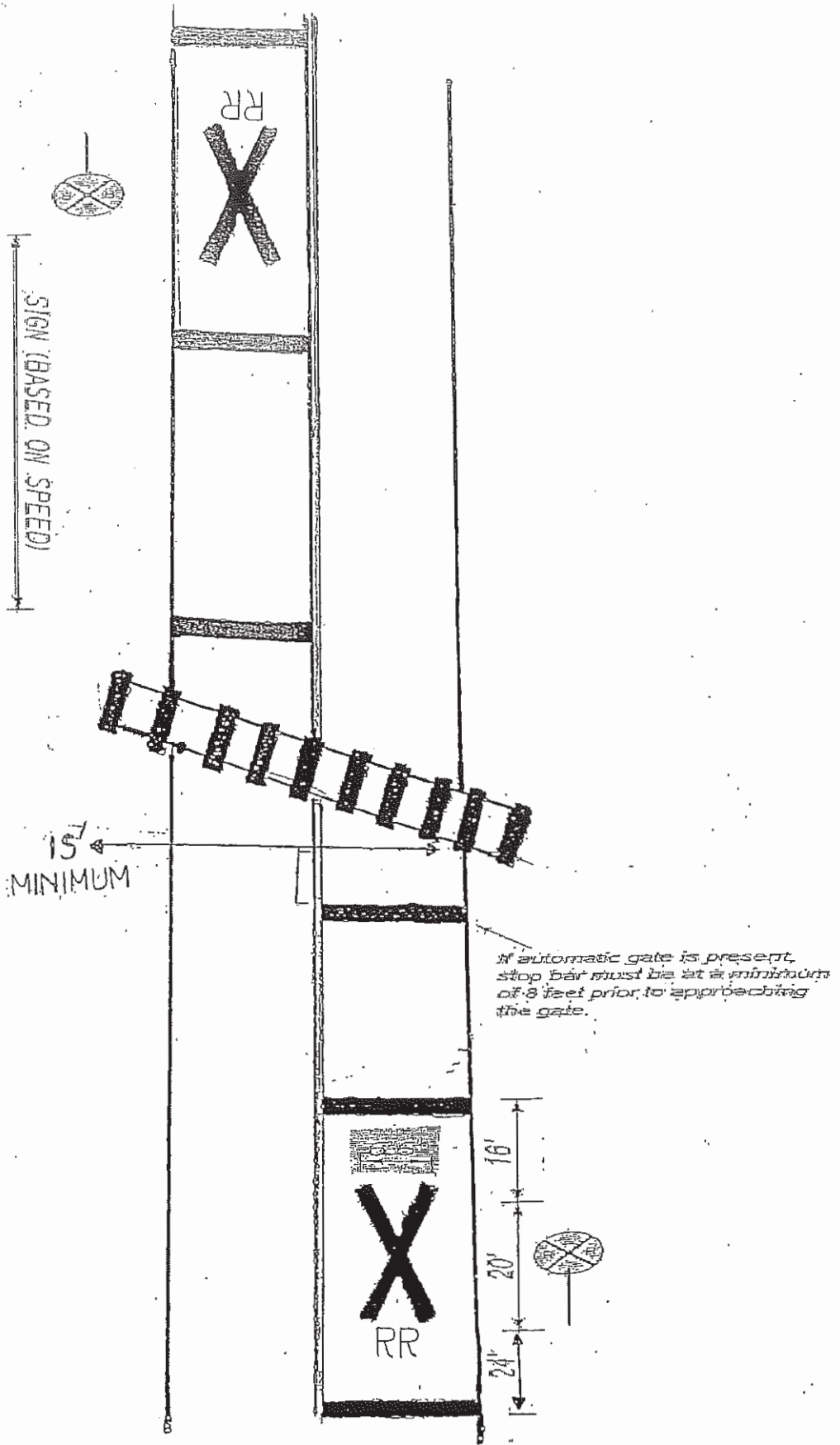

LANE REDUCTION ARROW

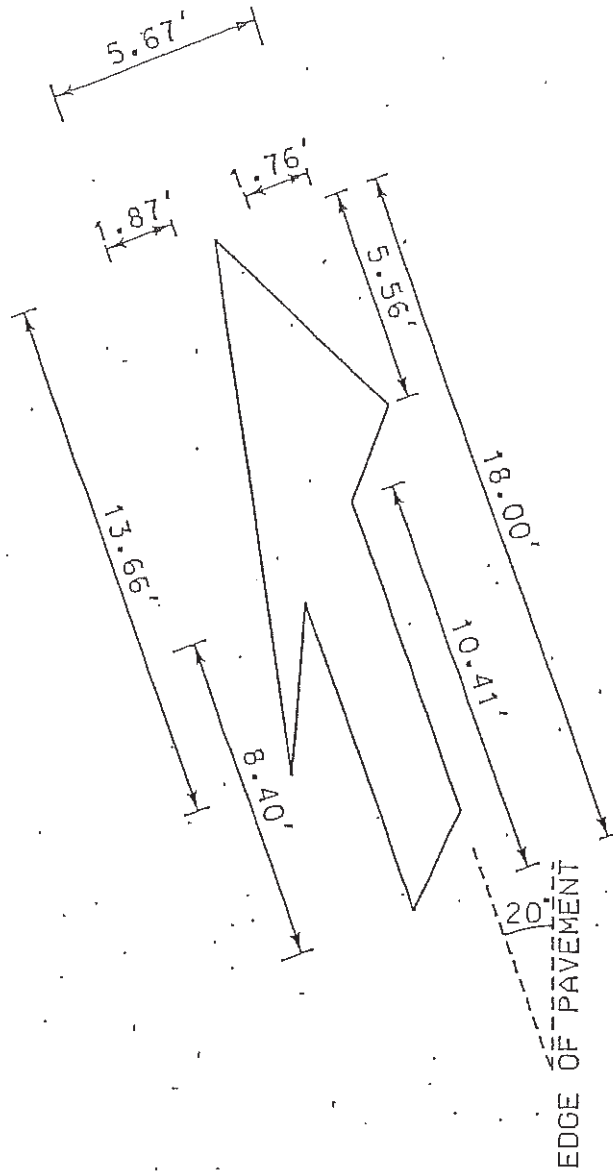

37.90 Square Feet.

PROPORTIONATE
NOT TO SCALE

OF 1

1

SHEET NUMBER

DATE	BY	CHKD

REV.

1

A – Lane reduction

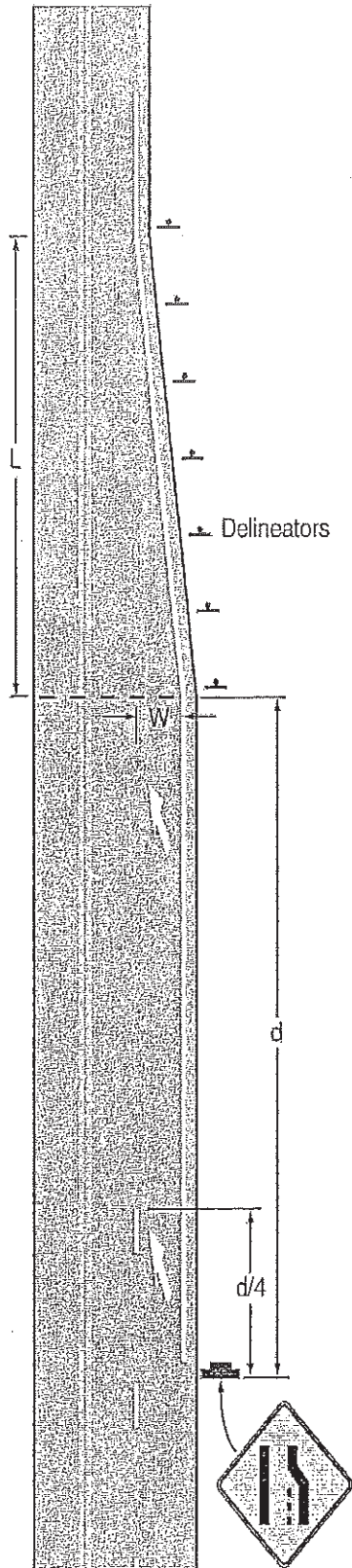

B – Lane reduction with lateral shift to the left

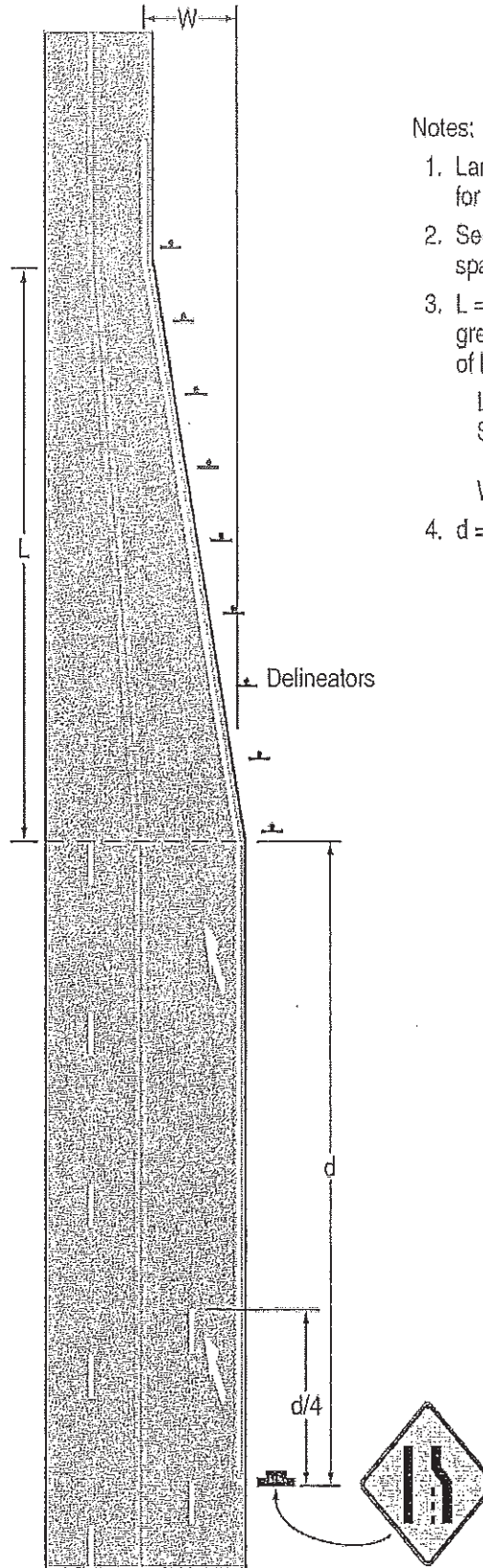

Notes:

1. Lane-reduction arrows are optional for speeds of less than 45 mph
2. See Section 3F.04 for delineator spacing
3. $L = WS$ for speeds of 45 mph or greater and $L = WS^2/60$ for speeds of less than 45 mph, where:
 L = Length of taper in feet
 S = Posted, 85th-percentile, or statutory speed in mph
 W = Offset in feet
4. d = Advance warning distance (see Section 2C.05)

Region 1 Pavement Markings

Town	Asset #	Square Feet	Location	Map#	Type
Auburn	904870	336	Hotel & Kittyhawk	5	Intersection
Auburn	903912	492	4 & Danville Corner	5	Intersection
Auburn	1102726	116	Kittyhawk+ 202	5	Intersection
Cumberland	904005	506	26 & Castle Rock Rd.	5	Intersection
Cumberland	904683	260	Main St.	5	RailRoad
Gray	904688	260	Depot Rd.	5	RailRoad
New Gloucester	904693	260	Yarmouth Rd.	5	RailRoad
New Gloucester	904696	260	New Gloucester Rd.	5	RailRoad
North Yarmouth	1003097	184	231+North Rd+Mill Rd	5	Intersection
North Yarmouth	904099	227	9 & 115	5	Intersection
North Yarmouth	904104	295	9 & North Rd.	5	Intersection
North Yarmouth	1071310	42	115+231	5	Intersection
North Yarmouth	904708	260	Dunn's Corner	5	RailRoad
North Yarmouth	904712	260	North St.	5	RailRoad
North Yarmouth	904710	260	North St.	5	RailRoad
Poland	904714	260	Empire Rd.	5	RailRoad
Pownal Ctr.	904130	375	9 & S.A.	5	Intersection
Total Square feet		4653			

904870

PAVEMENT MARKINGS

Project No. _____

DESCRIPTION OF WORK DONE

STRAIGHT ARROW _____	LANE LINE _____
TURN ARROW _____	STOP _____
STOP BAR <u>184</u>	ONLY _____
CURBING-YELLOW _____	STOP AHEAD <u>152</u>
WHITE _____	CROSSWALKS _____
HASH MARKS _____	TOTAL SQ. FT. <u>336</u>
MISC. _____	

DIAGRAM OF WORK

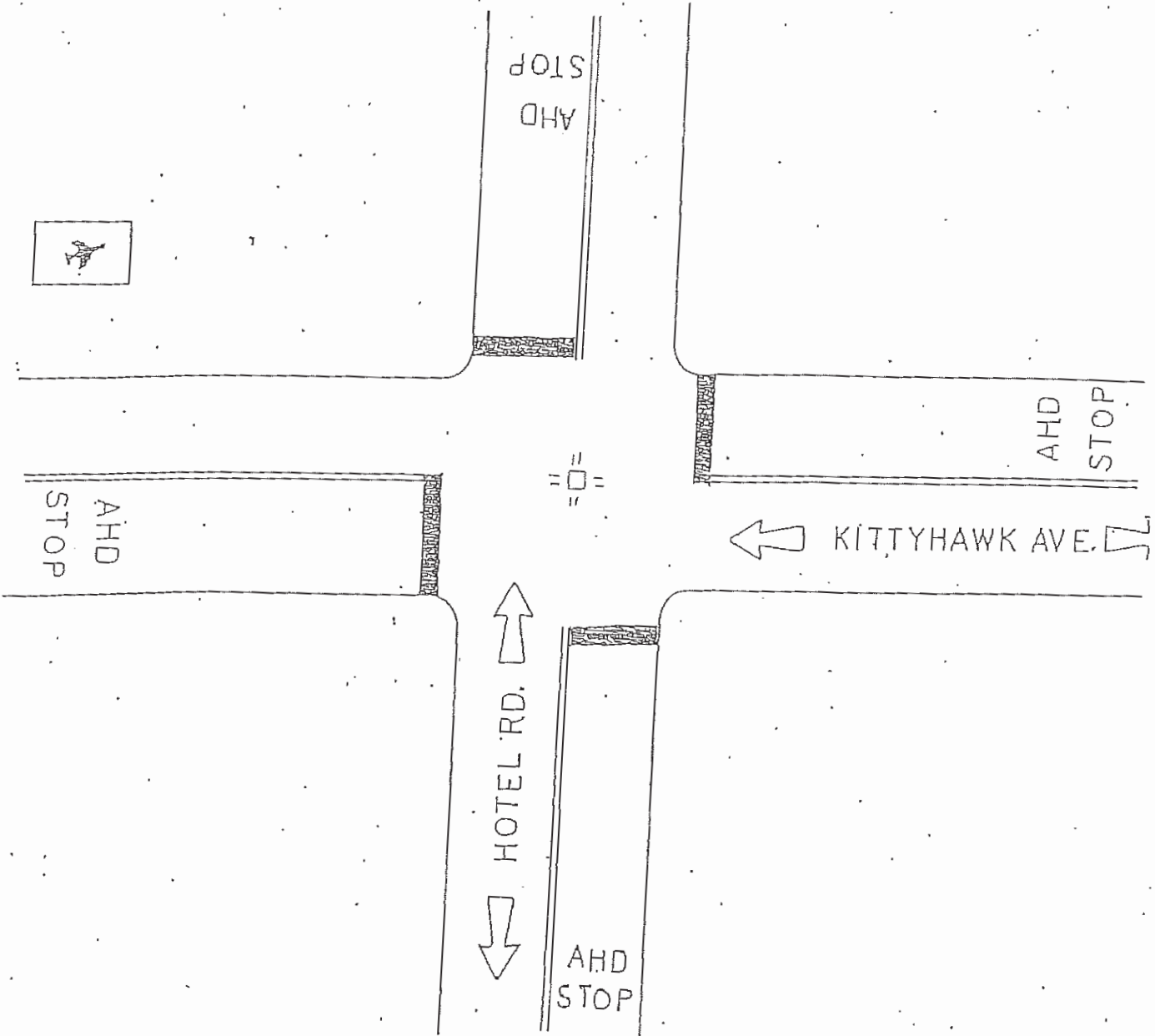

CREW LEADER _____ YES NO
 PROJECT DONE BEFORE _____
 DATE _____

REGION, 1

TOWN AUBURN
 ROUTE OR KITTYHAWK AVE.
 ROAD NO. & HOTEL RD.

STRAIGHT ARROW _____
 TURN ARROW 192
 STOP BAR _____
 CURBING-YELLOW _____
 WHITE _____
 HASH MARKS _____
 MISC. CHERONS 300

LANE LINE _____
 STOP _____
 ONLY _____
 STOP AHEAD _____
 CROSSWALKS _____
 TOTAL SQ. FT. 492

903912



BEECH HILL RD.

DANVILLE CORNER RD

1/8 MILE

1/8 MILE

4 & 100 & 202

TURNPIKE

DIVISION I
 TOWN AUBURN
 ROUTE OR 4 & DANVILLE
 ROAD NO. CORNER RD. 129

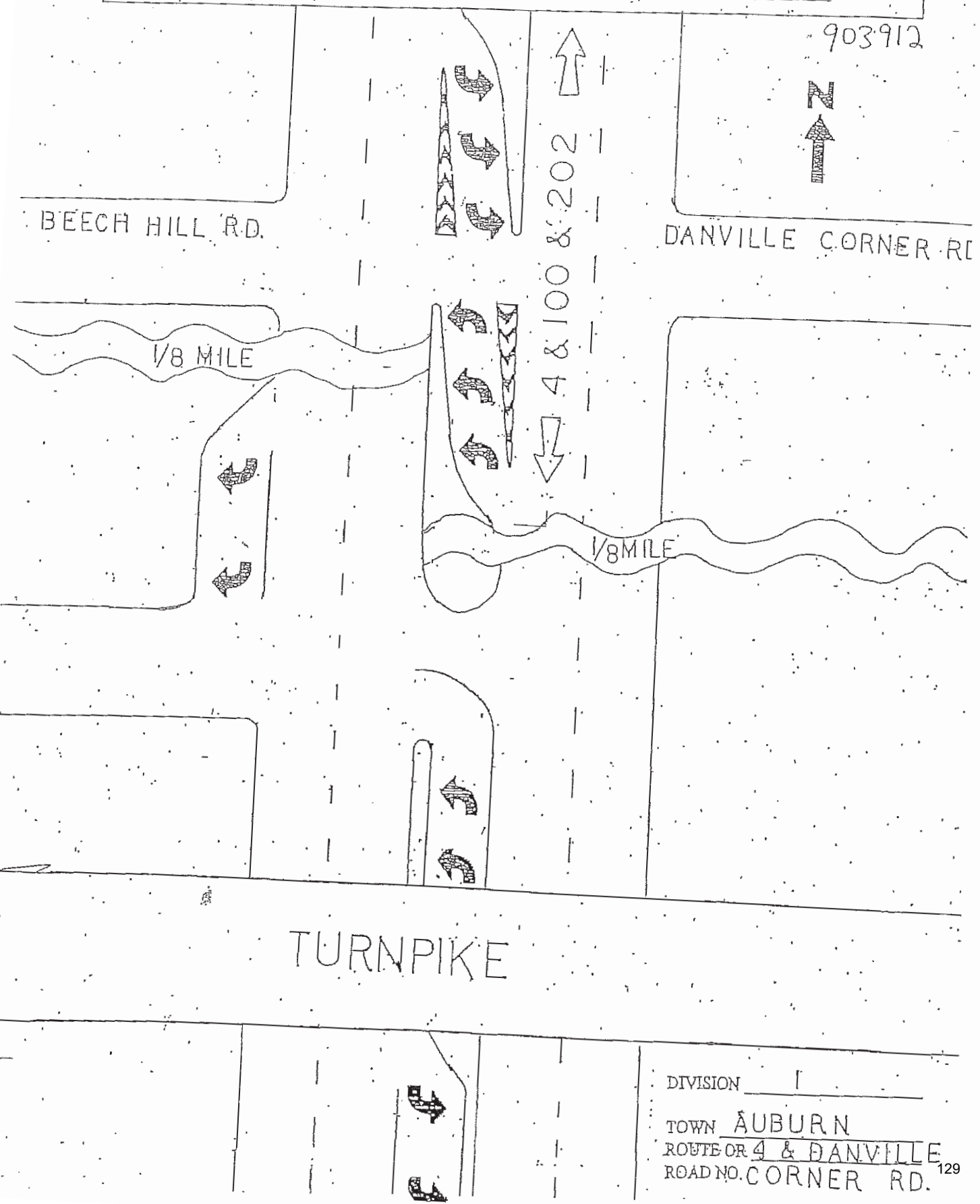

PAVEMENT MARKINGS

Project No. _____

DESCRIPTION OF WORK DONE

Auburn	Asset: 1102726
Total Sq. Feet: 116	Kitty Hawk Ave
Turn Arrows: 32	
Lane Reduction Arrow: 84	

DIAGRAM OF WORK

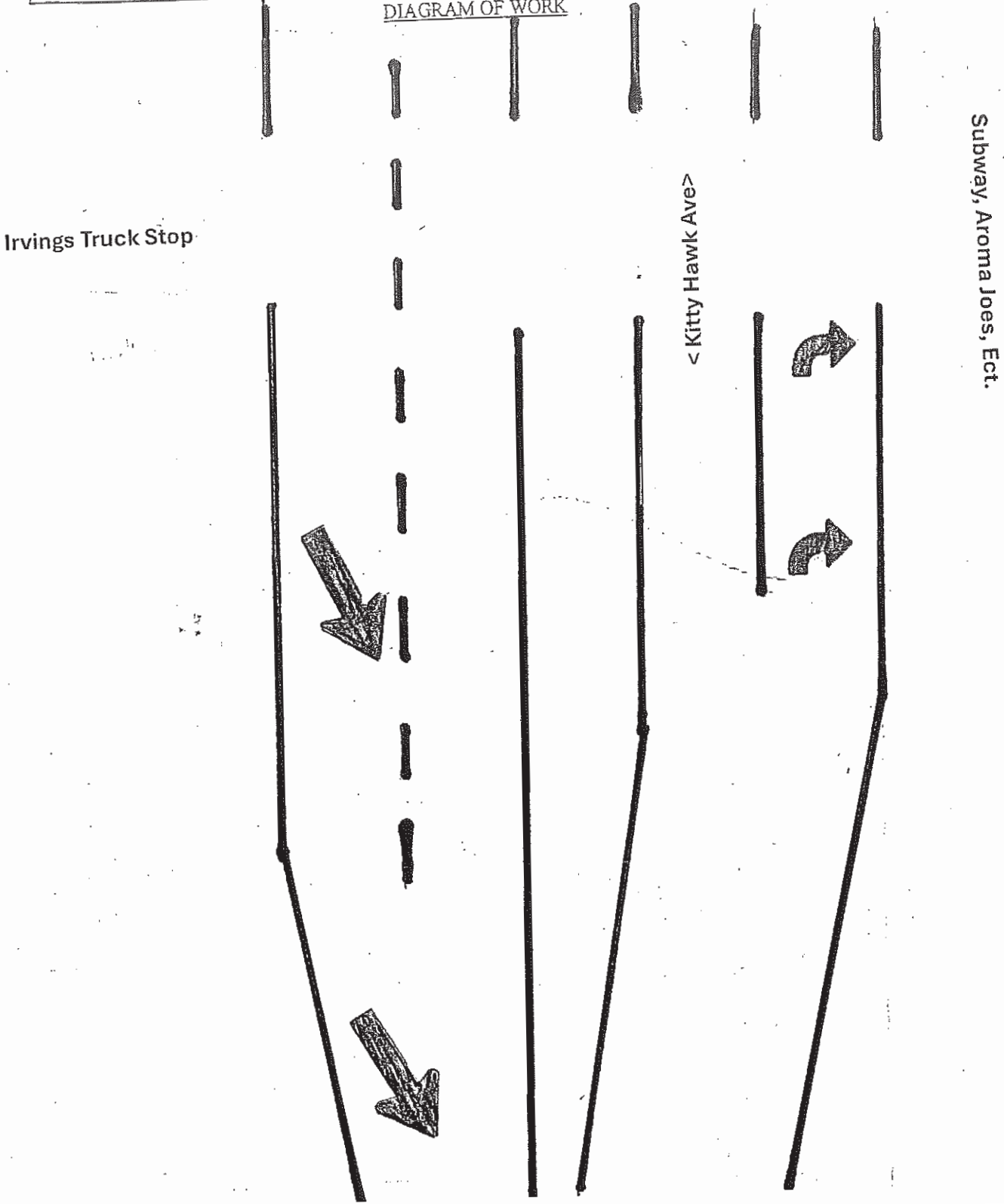

Stores:

Subway, Aroma Joes, Ect.

PAVEMENT MARKINGS

Project No. _____

DESCRIPTION OF WORK DONE

Cumberland	Asset: 904005
Total Sq. Feet: 506	Location: 26+100+Castle Rock Rd
Turn Arrows: 240	Don't Paint Stop Bar on Side Roads
Yellow Hash: 266	

DIAGRAM OF WORK

6 Sets of Center Turn lane Arrows

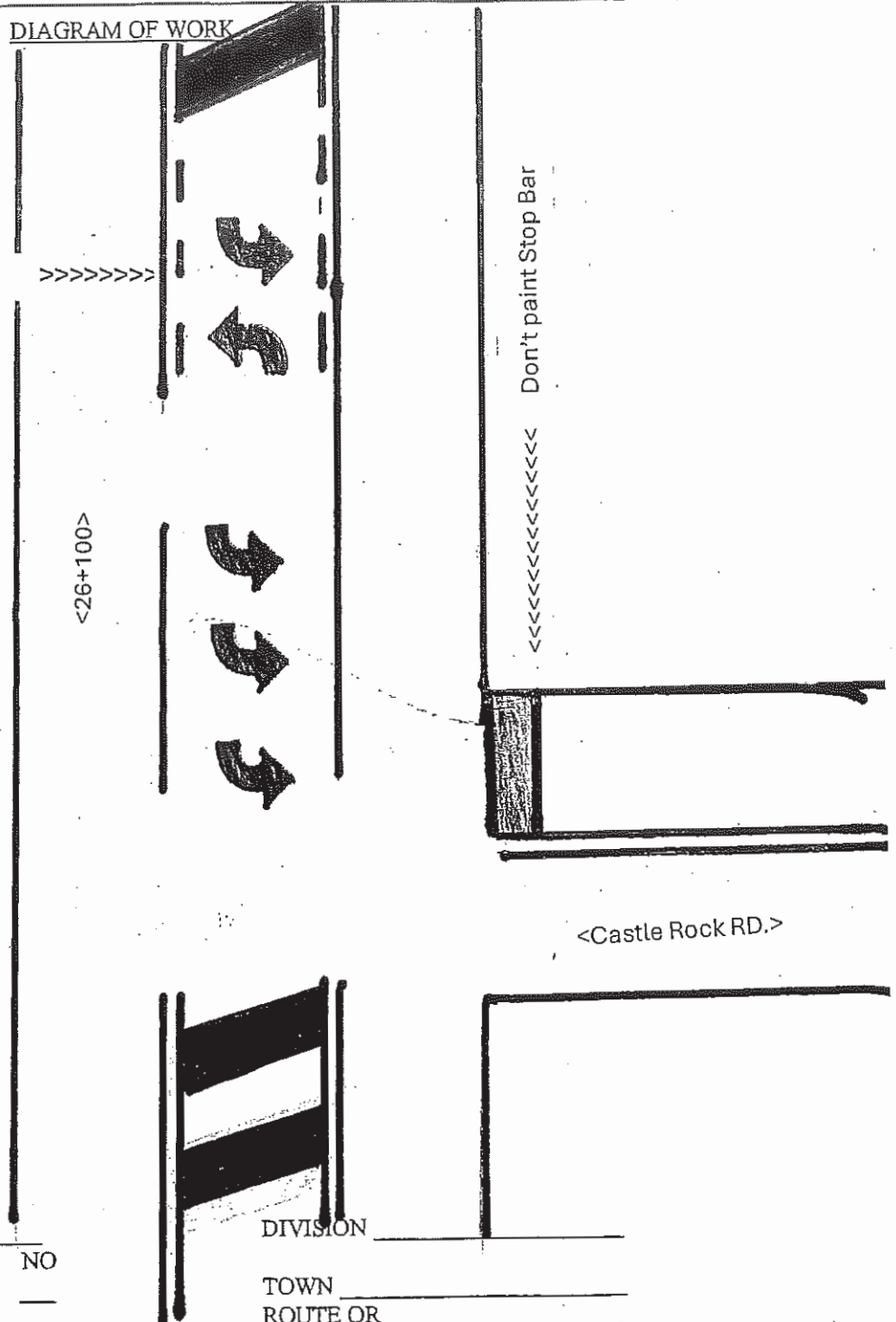

CREW LEADER _____
PROJECT DONE BEFORE _____
DATE _____
ACTUAL JOB TIME _____

DIVISION _____
TOWN _____
ROUTE OR _____
ROAD NO. _____

PAVEMENT MARKINGS

Project No. _____

DESCRIPTION OF WORK DONE

North Yarmouth

Asset: 1003097

Total Sq. Feet: 184

Stop Bar: 76

231+North Rd+ Mill Rd.

Stop: 44

Map 5

Stop AHD: 64

Don't paint North Rd or Mill Rd. Only Route 231

DIAGRAM OF WORK

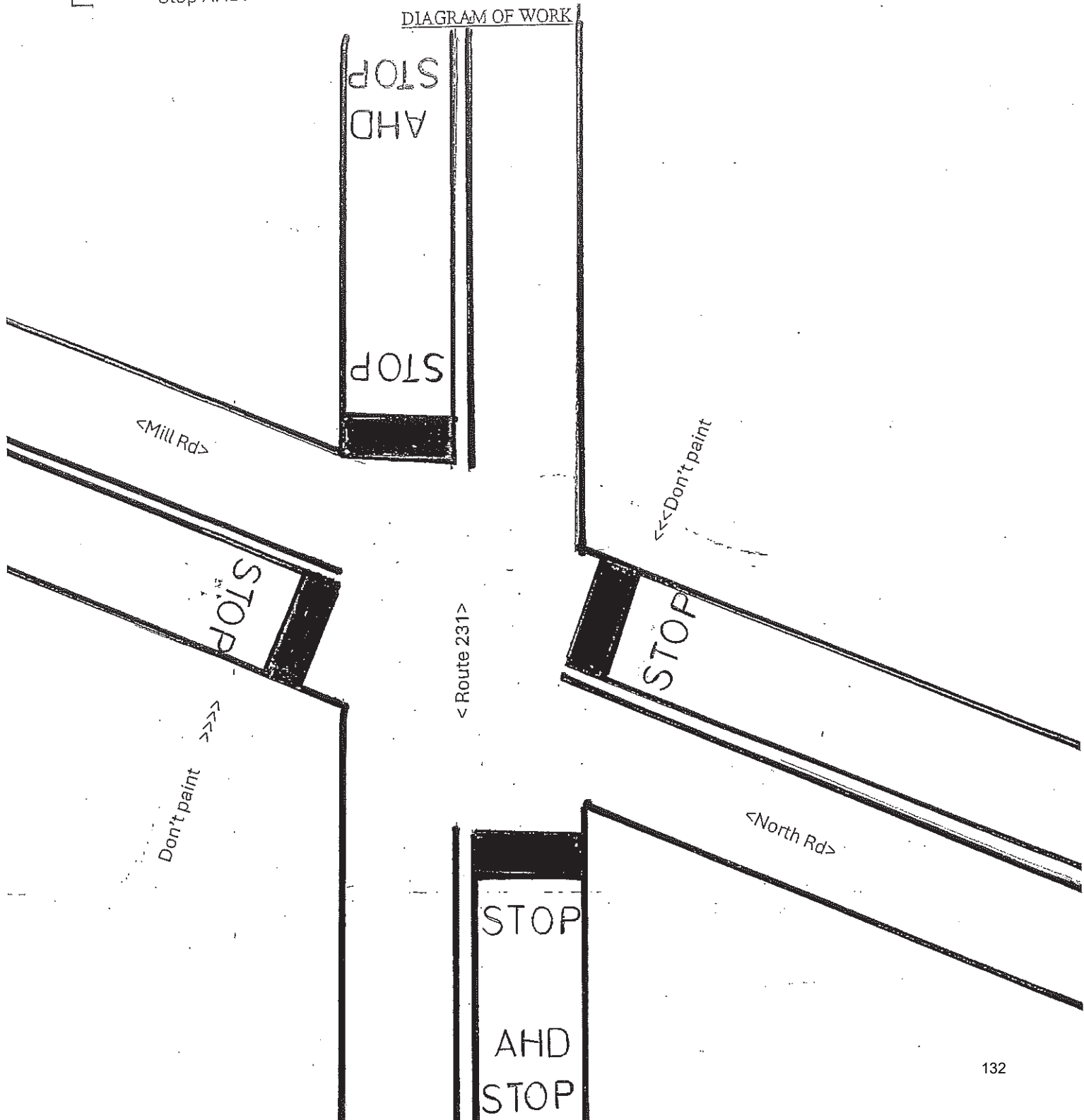

904099

PAVEMENT MARKINGS

Project No. _____

DESCRIPTION OF WORK DONE

STRAIGHT ARROW _____	LANE LINE _____
TURN ARROW _____	STOP _____
STOP BAR <u>153</u>	ONLY _____
CURBING-YELLOW _____	STOP AHEAD <u>74</u>
WHITE _____	CROSSWALKS _____
HASH MARKS _____	TOTAL SQ. FT. <u>227</u>
MISC. _____	

DIAGRAM OF WORK

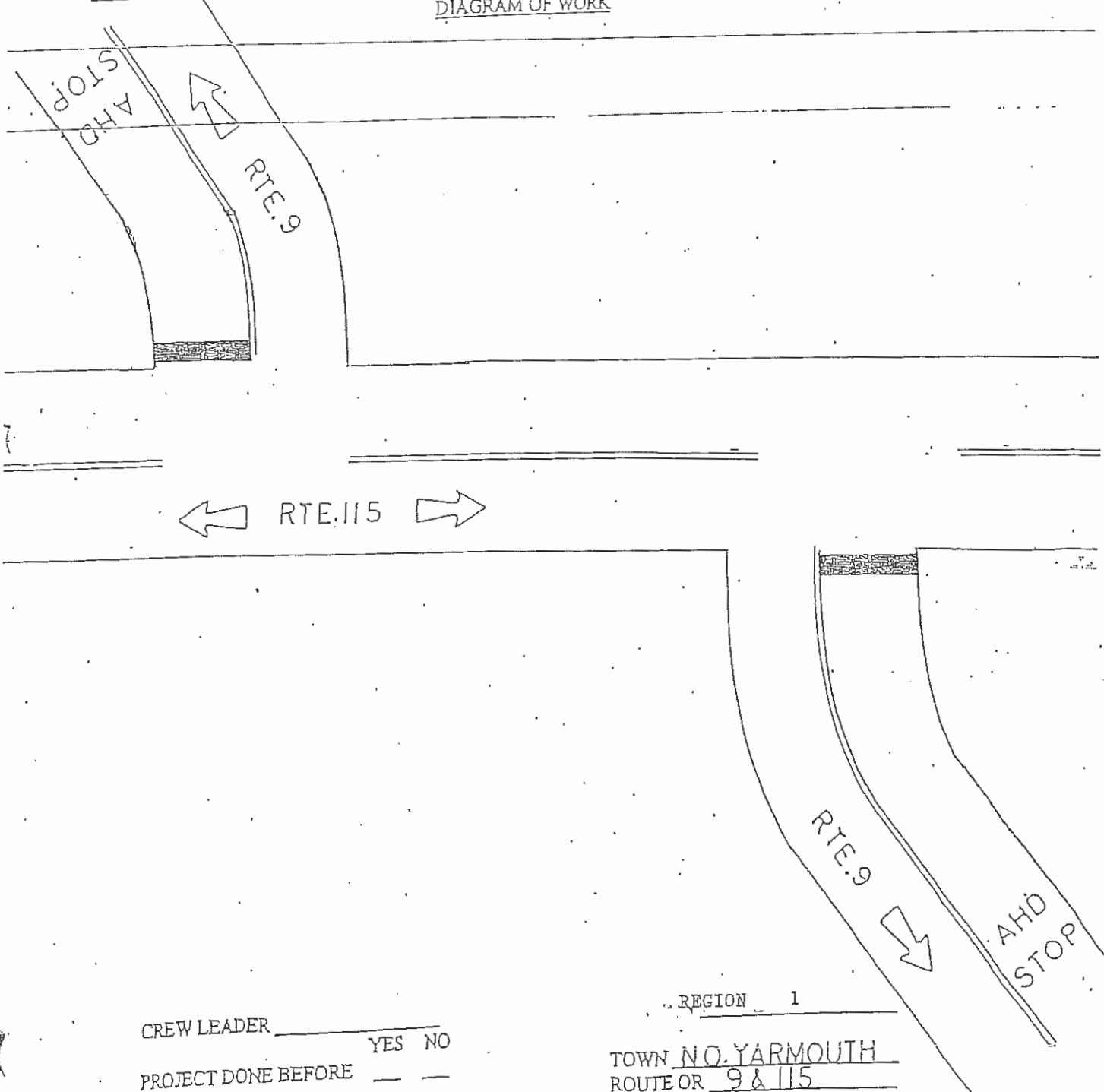

CREW LEADER _____
 PROJECT DONE BEFORE YES NO
 DATE _____
 ACTUAL JOB TIME _____

REGION 1
 TOWN NO. YARMOUTH
 ROUTE OR 9 & 115
 ROAD NO. _____

PAVEMENT MARKINGS

904104

Project No. _____

DESCRIPTION OF WORK DONE

STRAIGHT ARROW _____	LANE LINE _____
TURN ARROW _____	STOP <u>88</u>
STOP BAR <u>96</u>	ONLY _____
CURBING-YELLOW _____	STOP AHEAD <u>111</u>
WHITE _____	CROSSWALKS _____
HASH MARKS _____	TOTAL SQ. FT. <u>295</u>
MISC. _____	

DIAGRAM OF WORK

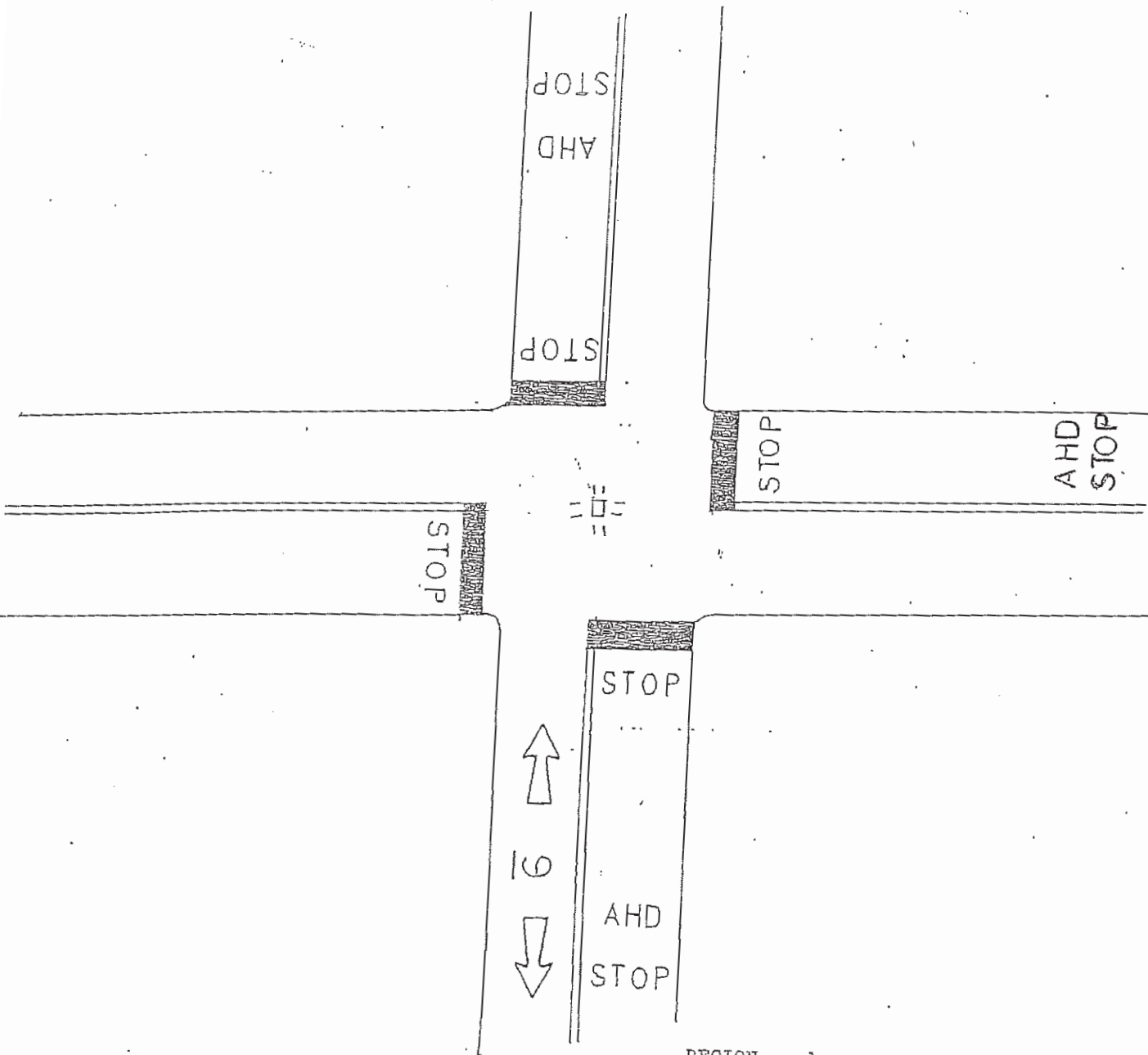

CREW LEADER _____

REGION 1

YES NO

PROJECT DONE BEFORE _____

DATE _____

ACTUAL JOB TIME _____

TOWN N.O. YARMOUTH
 ROUTE OR 9 & NORTH RD.
 ROAD NO. _____

PAVEMENT MARKINGS

Project No. _____

DESCRIPTION OF WORK DONE

North Yarmouth

Asset: 1071310

Total Sq. Feet: 42

Stop Bar: 42

Map: 5

Location: 115+231

Stop Bar

DIAGRAM OF WORK

<Route 115>

<Route 231>

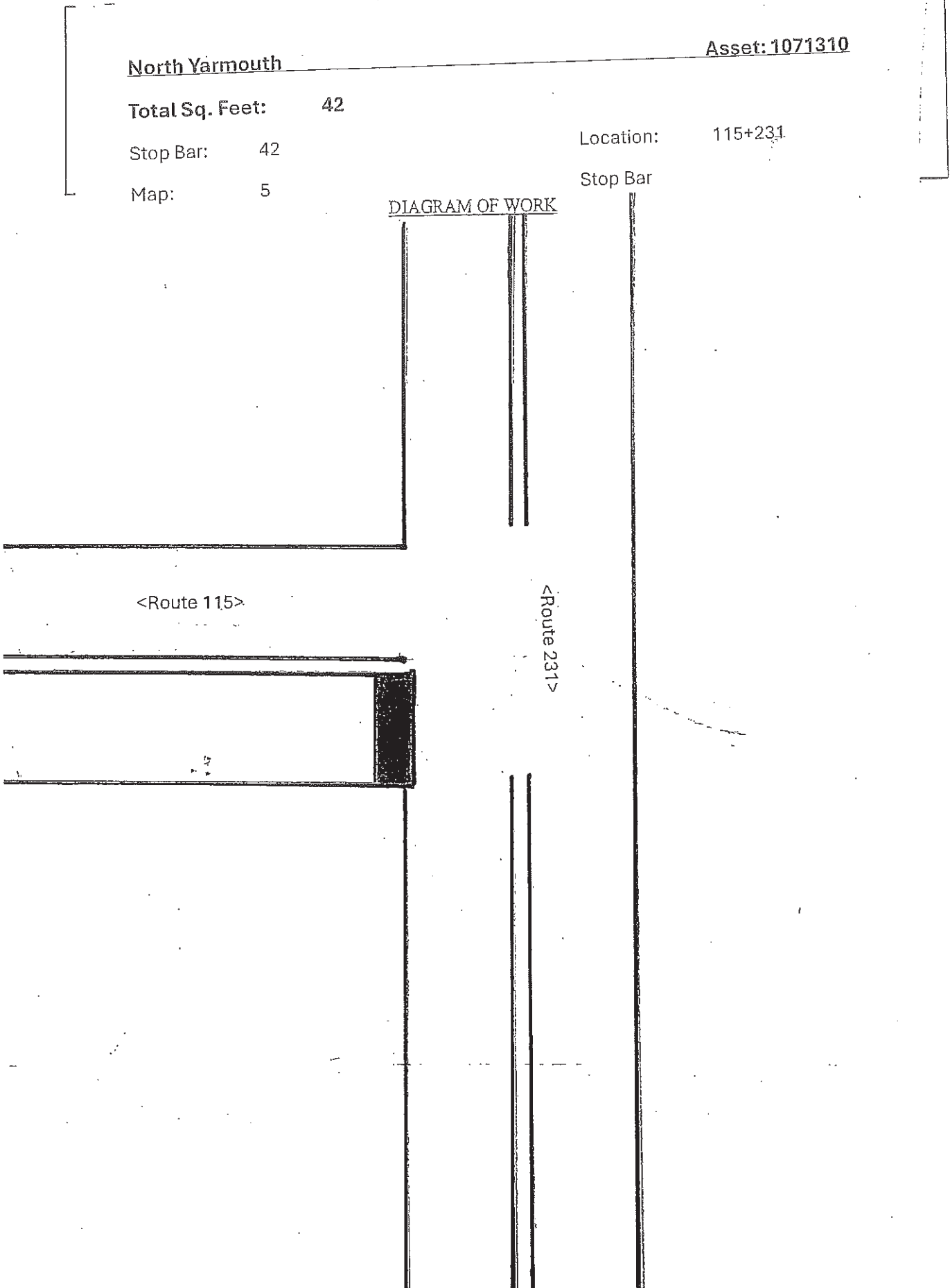

DESCRIPTION OF WORK DONE

Pownal

Asset: 904130

Total Sq. Feet: 375

Stop Bar: 160

Location: Route 9 + Elmwood

Stop AHD: 148

Map: 5

White Curb: 67

4 way Stop Bar/ Stop AHD/ White Curb

DIAGRAM OF WORK

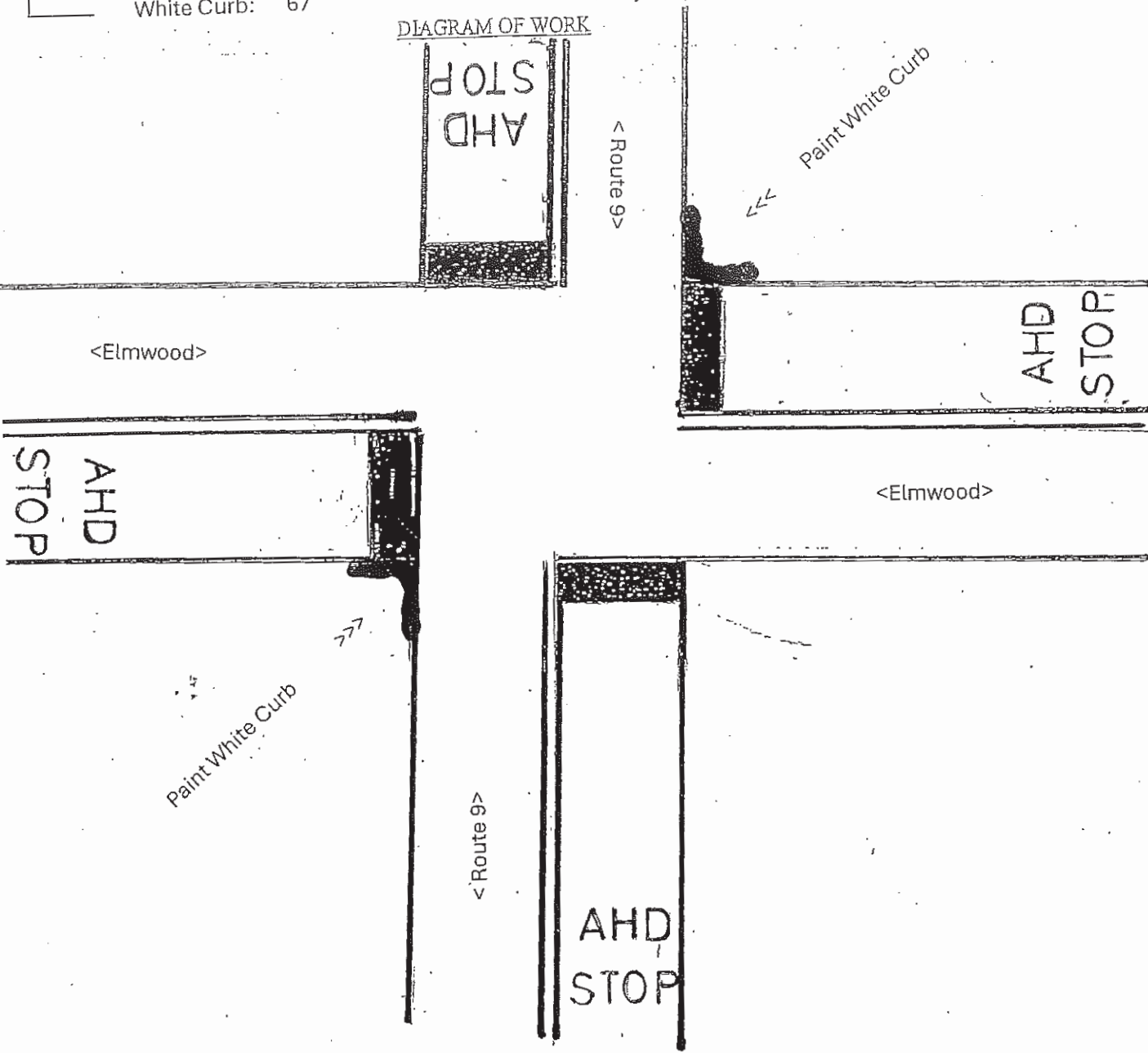

CREW LEADER _____
 YES NO
 PROJECT DONE BEFORE _____
 DATE _____
 ACTUAL JOB TIME _____

DIVISION _____
 TOWN _____
 ROUTE OR _____
 ROAD NO. _____

Railroad Crossing

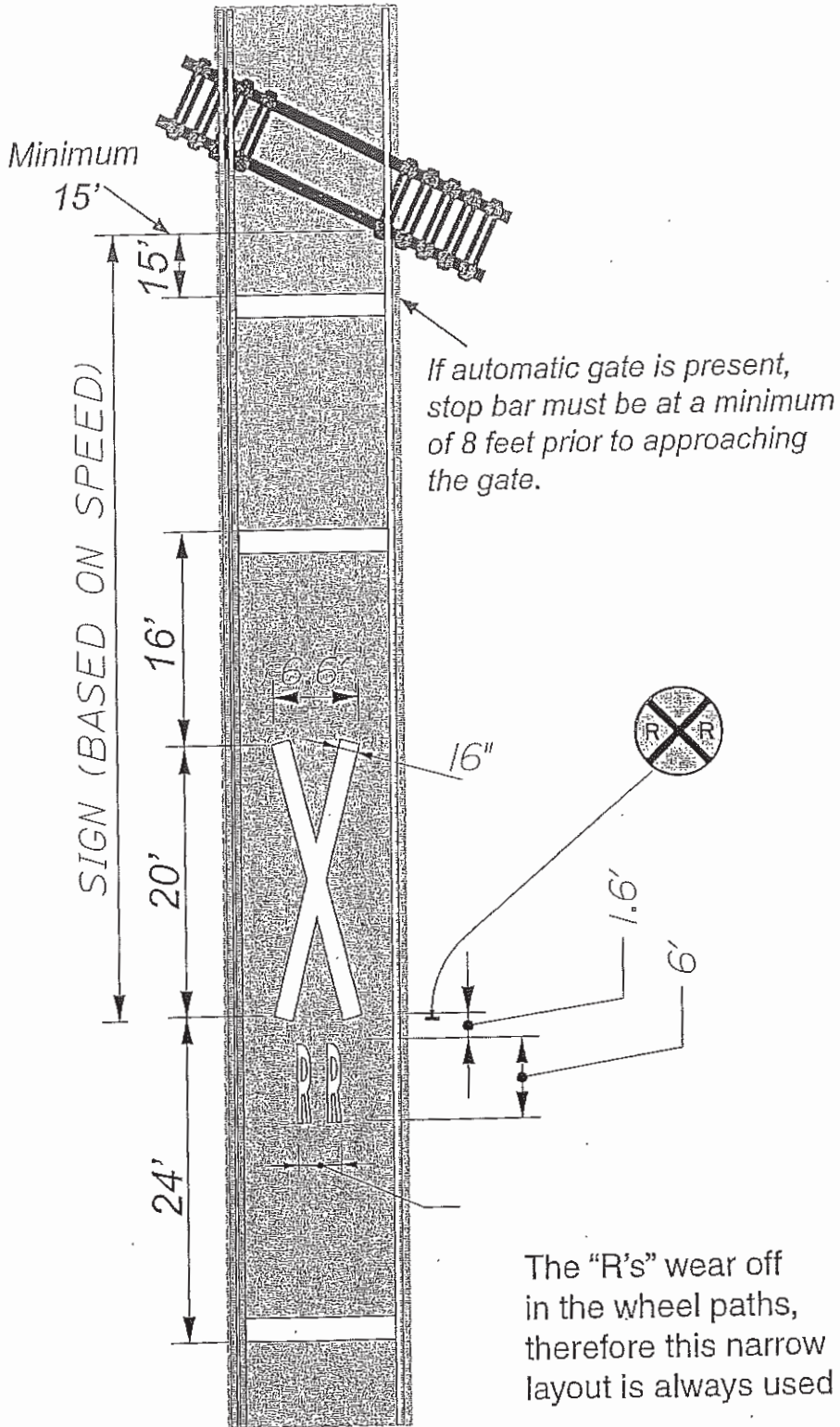

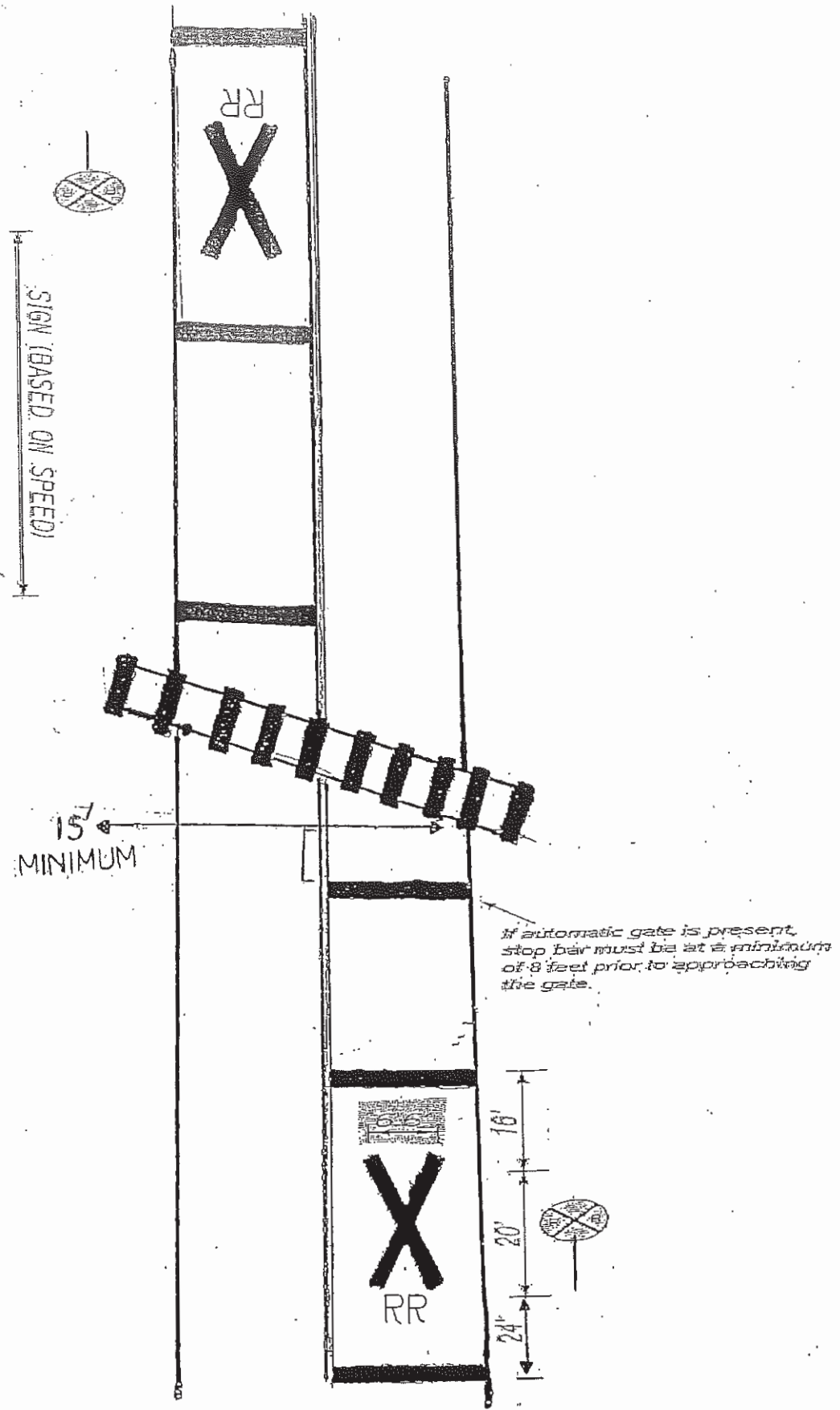

LANE REDUCTION ARROW

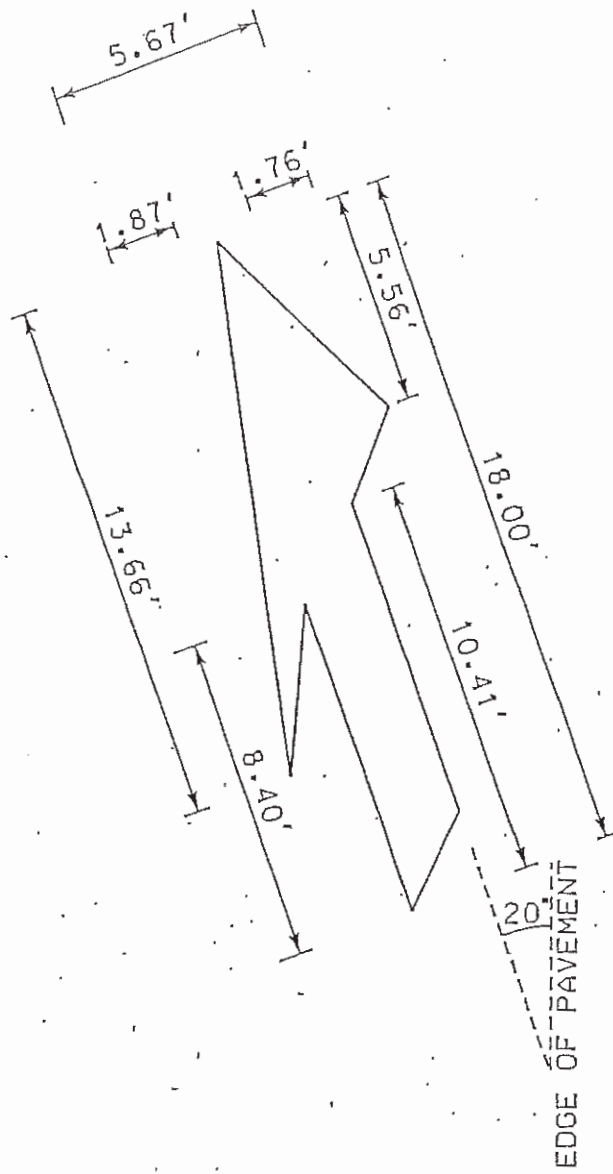

37.90 Square Feet

PROPORTIONATE
NOT TO SCALE

OF 1	SHEET NUMBER	PROJECT	DATE	SCALE	REV.
					1

A – Lane reduction

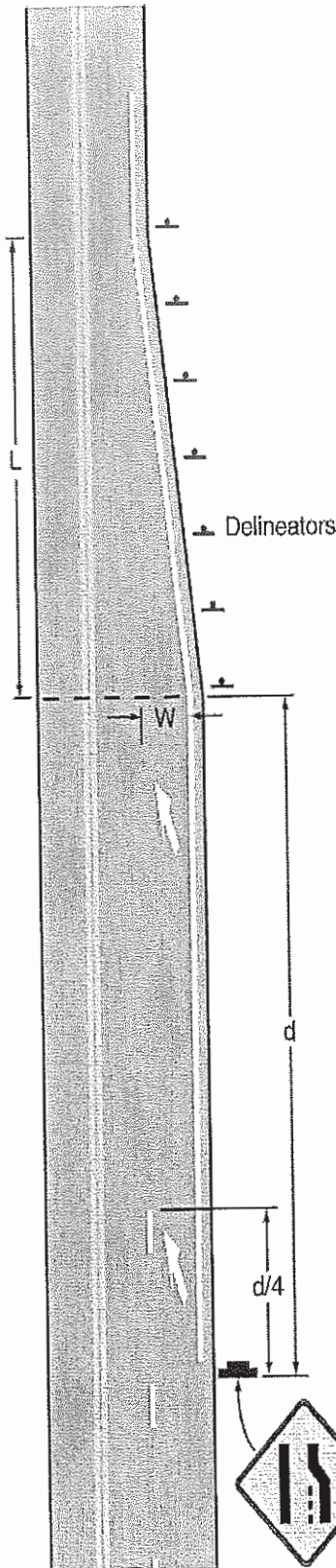

B – Lane reduction with lateral shift to the left

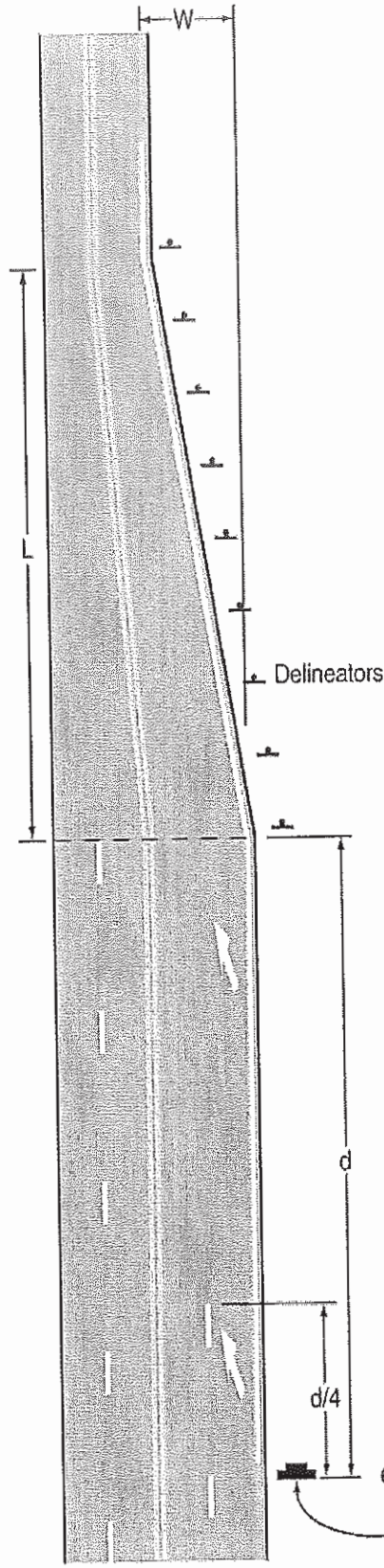

Notes:

1. Lane-reduction arrows are optional for speeds of less than 45 mph
2. See Section 3F.04 for delineator spacing
3. $L = WS$ for speeds of 45 mph or greater and $L = WS^2/60$ for speeds of less than 45 mph, where:
 L = Length of taper in feet
 S = Posted, 85th-percentile, or statutory speed in mph
 W = Offset in feet
4. d = Advance warning distance (see Section 2C.05)

Region 2 Pavement Markings

Town	Asset #	Square Feet	Location	Map#	Type
Albion	904286	391	202 & Benton Rd.	21	Intersection
Augusta	997188	84	3	13	LRA
Augusta	997213	84	3	13	LRA
Augusta	997191	84	3	13	LRA
Belfast	904301	64	3	14	Intersection
Belgrade	904313	170	Castle Island Rd.	12	Intersection
Belgrade	904315	176	8 & 11	20	Intersection
Belgrade	1053955	96	8 + 27	12	Intersection
Belgrade	1053944	124	135 + 8 + 11	12	Intersection
Belgrade	1053953	100	135 + 27	12	Intersection
Belgrade	904718	260	Route 8	12	Rail Road
Belmont	1006145	673	3 & 131	14	Intersection
Benton	904317	100	139 & River Rd.	21	Intersection
Benton	904319	45	139 & Garland Rd.	21	Intersection
Benton	904720	275	River RD	21	Rail Road
Camden	1053967	22	Mechanic St + John St	14	Intersection
Chelsea	1052289	82	226 + 17	13	Intersection
China	904335	651	3 & 32	13	Intersection
China	904337	114	137 & 202	13	Intersection
China/S. China	904339	682	3 & 32	13	Intersection
China/S. China	904341	313	3 & 202	13	Intersection
China/S. China	904343	240	3 & Dirigo &	13	Intersection
China	997200	84	3	13	LRA
Clinton	904620	275	Baker Street	21	Rail Road
Fairfield	999681	84	201	21	LRA
Fairfield	999683	84	201	21	LRA
Fairfield	904367	225	201 & I-95	21	Intersection
Fairfield	928706	95	23 & 201	21	Intersection
Fairfield	953191	349	201 & School	21	Intersection
Fairfield	1053963	72	139+104	21	Intersection
Fairfield	1053961	92	104+139	21	Intersection
Fairfield	904820	275	201	21	Rail Road
Fairfield	1010891	200	23	21	Rail Road
Greene	904808	260	Sawyer Road	12	Rail Road
Hope	904387	325	105 & 235	14	Intersection
Jefferson	904346	282	17 & 32	13	Intersection
Jefferson	904389	101	32+East Pont Rd	13	Intersection
Jefferson	1034356	24	126+32	13	Intersection
Jefferson	998537	88	32+213	13	Intersection
Jefferson	1034358	102	213+126	13	Intersection

Region 2 Pavement Markings

Town	Asset #	Square Feet	Location	Map#	Type
Jefferson	1034360	124	215+126	13	Intersection
Jefferson	1034362	60	215+32	13	Intersection
Leeds	928708	101	202 & 106	12	Intersection
Leeds	904858	260	Bishop	12	Rail Road
Leeds	904860	260	Androscoggin St.	12	Rail Road
Leeds	904862	260	North Leeds	12	Rail Road
Leeds	904864	260	North Leeds	12	Rail Road
Lincolnton	904393	236	52 & 173	14	Intersection
Lincolnton	1053639	54	52		Intersection
Lincolnton	1080696	20	235+173		Intersection
Monmouth	904457	219	132 & 202	12	Intersection
Monmouth	1081288	24	135+132	12	Intersection
Monmouth	904866	260	Main St.	12	Rail Road
Mt. Vernon	904461	182	41 & North Rd.	12	Intersection
Palermo	997194	84	3	13	LRA
Palermo	997198	84	3	13	LRA
Palermo	997196	84	3	13	LRA
Readfield	904500	119	17 & North Rd	12	Intersection
Readfield	904503	188	17 & 41	12	Intersection
Readfield	904505	107	17 & 41	12	Intersection
Readfield	1080424	60	135+17	12	Intersection
Readfield	1080422	78	135+17	12	Intersection
Readfield	904883	260	Main street	12	Rail Road
Rockport	904560	361	US1 & 90	14	Intersection
Rockport	904562	208	90	14	Intersection
Rockport	904666	692	17 & 90	14	Intersection
Rome	1053957	80	225+27	20	Intersection
Searsmont	904566	103	3 & New England	14	Intersection
Searsmont	904564	83	173 & Howard Rd.	14	Intersection
Searsmont	997548	84	3	14	LRA
Searsmont	997550	84	3	14	LRA
Smithfield	1053959	40	225+8+137	20	Intersection
Troy	1080833	44	202+220	22	Intersection
Union	904582	95	17 & 131	14	Intersection
Union	1005965	87	17+234	14	Intersection
Union	1053867	96	235+17	14	Intersection
Union	1053869	50	131+17	14	Intersection
Unity	1080823	28	139+202	22	Intersection
Unity	1080825	88	139+202	22	Intersection
Unity	1080827	40	220+202	22	Intersection
Unity	1080829	52	139+220	22	Intersection

Region 2 Pavement Markings

Town	Asset #	Square Feet	Location	Map#	Type
Unity	1080831	54	139+220	22	Intersection
Wales	904897	260	Leeds Jct. Road	12	Rail Road
Washington	1034354	62	126+220	13	Intersection
Washington	1052295	26	206 + 17	13	Intersection
Washington	1052297	44	105 + 206	13	Intersection
Washington	1052299	86	105 + 220	13	Intersection
Washington	1052301	120	220 + 17	13	Intersection
Warren	904595	145	US1 & 90	14	Intersection
Warren	904597	956	131 & 90	14	Intersection
Wayne	904601	97	219 & 133	12	Intersection
Whitefield	1052291	38	218 + 17	13	Intersection
Whitefield	1052293	78	218 + 126	13	Intersection
Windsor	904608	302	17 & 32	13	Intersection
Windsor	904605	127	105 & 32	13	Intersection
Winthrop	904635	180	133 & High School	12	Intersection
Winthrop	904907	200	Main St.	12	Rail Road
Total Sq feet		15678			

904286

PAVEMENT MARKINGS

Project No. _____

904286

DESCRIPTION OF WORK DONE

STRAIGHT ARROW _____	LANE LINE _____
TURN ARROW _____	STOP _____
STOP BAR _____ 106	ONLY _____
CURBING-YELLOW _____ 60	STOP AHEAD _____
WHITE _____ 225	CROSSWALKS _____
HASH MARKS _____	TOTAL SQ. FT. _____ 391
MISC. _____	

DIAGRAM OF WORK

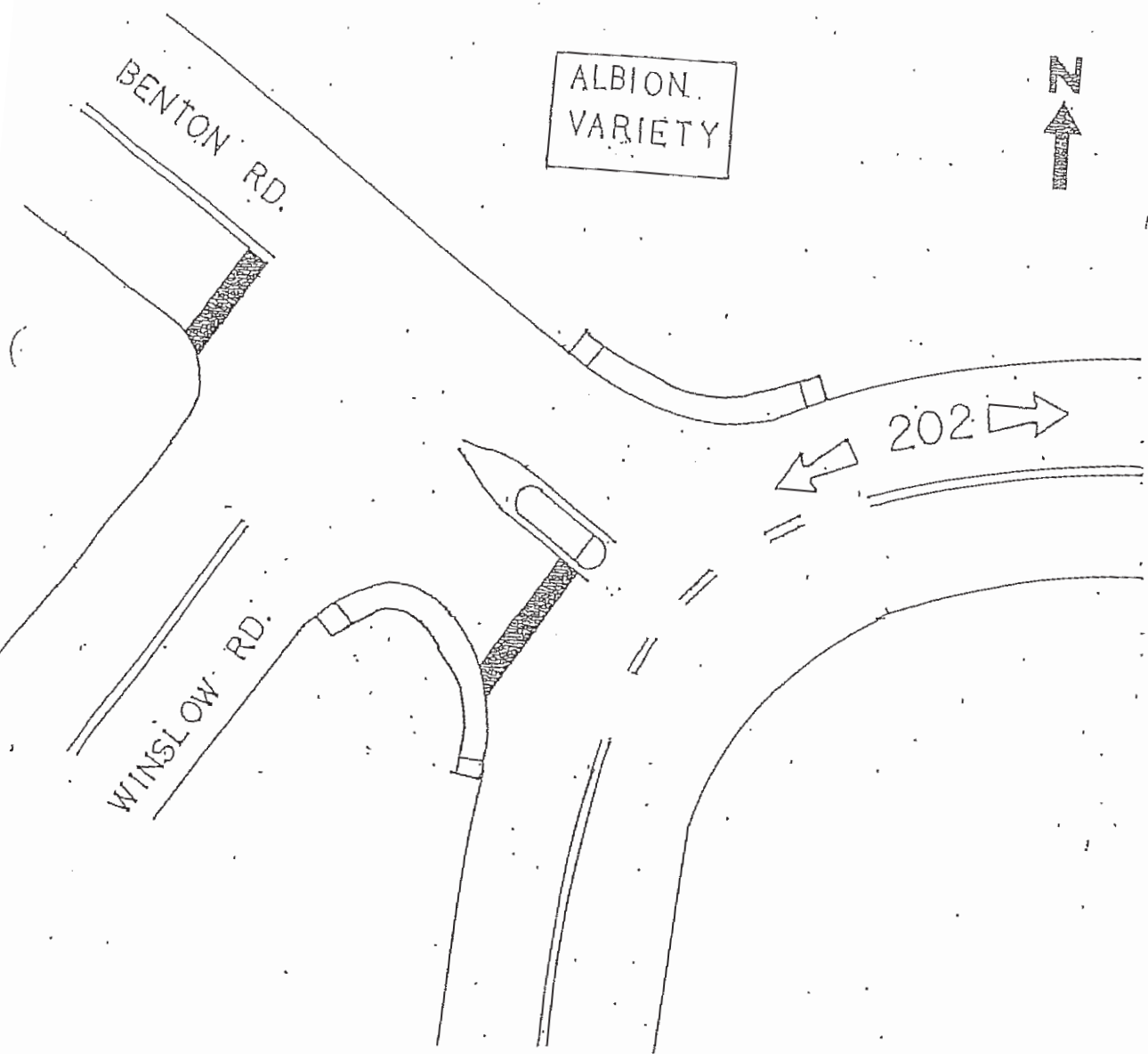

CREW LEADER _____ YES NO

PROJECT DONE BEFORE _____ DATE _____

DIVISION _____

TOWN ALBION
ROUTE OR 202 & BENTON RD.
ROAD NO.

904301

PAVEMENT MARKINGS

Project No. _____

904301

DESCRIPTION OF WORK DONE

STRAIGHT ARROW _____	LANE LINE _____
TURN ARROW _____ 64 _____	STOP _____
STOP BAR _____	ONLY _____
CURBING-YELLOW _____	STOP AHEAD _____
WHITE _____	CROSSWALKS _____
HASH MARKS _____	TOTAL SQ. FT. _____ 64 _____
MISC. _____	

DIAGRAM OF WORK

BELFAST
SELF
STORAGE

SWEETSTER



CREW LEADER _____
 YES NO
 PROJECT DONE BEFORE _____

DIVISION _____
 TOWN. BELFAST
 ROUTE OR 3
 ROAD NO. _____

PAVEMENT MARKINGS

Project No. _____

904313

DESCRIPTION OF WORK DONE

STRAIGHT ARROW _____	LANE LINE _____
TURN ARROW _____	STOP 44 _____
STOP BAR 48 _____	ONLY _____
CURBING-YELLOW _____	STOP AHEAD 78 _____
WHITE _____	CROSSWALKS _____
HASH MARKS _____	TOTAL SQ. FT. 170 _____
MISC. _____	

DIAGRAM OF WORK

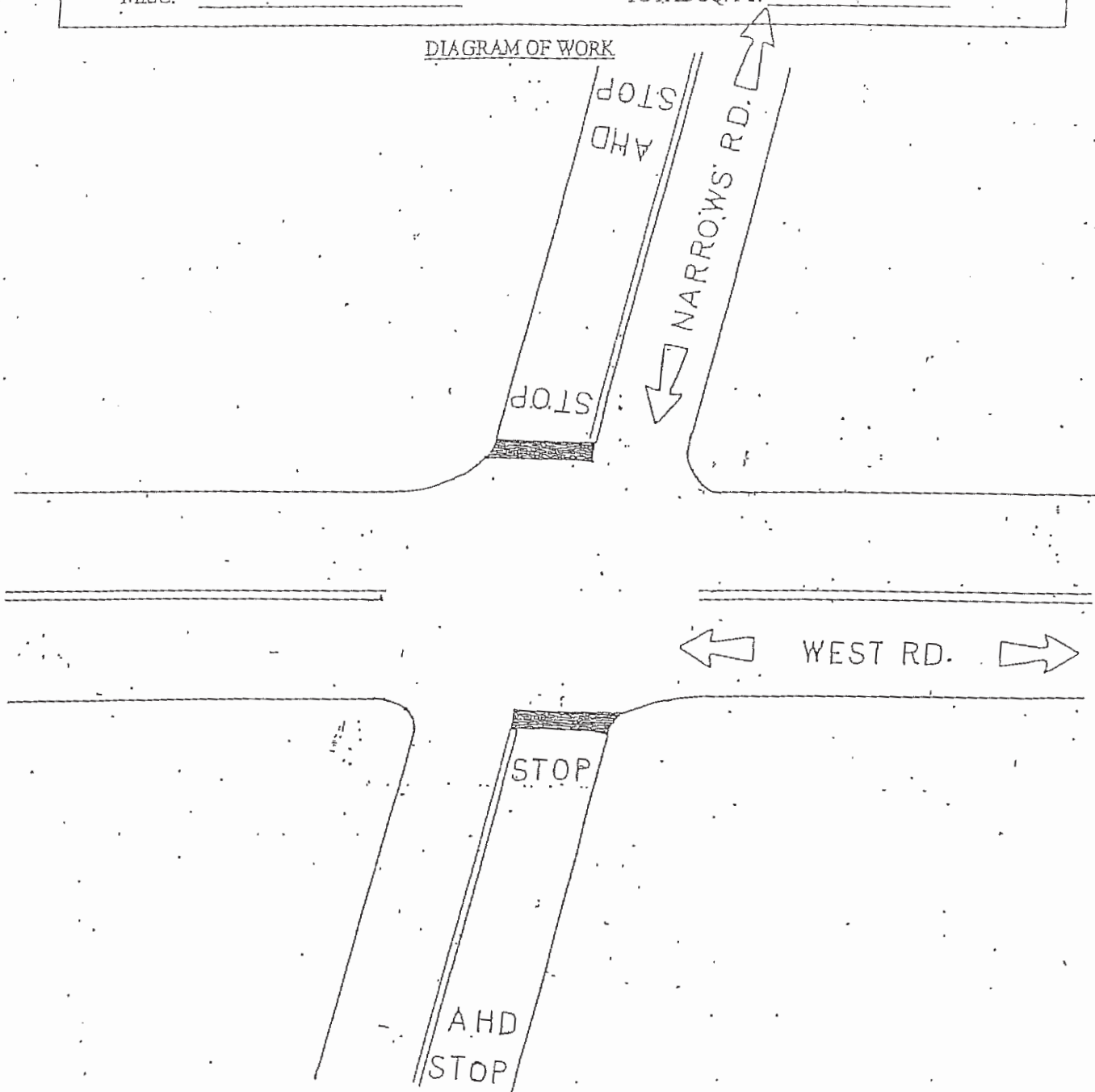

CREW LEADER _____ YES NO

PROJECT DONE BEFORE _____

DATE _____

ACTUAL JOB TIME _____

REGION 2 _____

TOWN BELGRADE

ROUTE OR CASTLE ISLAND

ROAD NO.

PAVEMENT MARKINGS

Project No. 904315

DESCRIPTION OF WORK DONE

STRAIGHT ARROW _____	LANE LINE _____
TURN ARROW _____	STOP _____ <u>22</u>
STOP BAR _____ <u>65</u>	ONLY _____
CURBING-YELLOW _____ <u>50</u>	STOP AHEAD _____ <u>39</u>
WHITE _____	CROSSWALKS _____
HASH MARKS _____	TOTAL SQ. FT. _____ <u>176</u>
MISC. _____	

DIAGRAM OF WORK

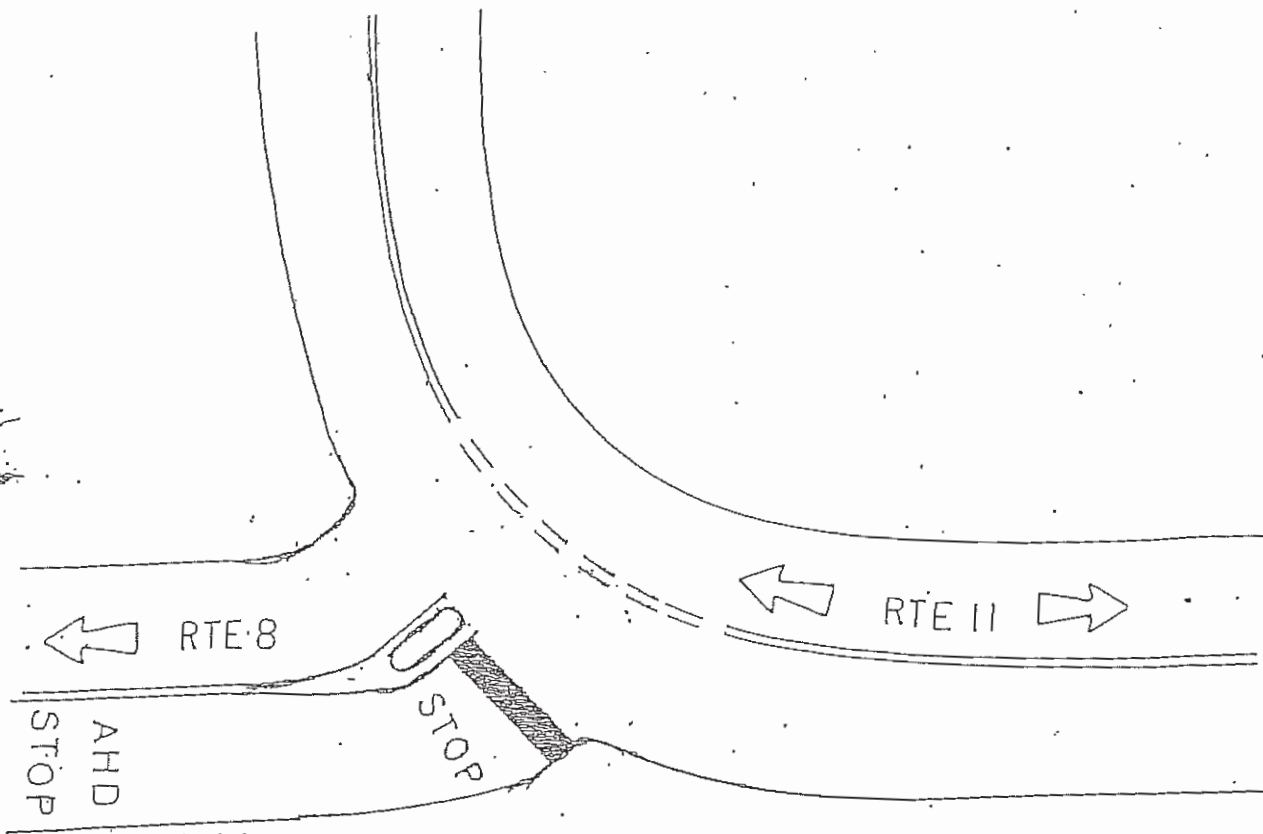

CREW LEADER _____
 YES NO
 PROJECT DONE BEFORE _____
 DATE _____
 COST PER HOUR _____

REGION 2

TOWN BELGRADE
 ROUTE OR 8 & 11
 ROAD NO. _____

PAVEMENT MARKINGS

Project No. _____

DESCRIPTION OF WORK DONE

Belgrade	Asset: 1053955
Total Sq. Feet: 96	
Stop Bar: 96	Location: Route 27 + 8+11

DIAGRAM OF WORK

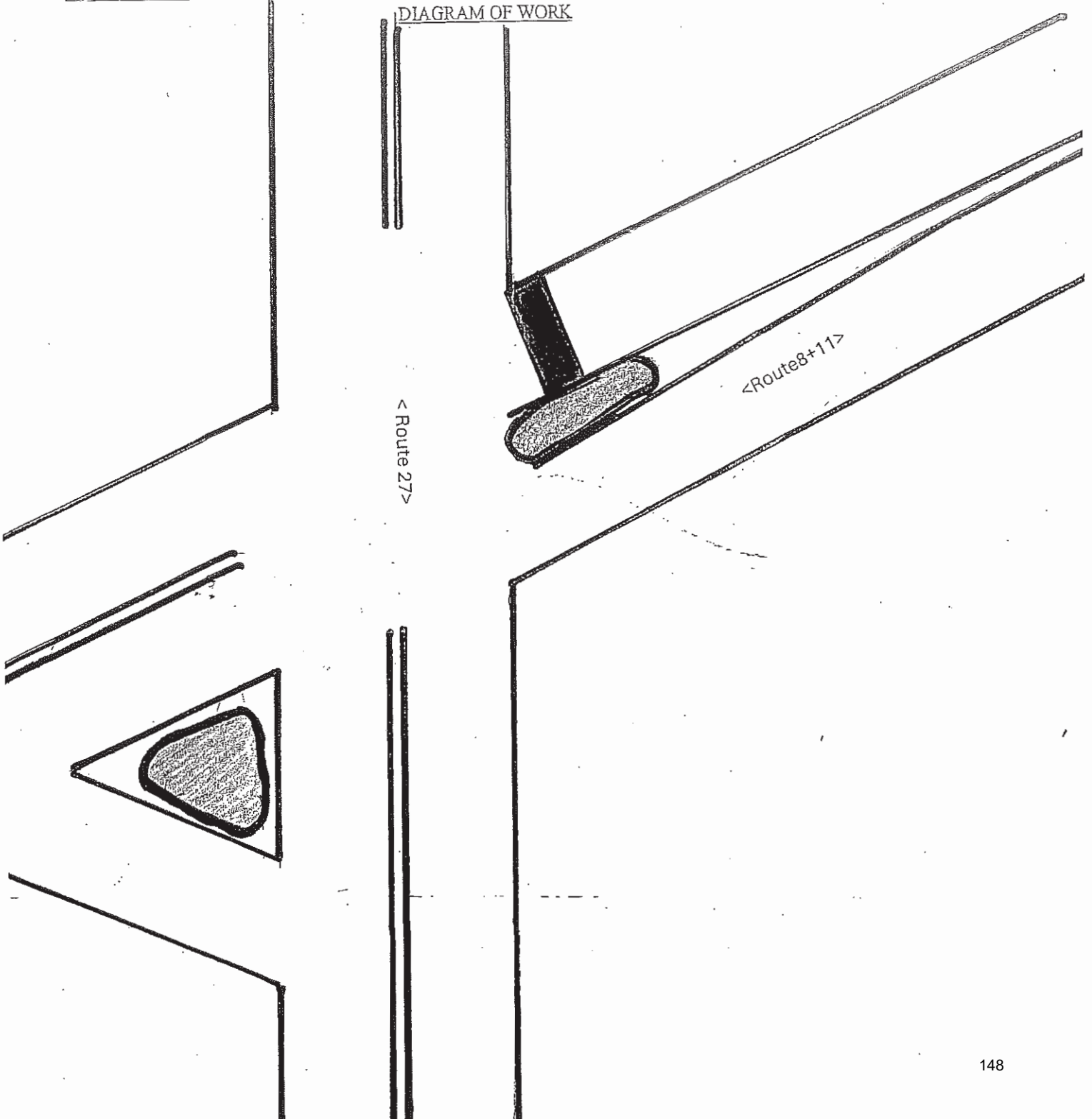

PAVEMENT MARKINGS

Project No.

DESCRIPTION OF WORK DONE

<u>Belgrade</u>		<u>Asset: 1053944</u>	
Total Sq. Feet:	124	Location:	Route 135 + 8+11
Stop Bar:	124	Next to Cemetery and MDOT Lot	

DIAGRAM OF WORK

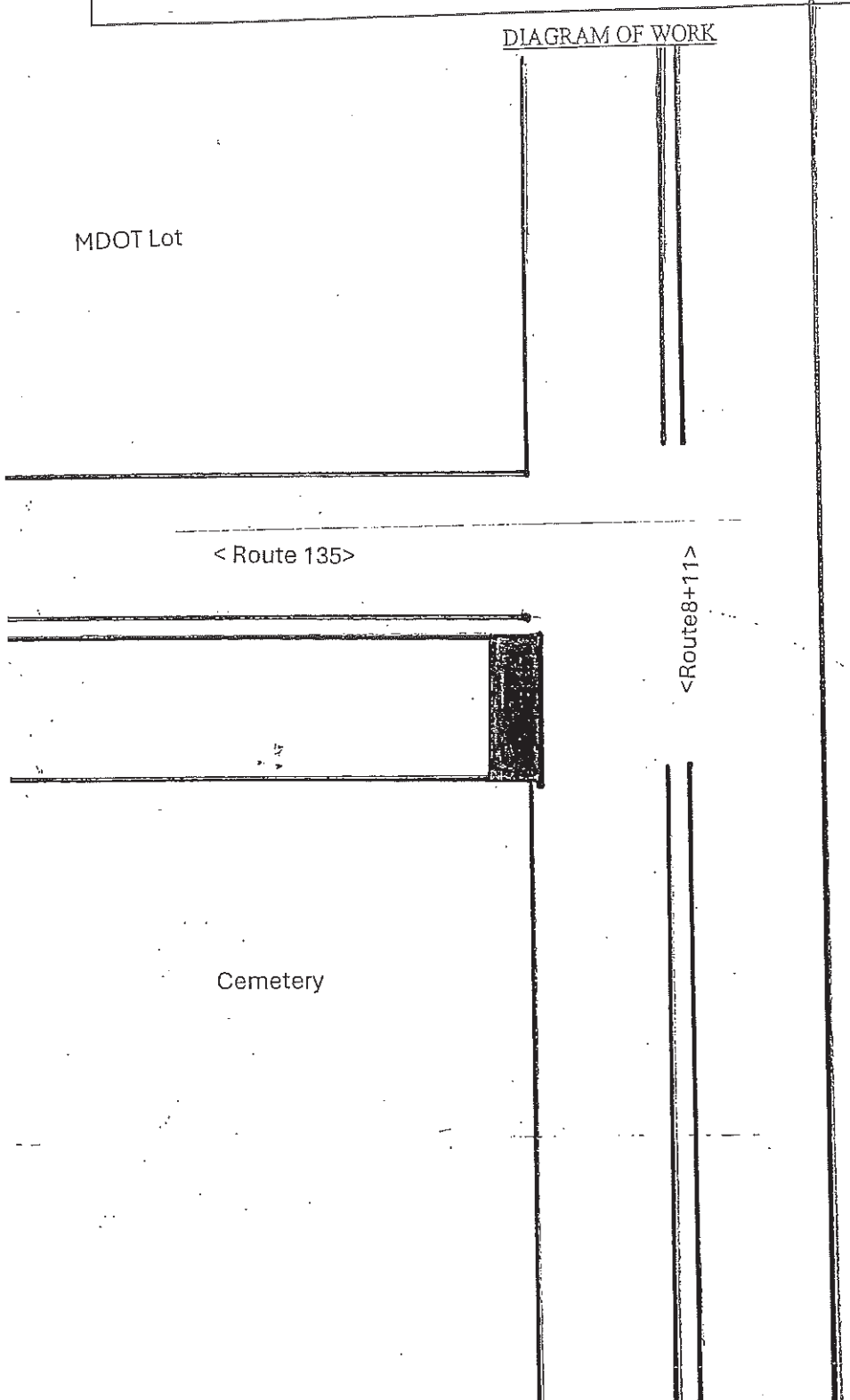

DESCRIPTION OF WORK DONE

Belgrade		Asset: 1053953	
Total Sq. Feet:	100	Location:	Route 135 +27
Stop Bar:	100	Stop Bars on Both sides of Route 135	

DIAGRAM OF WORK

Christy's Country Store

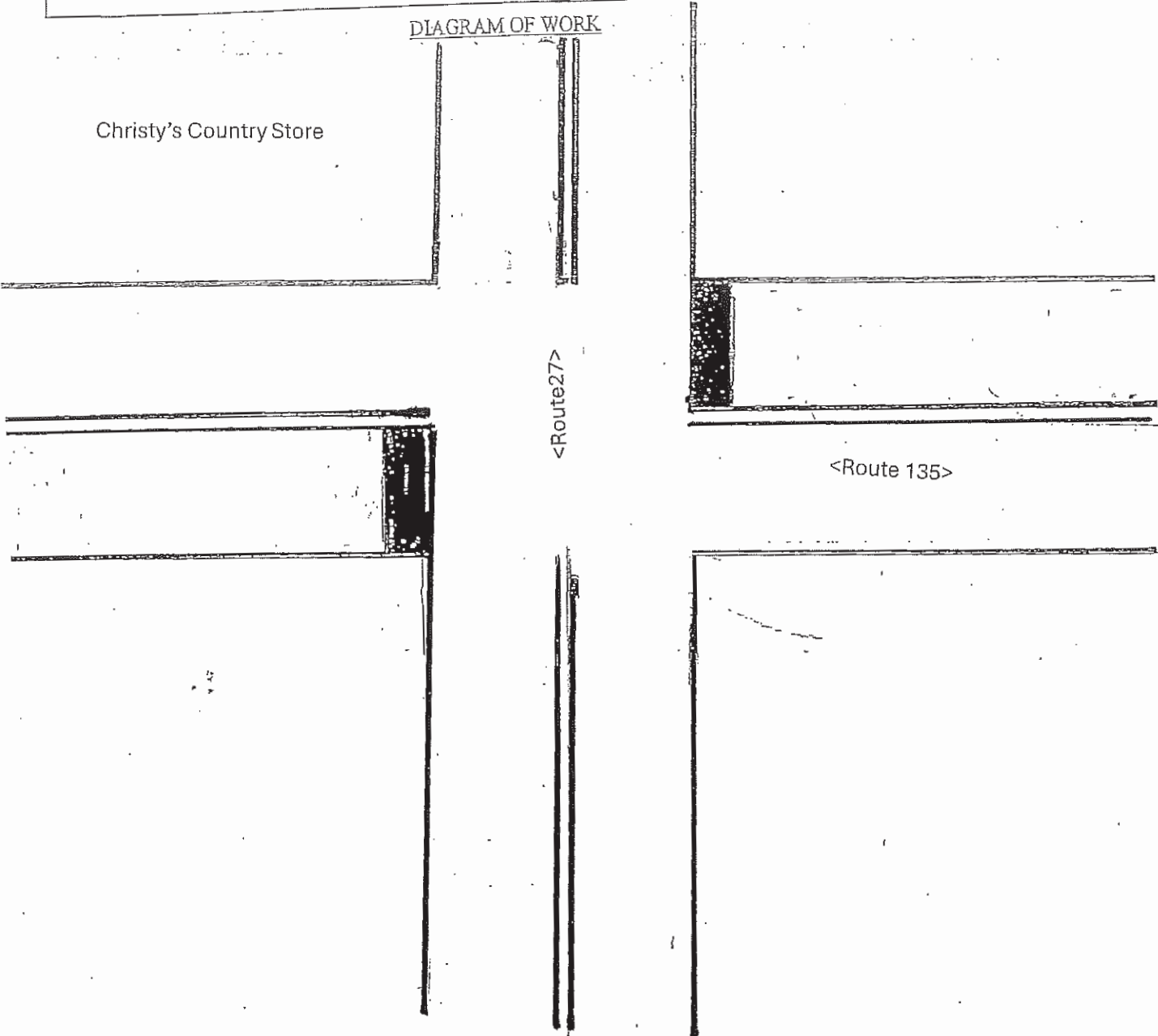

CREW LEADER _____
 YES NO
 PROJECT DONE BEFORE _____
 DATE _____
 ACTUAL JOB TIME _____

DIVISION _____
 TOWN _____
 ROUTE OR _____
 ROAD NO. _____

STRAIGHT ARROW		LANE LINE	
TURN ARROW	96	STOP	
STOP BAR	110	ONLY	
CURBING-YELLOW		STOP AHEAD	117
WHITE		CROSSWALKS	
HASH MARKS	350	TOTAL SQ. FT.	673
MISC.			

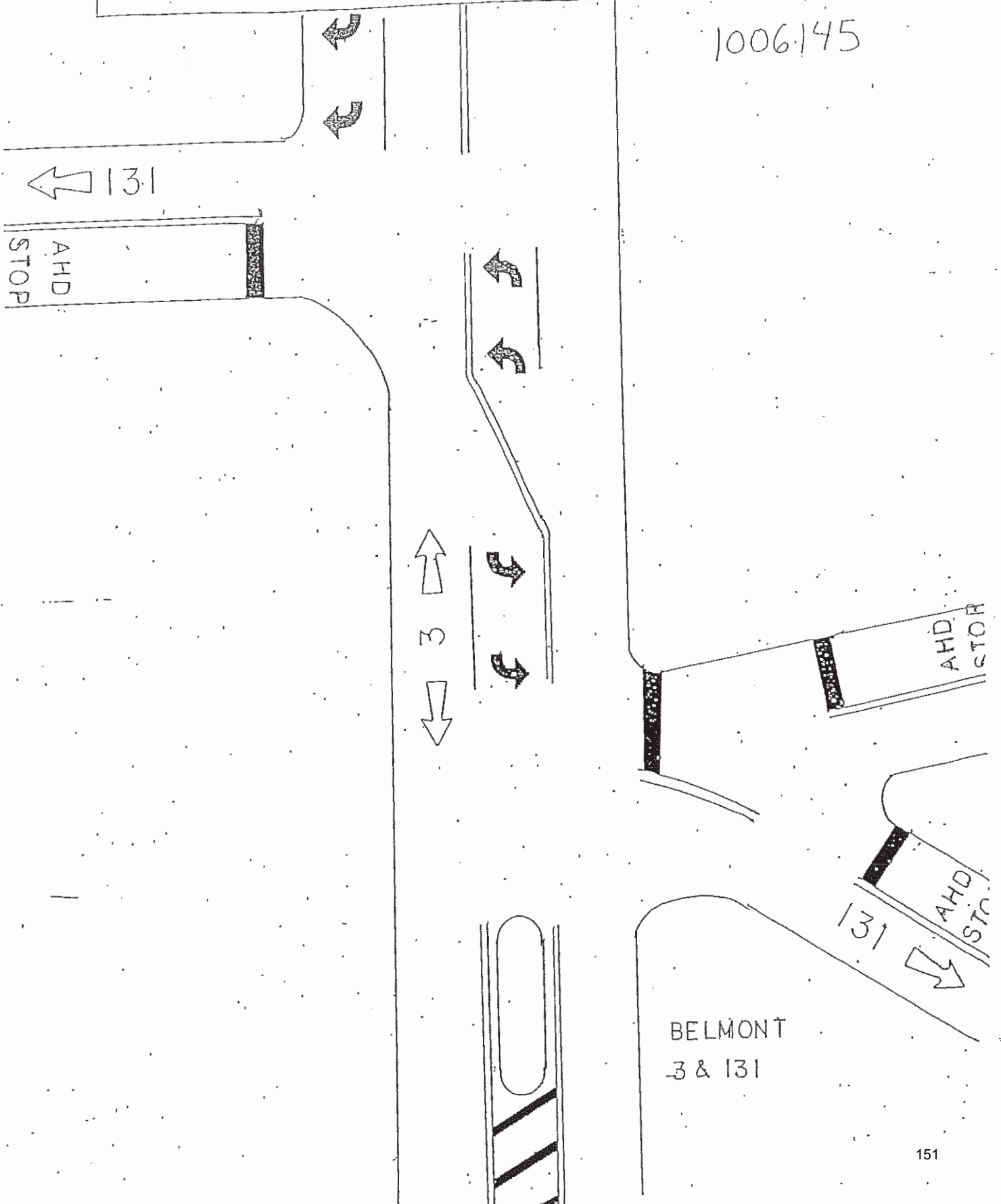

904317

PAVEMENT MARKINGS

Project No.

904317

DESCRIPTION OF WORK DONE

STRAIGHT ARROW _____	LANE LINE _____
TURN ARROW _____	STOP _____
STOP BAR _____ 100 _____	ONLY _____
CURBING-YELLOW _____	STOP AHEAD _____
WHITE _____	CROSSWALKS _____
HASH MARKS _____	TOTAL SQ. FT. 100 _____
MISC. _____	

DIAGRAM OF WORK

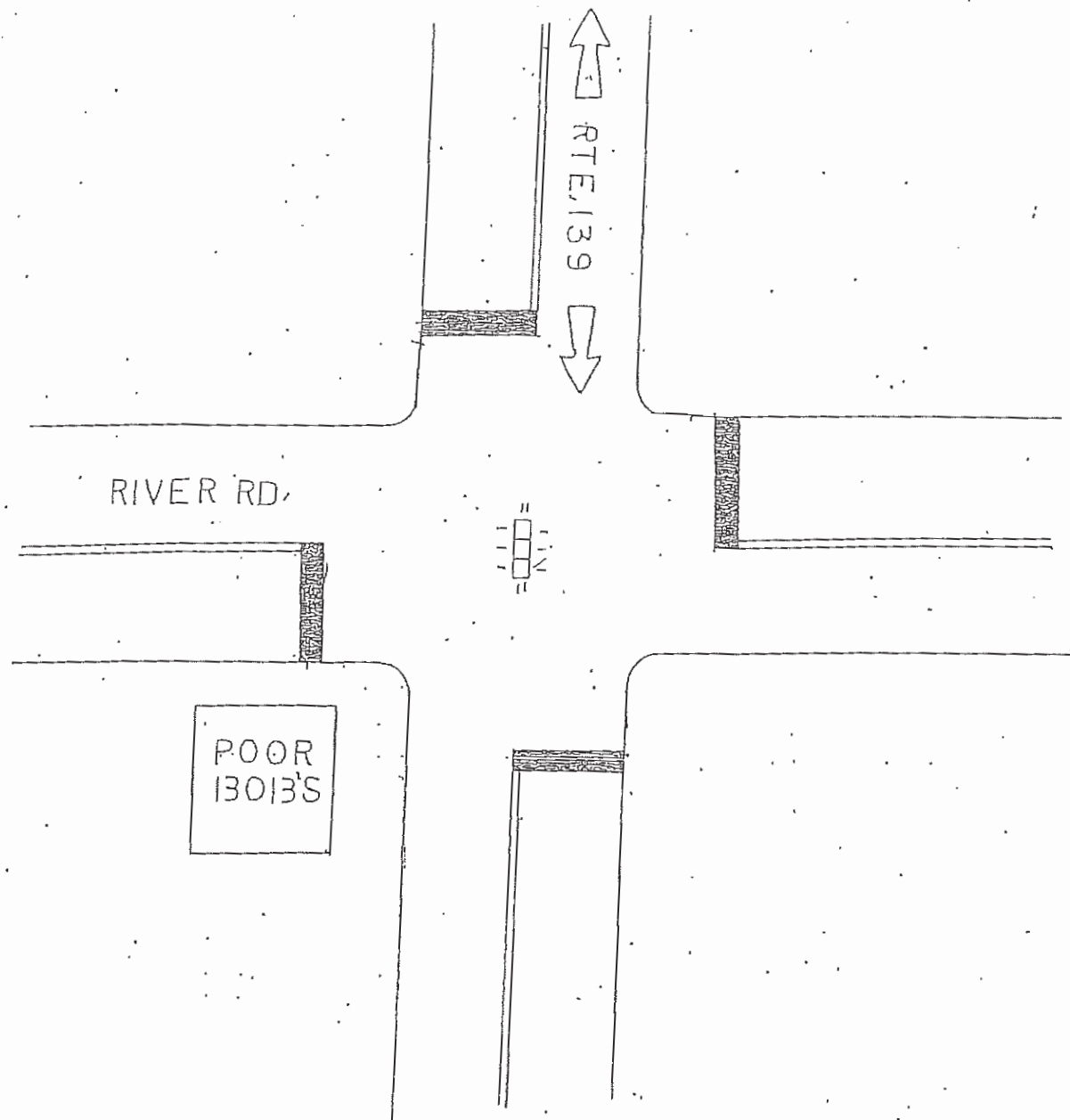

CREW LEADER _____ YES NO

PROJECT DONE BEFORE _____

REGION 2

TOWN- BENTON
ROUTE OR 139 & RIVER RD.

904319

PAVEMENT MARKINGS

Project No.

904319

DESCRIPTION OF WORK DONE

STRAIGHT ARROW _____	LANE LINE _____
TURN ARROW _____	STOP _____
STOP BAR _____ 45 _____	ONLY _____
CURBING-YELLOW _____	STOP AHEAD _____
WHITE _____	CROSSWALKS _____
HASH MARKS _____	
MISC. _____	TOTAL SQ. FT. _____ 45 _____

DIAGRAM OF WORK

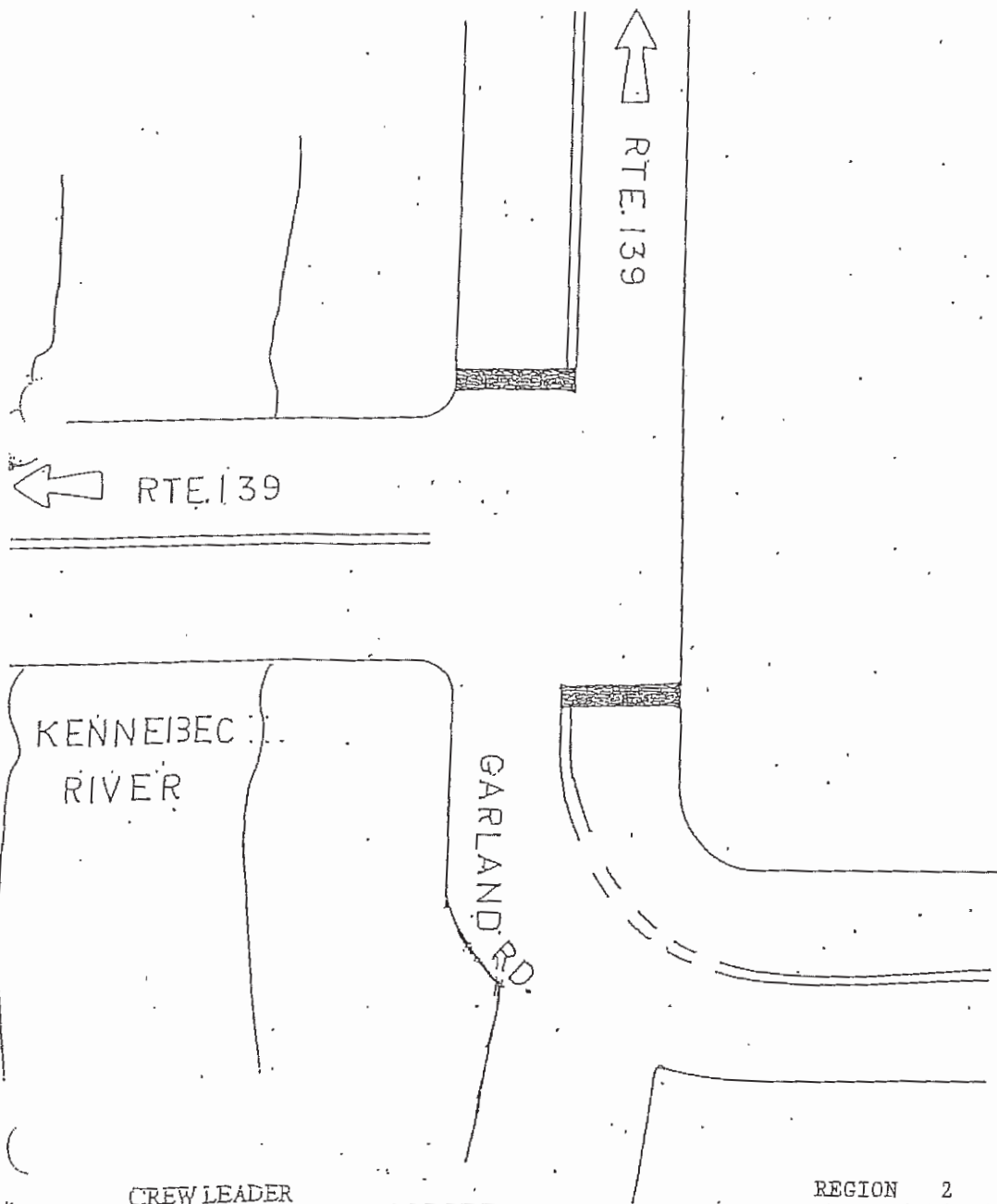

CREW LEADER _____ YES NO

REGION 2 _____

PROJECT DONE BEFORE _____
DATE _____

TOWN BENTON
ROUTE OR 139 & GARLAND RD.
ROAD NO _____

PAVEMENT MARKINGS

Project No.

DESCRIPTION OF WORK DONE

Camden

Asset:1053967

Total Sq. Feet: 22

Mechanic St. and John St.

Stop Bar: 22

DIAGRAM OF WORK

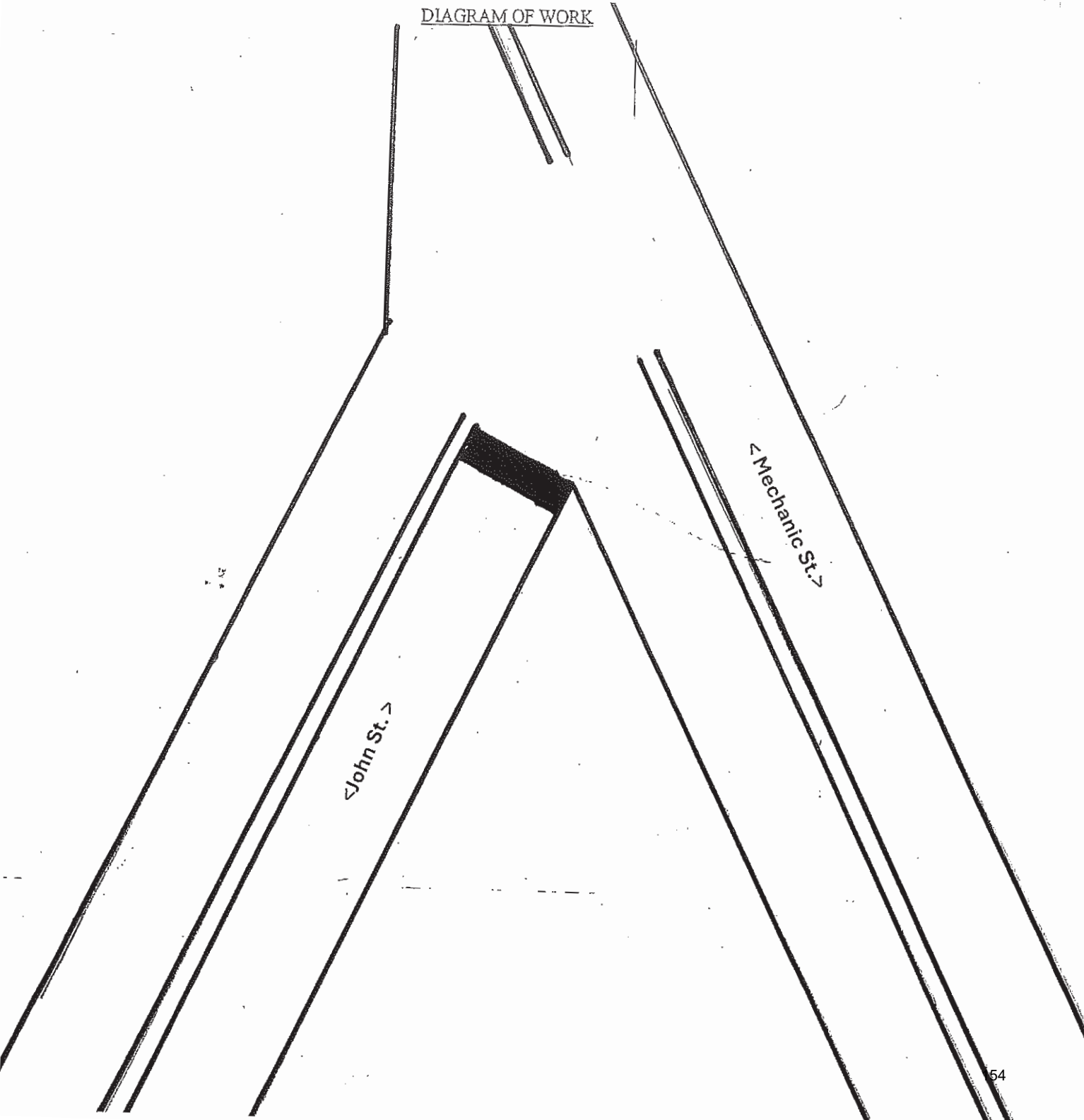

PAVEMENT MARKINGS

Project No. _____

DESCRIPTION OF WORK DONE

<u>Chelsea</u>		Asset:1052289
Total Sq. Feet:	82	Route 226 and Route 17
Stop Bar:	82	

DIAGRAM OF WORK

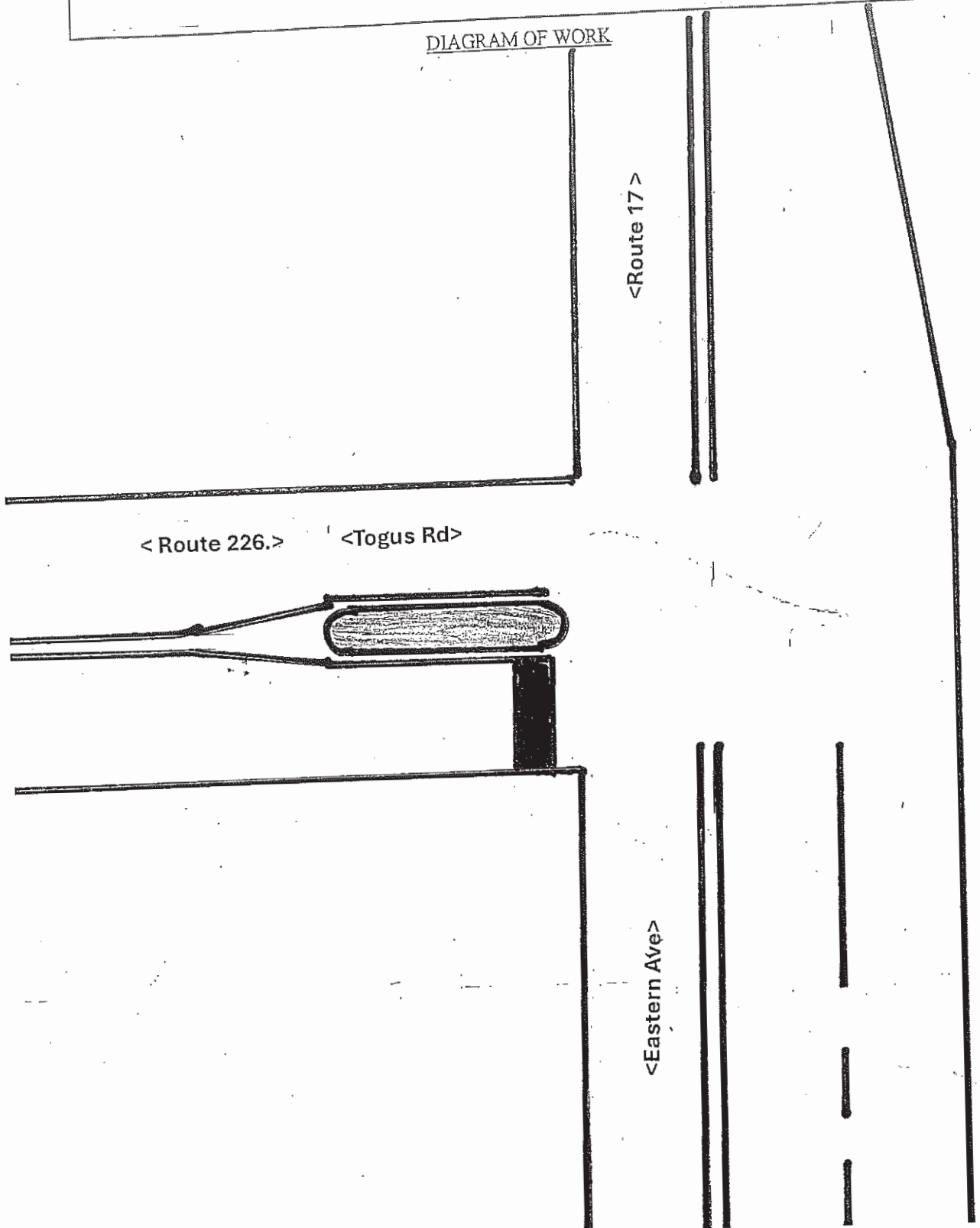

904335

PAVEMENT MARKINGS

Project No. _____

904335

DESCRIPTION OF WORK DONE

STRAIGHT ARROW _____	LANE LINE _____
TURN ARROW _____ 32	STOP _____
STOP BAR _____ 116	ONLY _____
CURBING-YELLOW _____	STOP AHEAD _____ 37
WHITE _____	CROSSWALKS _____
HASH MARKS _____ 466	TOTAL SQ. FT. 651
MISC. _____	

DIAGRAM OF WORK

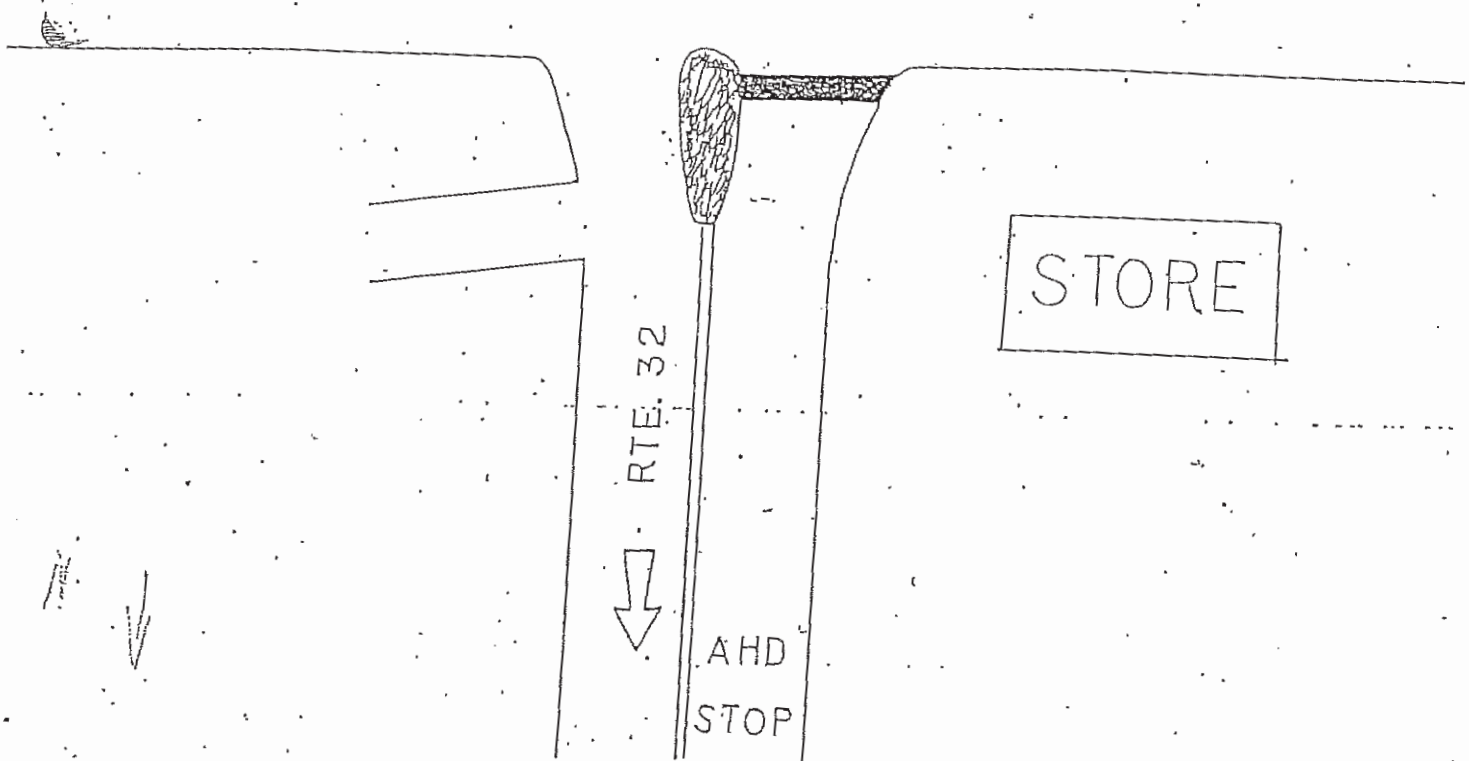
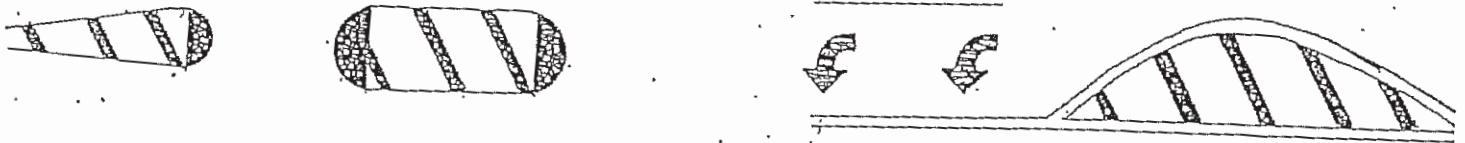

CREW LEADER _____

YES NO

PROJECT DONE BEFORE _____

REGION 2 _____

TOWN CHINA _____

ROUTE OR 3 & 32 _____

ROAD NO _____

PAVEMENT MARKINGS

Project No. _____

904337

DESCRIPTION OF WORK DONE

STRAIGHT ARROW _____	LANE LINE _____
TURN ARROW _____	STOP _____
STOP BAR <u>65</u> _____	ONLY _____
CURBING-YELLOW <u>10</u> _____	STOP AHEAD <u>39</u> _____
WHITE _____	CROSSWALKS _____
HASH MARKS _____	TOTAL SQ. FT. <u>114</u> _____
MISC. _____	

DIAGRAM OF WORK

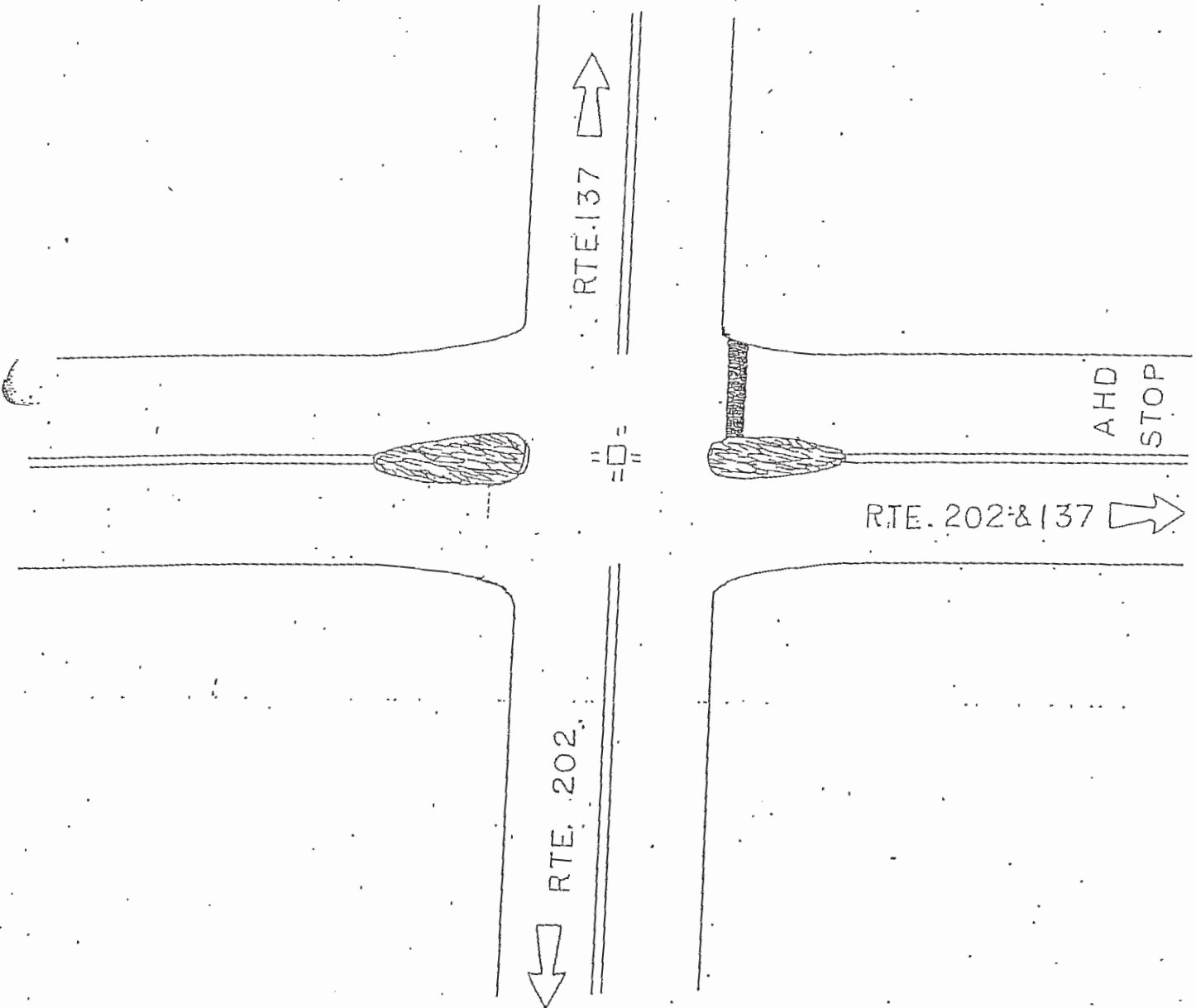

CREW LEADER _____
PROJECT DONE BEFORE _____ YES NO
DATE _____
TIME FOR TIME _____

REGION 2
TOWN CHINA
ROUTE OR 137 & 202
ROAD NO. _____

PAVEMENT MARKINGS

Project No. 904339

904339

DESCRIPTION OF WORK DONE

STRAIGHT ARROW	78	LANE LINE	
TURN ARROW	256	STOP ONLY	
STOP BAR	204	STOP AHEAD	
CURBING-YELLOW		CROSSWALKS	
WHITE		TOTAL SQ. FT.	682
HASH MARKS			
MISC. COMBOS.	124		

DIAGRAM OF WORK

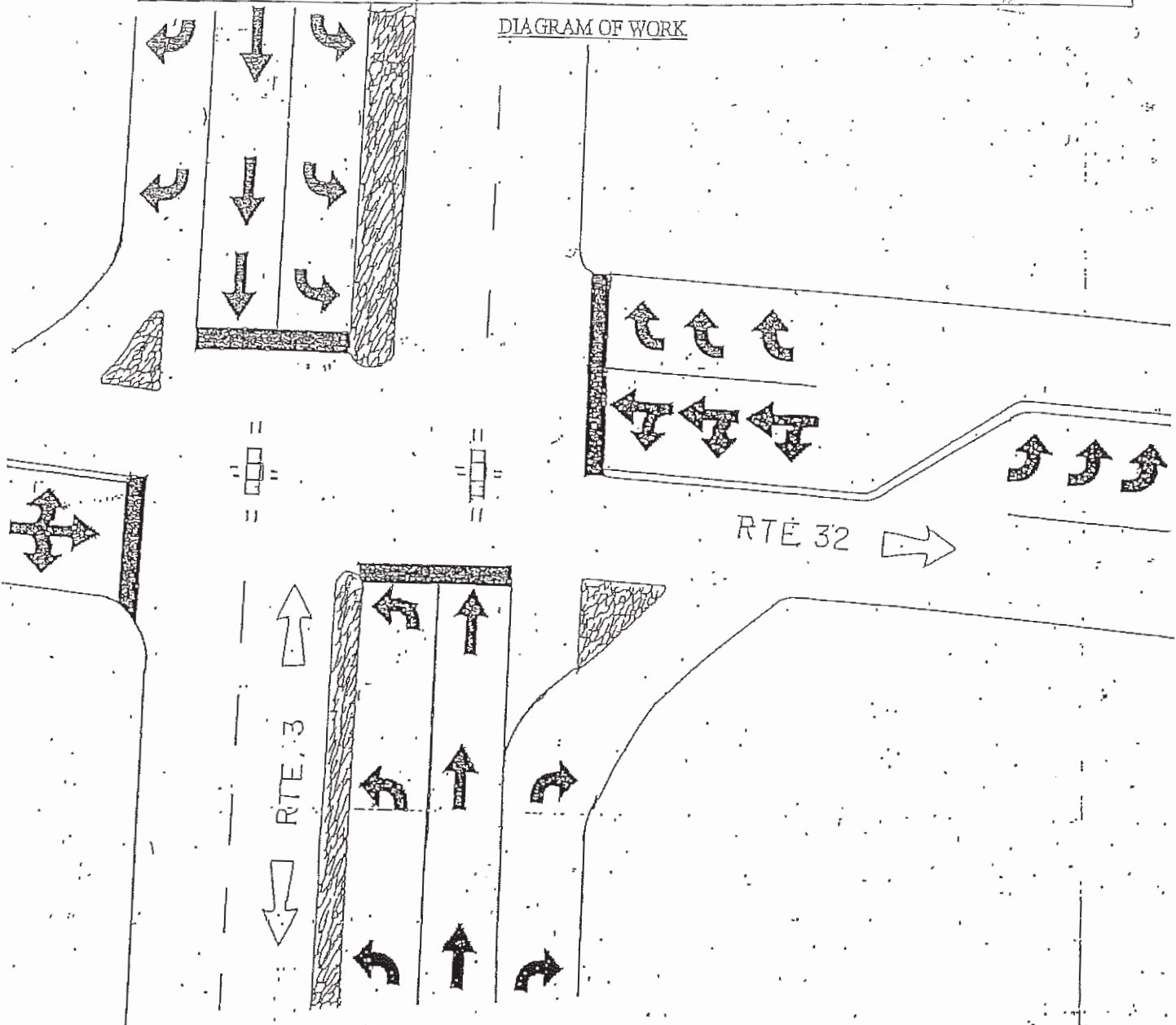

CREW LEADER _____

DIVISION _____

YES NO

PROJECT DONE BEFORE _____

TOWN CHINA / SO. CHINA

DATE _____

ROUTE OR 3 & 32

ACTUAL JOB TIME _____

ROAD NO. _____

PAVEMENT MARKINGS

Project No. 904341

904341

DESCRIPTION OF WORK DONE

STRAIGHT ARROW _____ 117
 TURN ARROW _____ 96
 STOP BAR _____ 100
 CURBING-YELLOW _____
 WHITE _____
 HASH MARKS _____
 MISC. _____

LANE LINE _____
 STOP _____
 ONLY _____
 STOP AHEAD _____
 CROSSWALKS _____
 TOTAL SQ. FT. 313

DIAGRAM OF WORK

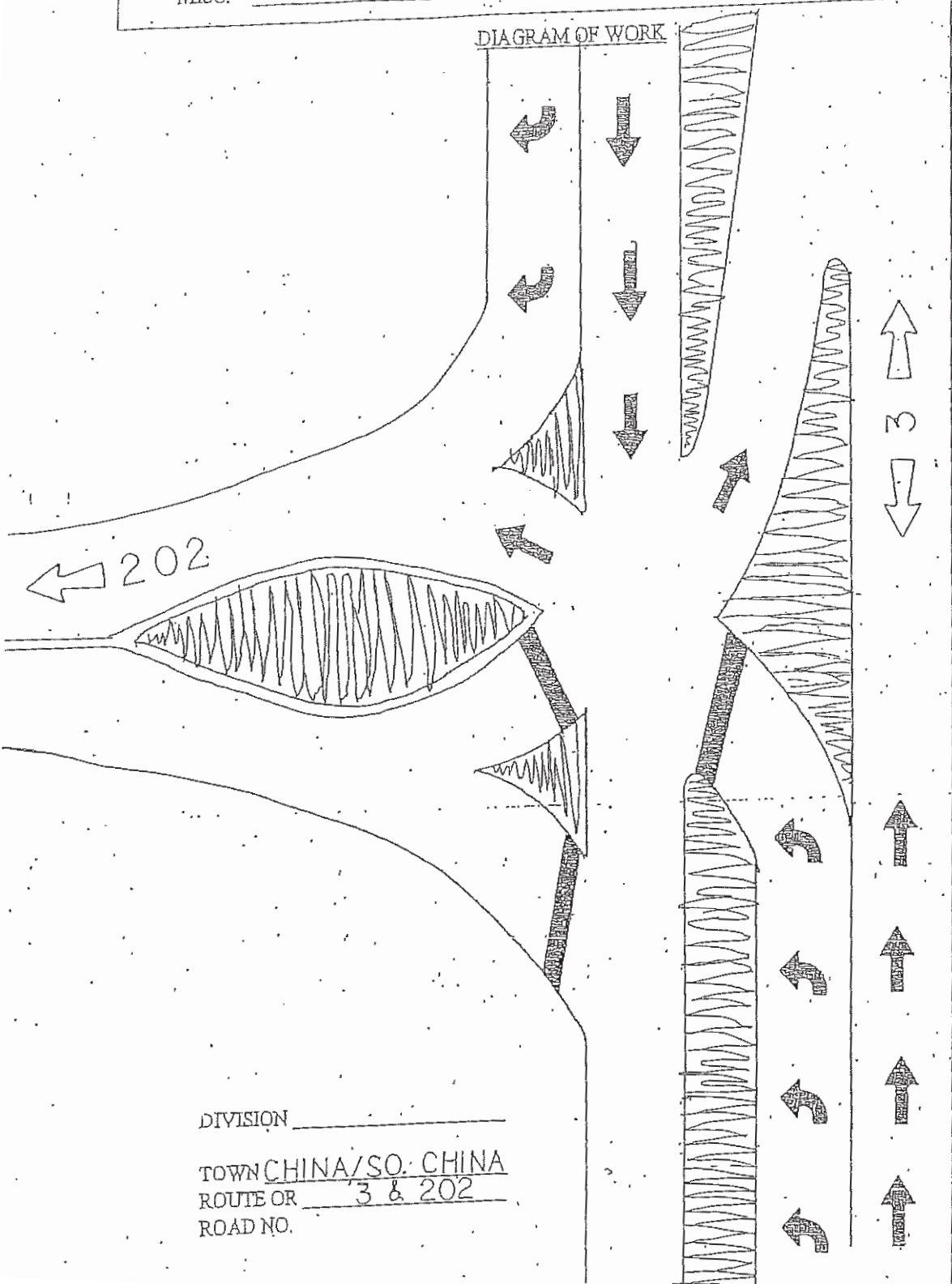

DIVISION _____

TOWN CHINA/SO. CHINA
 ROUTE OR 3 & 202
 ROAD NO.

PAVEMENT MARKINGS

Project No: _____

904343

DESCRIPTION OF WORK DONE

STRAIGHT ARROW _____	LANE LINE _____
TURN ARROW _____	STOP _____ 44 _____
STOP BAR <u>126</u> _____	ONLY _____
CURBING-YELLOW _____	STOP AHEAD _____
WHITE <u>70</u> _____	CROSSWALKS _____
HASH MARKS _____	TOTAL SQ. FT. <u>240</u> _____
MISC. _____	

DIAGRAM OF WORK

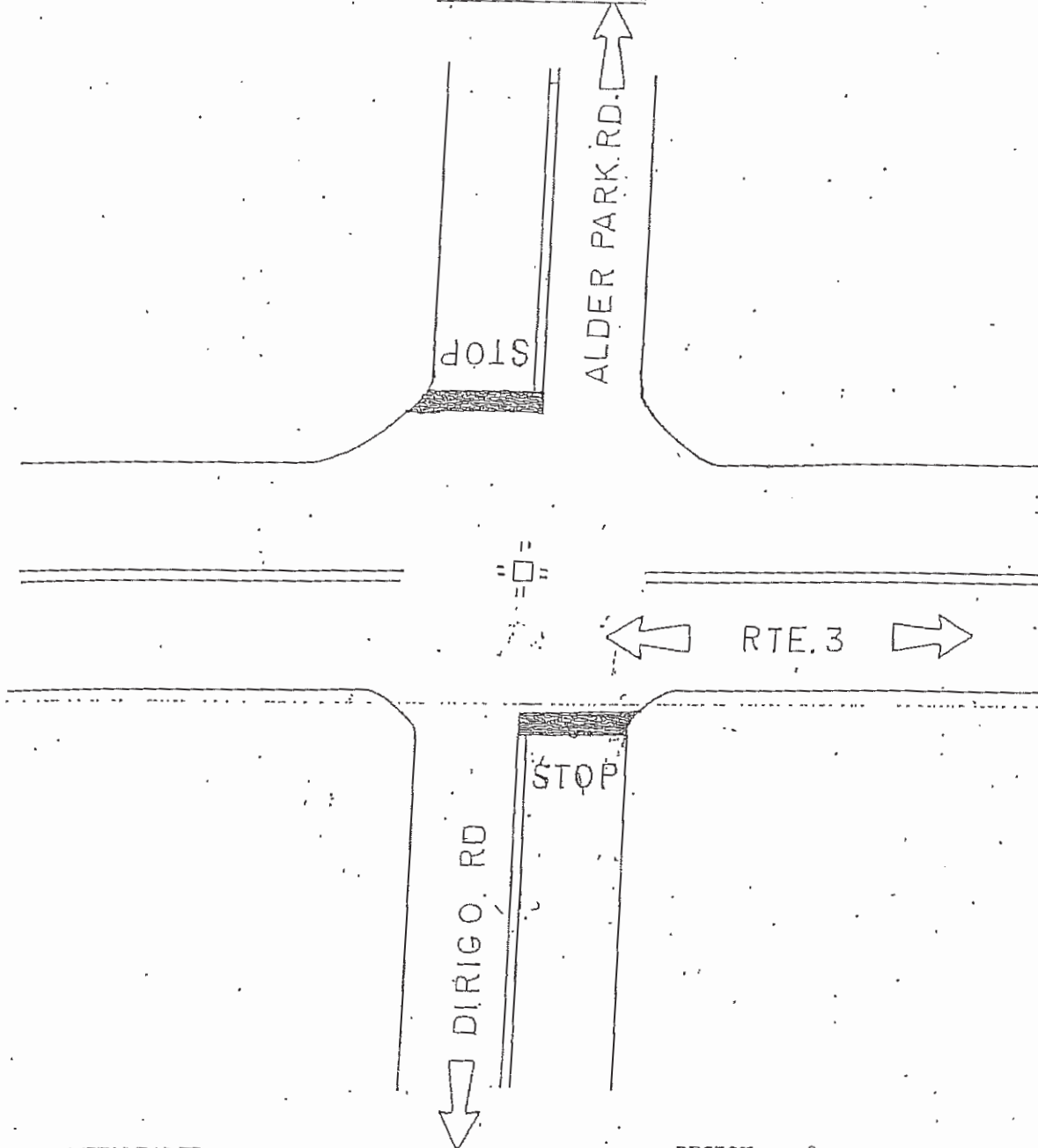

CREW LEADER _____
YES NO

REGION 2

160

TOWN SO. CHINA / CHINA

904367

PAVEMENT MARKINGS

Project No.

904367

DESCRIPTION OF WORK DONE

STRAIGHT ARROW	26	LANE LINE	
TURN ARROW	32	STOP	
STOP BAR		ONLY	
CURBING-YELLOW		STOP AHEAD	
WHITE		CROSSWALKS	
HASHMARKS		201&95	54
MISC. NORTH&SOUTH	113	TOTAL SQ. FT.	225

DIAGRAM OF WORK

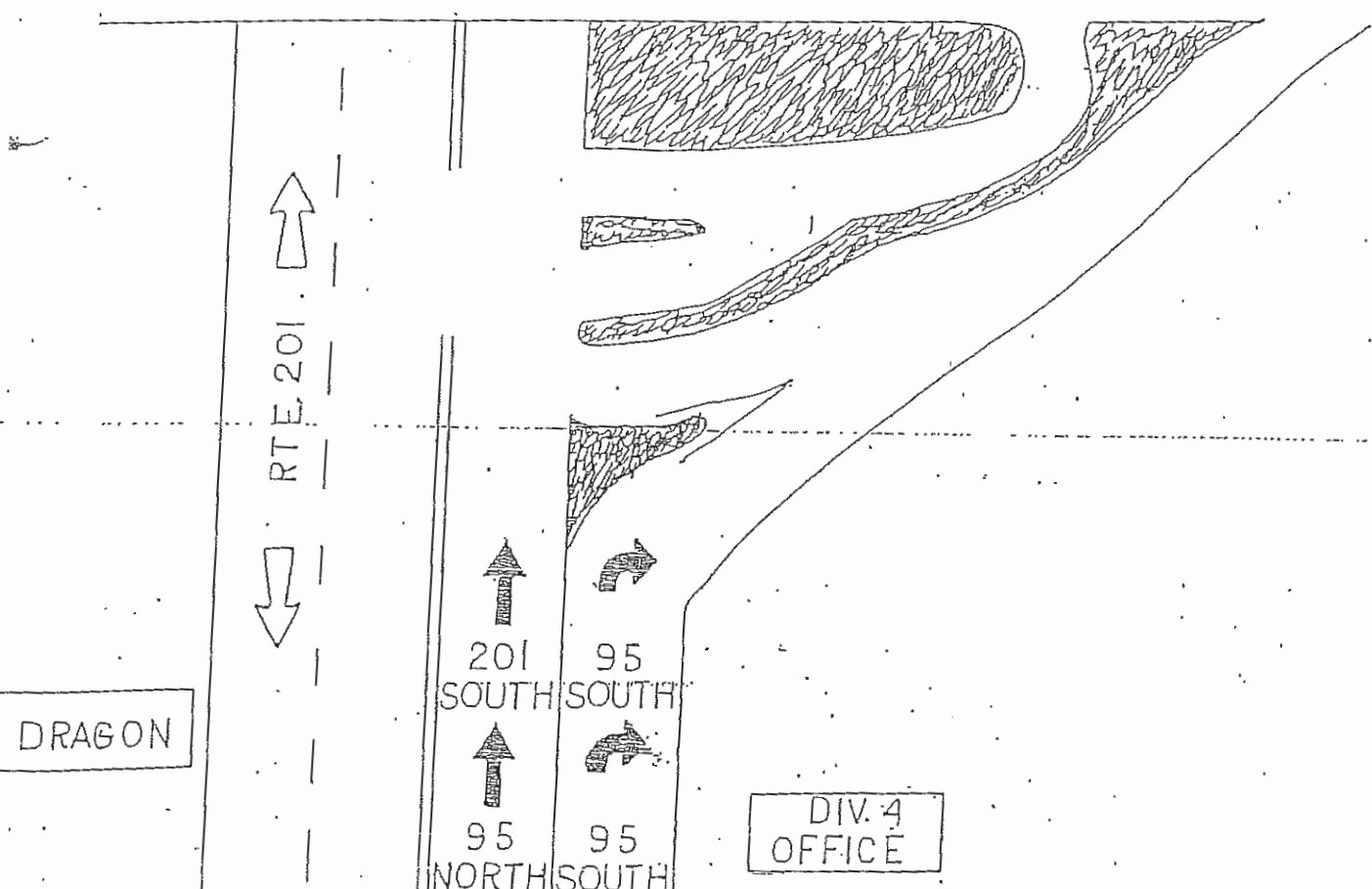
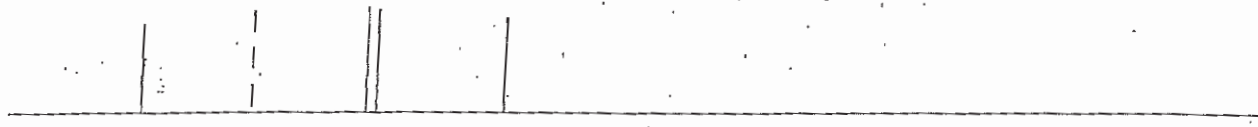

CREW LEADER _____ YES NO

REGION 2 _____

TOWN FAIRFIELD

PAVEMENT MARKINGS

Project No. _____

928706

DESCRIPTION OF WORK DONE

STRAIGHT ARROW _____	LANE LINE _____
TURN ARROW _____	STOP 22 _____
STOP BAR 34 _____	ONLY _____
CURBING-YELLOW _____	STOP AHEAD 39 _____
WHITE _____	CROSSWALKS _____
HASH MARKS _____	TOTAL SQ. FT. 95 _____
MISC. _____	

DIAGRAM OF WORK

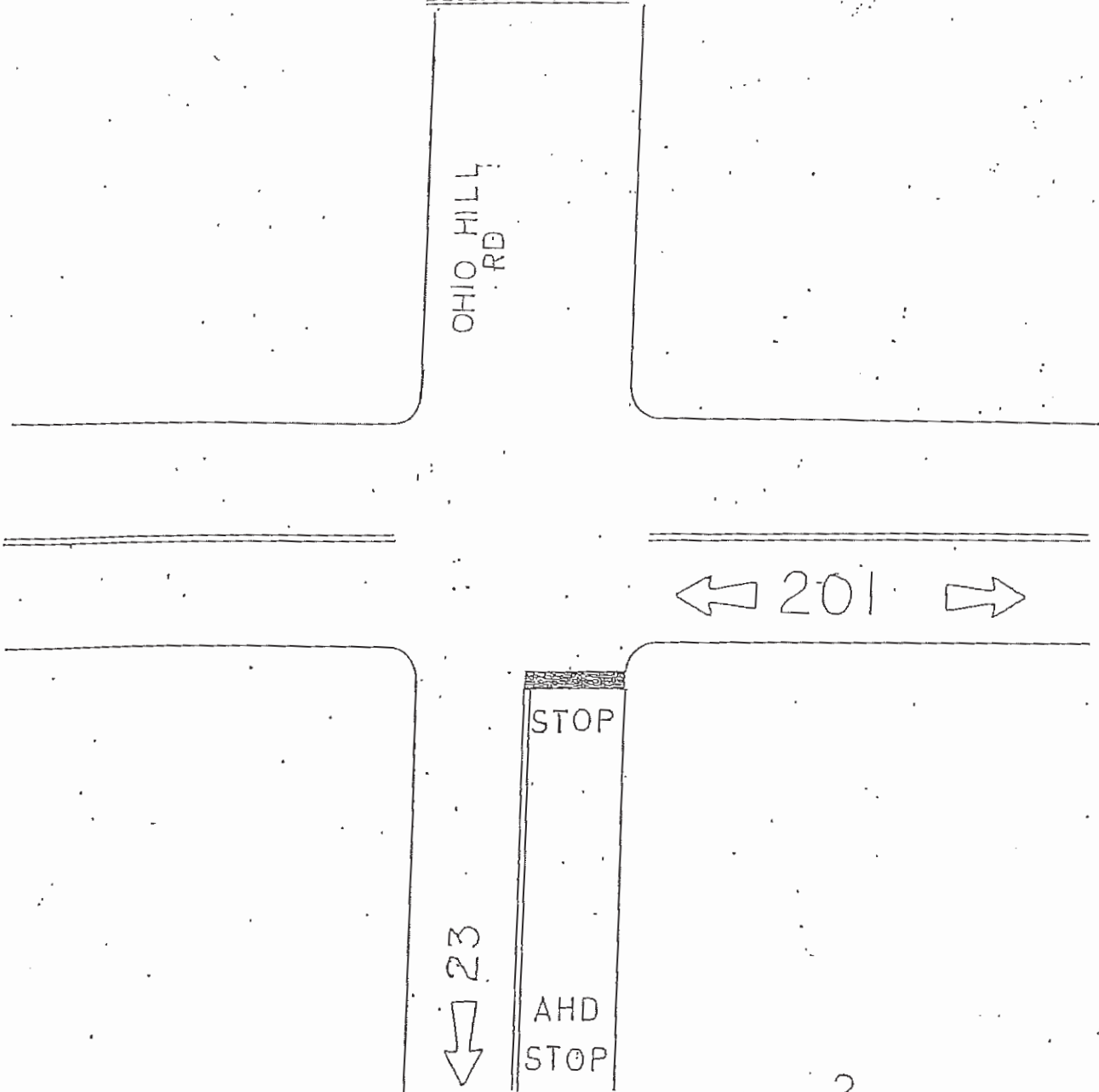

CREW LEADER _____ YES NO
 PROJECT DONE BEFORE _____
 DATE _____
 ACTUAL JOB TIME _____

REGION 2
 TOWN FAIRFIELD
 ROUTE OR 23 & 201
 ROAD NO. _____

PAVEMENT MARKINGS

953191

Project No. _____

953191

DESCRIPTION OF WORK DONE

STRAIGHT ARROW _____	LANE LINE _____
TURN ARROW _____ 64	STOP _____
STOP BAR _____	ONLY _____
CURBING-YELLOW _____	STOP AHEAD _____
WHITE _____	CROSSWALKS _____
HASH MARKS _____ 285	TOTAL SQ. FT. _____ 349
MISC. _____	

DIAGRAM OF WORK

HINKLEY
SCHOOL

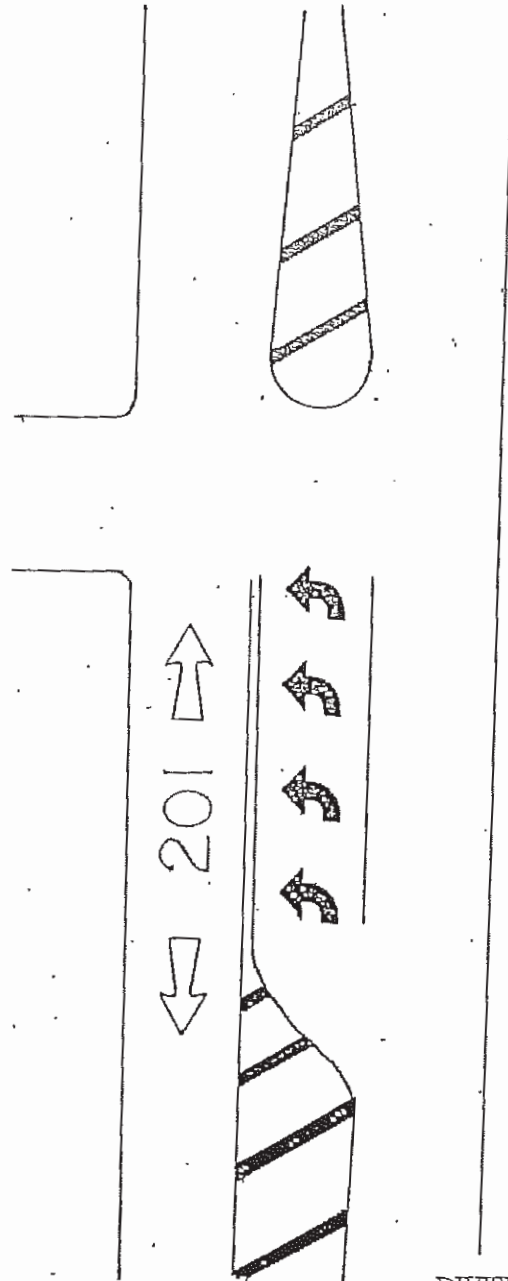

CREW LEADER _____ YES NO
 PROJECT DONE BEFORE _____
 DATE _____
 ACTUAL JOB TIME _____

DIVISION REG. 2
 TOWN FAIRFIELD
 ROUTE OR 201 & SCHOOL
 ROAD NO. _____

PAVEMENT MARKINGS

Project No. _____

DESCRIPTION OF WORK DONE

Fairfield		Asset:1053963
Total Sq. Feet:	72	Route 139 and Route 104
Stop Bar:	72	

DIAGRAM OF WORK

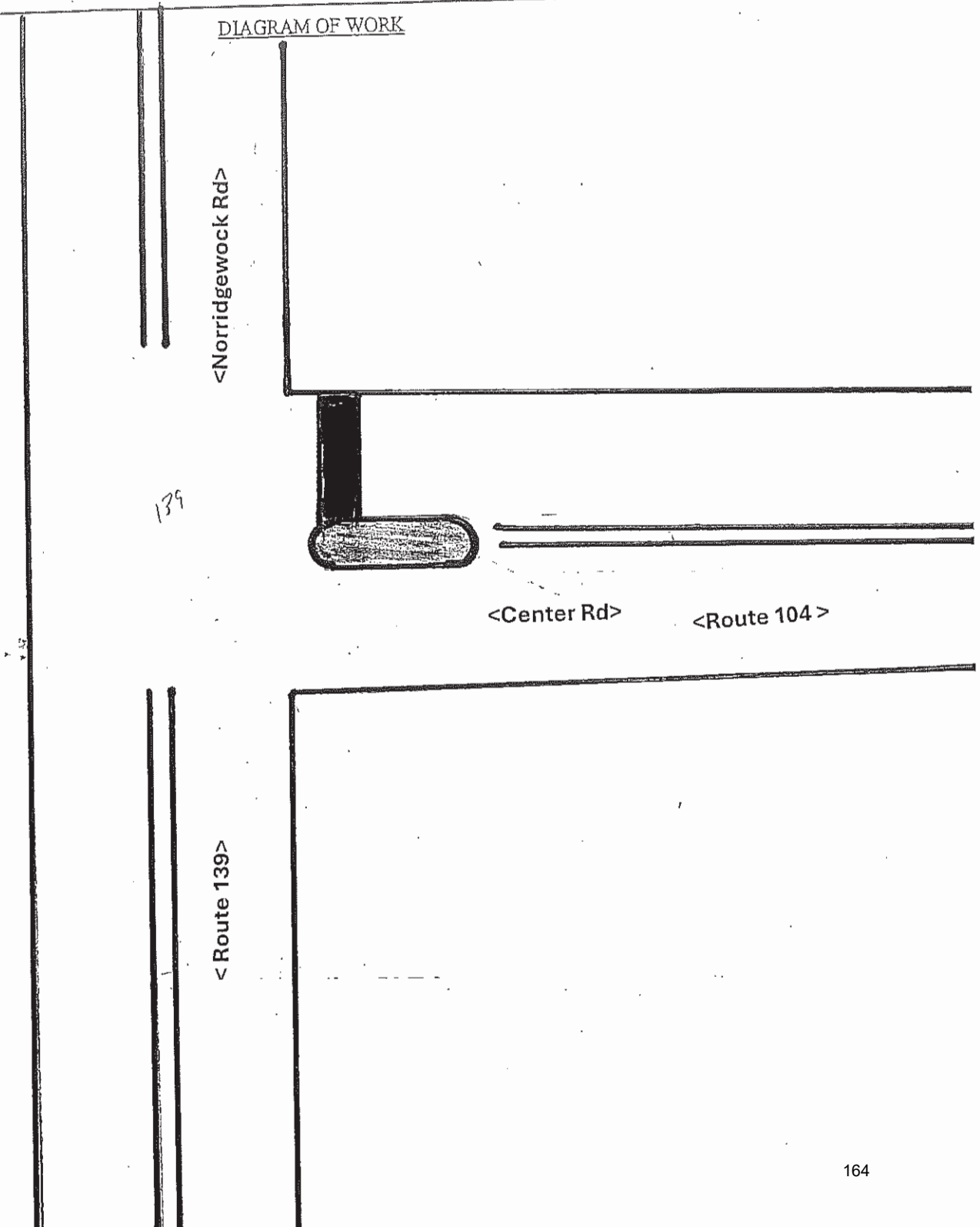

PAVEMENT MARKINGS

Project No. _____

DESCRIPTION OF WORK DONE

Fairfield

Asset: 1053961

Total Sq. Feet: 92

Route 104 and Route 139

Stop Bar: 92

DIAGRAM OF WORK

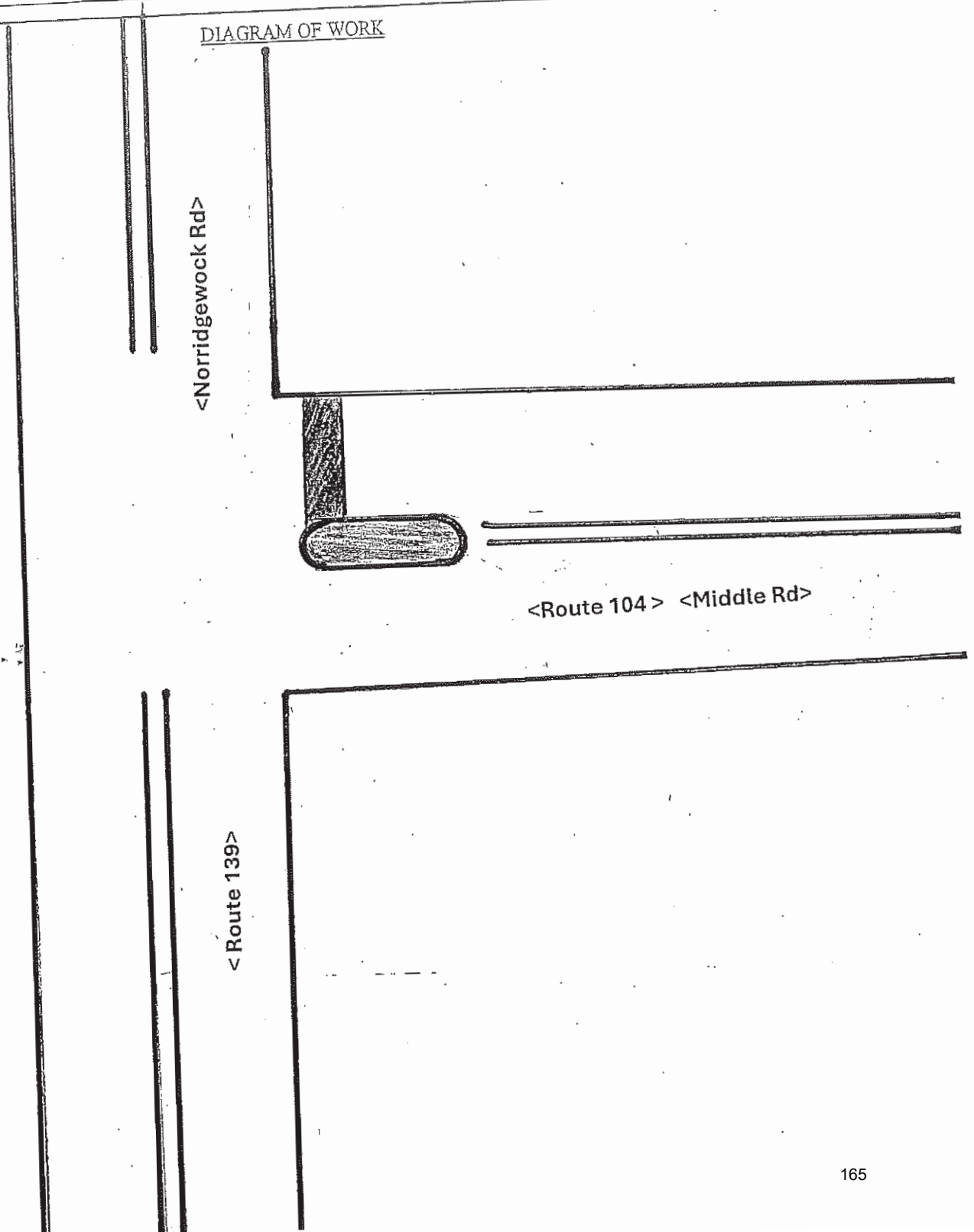

404.581

PAVEMENT MARKINGS

Project No. _____

904387

DESCRIPTION OF WORK DONE

STRAIGHT ARROW _____	LANE LINE _____
TURN ARROW _____	STOP _____ 66 _____
STOP BAR _____ 112 _____	ONLY _____
CURBING-YELLOW _____	STOP AHEAD _____ 147 _____
WHITE _____	CROSSWALKS _____
HASH MARKS _____	TOTAL SQ. FT. _____ 325 _____
MISC. _____	

DIAGRAM OF WORK

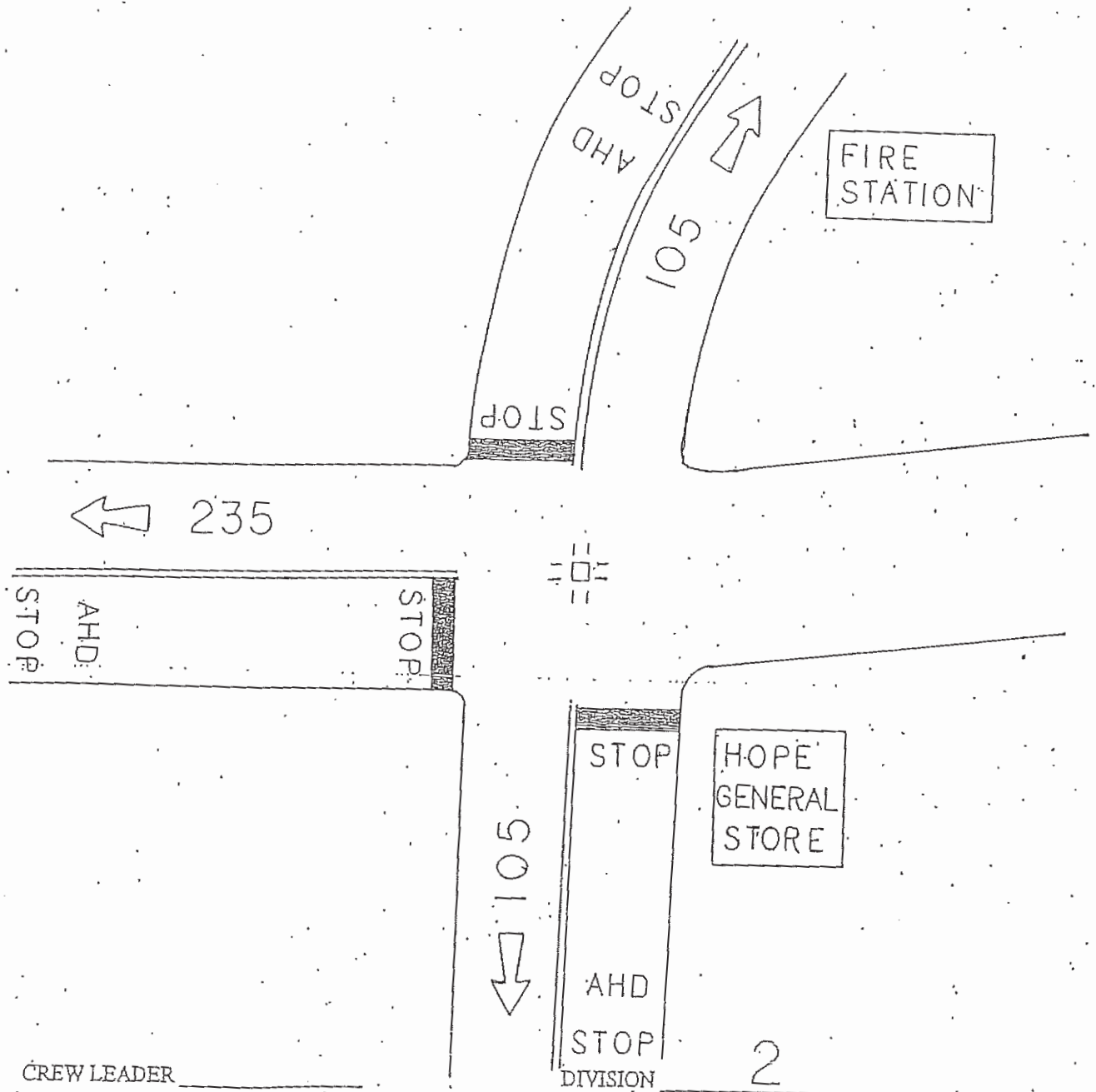

CREW LEADER _____ YES NO

PROJECT DONE BEFORE _____
DATE _____

TOWN HOPE
ROUTE OR 105 & 235
ROAD NO _____

PAVEMENT MARKINGS

904346

Project No.

904346

DESCRIPTION OF WORK DONE

STRAIGHT ARROW	_____	LANE LINE	_____
TURN ARROW	_____	STOP	22
STOP BAR	60	ONLY	_____
CURBING-YELLOW	58	STOP AHEAD	39
WHITE	103	CROSSWALKS	_____
HASH MARKS	_____	TOTAL SQ. FT.	282
MISC.	_____		

DIAGRAM OF WORK

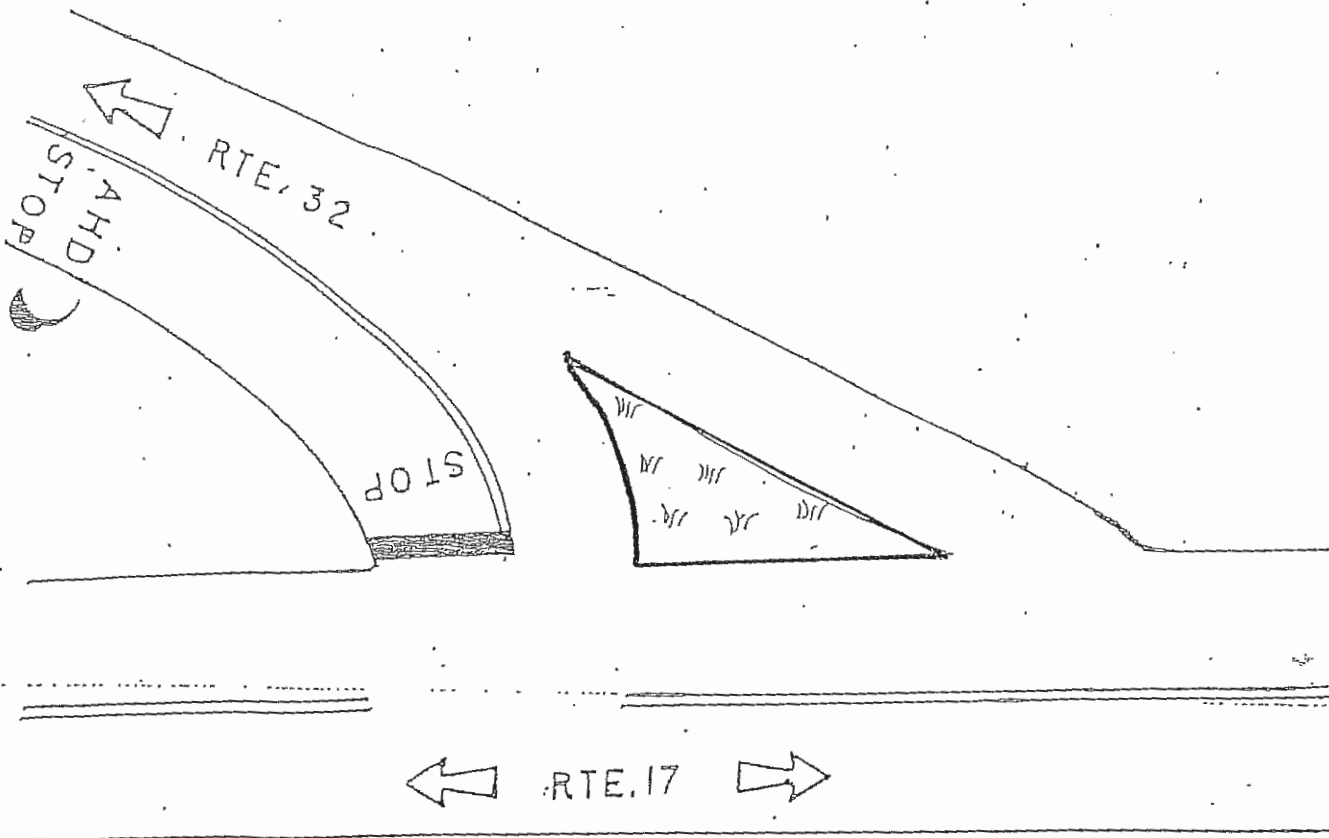

CREW LEADER _____

REGION 2

PROJECT DONE BEFORE _____ YES NO

TOWN JEFFERSON

DATE _____

ROUTE OR 17 & 32

ACTUAL JOB TIME _____

ROAD NO.

PAVEMENT MARKINGS

Project No. _____

Jefferson

Asset: 904389

Total Sq. Feet: 101

Stop Bar: 42

Stop: 22

Stop AHD: 37

Route 32 and East Pond Rd.

DIAGRAM OF WORK

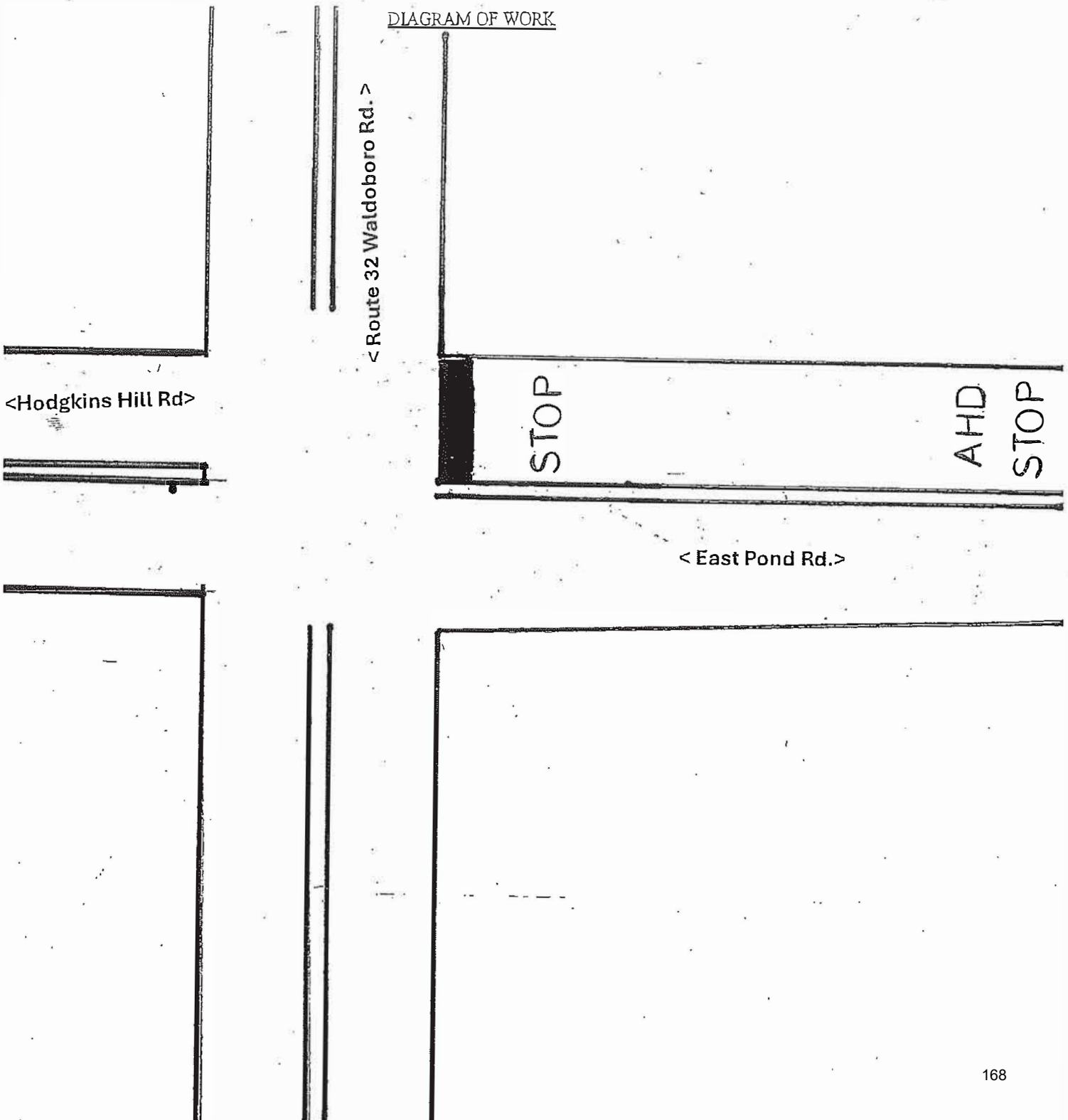

PAVEMENT MARKINGS

Project No. _____

DESCRIPTION OF WORK DONE

Jefferson		Asset:1034356
Total Sq. Feet:	24	Route 126 and Route 32
Stop Bar:	24	

DIAGRAM OF WORK

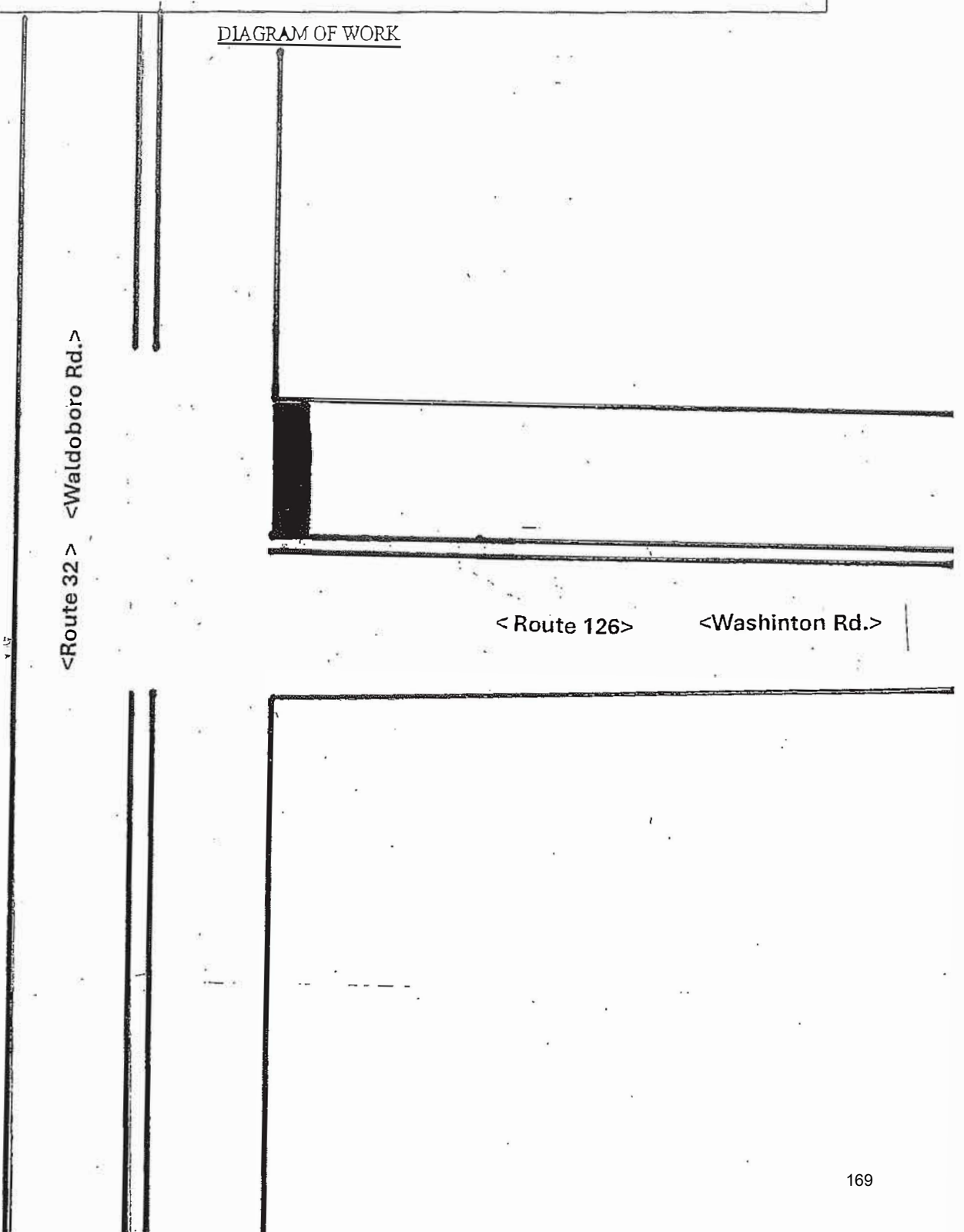

PAVEMENT MARKINGS

Project No. _____

DESCRIPTION OF WORK DONE

Jefferson		Asset: 998537
Total Sq. Feet:	88	Route 32 and Route 213
Stop Bar:	88	

DIAGRAM OF WORK

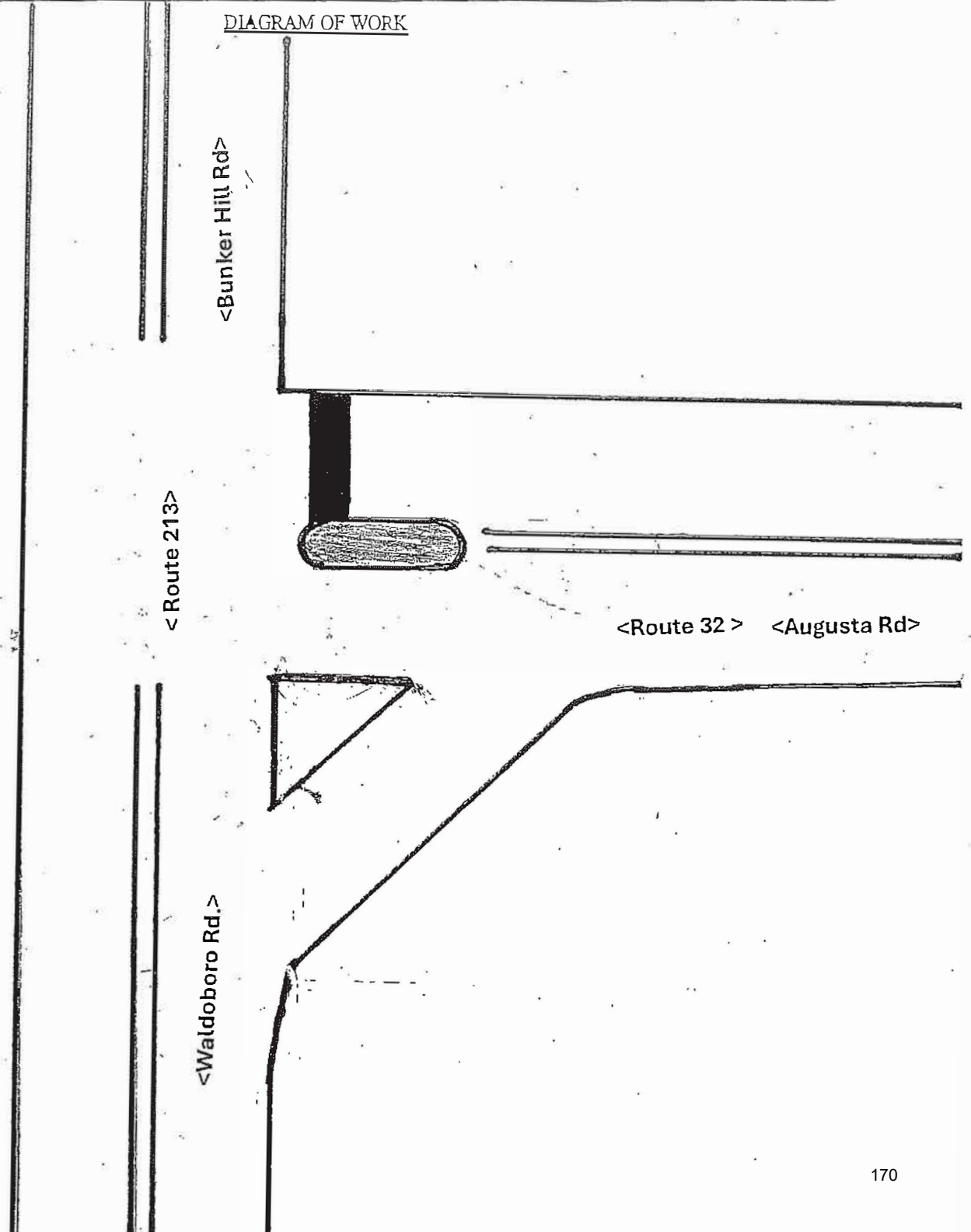

PAVEMENT MARKINGS

Project No. _____

DESCRIPTION OF WORK DONE

Jefferson		Asset:1034358
Total Sq. Feet:	102	Route 213 and Route 126
Stop Bar:	102	

DIAGRAM OF WORK

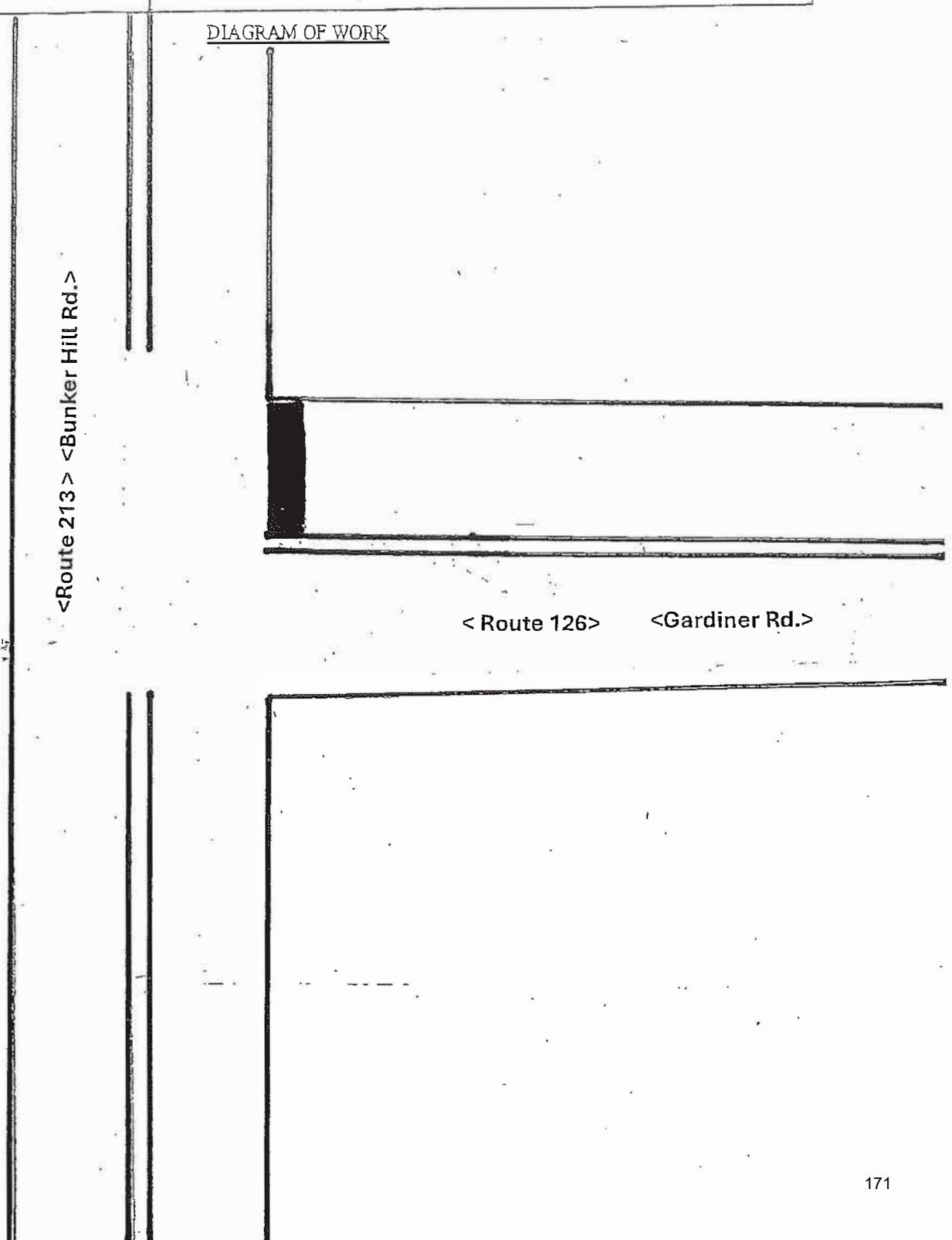

PAVEMENT MARKINGS

Project No. _____

DESCRIPTION OF WORK DONE

Jefferson		Asset: 1034360
Total Sq. Feet:	124	Route 215 and Route 126
Stop Bar:	124	

DIAGRAM OF WORK

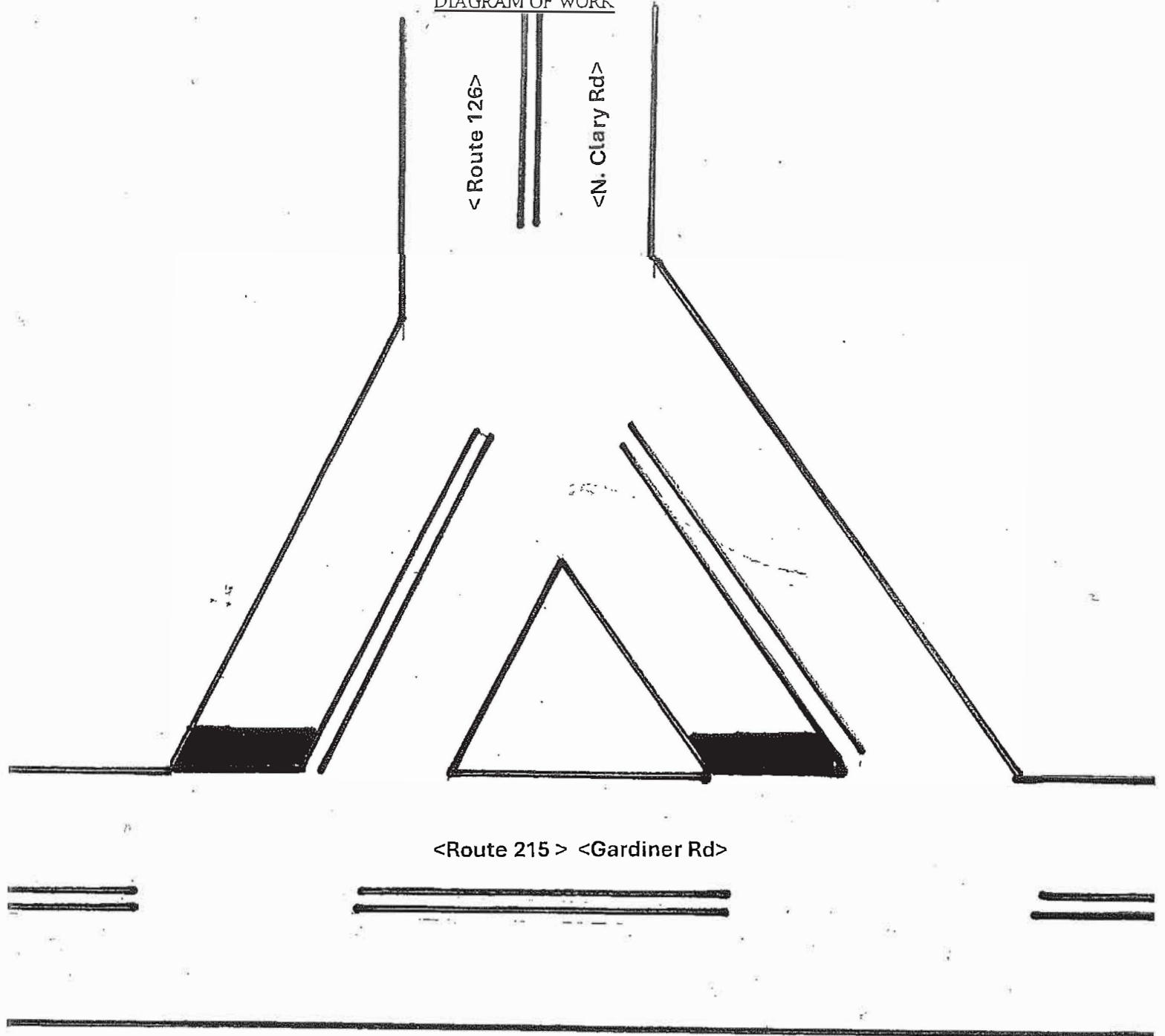

PAVEMENT MARKINGS

Project No.

DESCRIPTION OF WORK DONE

Jefferson

Asset:1034362

Total Sq. Feet: 60

Route 215 and Route 32

Stop Bar: 60

DIAGRAM OF WORK

<Augusta Rd>

<Route 32 > , <N. Clary Rd>

<Route 215>

PAVEMENT MARKINGS

Project No. _____

928708

DESCRIPTION OF WORK DONE

STRAIGHT ARROW _____	LANE LINE _____
TURN ARROW _____	STOP _____ 22 _____
STOP BAR _____ 40 _____	ONLY _____
CURBING-YELLOW _____	STOP AHEAD _____ 39 _____
WHITE _____	CROSSWALKS _____
HASH MARKS _____	TOTAL SQ. FT. _____ 101 _____
MISC. _____	

DIAGRAM OF WORK



CREW LEADER _____

YES NO

PROJECT DONE BEFORE _____

DATE _____

ACTUAL JOB TIME _____

REGION 2

TOWN LEEDS

ROUTE OR 202 & 106

ROAD NO. _____

Project No. 904393

904393

DESCRIPTION OF WORK DONE

STRAIGHT ARROW _____	LANE LINE _____
TURN ARROW _____	STOP _____ <u>22</u>
STOP BAR _____ <u>56</u>	ONLY _____
CURBING-YELLOW _____ <u>96</u>	STOP AHEAD _____ <u>37</u>
WHITE _____	CROSSWALKS _____
HASH MARKS _____	TOTAL SQ. FT. _____ <u>236</u>
MISC. <u>YIELD</u> <u>25</u>	

DIAGRAM OF WORK

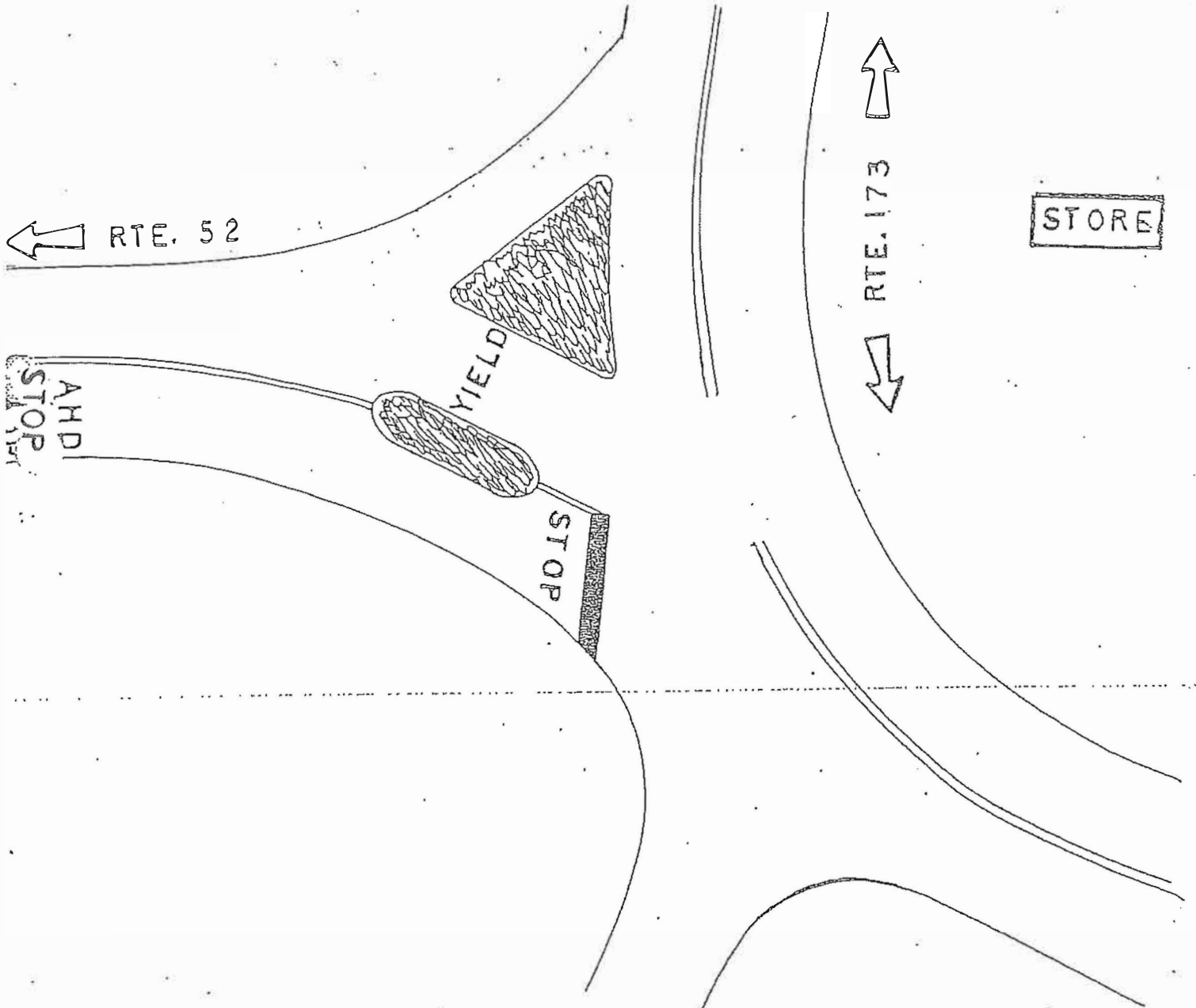

CREW LEADER _____ YES NO

PROJECT DONE BEFORE _____

DATE _____

ACTUAL JOB TIME _____

REGION 2

TOWN LINCOLNVILLE CTR.

ROUTE OR 52 & 173

ROAD NO. _____

PAVEMENT MARKINGS

Project No. _____

Lincolnvile

Asset: 1053639

Total Sq Feet: 54

Stop Bar: 54

Route 173 Main St. and Route 52 Belfast Road

DIAGRAM OF WORK

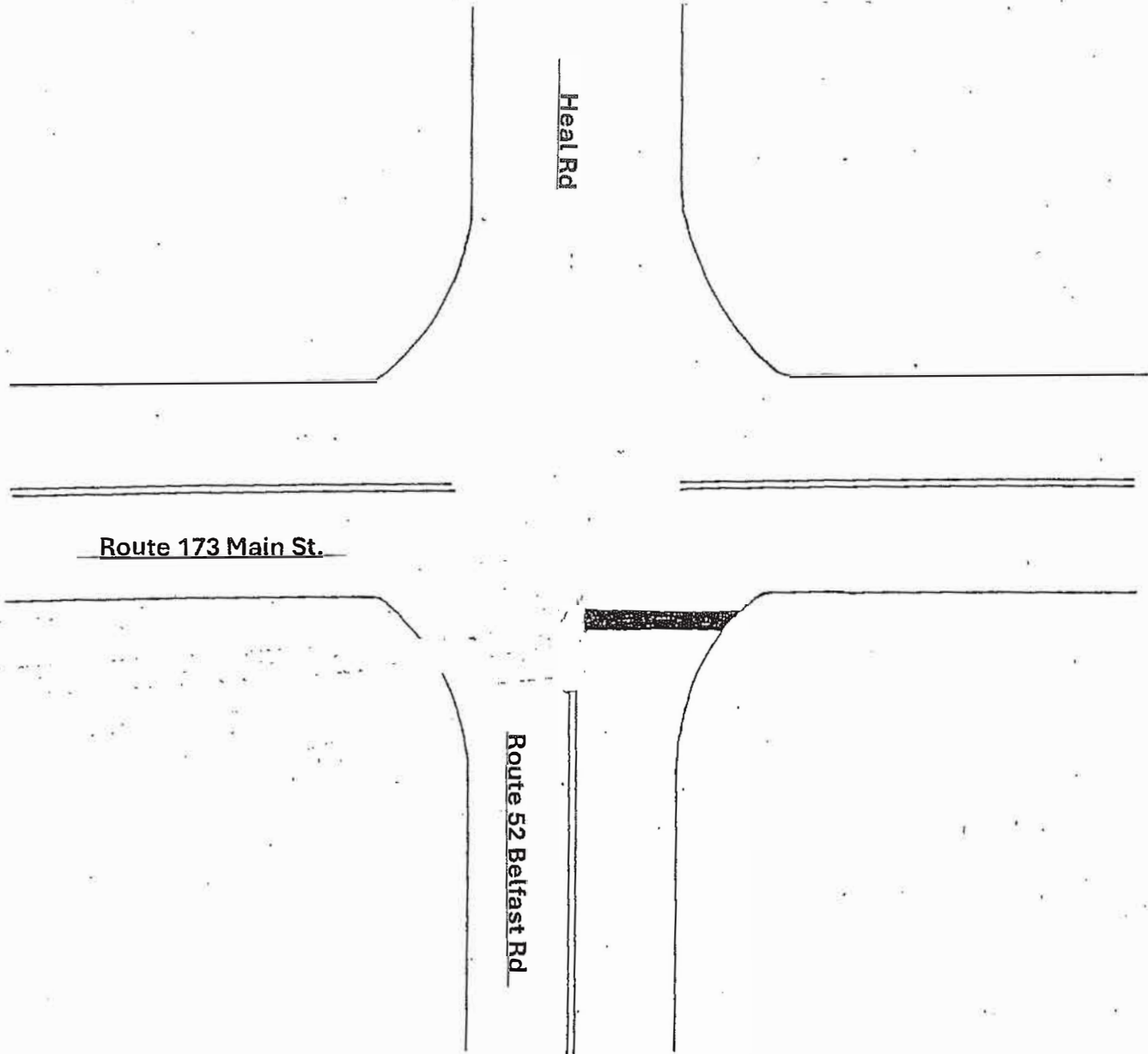

CREW LEADER _____ YES NO

PROJECT DONE BEFORE _____

DATE _____

ACTUAL JOB TIME _____

TOWN _____

ROUTE OR _____

ROAD NO. _____

PAVEMENT MARKINGS

Project No. _____

Lincolnvile

Asset: 1080696

Total Sq Feet: 20

Stop Bar: 20

Route 235 Hope Rd and Route 173 Main St

Route 173 Main St

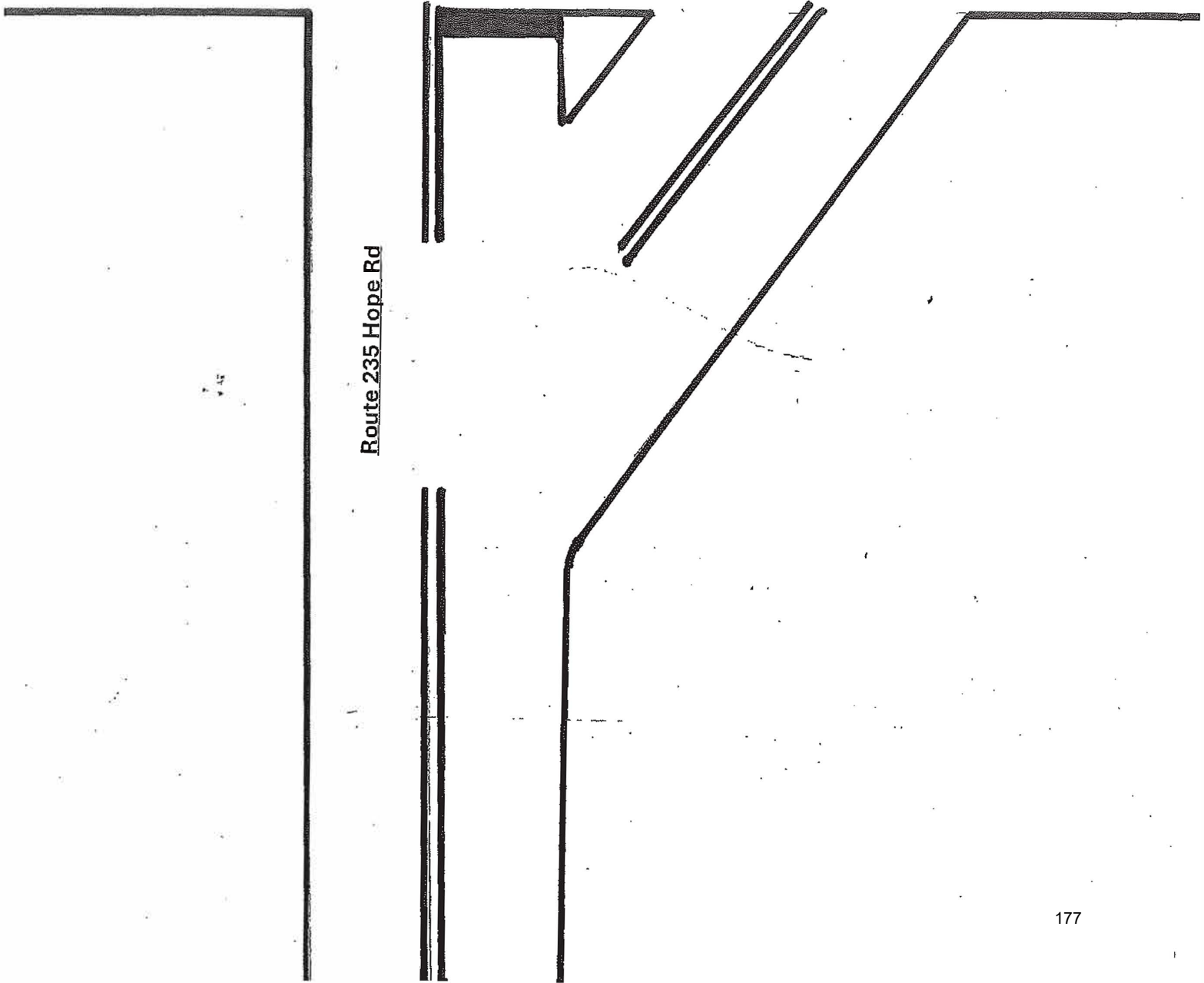

904457

PAVEMENT MARKINGS

Project No.

904457

DESCRIPTION OF WORK DONE

STRAIGHT ARROW _____	LANE LINE _____
TURN ARROW _____	STOP _____ 22
STOP BAR _____ 60	ONLY _____
CURBING-YELLOW _____	STOP AHEAD _____ 37
WHITE _____ 100	CROSSWALKS _____
HASH MARKS _____	TOTAL SQ. FT. _____ 219
MISC. _____	

DIAGRAM OF WORK

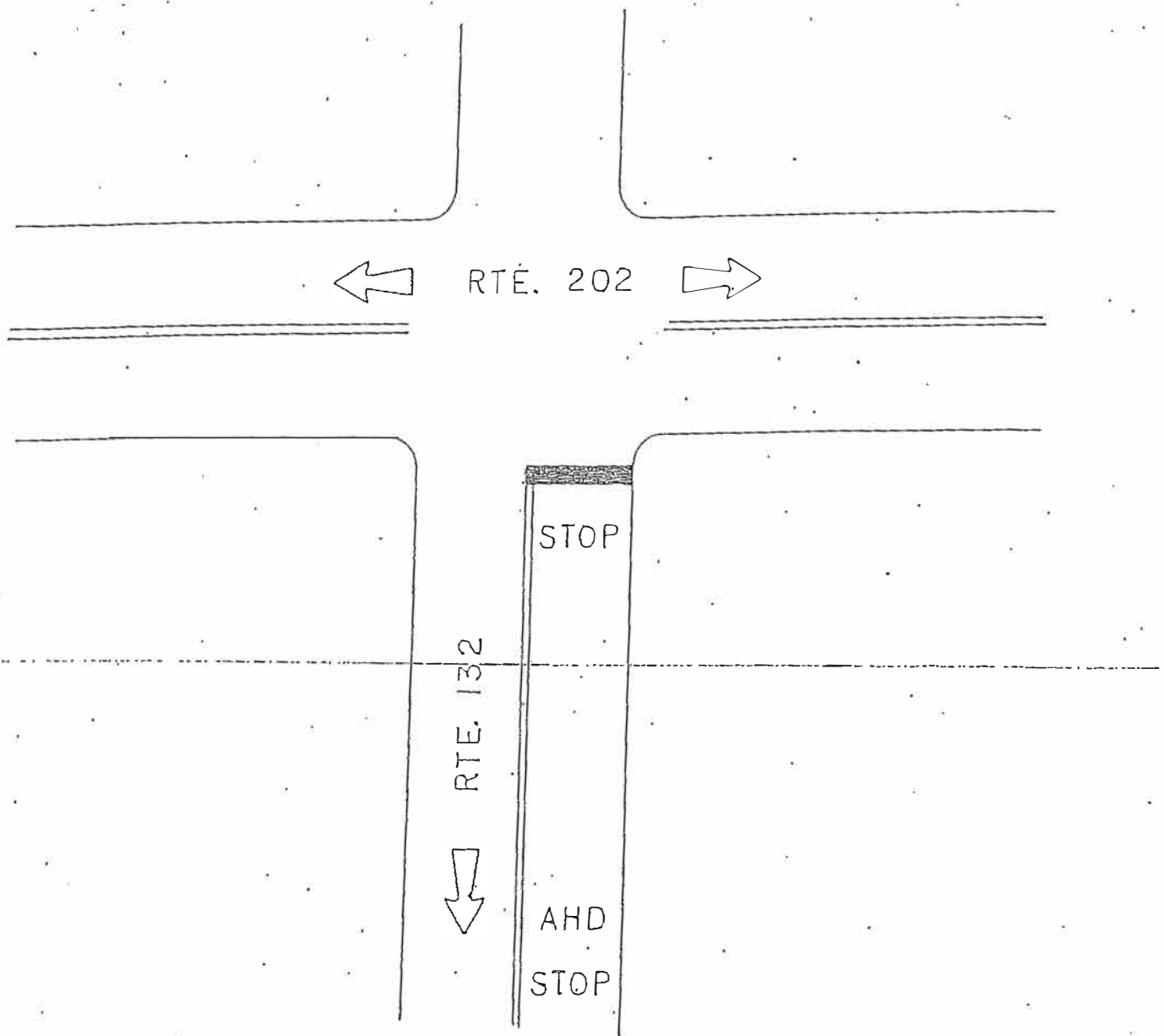

CREW LEADER _____

1

REGION 2

178

PROJECT DONE BEFORE _____ YES NO

TOWN MONMOUTH
ROUTE OF 132 & 202

PAVEMENT MARKINGS

Project No. _____

DESCRIPTION OF WORK DONE

Monmouth Asset:1081288
Total Sq. Feet: 24 Route 135 and Route 132
Stop Bar: 24

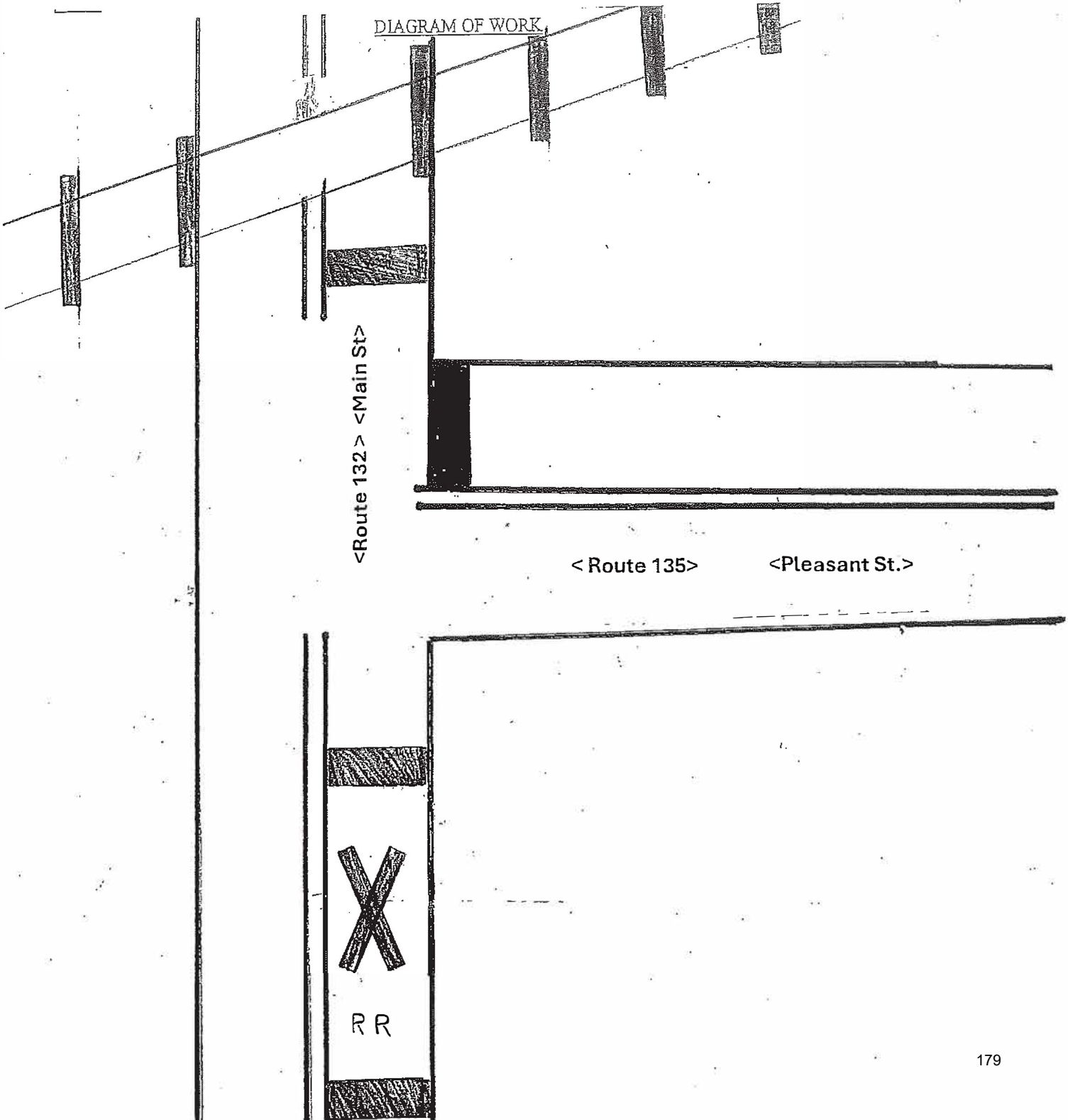

904500

PAYEMENT MARKINGS

Project No. _____

904500

DESCRIPTION OF WORK DONE

STRAIGHT ARROW _____	LANE LINE _____
TURN ARROW _____	STOP _____ 22 _____
STOP BAR _____ 60 _____	ONLY _____
CURBING-YELLOW _____	STOP AHEAD _____ 37 _____
WHITE _____	CROSSWALKS _____
HASH MARKS _____	TOTAL SQ. FT. _____ 119 _____
MISC. _____	

DIAGRAM OF WORK

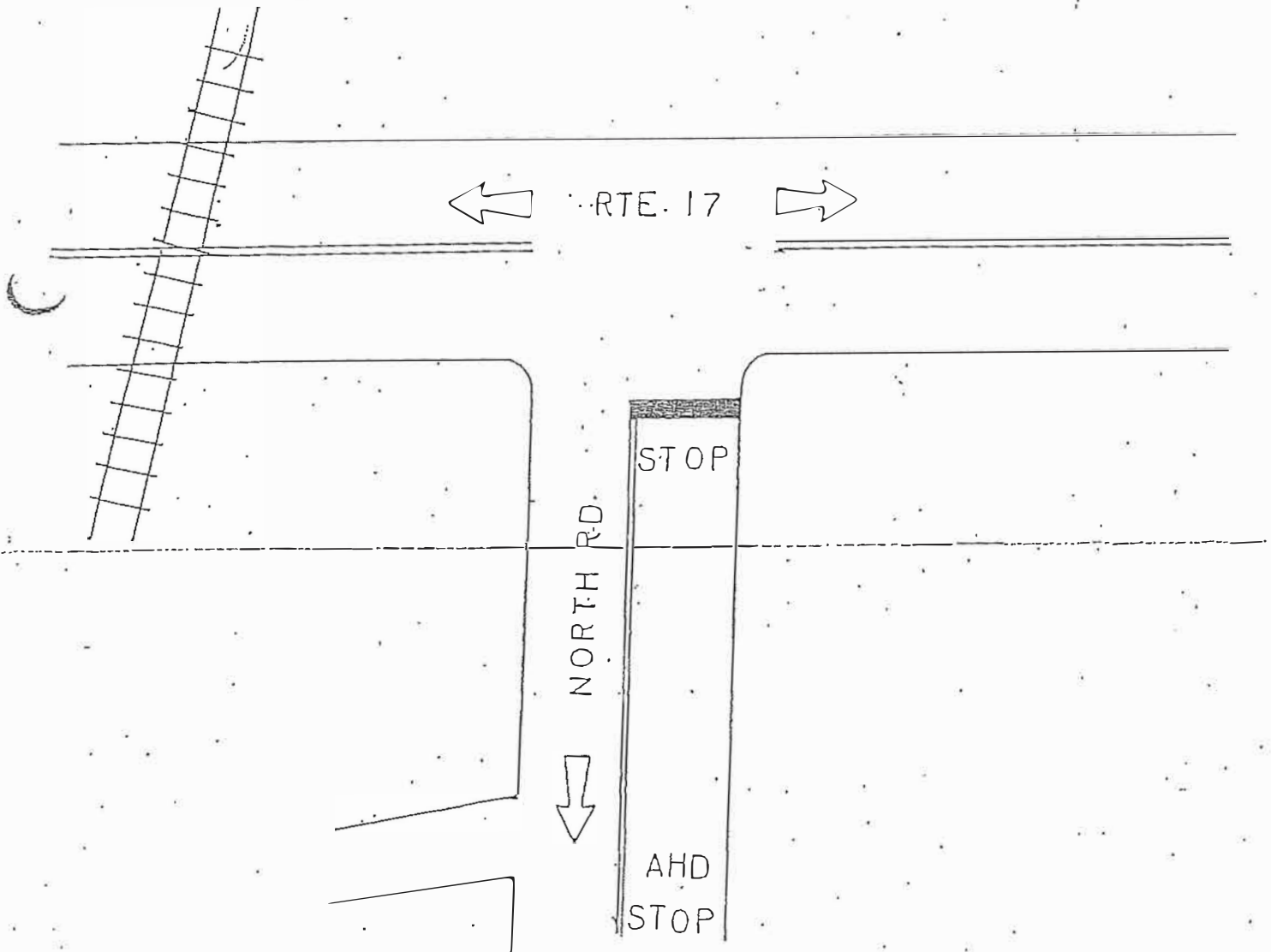

CREW LEADER _____ YES NO

REGION 2

181

TOWN READEFIELD

904503

PAVEMENT MARKINGS

Project No. _____

904503

DESCRIPTION OF WORK DONE

STRAIGHT ARROW _____	LANE LINE _____
TURN ARROW _____	STOP _____ 22 _____
STOP BAR _____ 32 _____	ONLY _____
CUREING-YELLOW _____	STOP AHEAD _____
WHITE _____ 134 _____	CROSSWALKS _____
HASH MARKS _____	TOTAL SQ. FT. _____ 188 _____
MISC. _____	

DIAGRAM OF WORK



CREW LEADER _____ YES NO

REGION 2

PROJECT DONE BEFORE _____
DATE _____

TOWN READFIELD
ROUTE OR 17 & 41

904505

PAVEMENT MARKINGS

Project No. _____

904505

DESCRIPTION OF WORK DONE

STRAIGHT ARROW _____	LANE LINE _____
TURN ARROW _____	STOP _____
STOP BAR _____ 70 _____	ONLY _____
CURBING-YELLOW _____	STOP AHEAD _____ 37 _____
WHITE _____	CROSSWALKS _____
HASH MARKS _____	TOTAL SQ. FT. _____ 107 _____
MISC. _____	

DIAGRAM OF WORK

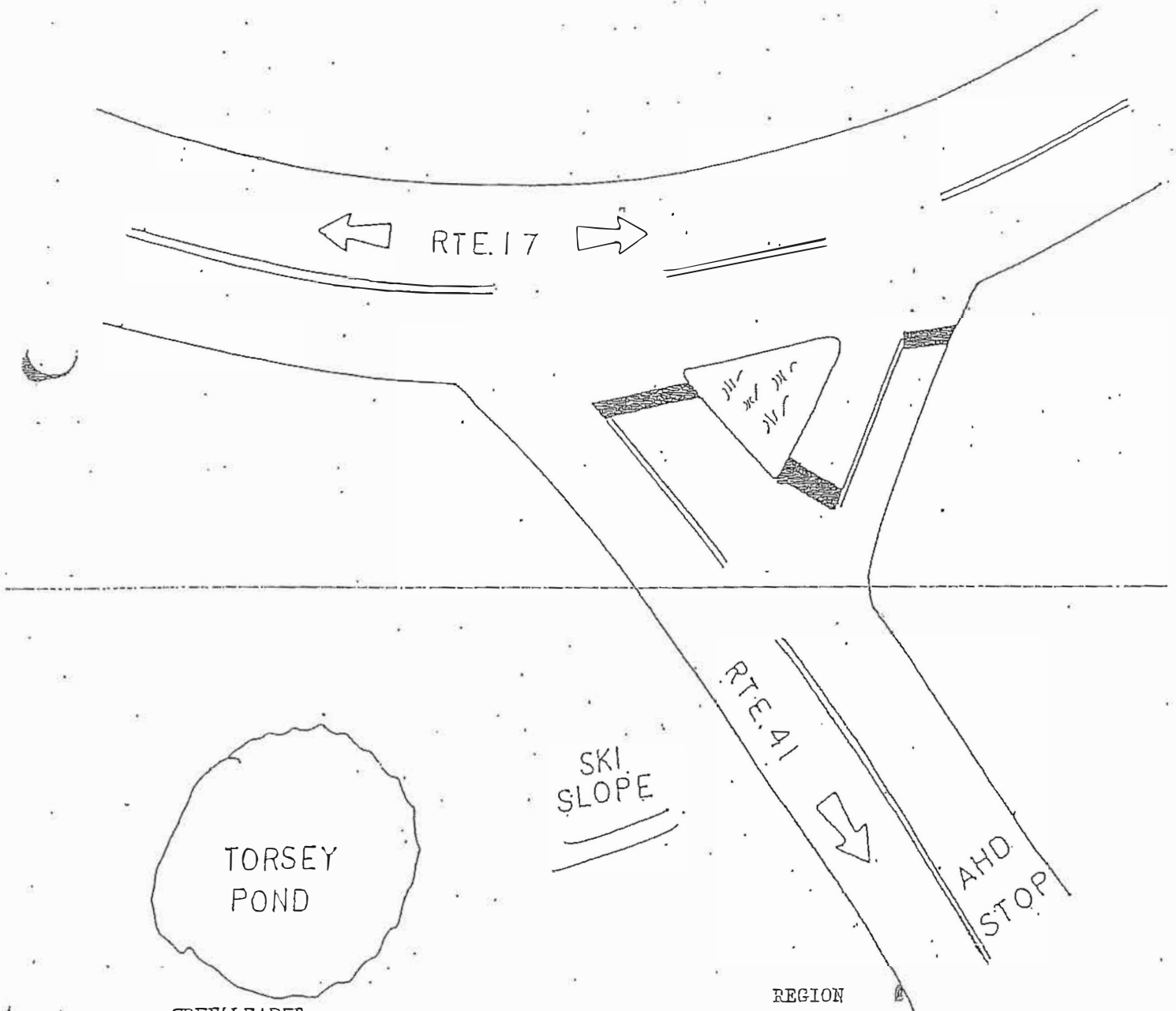

CREW LEADER _____ YES NO
 PROJECT DONE BEFORE _____

REGION _____

TOWN READFIELD/KENTS HILL 183
 ROUTE OR 17 & 41

PAVEMENT MARKINGS

Project No. _____

DESCRIPTION OF WORK DONE

<u>Readfield</u>		<u>Asset:1080424</u>
Total Sq. Feet:	60	Route 135 and Route 17
Stop Bar:	60	

DIAGRAM OF WORK

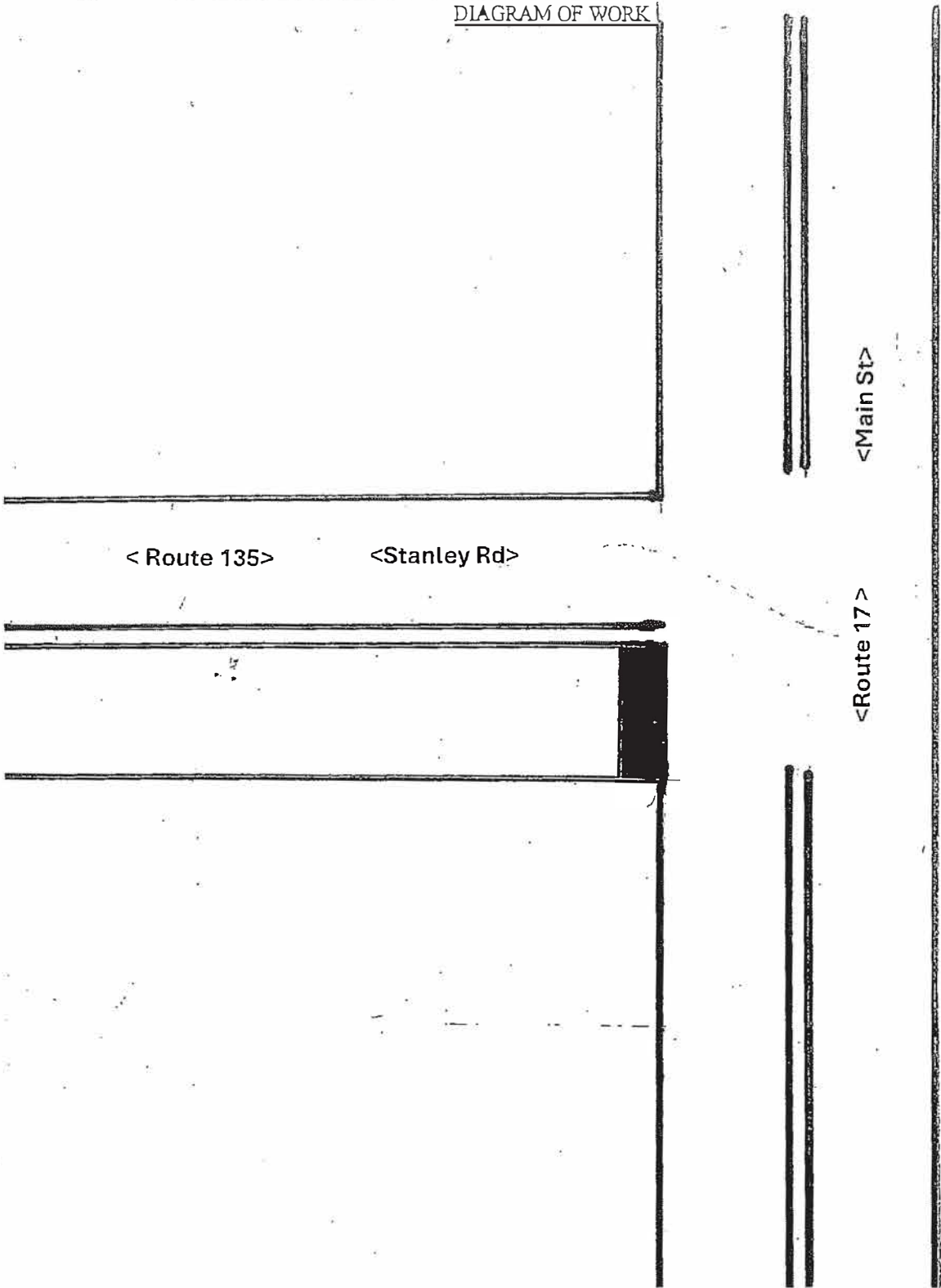

PAVEMENT MARKINGS

Project No. _____

DESCRIPTION OF WORK DONE

Readfield

Asset:1080422

Total Sq. Feet: 78

Route 135 and Route 17

Stop Bar: 78

DIAGRAM OF WORK

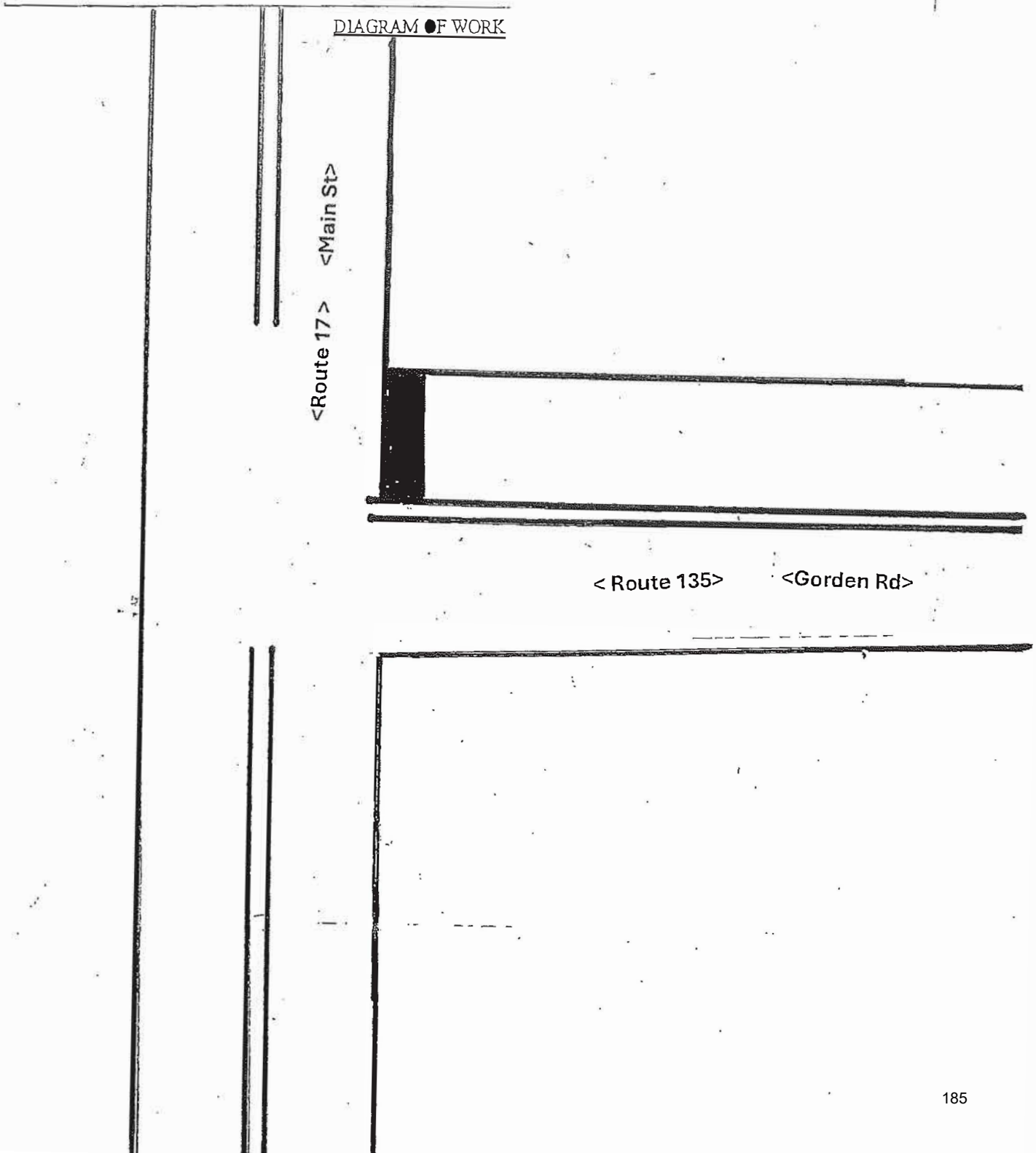

PAVEMENT MARKINGS

Project No. 904560

DESCRIPTION OF WORK DONE

STRAIGHT ARROW _____	LANE LINE _____
TURN ARROW <u>64</u>	STOP _____
STOP BAR <u>154</u>	ONLY _____
CURBING-YELLOW _____	STOP AHEAD _____
WHITE <u>27</u>	CROSSWALKS _____
HASH MARKS _____	TOTAL SQ. FT. <u>361</u>
MISC. <u>COMB. ARROW 16</u>	

DIAGRAM OF WORK

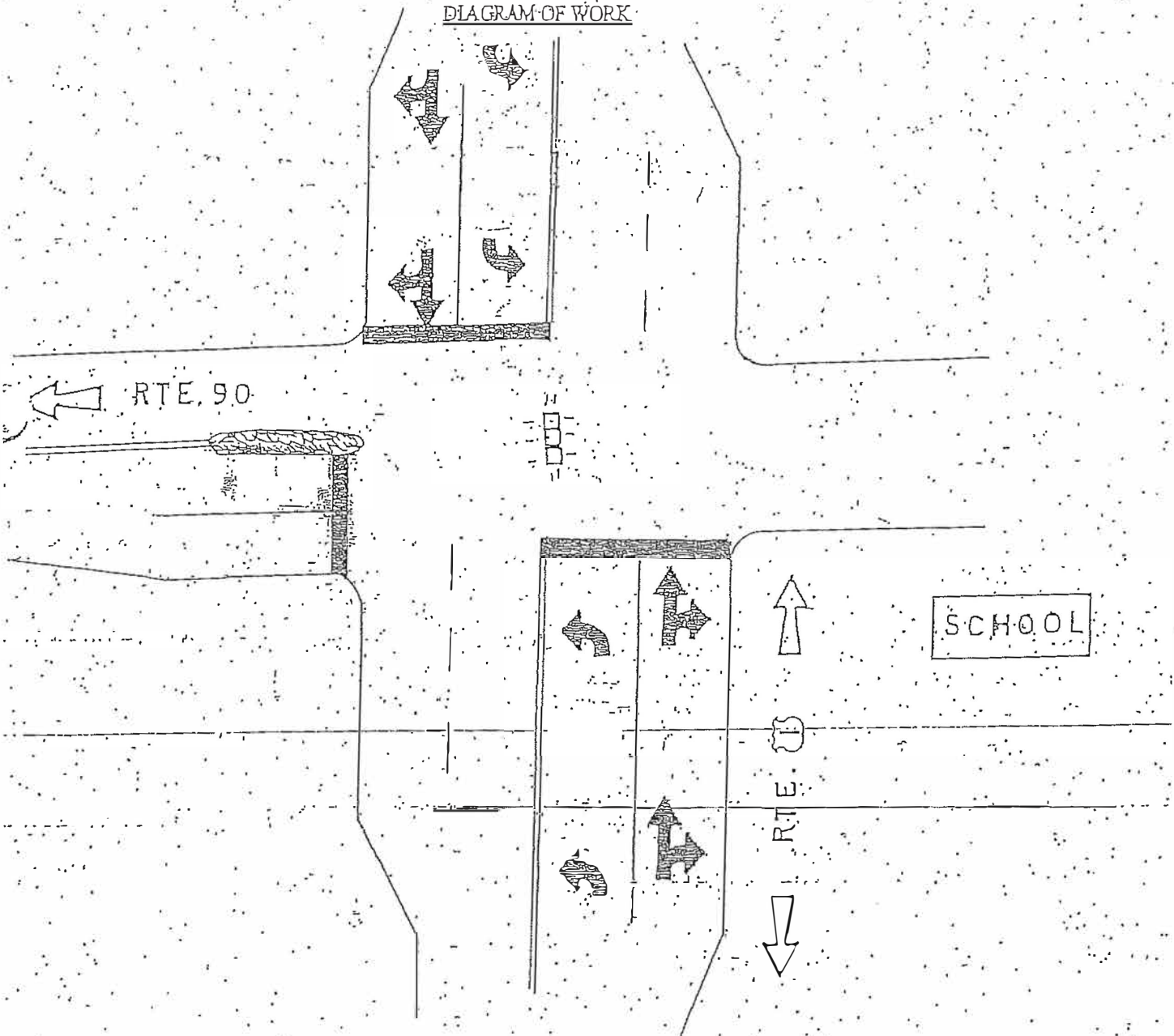

CREW LEADER _____

REGION 2

YES NO

PROJECT DONE BEFORE _____

DATE _____

ACTUAL JOB TIME _____

TOWN ROCKPORT

ROUTE OR US 90

ROAD NO. _____

STRAIGHT ARROW _____
 TURN ARROW 208
 STOP BAR _____
 CURBING-YELLOW _____
 WHITE _____
 HASH MARKS _____
 MISC. _____

STOP _____
 ONLY _____
 STOP AHEAD _____
 CROSSWALKS _____
 TOTAL SQ. FT. 208

DIAGRAM OF WORK

904562

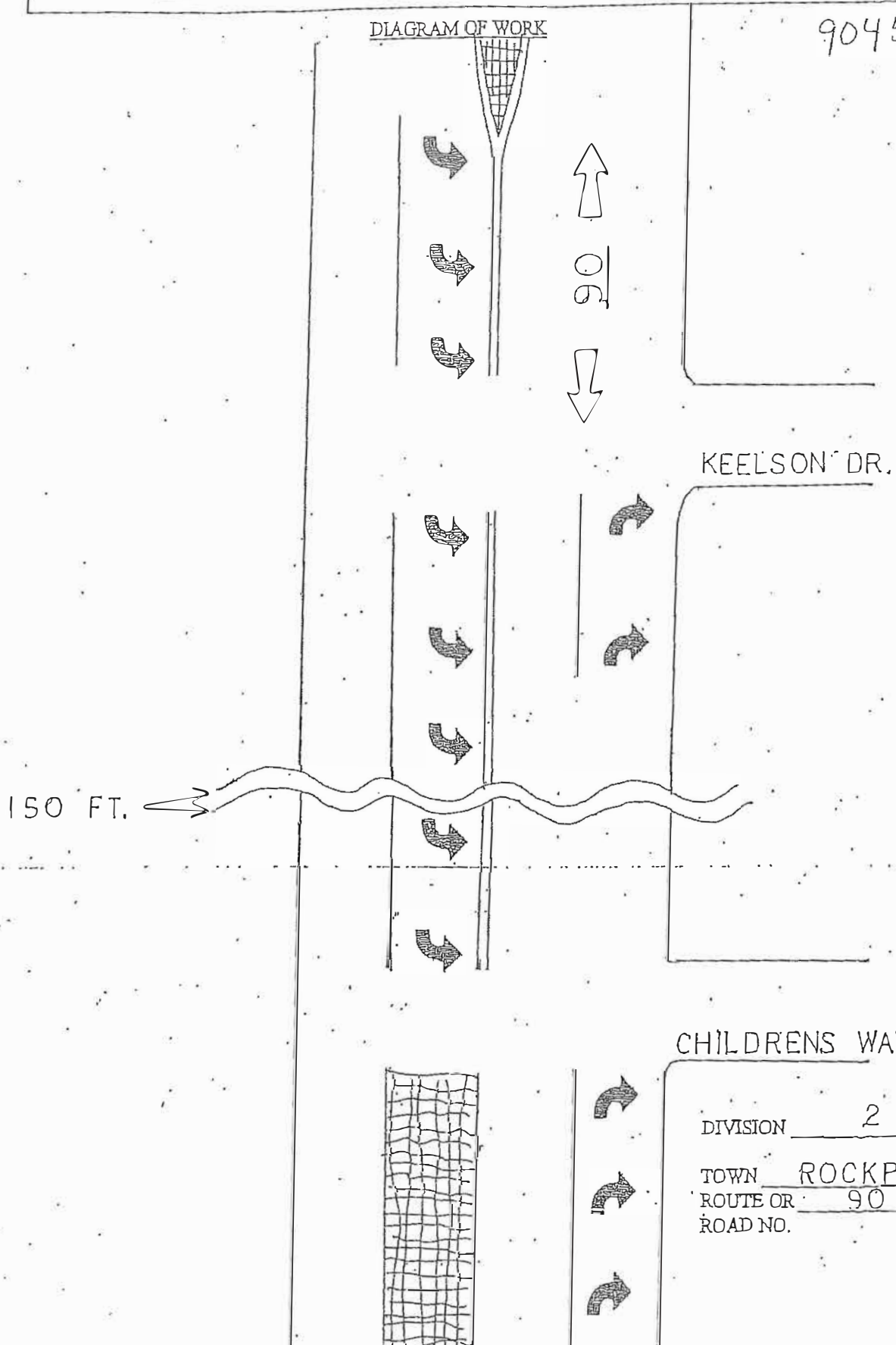

KEELSON DR.

CHILDRENS WAY

DIVISION 2
 TOWN ROCKPORT
 ROUTE OR 90
 ROAD NO.

90.4666 -

DESCRIPTION OF WORK DONE

3 WAY ARROW	123	LANE LINE	_____
TURN ARROW	112	STOP	_____
STOP BAR	238	ONLY	_____
CURBING-YELLOW	_____	STOP AHEAD	_____
WHITE	44	CROSSWALKS	_____
HASH MARKS	_____	TOTAL SQ. FT.	692
MISC. COMB ARROW	175		

DIAGRAM OF WORK

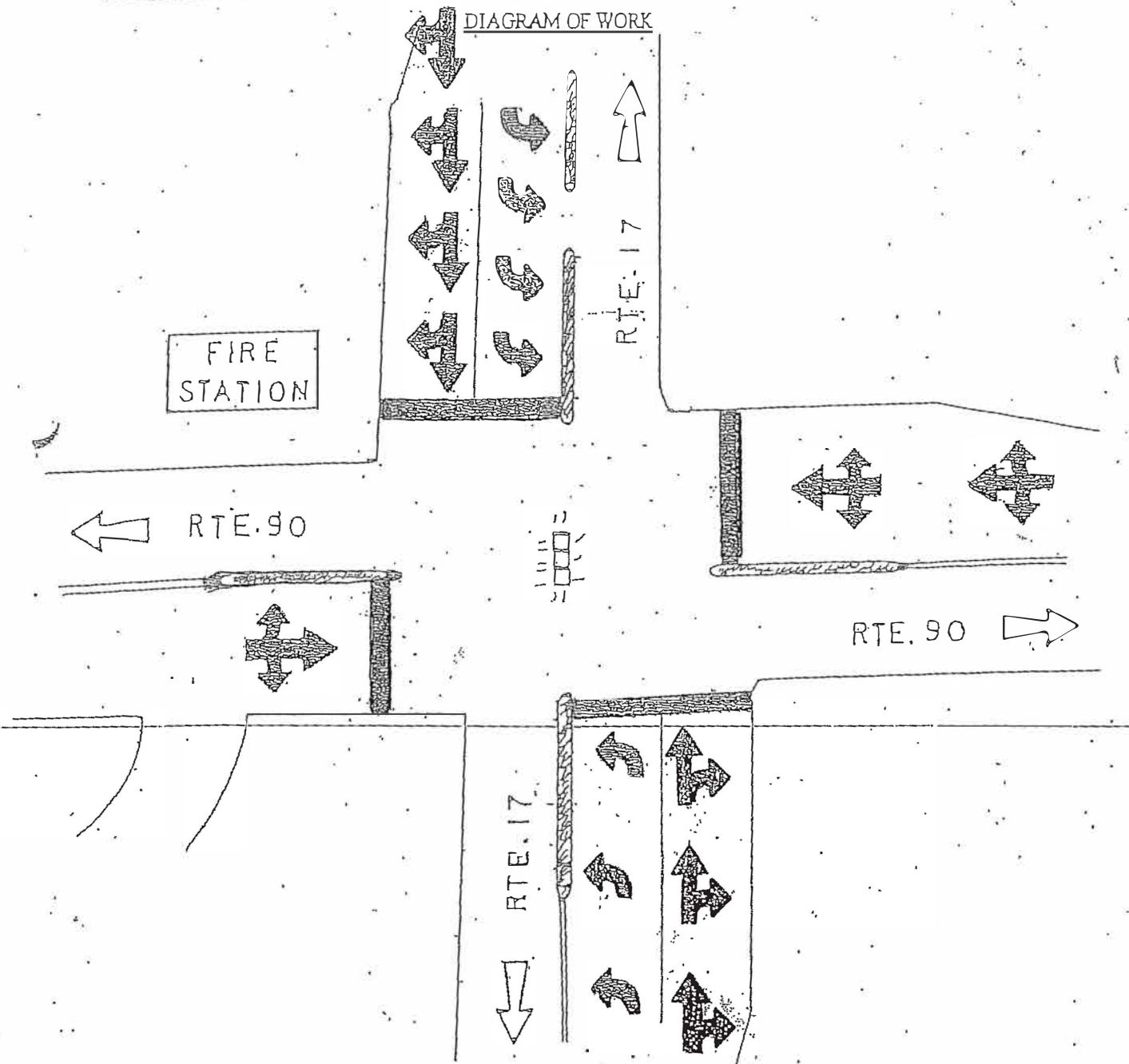

CREW LEADER _____ YES NO

PROJECT DONE BEFORE _____

DATE _____

ACTUAL JOB TIME _____

REGION 2

TOWN W. ROCKPORT

ROUTE OR 17 & 90

ROAD NO. _____

PAVEMENT MARKINGS

Project No. _____

DESCRIPTION OF WORK DONE

Rome

Asset:1053957

Total Sq. Feet: 80

Route 225 and Route 27

Stop Bar: 80

DIAGRAM OF WORK

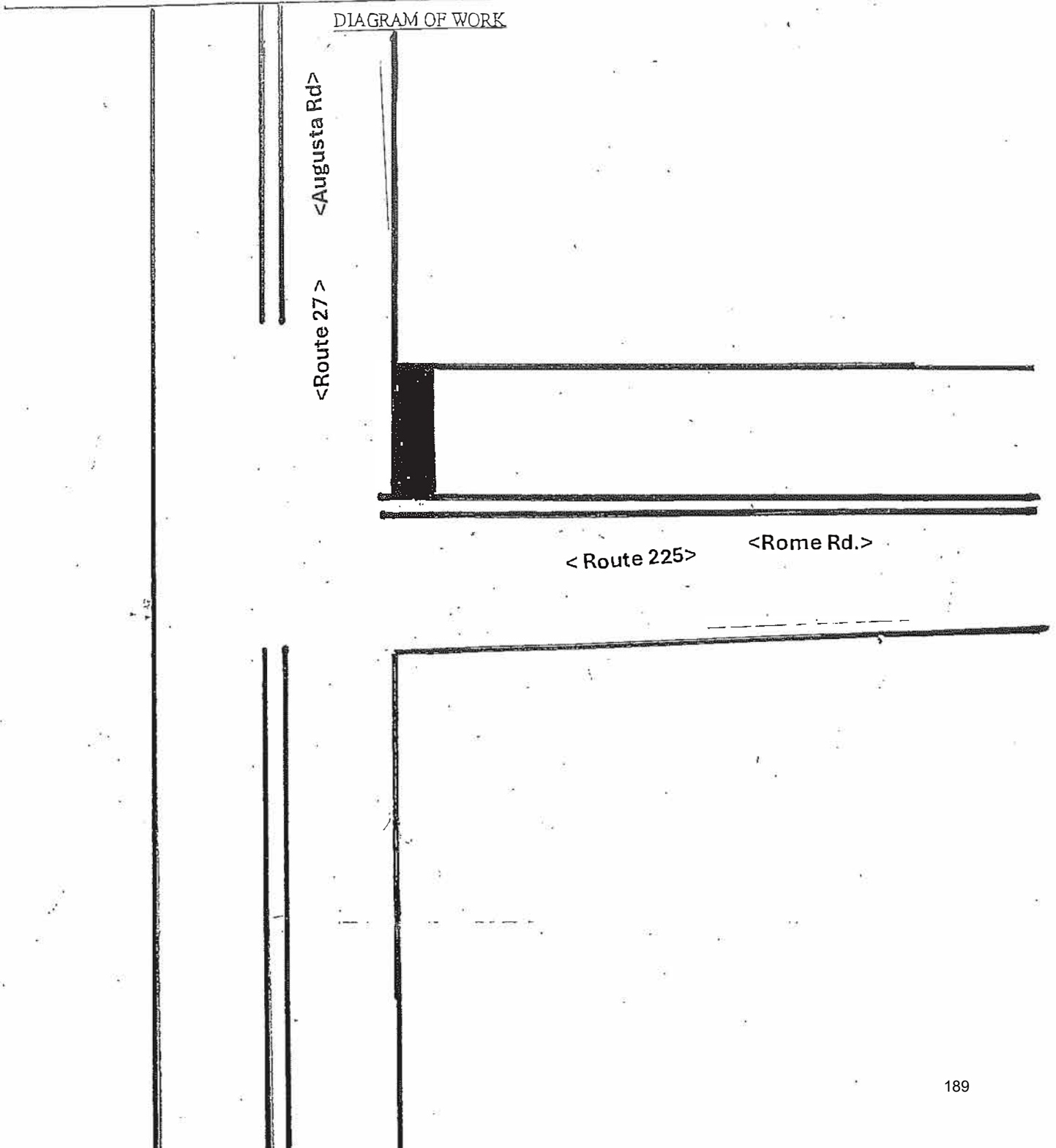

PAVEMENT MARKINGS

Project No. 904566

DESCRIPTION OF WORK DONE

STRAIGHT ARROW _____
 TURN ARROW _____
 STOP BAR 44 _____
 CURBING-YELLOW _____
 WHITE _____
 HASH MARKS _____
 MISC. _____

LANE LINE _____
 STOP 22 _____
 ONLY _____
 STOP AHEAD 37 _____
 CROSSWALKS _____
 TOTAL SQ. FT. 103 _____

DIAGRAM OF WORK

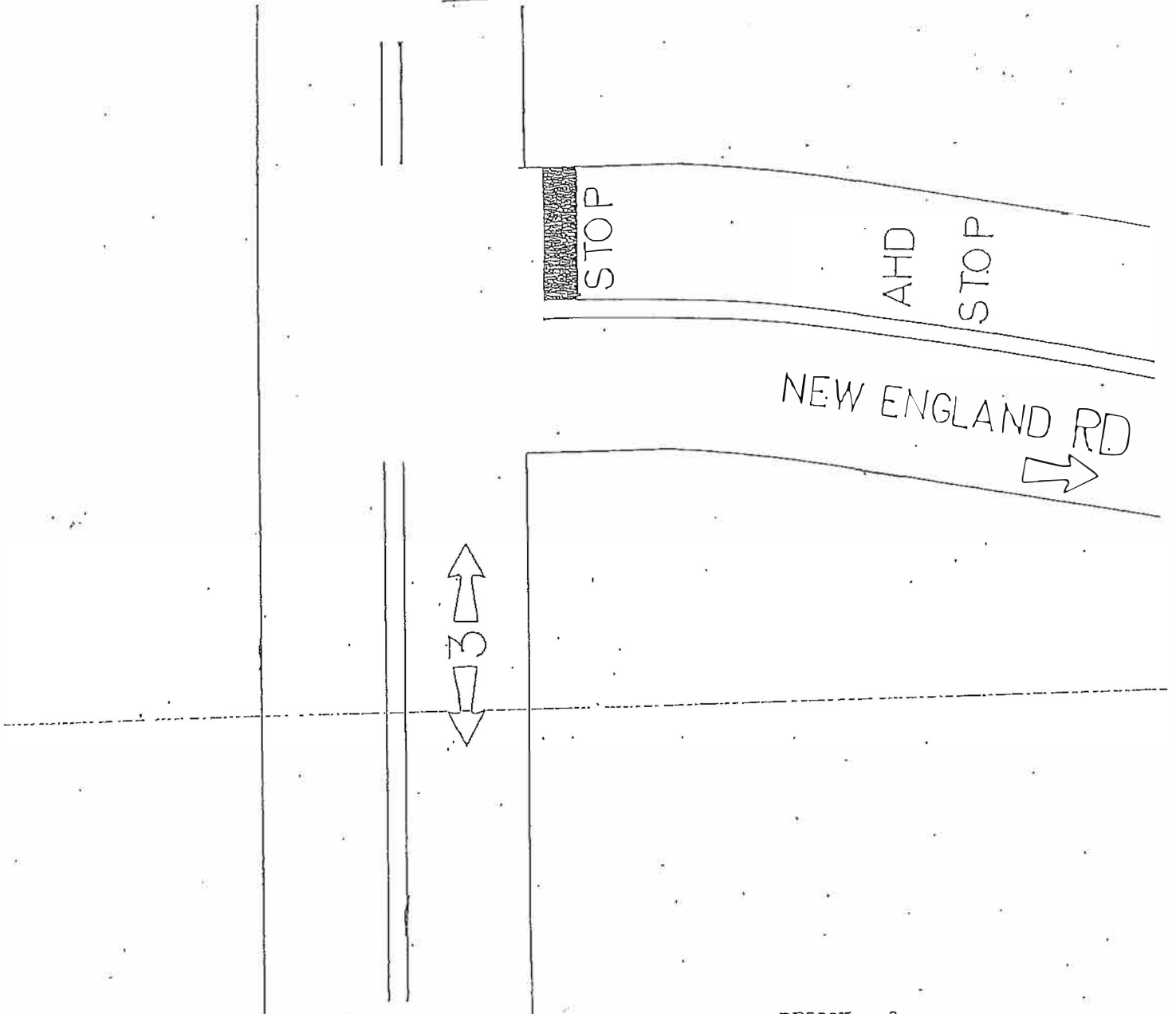

CREW LEADER _____ YES NO
 PROJECT DONE BEFORE _____
 DATE _____
 ACTUAL JOB TIME _____

REGION 2
 TOWN SEARSMONT
 ROUTE OR NEW ENGLAND RD
 ROAD NO. & RT 3

Project No. _____

904564

DESCRIPTION OF WORK DONE

STRAIGHT ARROW _____	LANE LINE _____
TURN ARROW _____	STOP _____ 22 _____
STOP BAR _____ 24 _____	ONLY _____
CURBING-YELLOW _____	STOP AHEAD _____ 37 _____
WHITE _____	CROSSWALKS _____
HASH MARKS _____	TOTAL SQ. FT. _____ 83 _____
MISC. _____	

DIAGRAM OF WORK

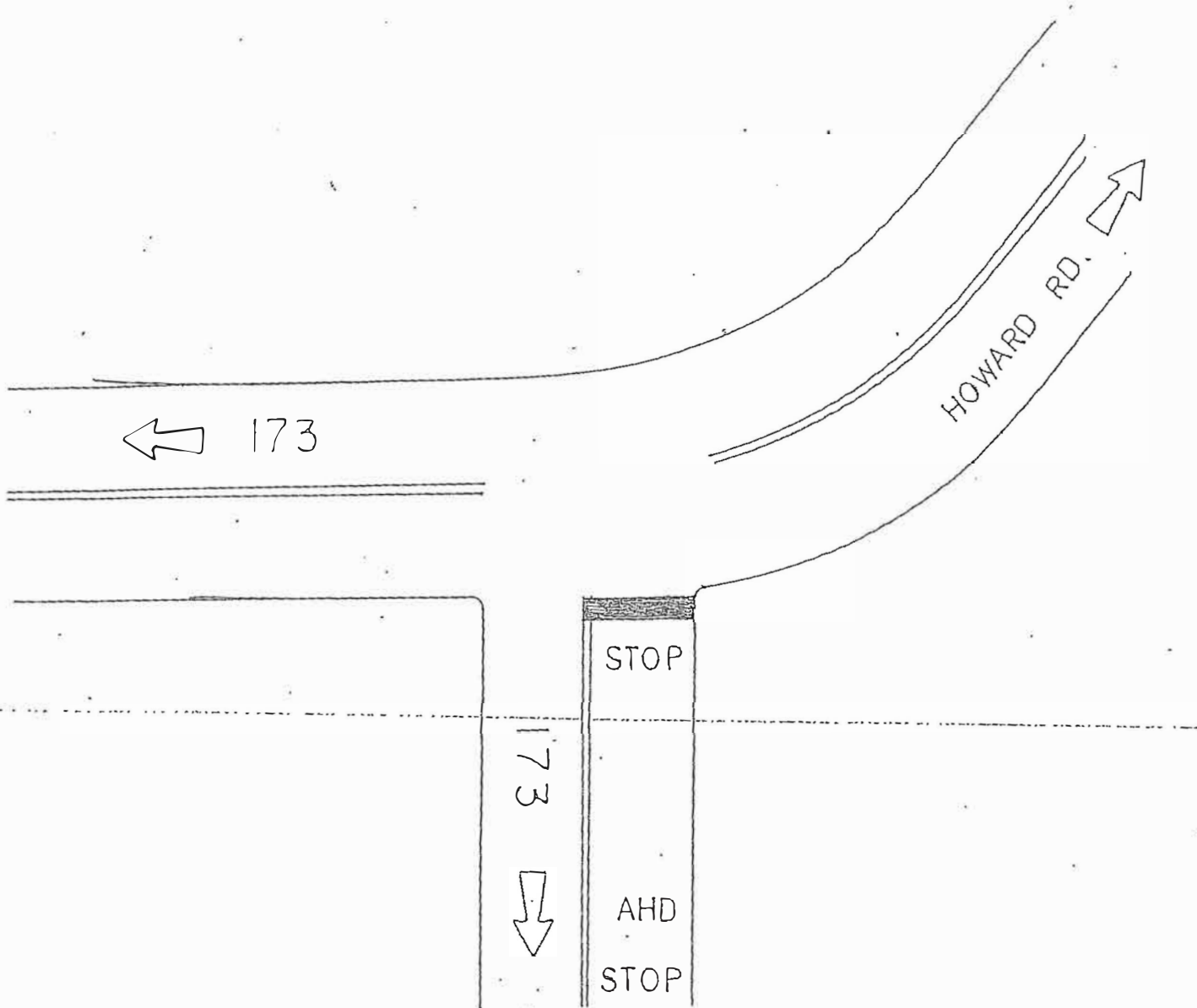

CREW LEADER _____

YES NO

PROJECT DONE BEFORE _____

DATE _____

ACTUAL JOB TIME _____

REGION 2

TOWN SEARSMONT
ROUTE OR 173 & HOWARD RD.
ROAD NO: _____

PAVEMENT MARKINGS

Project No. _____

DESCRIPTION OF WORK DONE

Smithfield

Asset: 1053959

Total Sq. Feet: 40

Route 225 +8 and Route 137

Stop Bar: 40

DIAGRAM OF WORK

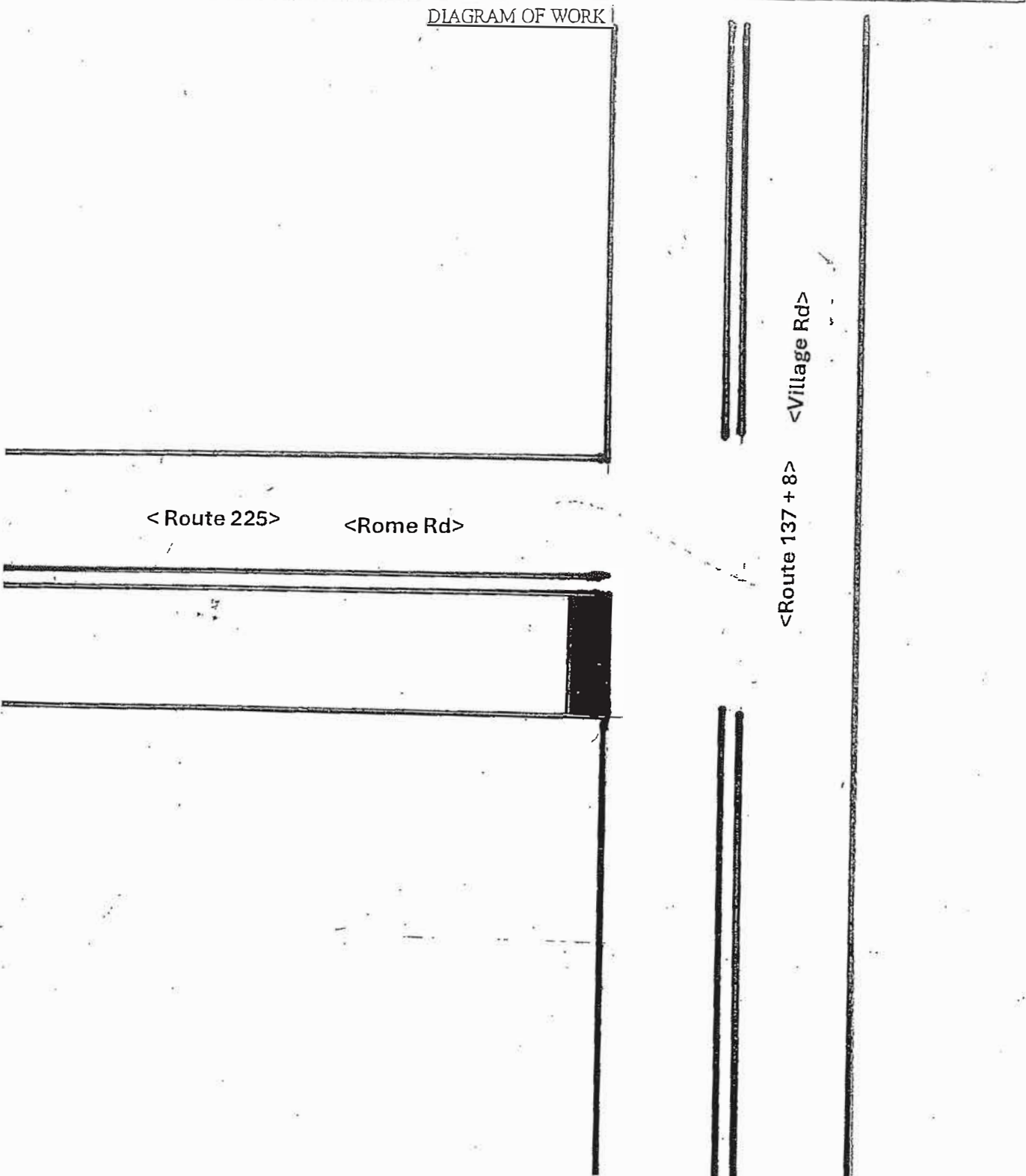

DESCRIPTION OF WORK DONE

<u>Troy</u>		<u>Asset:1080833</u>
Total Sq. Feet:	44	Route 202 and Route 220
Stop Bar:	44	

DIAGRAM OF WORK

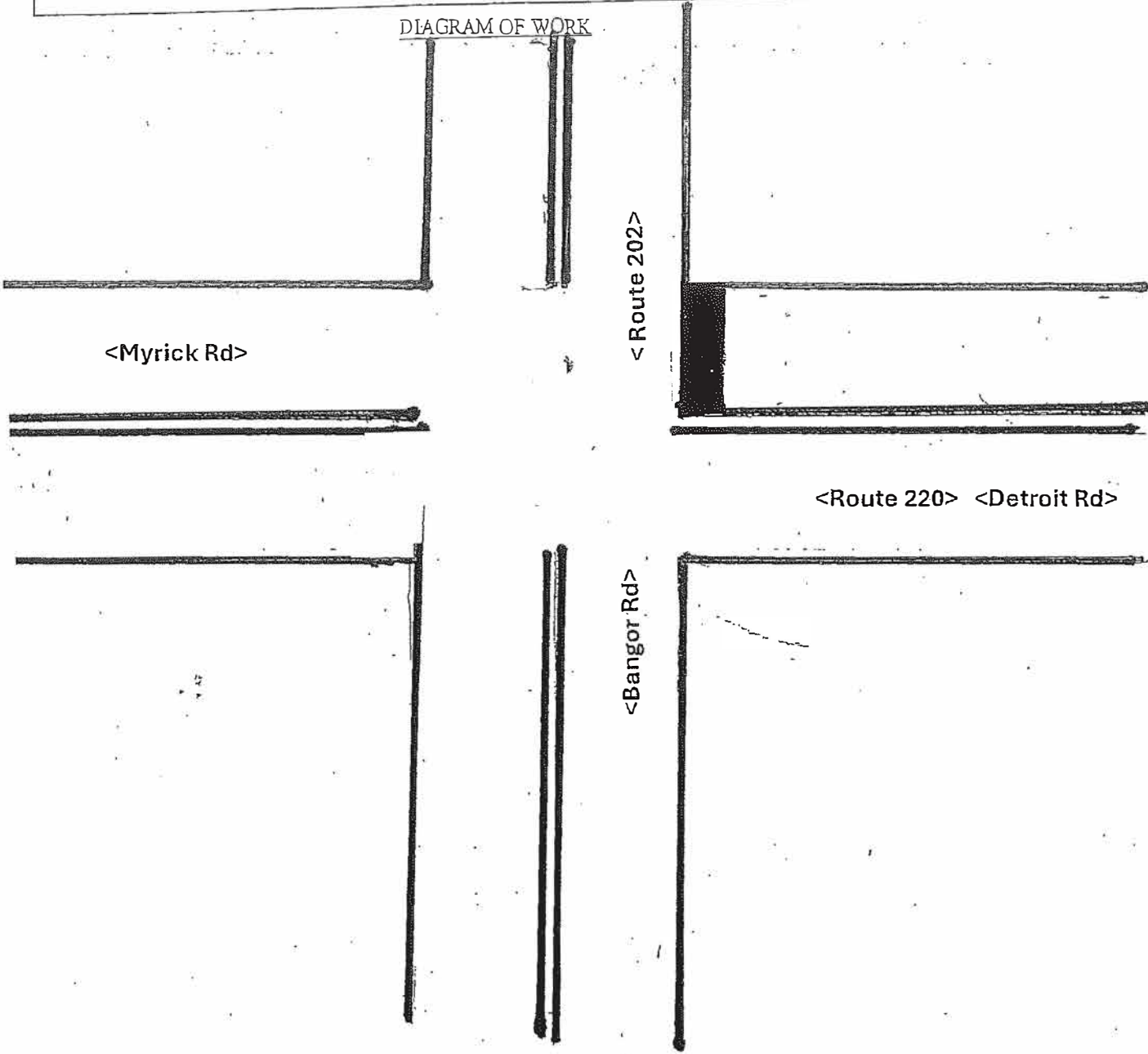

CREW LEADER _____
 YES NO
 PROJECT DONE BEFORE _____
 DATE _____
 ACTUAL JOB TIME _____

DIVISION _____
 TOWN _____
 ROUTE OR _____
 ROAD NO. _____

PAVEMENT MARKINGS

Project No. 904582

DESCRIPTION OF WORK DONE

STRAIGHT ARROW _____	LANE LINE _____
TURN ARROW _____	STOP _____ <u>22</u>
STOP BAR _____ <u>36</u>	ONLY _____
CURBING-YELLOW _____	STOP AHEAD _____ <u>37</u>
WHITE _____	CROSSWALKS _____
HASH MARKS _____	TOTAL SQ. FT. <u>95</u>
MISC. _____	

DIAGRAM OF WORK

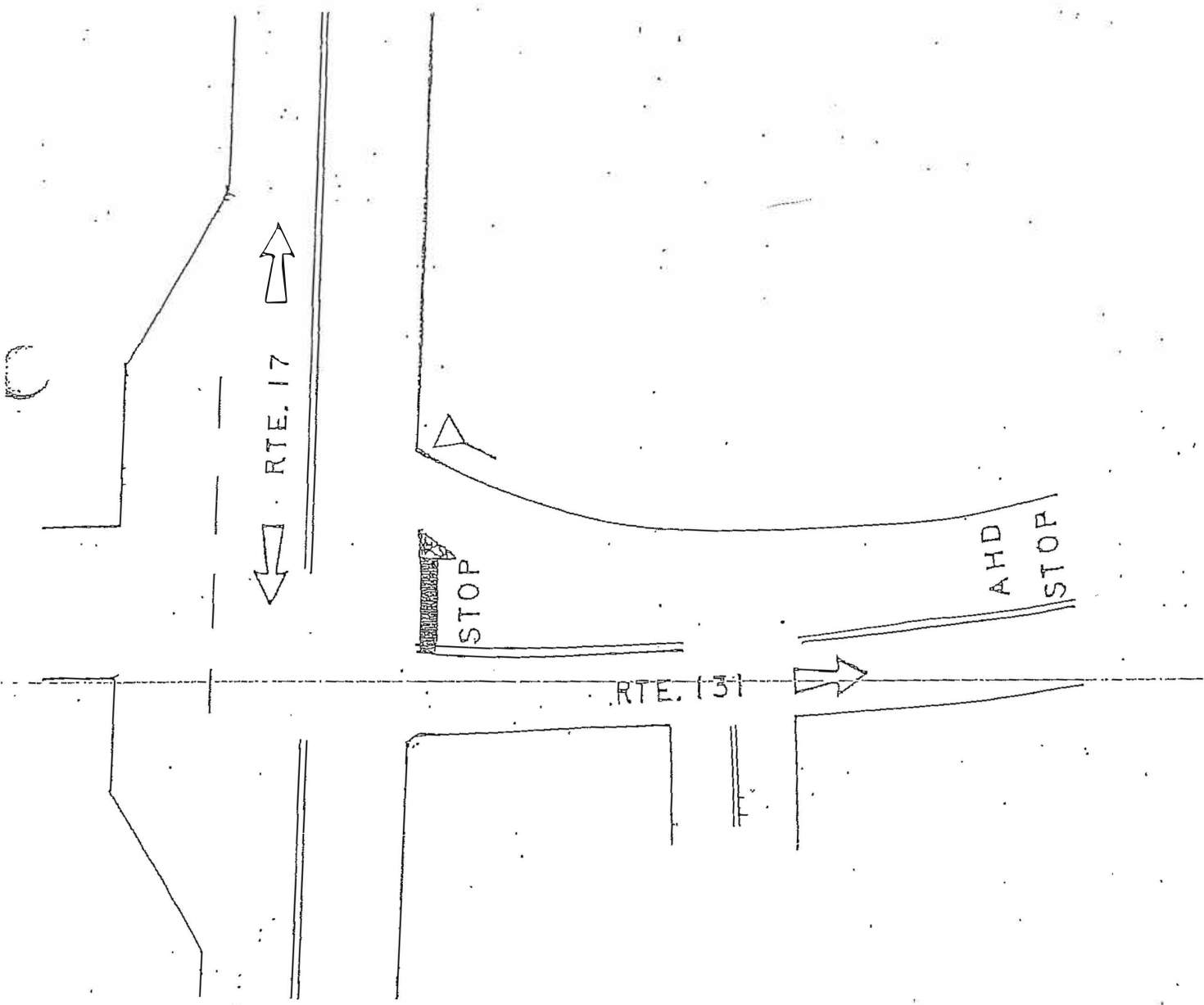

CREW LEADER _____

YES NO

PROJECT DONE BEFORE. _____

DATE _____

ACTUAL JOB TIME _____

REGION 2

TOWN UNION

ROUTE OR 17 & 131

ROAD NO. _____

PAVEMENT MARKINGS

Project No. _____

DESCRIPTION OF WORK DONE

Union

Asset: 1005965

Total Sq. Feet: 87

Stop Bar: 28

Stop: 22

Stop AHD: 37

Route 17+235

Map: 14

DIAGRAM OF WORK

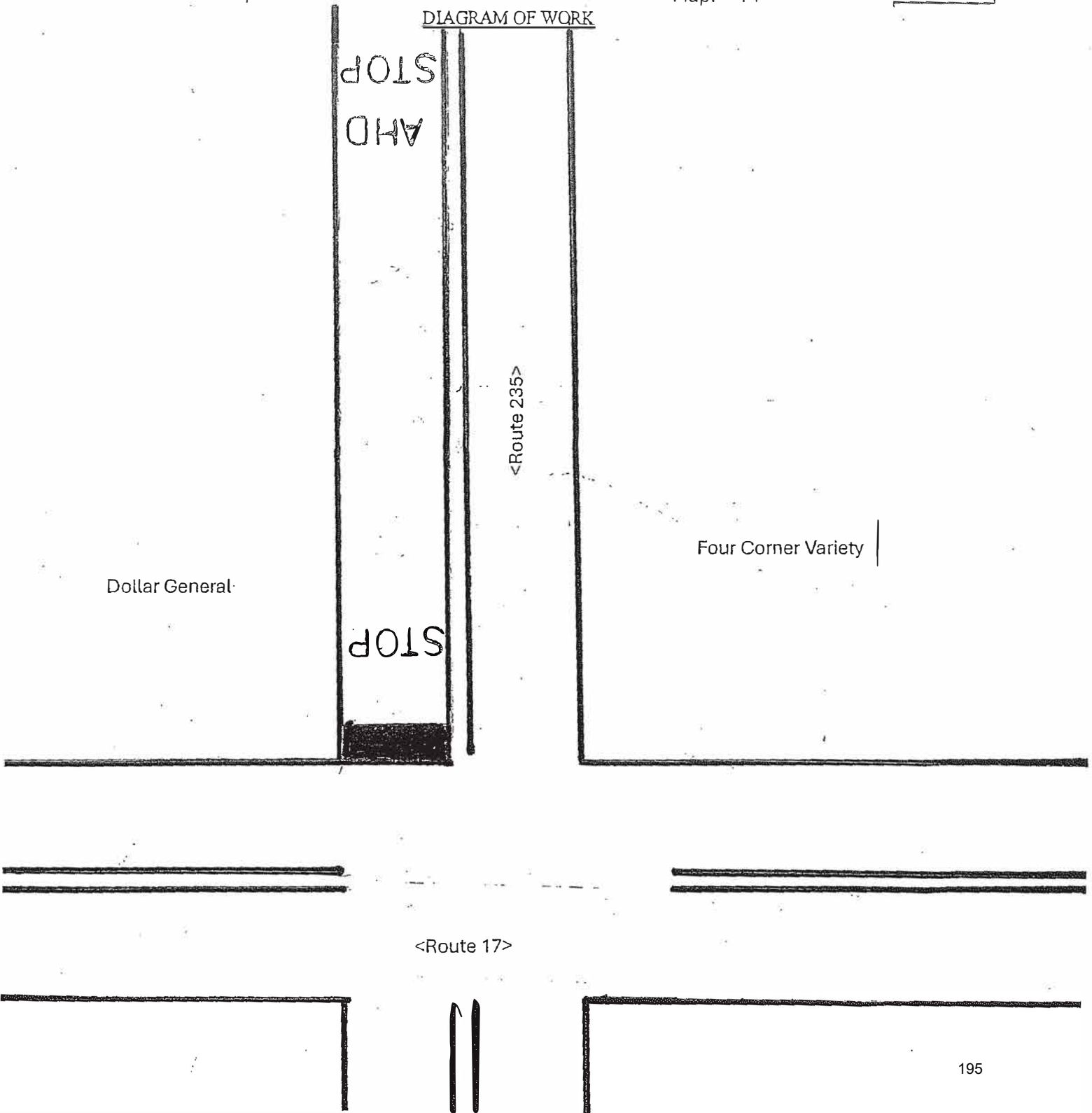

DESCRIPTION OF WORK DONE

Union _____	Asset: 1053867
Total Sq. Feet: 96	Location: Route 17+ 235
Stop Bar: 96	Stop Bar is on Buzzel Hill Rd

DIAGRAM OF WORK

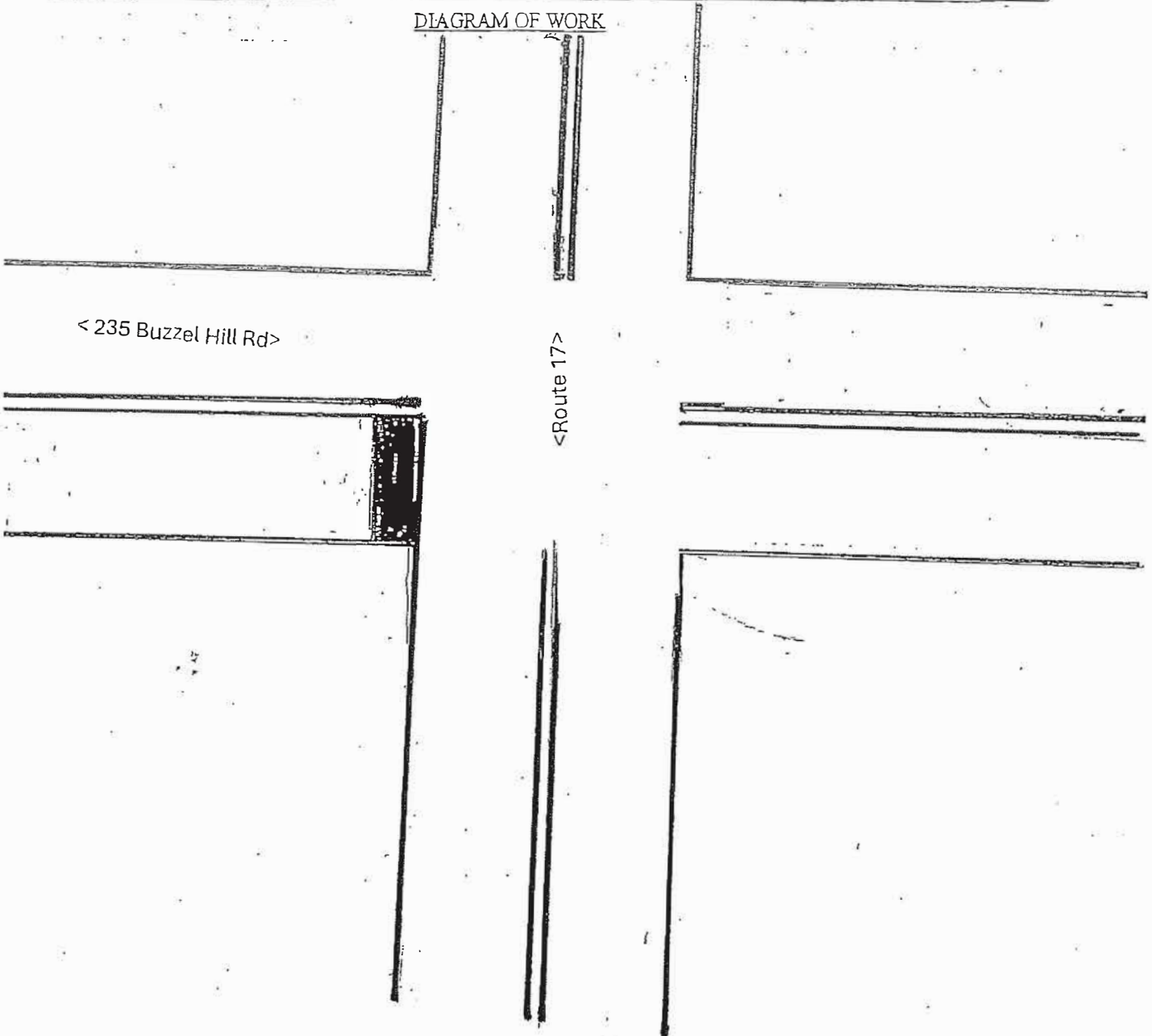

CREW LEADER _____
 YES NO
 PROJECT DONE BEFORE _____
 DATE _____
 ACTUAL JOB TIME _____

DIVISION _____
 TOWN _____
 ROUTE OR _____
 ROAD NO. _____

PAVEMENT MARKINGS

Project No. _____

DESCRIPTION OF WORK DONE

<u>Union</u>	<u>Asset: 1053869</u>
Total Sq. Feet: 50	Location: Route 131 + 17
Stop Bar: 50	Next to Maritime Store and John Deere Store

DIAGRAM OF WORK

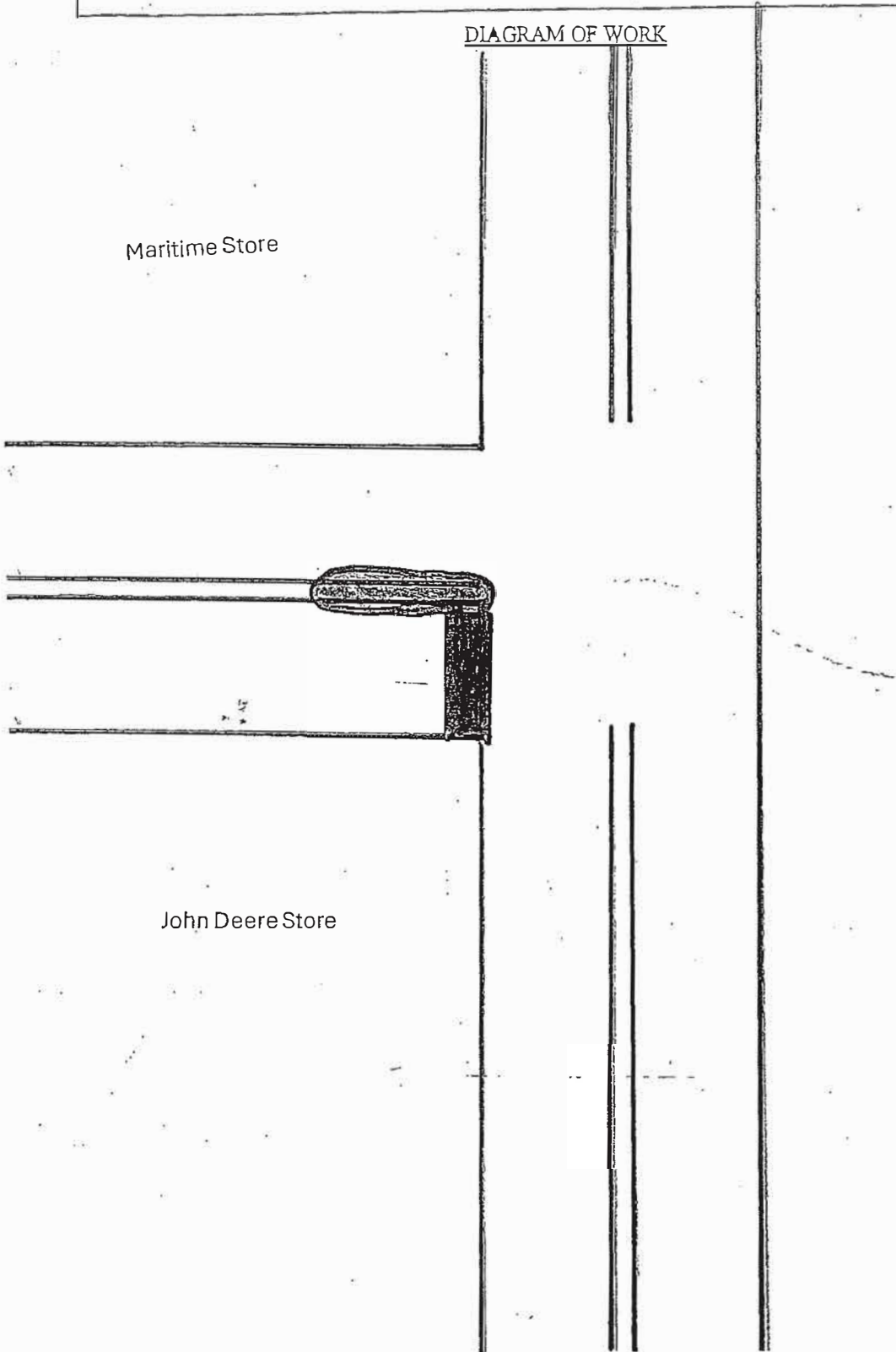

PAVEMENT MARKINGS

Project No. _____

DESCRIPTION OF WORK DONE

Unity

Asset:1080823

Total Sq. Feet: 28

Route 139 and Route 202

Stop Bar: 28

DIAGRAM OF WORK

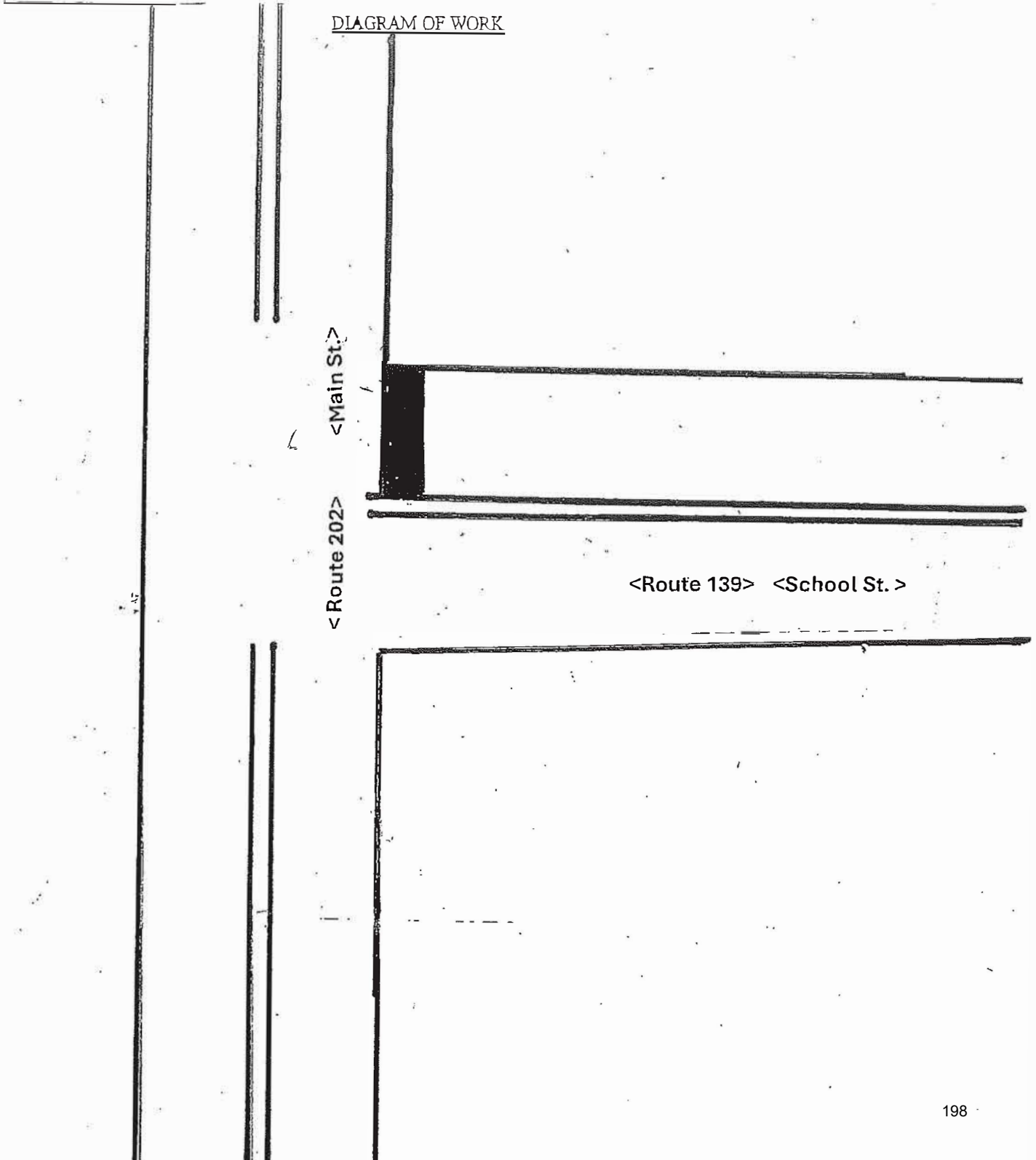

DESCRIPTION OF WORK DONE

<u>Unity</u>	Asset:1080825	
Total Sq. Feet:	88	Route 139 and Route 202
Stop Bar:	88	

DIAGRAM OF WORK

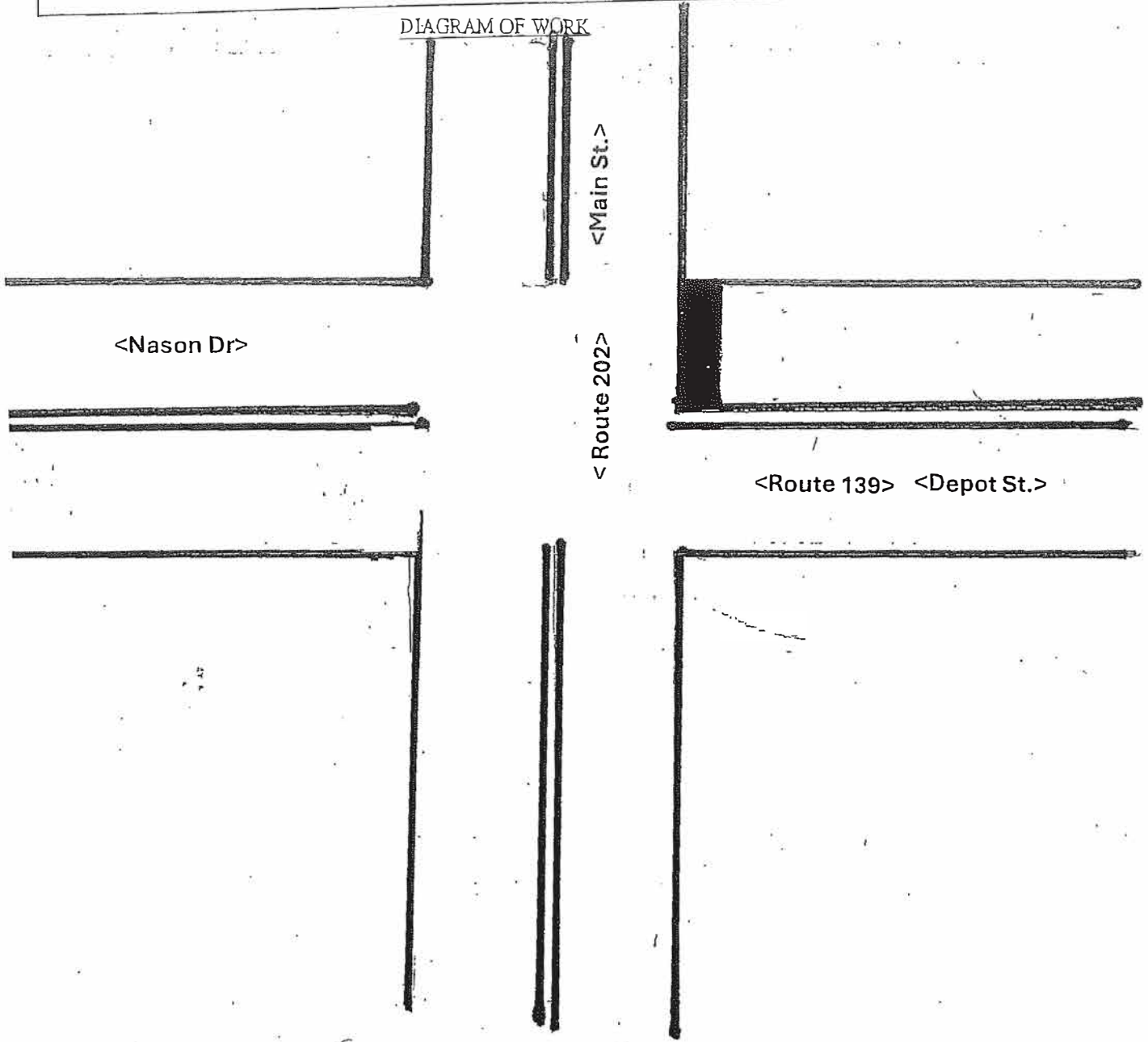

CREW LEADER _____
 YES NO
 PROJECT DONE BEFORE _____
 DATE _____
 ACTUAL JOB TIME _____

DIVISION _____
 TOWN _____
 ROUTE OR _____
 ROAD NO. _____

PAVEMENT MARKINGS

Project No. _____

DESCRIPTION OF WORK DONE

Unity

Asset: 1080827

Total Sq. Feet: 40

Route 220 and Route 202

Stop Bar: 40

DIAGRAM OF WORK

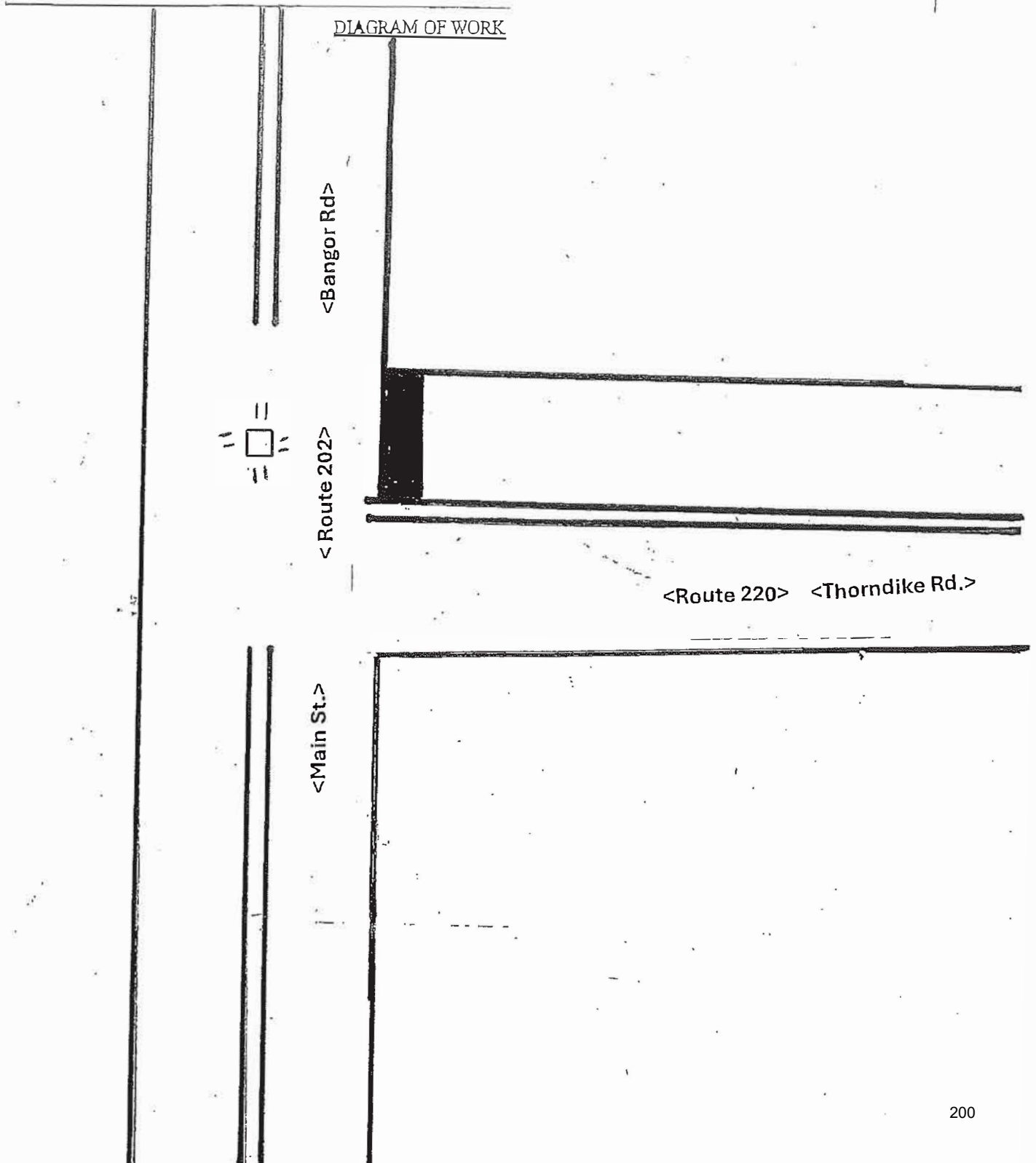

PAVEMENT MARKINGS

Project No. _____

DESCRIPTION OF WORK DONE

<u>Unity</u>		<u>Asset:1080829</u>
Total Sq. Feet:	52	Route 139 and Route 220
Stop Bar:	52	

DIAGRAM OF WORK

<Route 139> <Depot St.>

<Thorndike Rd.>

<Route 220>

PAVEMENT MARKINGS

Project No. _____

DESCRIPTION OF WORK DONE

Unity

Asset:1080831

Total Sq. Feet: 54

Route 139 and Route 220

Stop Bar: 54

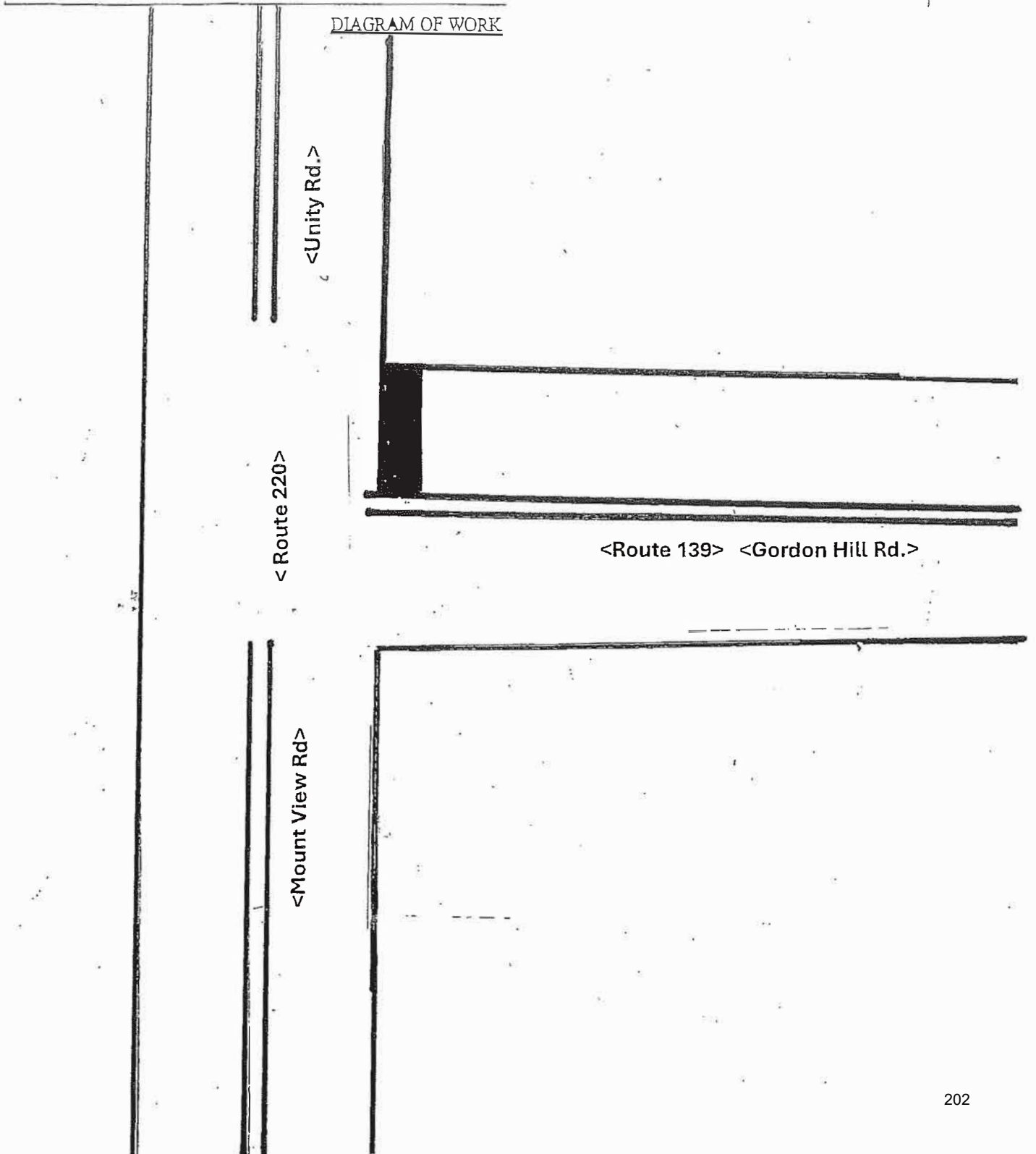

PAVEMENT MARKINGS

Project No. _____

DESCRIPTION OF WORK DONE

<u>Washington</u>		<u>Asset: 1034354</u>
Total Sq. Feet:	62	Route 126 and Route 220
Stop Bar:	62	

DIAGRAM OF WORK

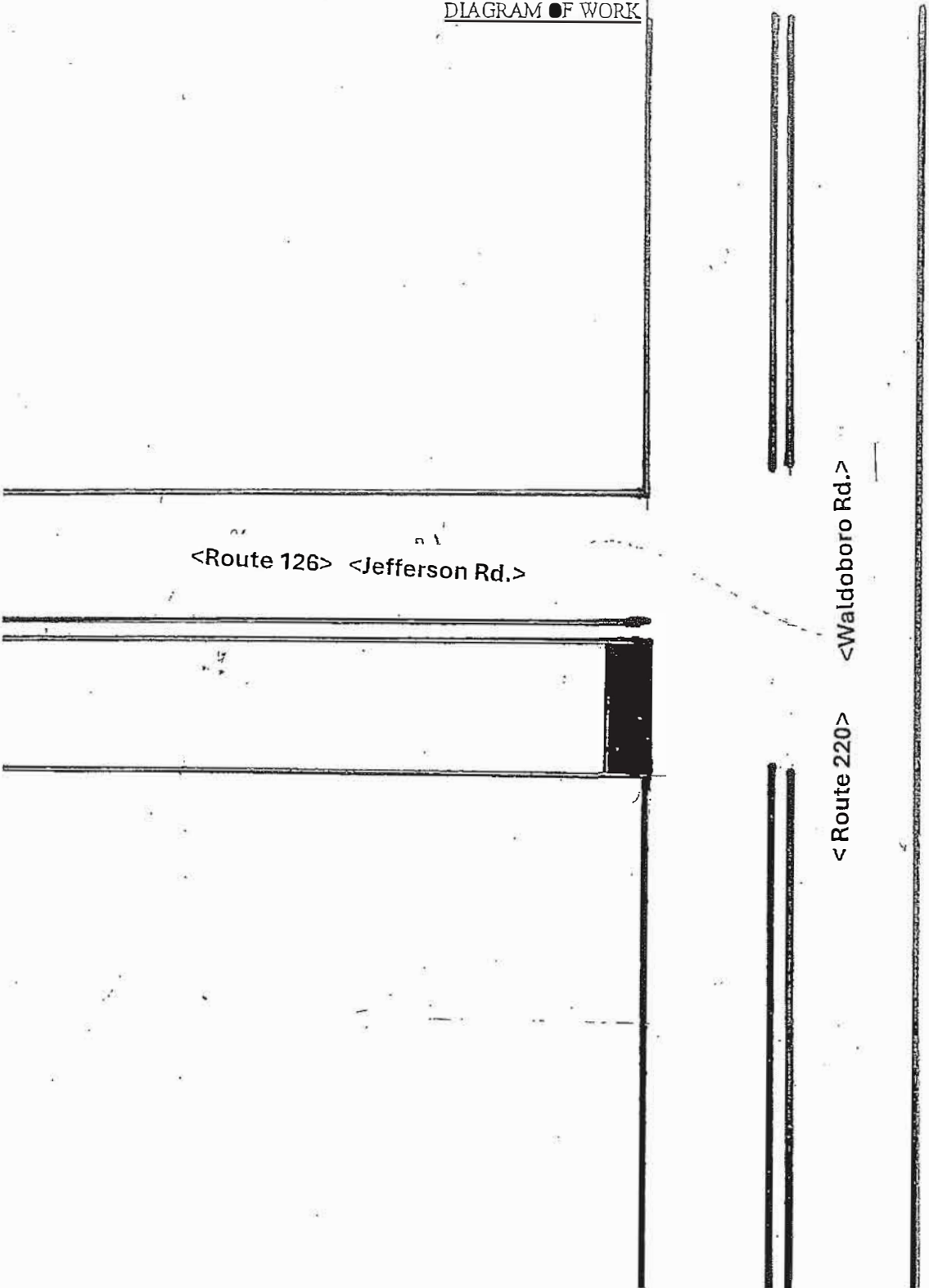

Project No. _____

DESCRIPTION OF WORK DONE

<u>Washington</u>		Asset:1052295
Total Sq. Feet:	26	Route 17 and Route 206
Stop Bar:	26	

DIAGRAM OF WORK

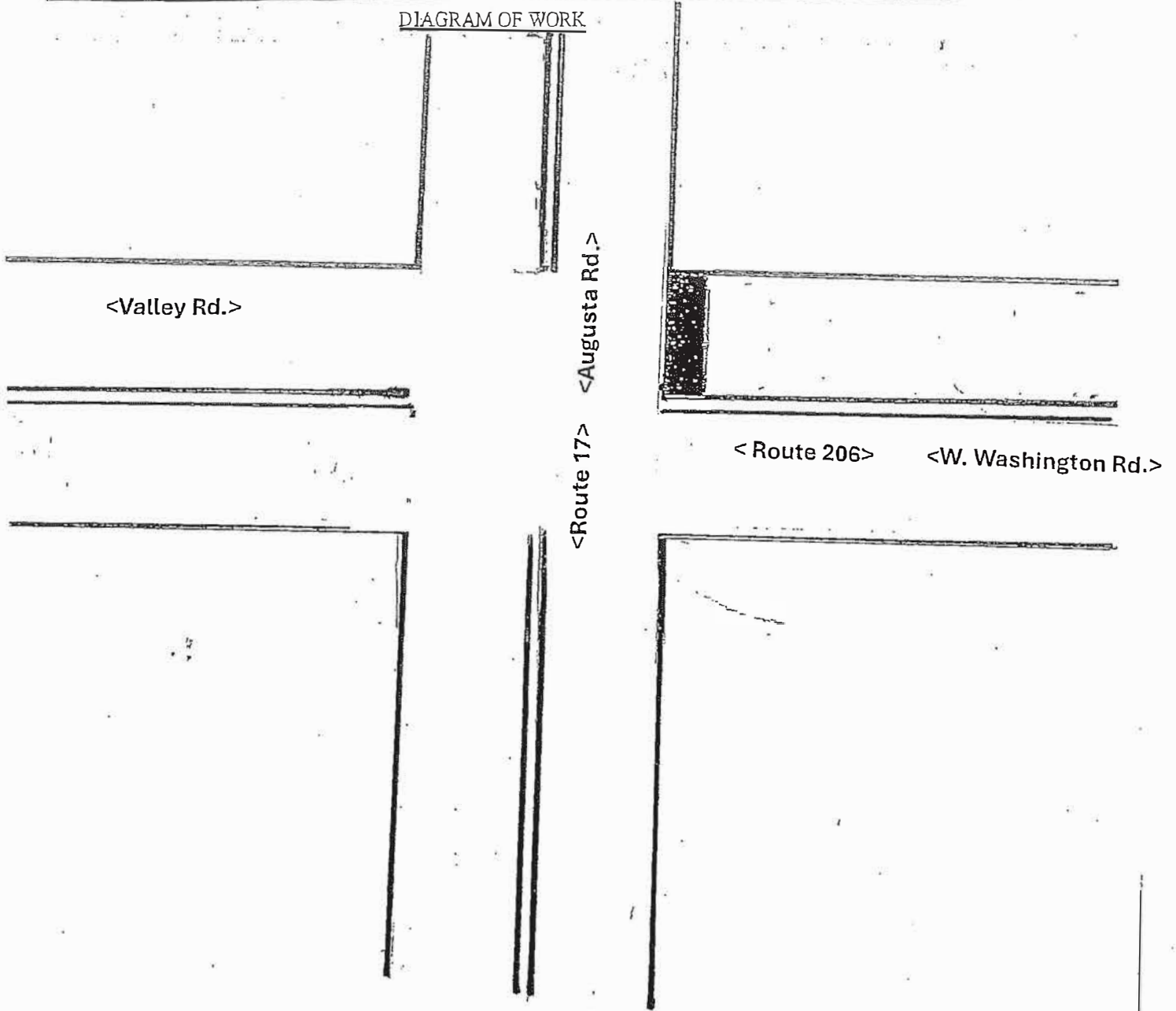

CREW LEADER _____
 YES NO
 PROJECT DONE BEFORE _____
 DATE _____
 ACTUAL JOB TIME _____

DIVISION _____
 TOWN _____
 ROUTE OR _____
 ROAD NO. _____

PAVEMENT MARKINGS

Project No. _____

DESCRIPTION OF WORK DONE

<u>Washington</u>		Asset:1052297
Total Sq. Feet:	44	Route 105 and Route 206
Stop Bar:	44	

DIAGRAM OF WORK

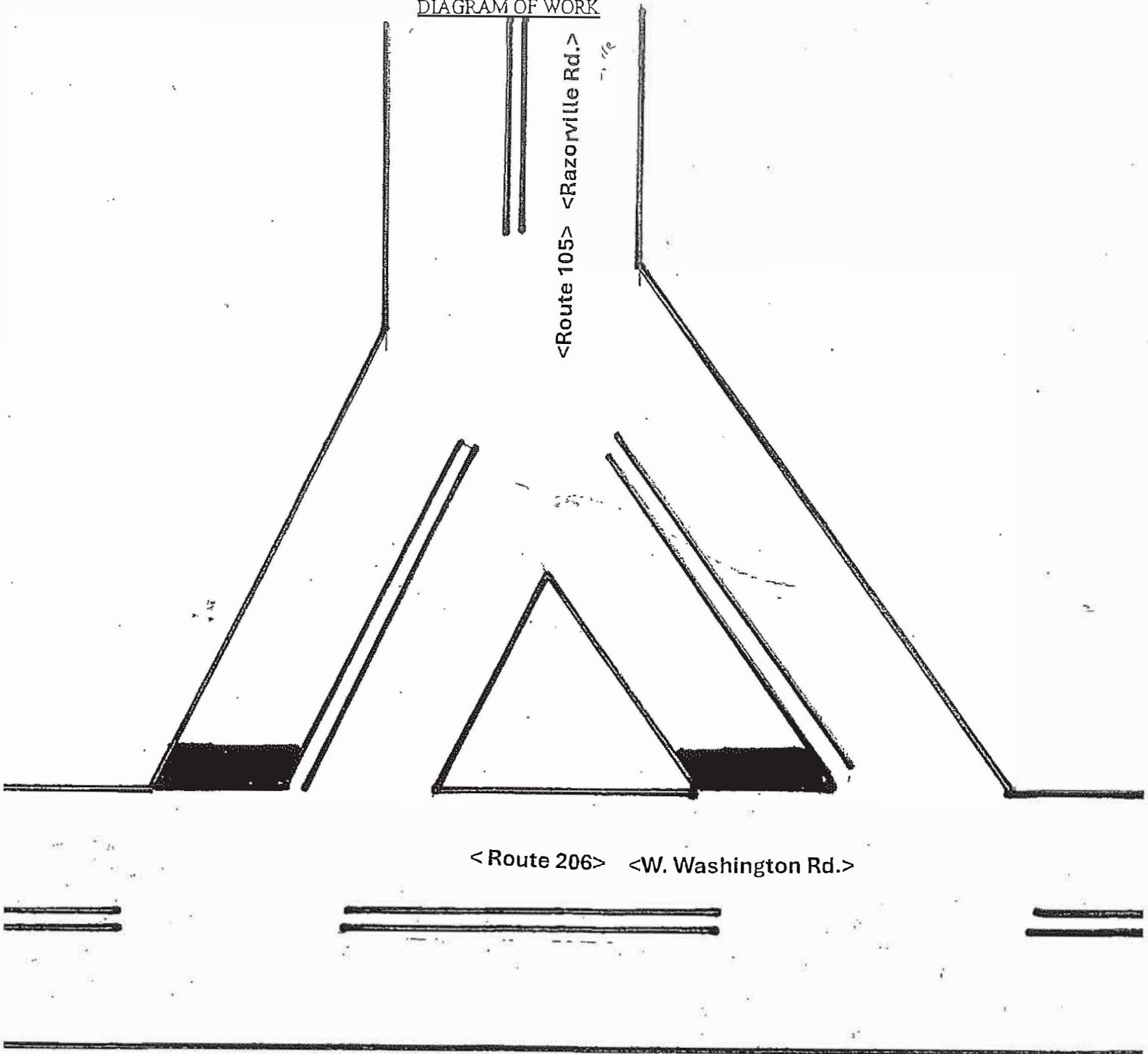

PAVEMENT MARKINGS

Project No. _____

DESCRIPTION OF WORK DONE

Washington	/	Asset:1052299
Total Sq. Feet:	86	Route 105 and Route 206
Stop Bar:	86	

DIAGRAM OF WORK

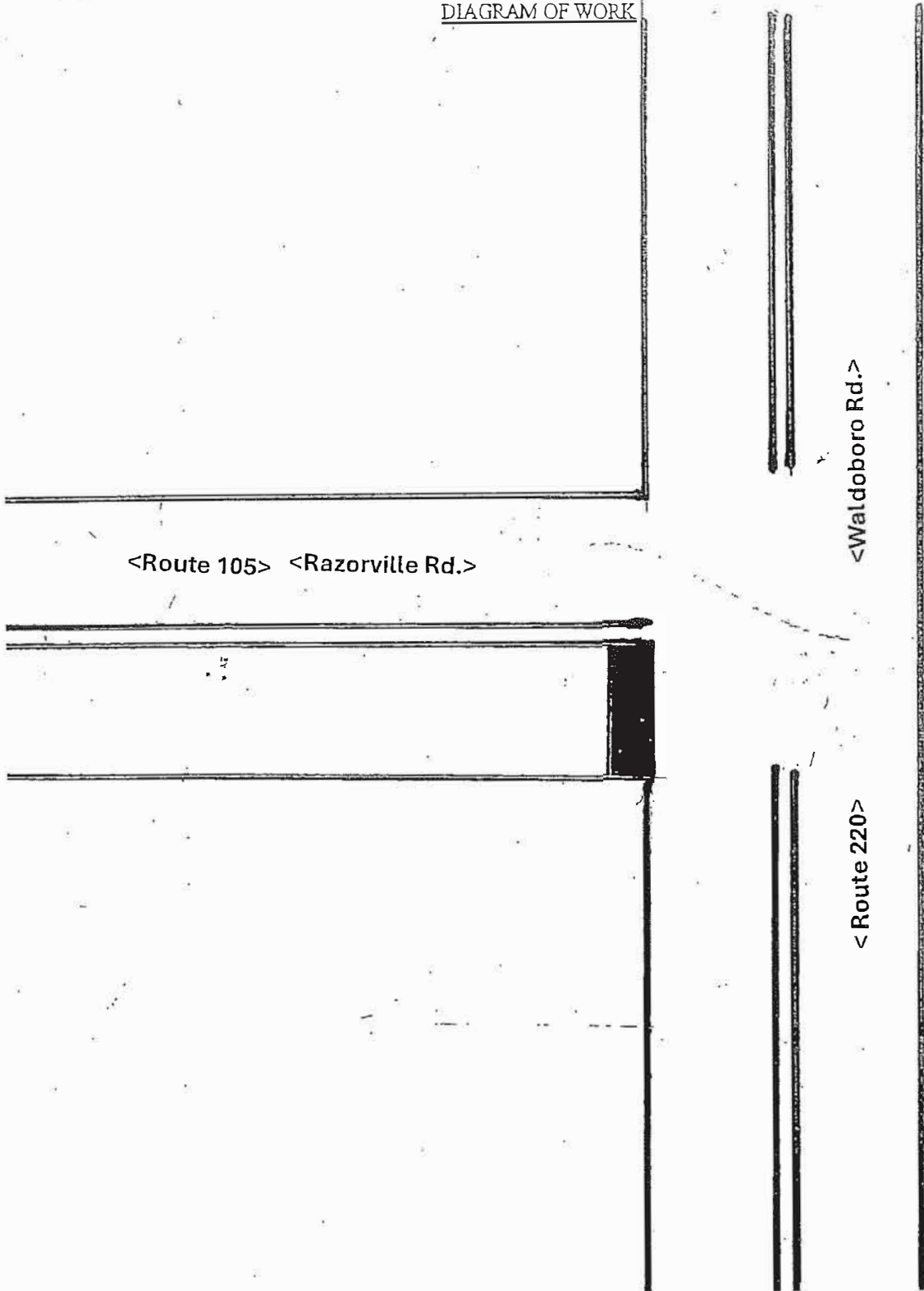

DESCRIPTION OF WORK DONE

<u>Washington</u>	Asset:1052301
Total Sq. Feet: 120	Route 17 and Route 220
Stop Bar: 120	

DIAGRAM OF WORK

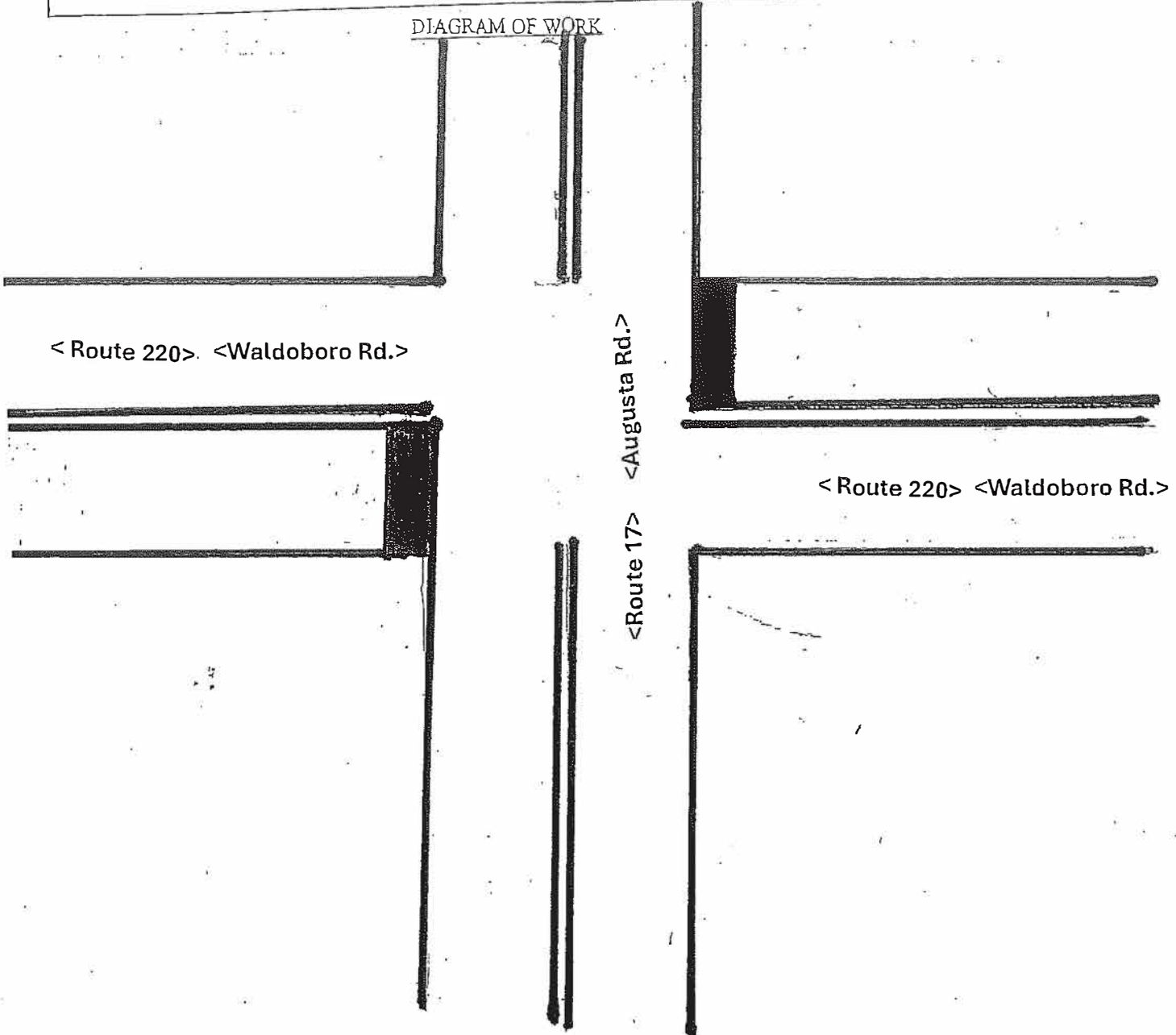

CREW LEADER _____
 YES NO
 PROJECT DONE BEFORE _____
 DATE _____
 ACTUAL JOB TIME _____

DIVISION _____
 TOWN _____
 ROUTE OR _____
 ROAD NO. _____

PAVEMENT MARKINGS

Project No. 904595

DESCRIPTION OF WORK DONE

STRAIGHT ARROW _____	LANE LINE _____
TURN ARROW _____	STOP _____
STOP BAR <u>96</u>	ONLY _____
CURBING-YELLOW _____	STOP AHEAD <u>37</u>
WHITE <u>12</u>	CROSSWALKS _____
HASH MARKS _____	TOTAL SQ. FT. <u>145</u>
MISC. _____	

DIAGRAM OF WORK

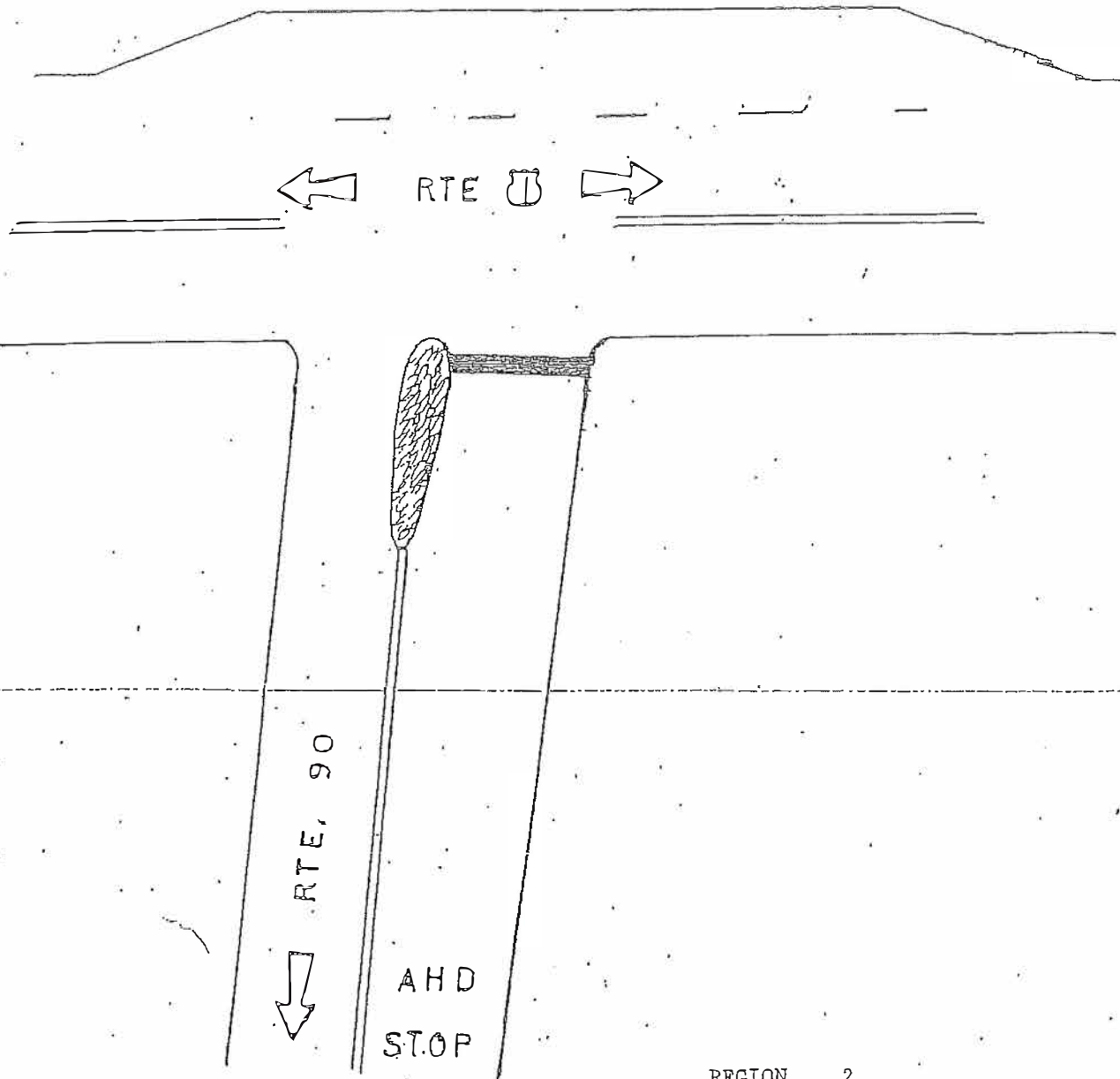

CREW LEADER _____ YES NO

PROJECT DONE BEFORE _____ DATE _____

ACTUAL JOB TIME _____

REGION 2

TOWN WARREN
ROUTE OR US 1 & 90
ROAD NO. _____

PAVEMENT MARKINGS

Project No. 904597

DESCRIPTION OF WORK DONE

STRAIGHT ARROW	_____	LANE LINE	_____
TURN ARROW	<u>64</u>	STOP	_____
STOP BAR	<u>402</u>	ONLY	_____
CURBING-YELLOW	_____	STOP AHEAD	_____
WHITE	_____	CROSSWALKS	<u>240</u>
HASH MARKS	<u>250</u>	TOTAL SQ. FT.	<u>956</u>
MISC.	_____		

DIAGRAM OF WORK

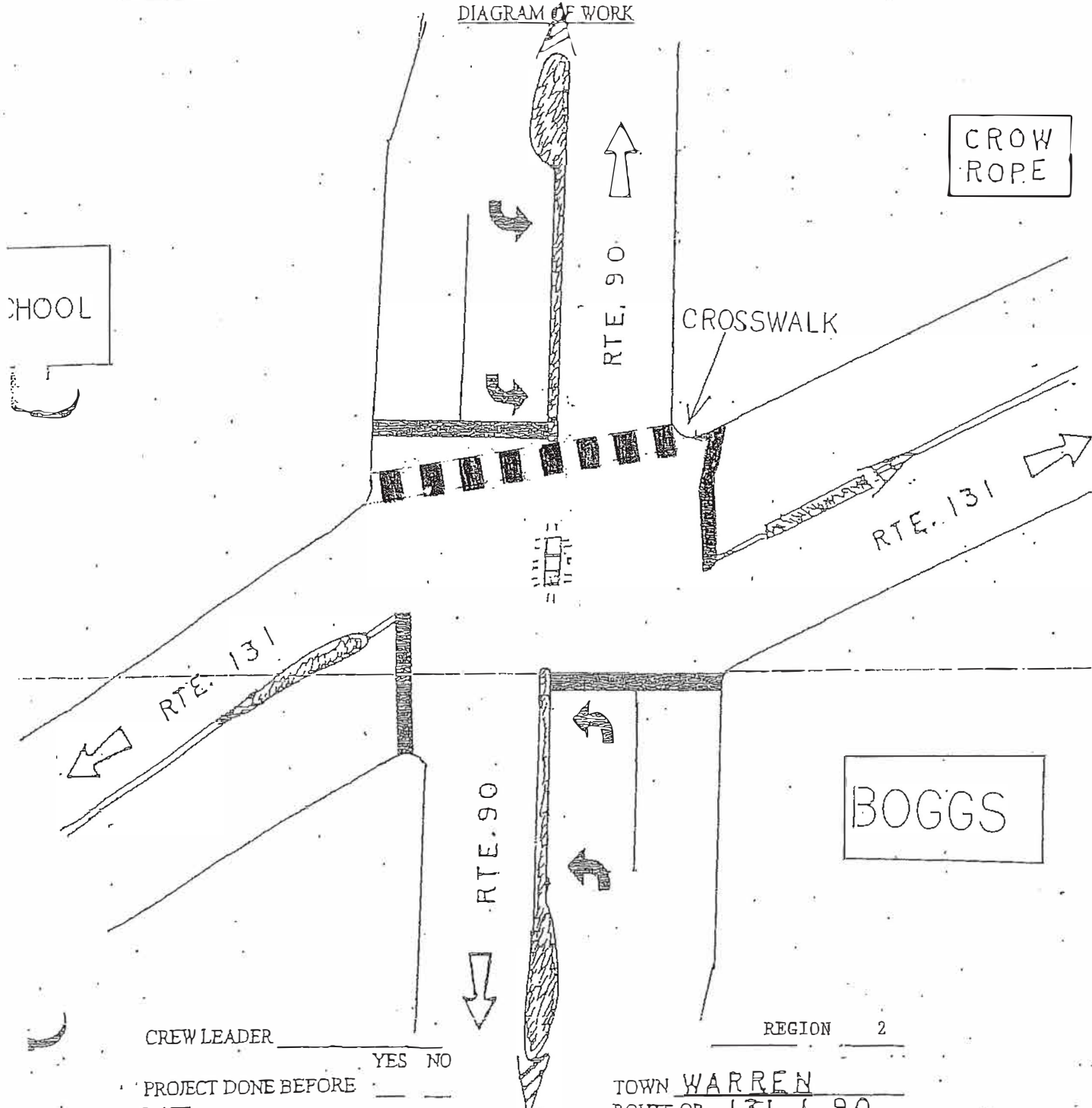

CREW LEADER _____ YES NO

PROJECT DONE BEFORE _____

DATE _____

ACTUAL JOB TIME _____

REGION 2

TOWN WARREN

ROUTE OR 131 & 90

ROAD NO. _____

904601

PAYEMENT MARKINGS

Project No. _____

904601

DESCRIPTION OF WORK DONE.

STRAIGHT ARROW _____	LANE LINE _____
TURN ARROW _____	STOP _____
STOP BAR _____ 60 _____	ONLY _____
CURBING-YELLOW _____	STOP AHEAD _____ 37 _____
WHITE _____	CROSSWALKS _____
HASH MARKS _____	TOTAL SQ. FT. _____ 97 _____
MISC. _____	

DIAGRAM OF WORK

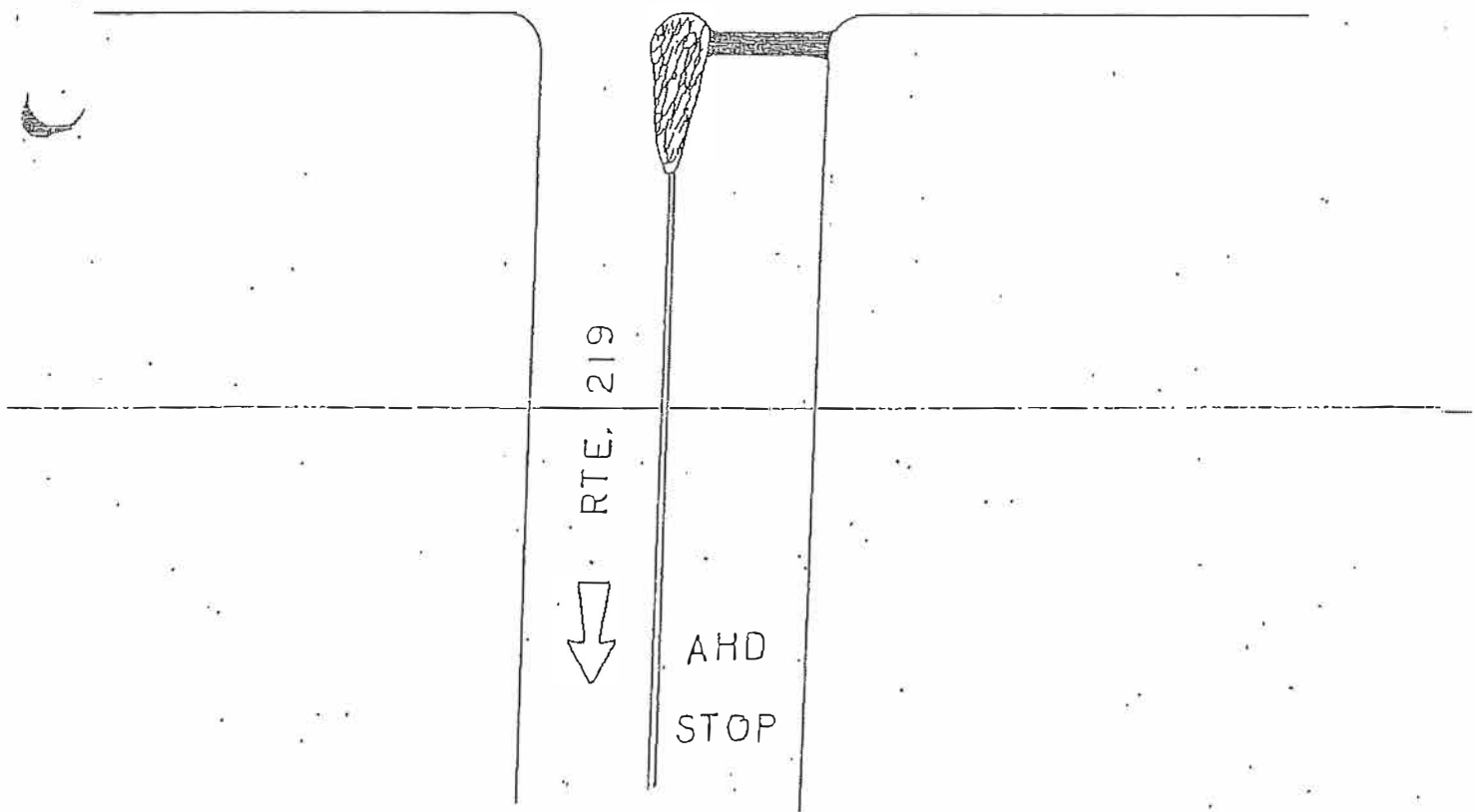
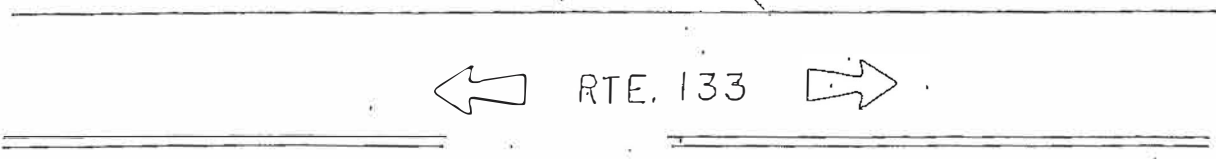

CREW LEADER _____ YES NO

PROJECT DONE BEFORE _____

1 REGION 2

TOWN WAYNE
ROUTE OR 219 & 133

DESCRIPTION OF WORK DONE

<u>Whitefield</u>		<u>Asset:1052291</u>
Total Sq. Feet:	38	Route 17 and Route 220
Stop Bar:	38	

DIAGRAM OF WORK

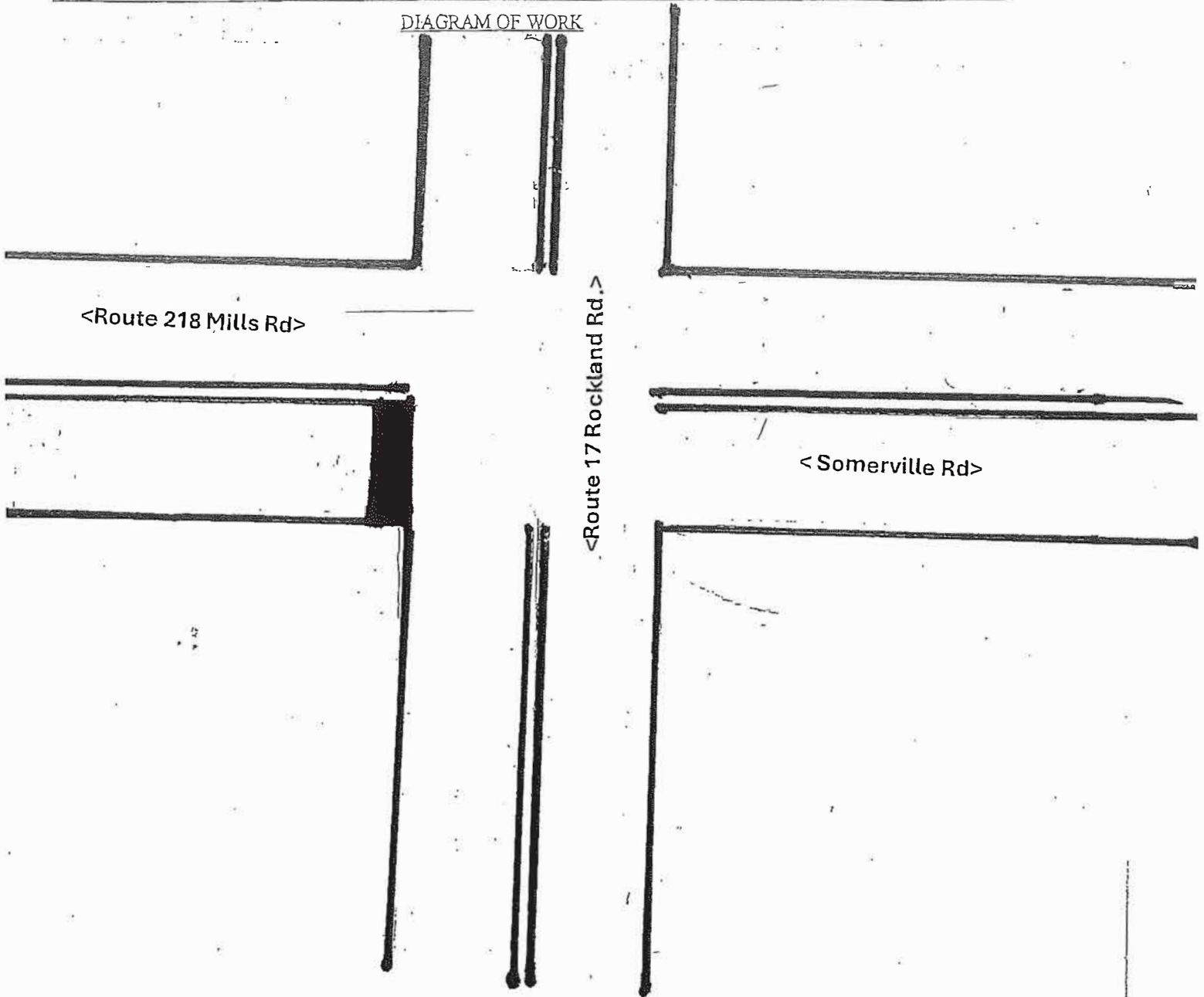

CREW LEADER _____
 YES NO
 PROJECT DONE BEFORE _____
 DATE _____
 ACTUAL JOB TIME _____

DIVISION _____
 TOWN _____
 ROUTE OR _____
 ROAD NO. _____

PAVEMENT MARKINGS

Project No. _____

DESCRIPTION OF WORK DONE

Whitefield

Asset:1052293

Total Sq. Feet: 78

Route 126 and Route 218

Stop Bar: 78

DIAGRAM OF WORK

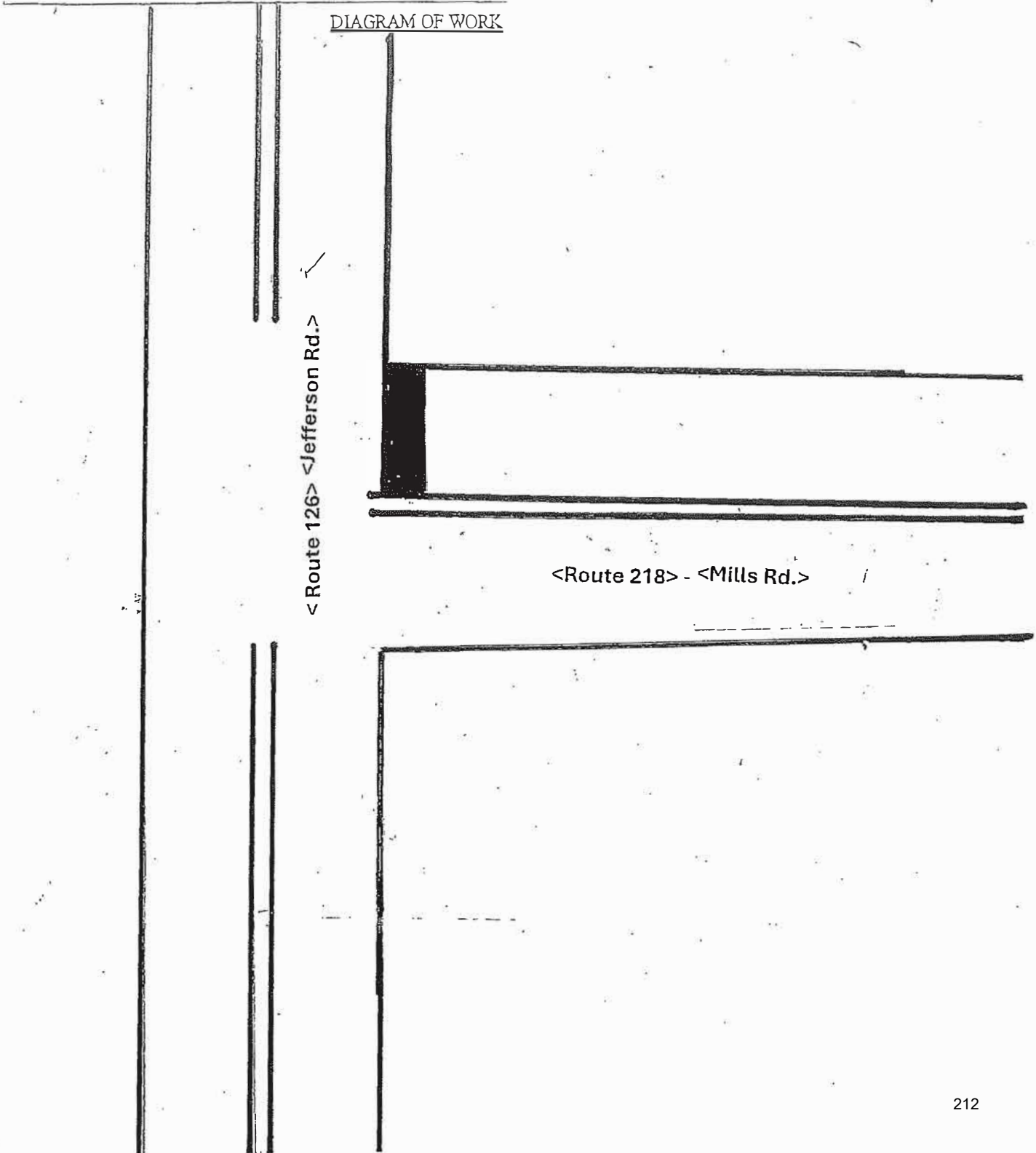

PAVEMENT MARKINGS

Project No. _____

904608

DESCRIPTION OF WORK DONE

STRAIGHT ARROW _____	LANE LINE _____
TURN ARROW <u>80</u>	STOP ONLY <u>22</u>
STOP BAR <u>36</u>	STOP <u>AHD</u> <u>39</u>
CURBING-YELLOW _____	CROSSWALKS _____
WHITE _____	
HASH MARKS _____	TOTAL SQ. FT. <u>302</u>
MISC. <u>125 COMBOS</u>	

DIAGRAM OF WORK

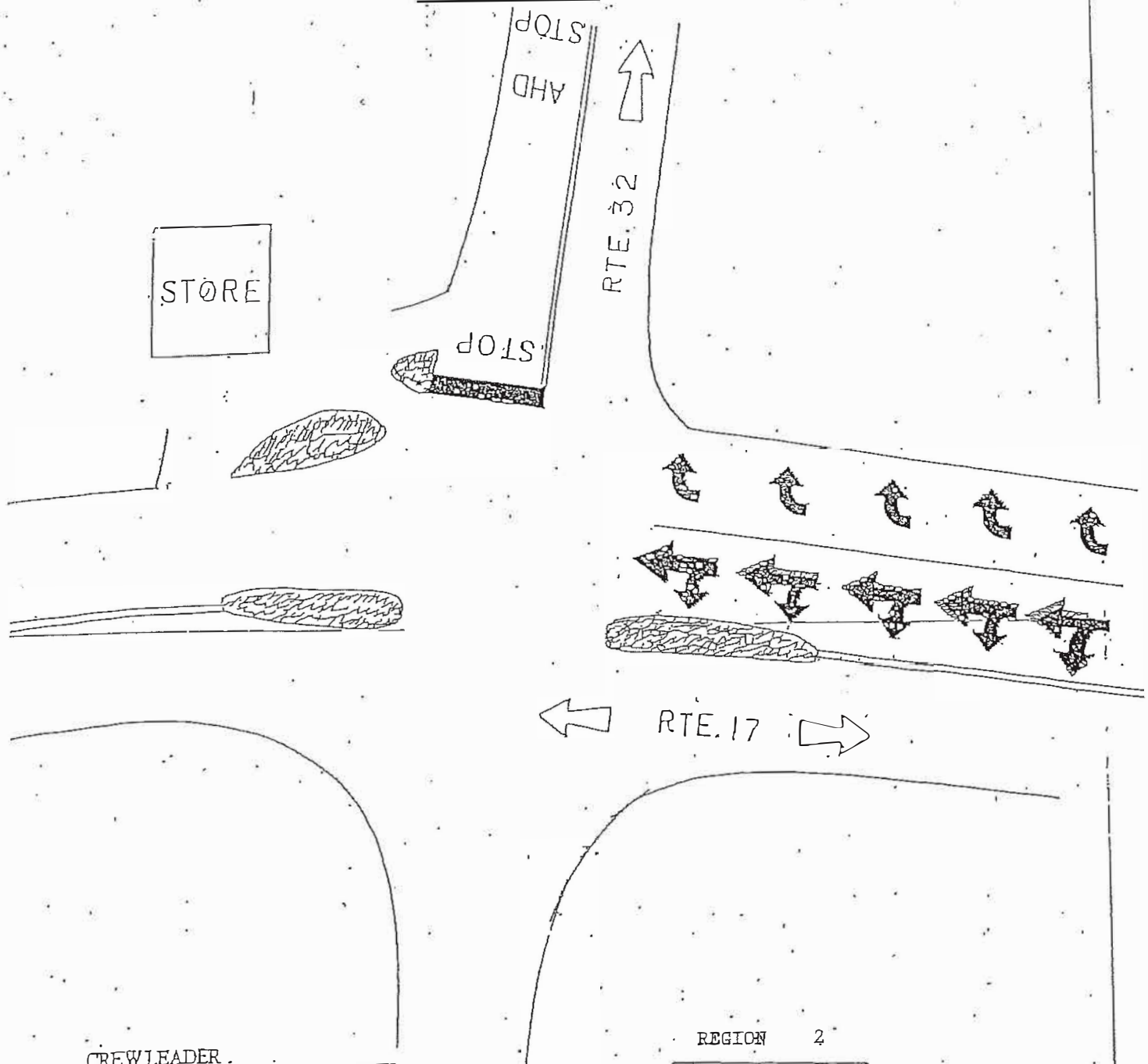

CREWLEADER _____
 YES NO.
 PROJECT DONE BEFORE _____

REGION 2
 TOWN WINDSOR

904605

PAVEMENT MARKINGS

Project No. _____

904605

DESCRIPTION OF WORK DONE

STRAIGHT ARROW _____	LANE LINE _____
TURN ARROW _____	STOP _____ 44 _____
STOP BAR _____ 46 _____	ONLY _____
CURBING-YELLOW _____	STOP AHEAD _____ 37 _____
WHITE _____	CROSSWALKS _____
HASH MARKS _____	TOTAL SQ. FT. _____ 127 _____
MISC. _____	

DIAGRAM OF WORK

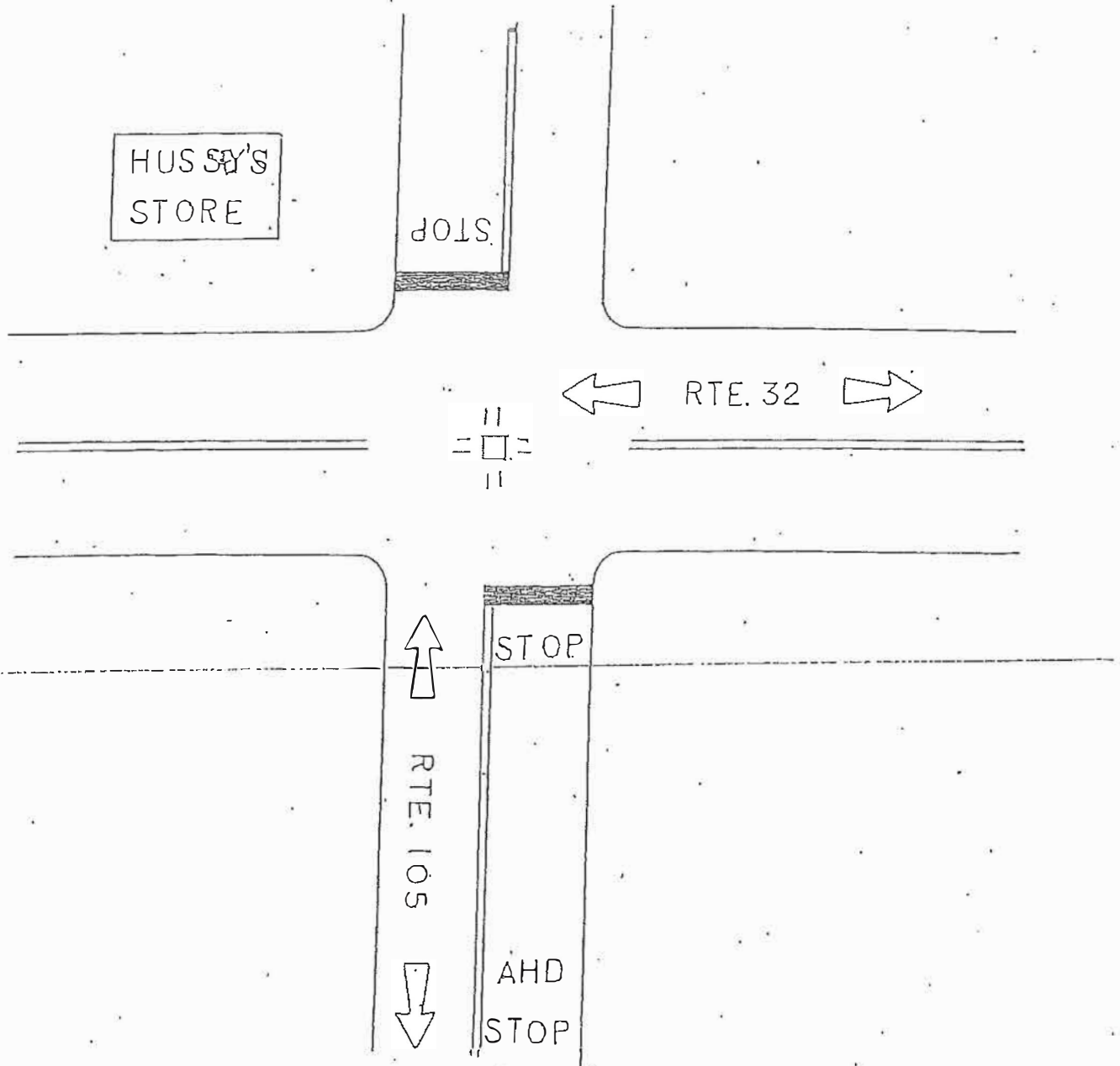

CREW LEADER. _____ YES NO

PROJECT DONE BEFORE _____
DATE _____

REGION 2

TOWN WINDSOR
ROUTE OR 105 & 32

PAVEMENT MARKINGS

Project No. _____

904635

DESCRIPTION OF WORK DONE

STRAIGHT ARROW	26	COMBO	29
TURN ARROW	64	LANE LINE	_____
STOP BAR	_____	STOP ONLY	_____
CURBING-YELLOW	_____	STOP AHEAD	_____
WHITE	_____	CROSSWALKS	_____
HASH MARKS	_____	TOTAL SQ. FT.	180
MISC. YIELD AHD & YIELD BAR	61		

DIAGRAM OF WORK

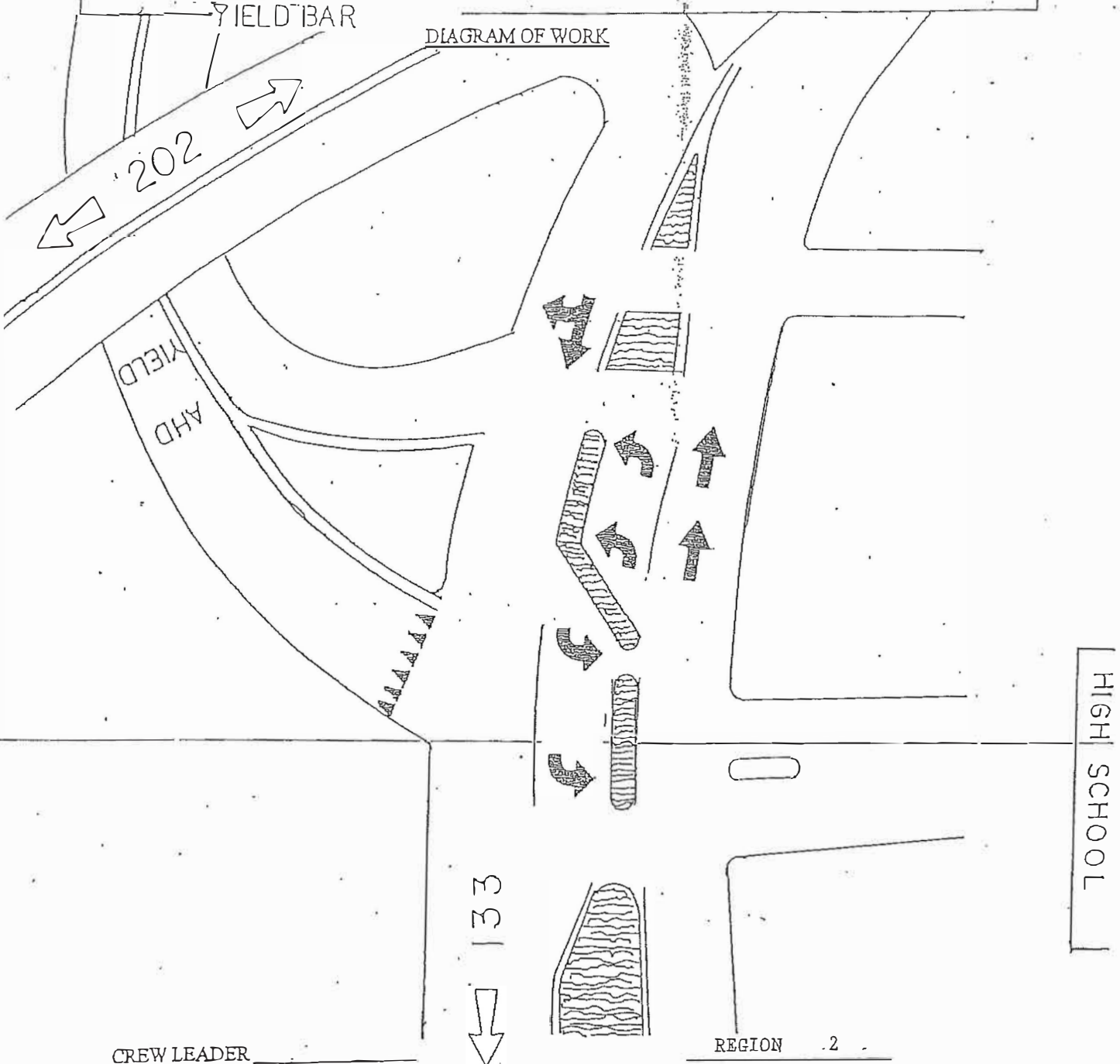

CREW LEADER _____ YES NO

PROJECT DONE BEFORE _____

DATE _____

ACTUAL JOB TIME _____

REGION .2

TOWN WINTHROP
 ROUTE OR 133 & HIGH SCHOOL
 ROAD NO. _____

Railroad Crossing

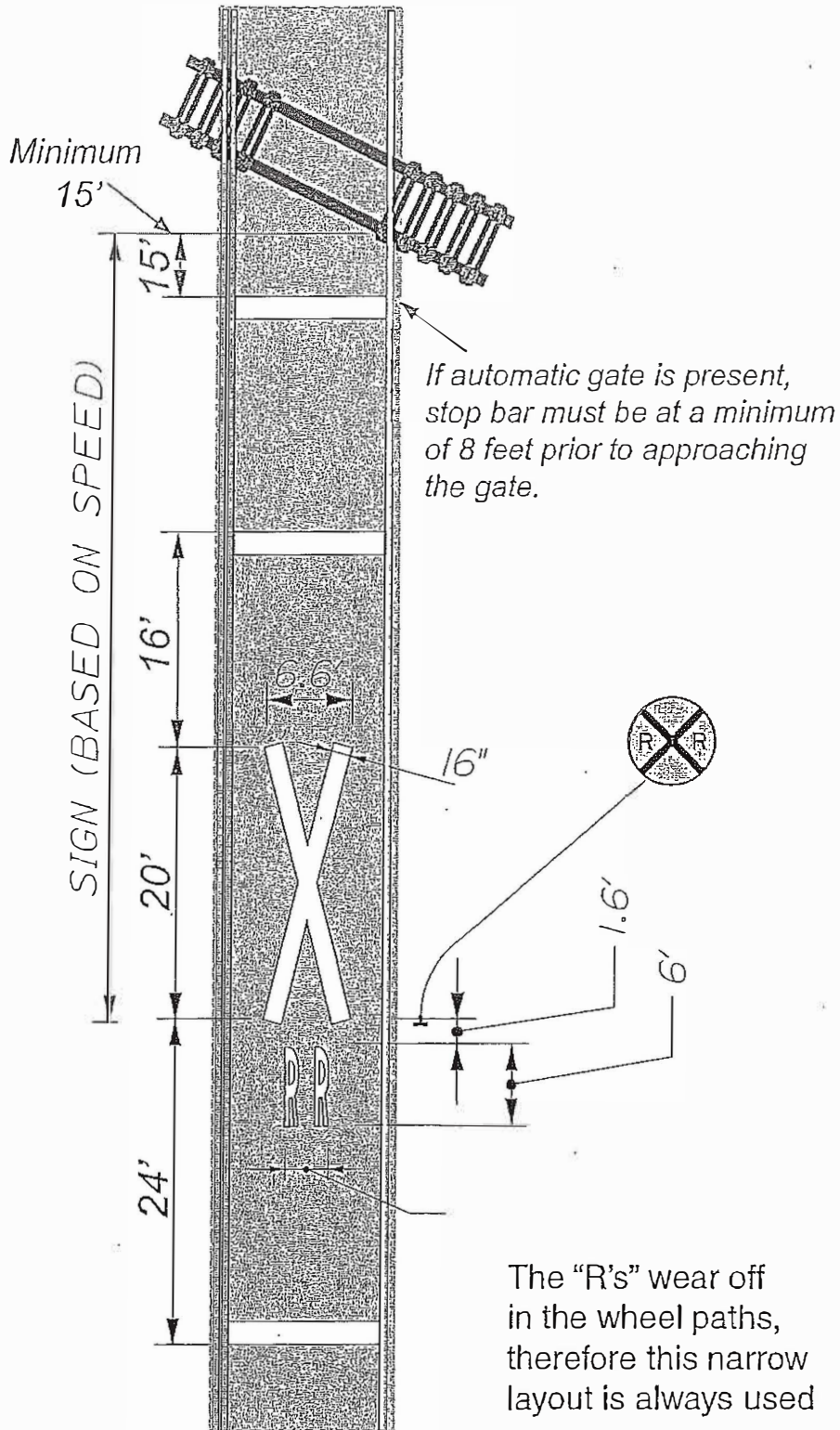

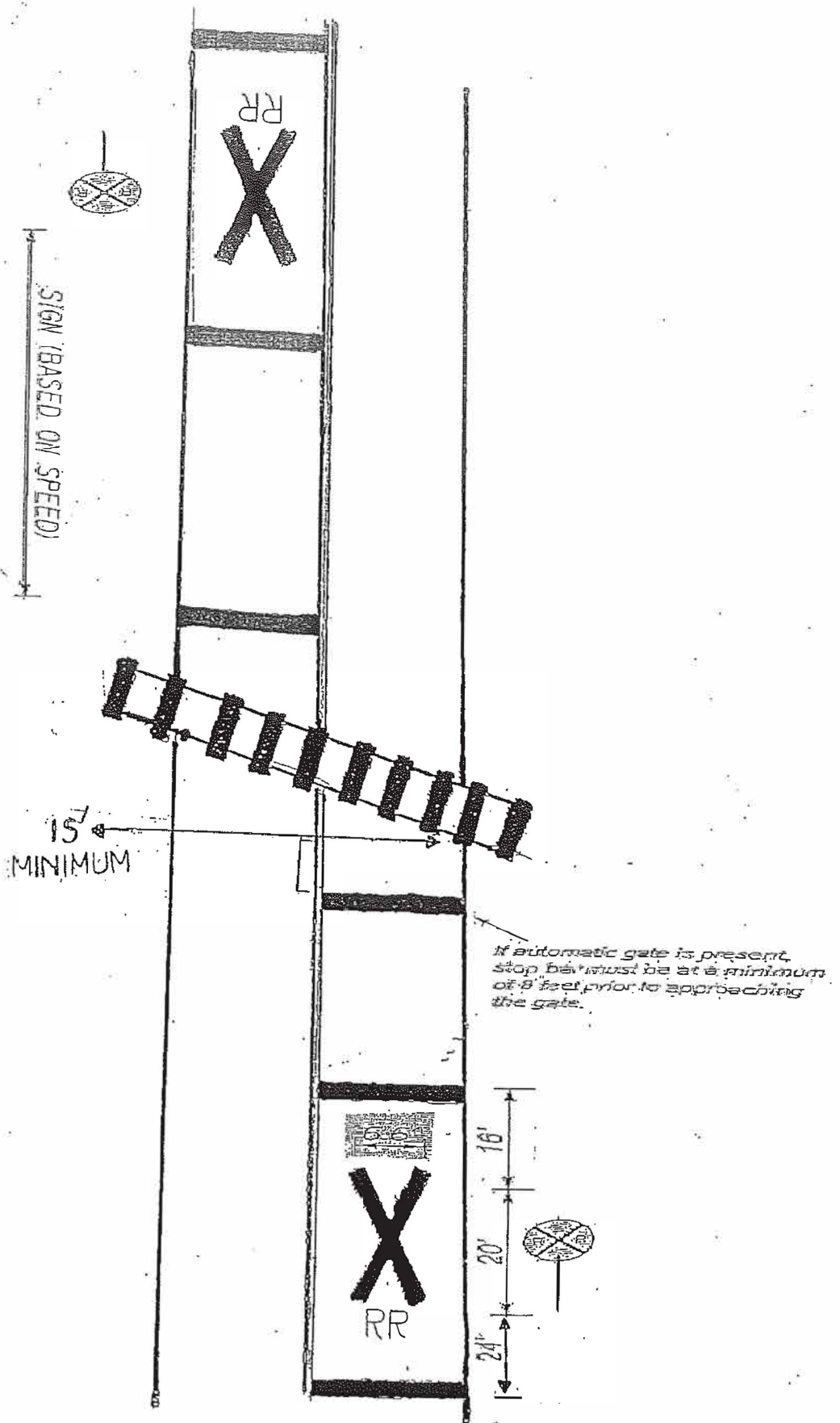

LANE REDUCTION ARROW

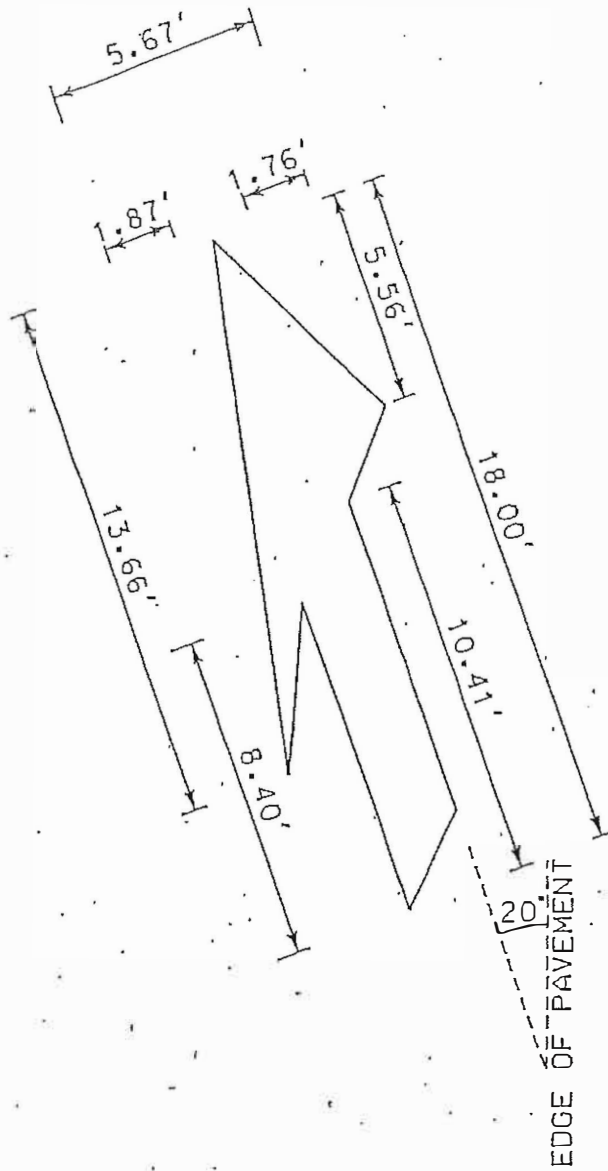

37.90 Square Feet.

PROPORTIONATE
NOT TO SCALE

SHEET NUMBER 1	DATE 5/16/2014	DRAWN CSC	CHECKED	REV.
				1

A - Lane reduction

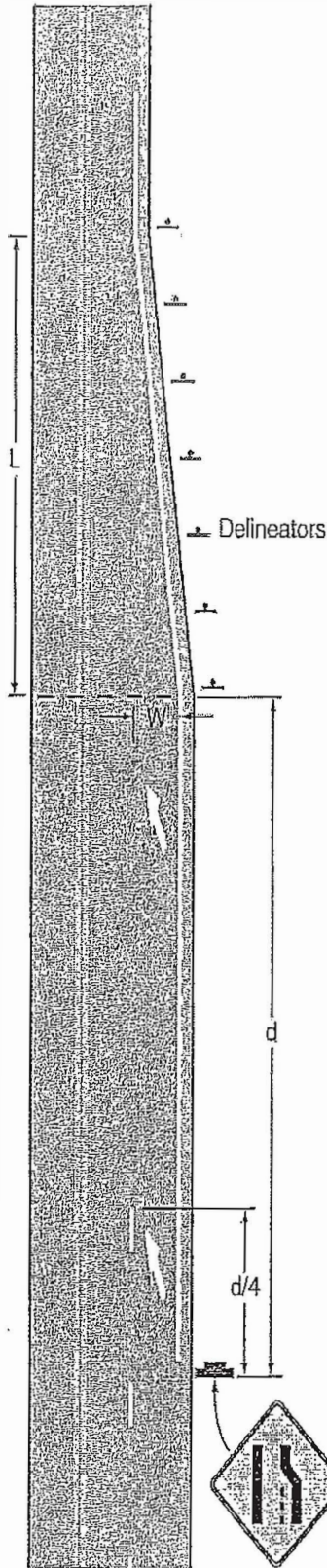

B - Lane reduction with lateral shift to the left

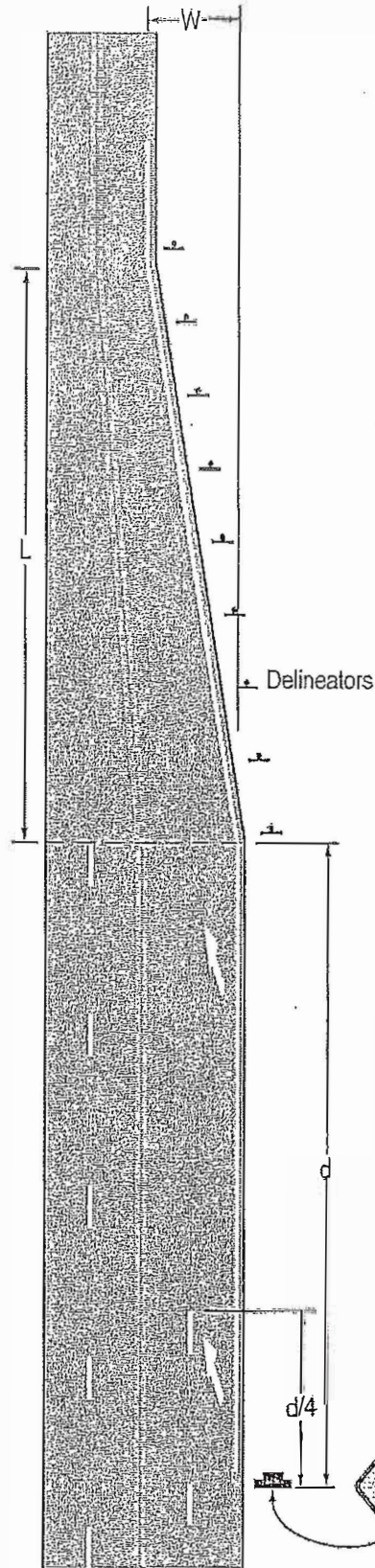

Notes:

1. Lane-reduction arrows are optional for speeds of less than 45 mph
2. See Section 3F.04 for delineator spacing
3. $L = WS$ for speeds of 45 mph or greater and $L = WS^2/60$ for speeds of less than 45 mph, where:

L = Length of taper in feet
 S = Posted, 85th-percentile, or statutory speed in mph
 W = Offset in feet

4. d = Advance warning distance (see Section 2C.05)

Region 3 Pavement Markings

Town	Asset #	Sq Feet	Location	Map#	Type
Anson	904969	32	201A & 148	20	Intersection
Athens	920973	122	43 & 151	31	Intersection
Athens	1038975	88	151+150	31	Intersection
Bethel	904972	239	2 & 26	10	Intersection
Bethel	904976	175	26 & Parkway	10	Intersection
Bethel	904974	660	2 & Parkway	10	Intersection
Bethel	1103640	64	2 & Riverside Ln	10	Intersection
Bethel	905158	84	2 & Flat Rd.	10	Intersection
Bethel	1034452	100	East Bethel+ Intervale	10	Intersection
Bethel	953278	168	0002X	10	LRA
Bethel	953285	84	0002X	10	LRA
Bethel	904935	275	Main Street	10	Rail Road
Bingham	1081102	84	16+201	30	Intersection
Bingham	1081104	40	16+201	30	Intersection
Brighton Plt	1003743	48	154+151	31	Intersection
Buckfield	904971	192	124	11	Intersection
Buckfield	904979	64	117 & 140	11	Intersection
Cambridge	1002878	37	152+150	31	Intersection
Canaan	904981	40	2 & 23	21	Intersection
Cannan	1080857	54	23+2	21	Intersection
Canton	904983	154	108 & 140 & Main	11	Intersection
Canton	904937	260	Canton Point Rd.	11	Rail Road
Chesterville	1038805	60	156+41	20	Intersection
Cornville	1038790	62	43+150	21	Intersection
Dixfield	904987	197	2 & 142	19	Intersection
Dixfield	953219	168	0002X	19	LRA
Eustis	1081168	52	16+27	29	Intersection
Farmington	904989	177	4 & 27	20	Intersection
Farmington	905087	107	156 & Corner Rd.	20	Intersection
Farmington	1038802	45	41+2	20	Intersection
Farmington	1010893	84	0002X	19	LRA
Freeman TWP	1038832	75	145+142	29	Intersection
Harmony	1002865	51	154+150	31	Intersection
Hartland	1080853	20	151+23	21	Intersection
Hartland	1080855	44	152+23	21	Intersection
Industry	1038796	60	148+43	20	Intersection
Jackman	1078709	84	0201X	39/40	LRA
Jackman	904939	275	State Street	39	Rail Road
Jay	905030	986	133 & 156	19	Intersection
Jay	905026	477	4 & 17 & Riley Rd.	19	Intersection
Jay	905028	86	4 & 17 & 140	19	Intersection
Jay	953202	84	0004X	19	LRA

Region 3 Pavement Markings

Town	Asset #	Sq Feet	Location	Map#	Type
Jay	953204	84	0004X	19	LRA
Jay	904941	260	Crash Road	11	Rail Road
Kingfield	905032	62	16 & 27	30	Intersection
Livermore	905034	88	4 & 108	11	Intersection
Livermore	953200	84	0004X	11	LRA
Livermore Falls	953198	84	0133X	12	LRA
Livermore Falls	905038	143	17 & 133	11	Intersection
Livermore Falls	905052	465	4 & 17 & 133	11	Intersection
Livermore Falls	904943	260	Bridge Street	11	Rail Road
Livermore Falls	904945	260	Main Street	11	Rail Road
Livermore Falls	904947	260	Depot Street	11	Rail Road
Madison	905054	158	43 & 201	20	Intersection
Madison	1078702	84	0201X	20/21	LRA
Madison	1078704	84	0201X	20/21	LRA
Madison	1078706	84	0201X	20/21	LRA
Mayfield Twp	1037632	60	151+16	31	Intersection
Mercer	1038814	60	137+2	20	Intersection
Mexico	905056	96	2	19	Intersection
Mexico	905063	236	2	19	Intersection
New Portland	905070	133	27 & 146	20	Intersection
New Sharon	905083	143	2 & 27	20	Intersection
New Sharon	905085	100	2 & 134	20	Intersection
New Sharon	1038810	60	134+2	20	Intersection
New Sharon	1038808	90	134+41	20	Intersection
New Vineyard	1038955	30	234+27	20	Intersection
New Vineyard	1038958	60	234+27/Anson Valley Rd	20	Intersection
N. New Portland	905081	103	146 & 16	30	Intersection
Norridgewock	905089	285	2 & 201A & 8	20	Intersection
Norridgewock	905095	93	139	20	Intersection
Norridgewock	905097	189	2 & Airport Rd.	20	Intersection
Paris	904959	260	Main Street	11	Rail Road
Paris	904961	260	High Street	11	Rail Road
Peru	904967	260	Hammonds Ferry	19	Rail Road
Peru	905099	188	Route 108	19	Intersection
Peru	905107	96	108 Auburn Rd	19	Intersection
Phillips	990223	101	4 & 142	19	Intersection
Phillips	1003745	125	142+4+149	19	Intersection
Phillips	953222	168	0004X	19	LRA
Rangeley	953267	84	0004X	28	LRA
Rangeley	953269	84	0004X	28	LRA
Rangeley	953272	84	0004X	28	LRA
Rangeley	953274	84	0004X	28	LRA

Region 3 Pavement Markings

Town	Asset #	Sq Feet	Location	Map#	Type
Rangeley	905119	32	4 & South Shore Dr.	28	Intersection
Rangeley	905122	91	16 & Pleasant St.	28	Intersection
Rangeley	905128	88	4 & 16	28	Intersection
Ripley	1002880	48	152+154	31	Intersection
Ripley	1038825	50	23+152+154	31	Intersection
Sandy River PLT	953265	84	0004X	19	LRA
Shirley	1010895	84	0006X	41	LRA
Skowhegan	905133	80	201	21	Intersection
Skowhegan	905135	64	201	21	Intersection
Smithfield	1038820	50	137+8	20	Intersection
Starks	1038792	40	134+43	20	Intersection
St. Albans	1080851	30	43+23	21/31	Intersection
Strong	905137	275	4 & 145	19	Intersection
Strong	1081164	108	149+145	19	Intersection
Strong	1081166	25	149+145	19	Intersection
Taunton & Raynham	904963	275	Tarrantine/Jackman	40	Rail Road
Temple	1034448	21	43+Intervale Rd	19	Intersection
Turner	905143	129	117 & 219	11	Intersection
Turner	905156	558	4+219	11	Intersection
Turner Center	905154	362	117 & Allan Pond	11	Intersection
Weld	1034450	195	156+142	19	Intersection
West Forks	1078716	84	0201X	40	LRA
West Paris	905161	89	26 & 219	11	Intersection
West Paris	904965	260	Main Street	11	Rail Road
Wilton	905163	333	2 & Maxwell Rd.	19	Intersection
Wilton	905165	782	2 & 156	19	Intersection
Wilton	905167	492	2 & 4	19	Intersection
Wilton	953194	634	2 & D.D.	19	Intersection
Wilton	953212	168	0002X	19	LRA
Woodstock	953276	84	0026X	10	LRA
Total Square feet		17865			

ASSET ID Q04969

PAVEMENT MARKINGS

Project No. _____

DESCRIPTION OF WORK DONE mile point 13.60

STRAIGHT ARROW _____	LANE LINE _____
TURN ARROW <u>32</u>	STOP _____
STOP BAR _____	ONLY _____
CURBING-YELLOW _____	STOP AHEAD _____
WHITE _____	CROSSWALKS _____
HASH MARKS _____	TOTAL SQ. FT. <u>32</u>
MISC. _____	

DIAGRAM OF WORK

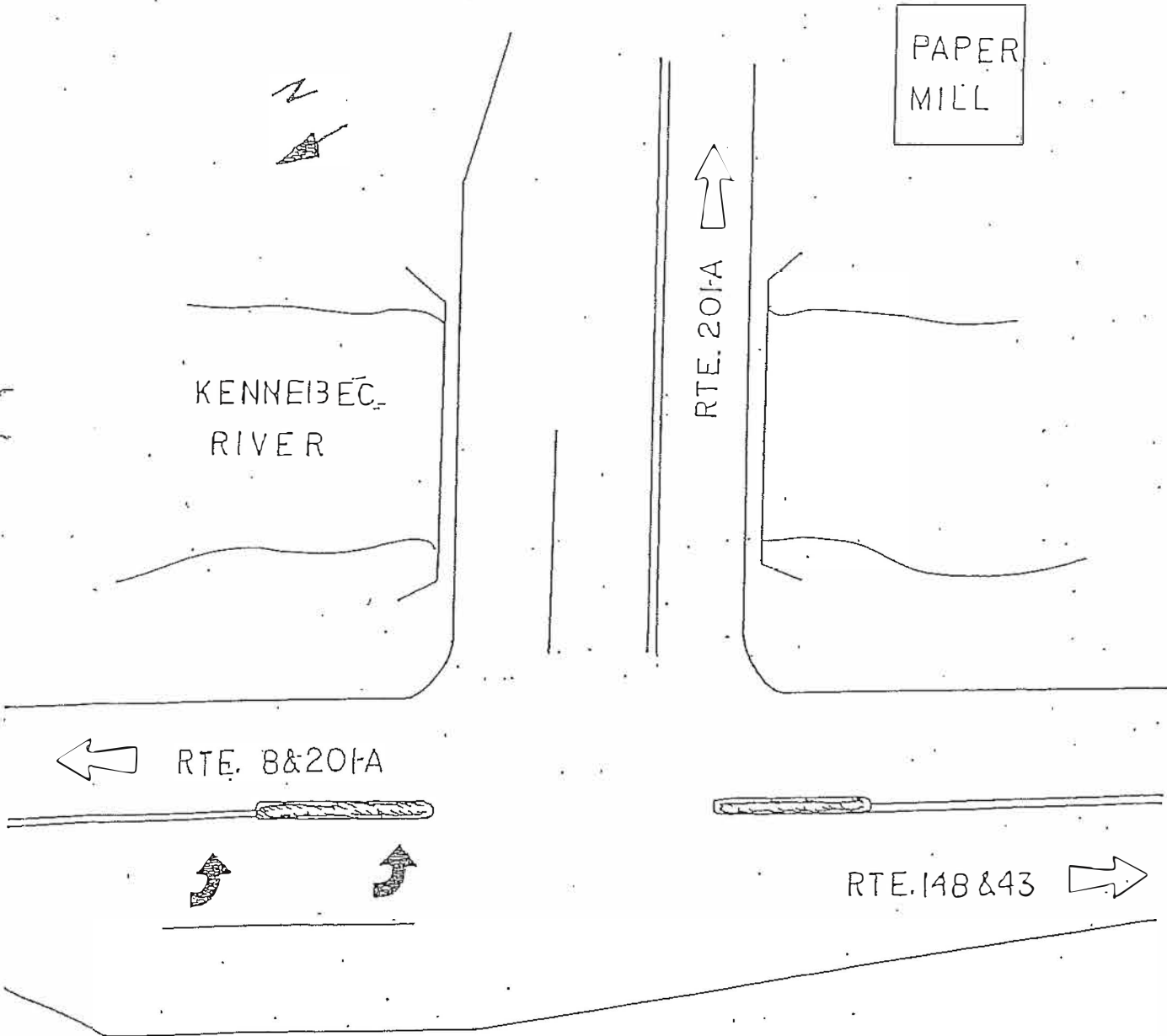

CREW LEADER _____ YES NO
 PROJECT DONE BEFORE _____
 DATE _____
 ACTUAL JOB TIME _____

REGION 3
 TOWN ANSON
 ROUTE OR. 201A & 148
 ROAD NO. _____

PAVEMENT MARKINGS

Project No. 920913

DESCRIPTION OF WORK DONE

STRAIGHT ARROW _____	YIELD <u>23</u>
TURN ARROW _____	STOP <u>44</u>
STOP BAR <u>40</u>	ONLY _____
WHITE _____	STOP AHEAD _____
HASH MARKS _____	CROSSWALKS _____
MISC. <u>YIELD BAR 15</u>	TOTAL SQ. FT. <u>122</u>

DIAGRAM OF WORK

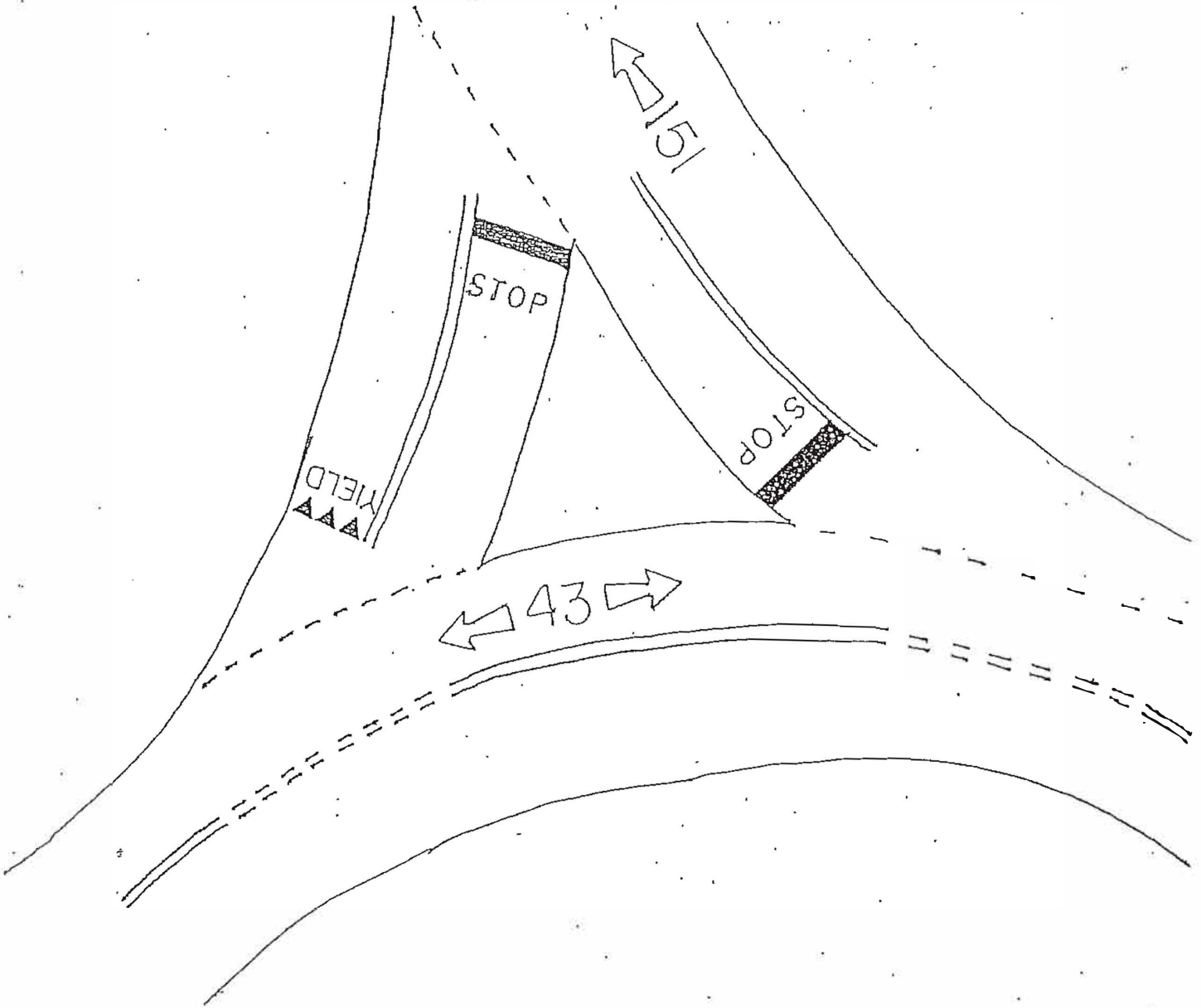

CREW LEADER _____
 YES NO
 PROJECT DONE BEFORE _____
 DATE _____
 ACTUAL JOB TIME _____

TOWN ATHENS
 ROUTE OR 43 & 151
 ROAD NO. _____

DESCRIPTION OF WORK DONE

STRAIGHT ARROW _____	LANE LINE # 1038975
TURN ARROW _____	STOP 21
STOP BAR 28	ONLY _____
CURBING-YELLOW _____	STOP AHEAD 39
WHITE _____	CROSSWALKS _____
HASH MARKS _____	TOTAL SQ. FT. 88
MISC. _____	

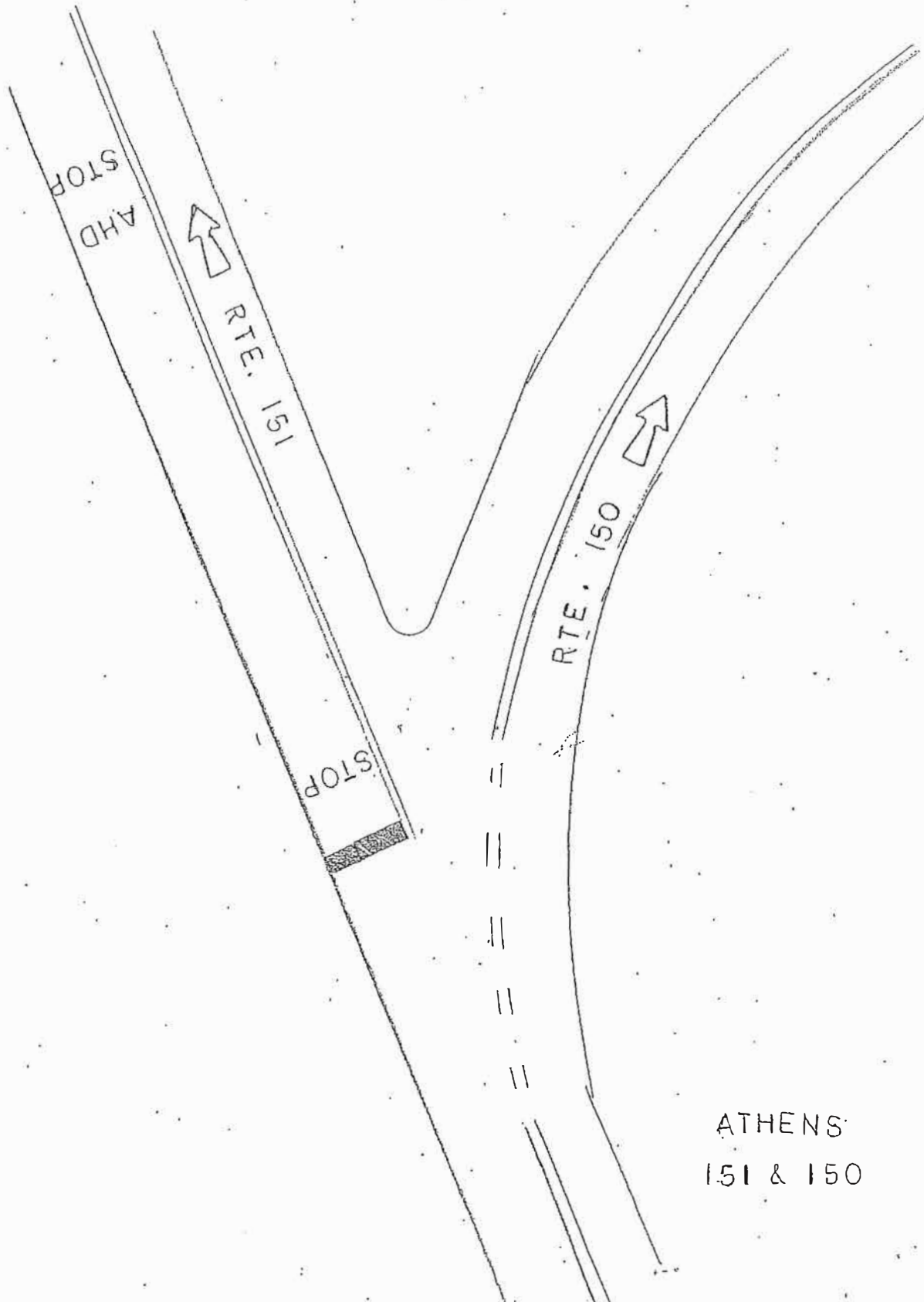

904972

PAVEMENT MARKINGS

Project No. _____

DESCRIPTION OF WORK DONE

STRAIGHT ARROW	39	LANE LINE	_____
TURN ARROW	32	STOP	_____
STOP BAR	44	ONLY	_____
CURBING-YELLOW	_____	STOP AHEAD	_____
WHITE	_____	CROSSWALKS	_____
HASH MARKS	_____	TOTAL SQ. FT.	239
MISC. CHEVRON	124		

DIAGRAM OF WORK

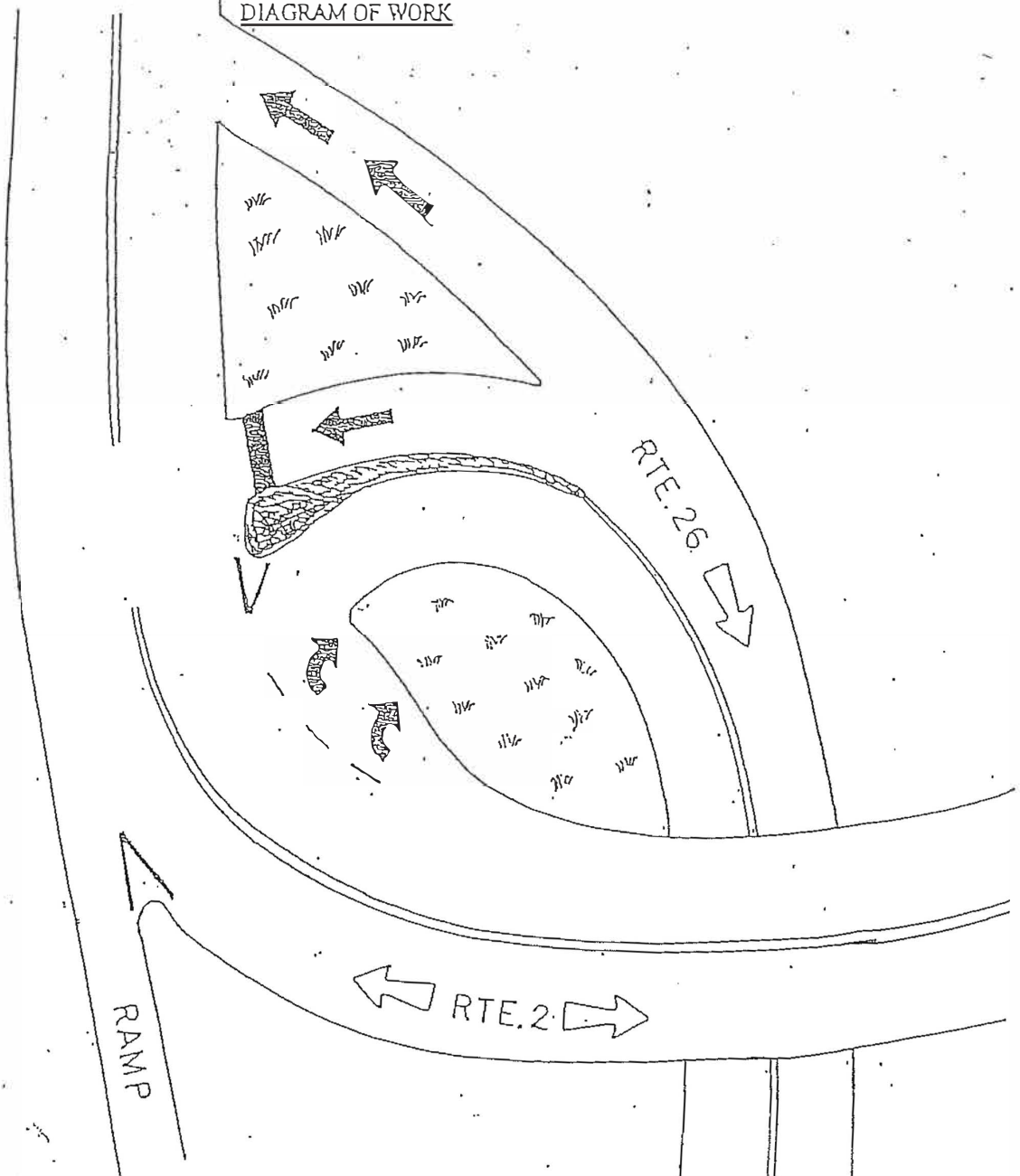

CREW LEADER _____
 PROJECT DONE BEFORE YES NO _____
 DATE _____
 ACTUAL JOB TIME _____

REGION 3

TOWN BETHEL
 ROUTE OR 2 & 26
 ROAD NO.

904976

PAVEMENT MARKINGS

Project No. _____

DESCRIPTION OF WORK DONE

STRAIGHT ARROW _____	LANE LINE _____ 45 _____
TURN ARROW _____ 32 _____	STOP _____
STOP BAR _____ 98 _____	ONLY _____
CURBING-YELLOW _____	STOP AHEAD _____
WHITE _____	CROSSWALKS _____
HASH MARKS _____	TOTAL SQ. FT. _____ 175 _____
MISC. _____	

DIAGRAM OF WORK

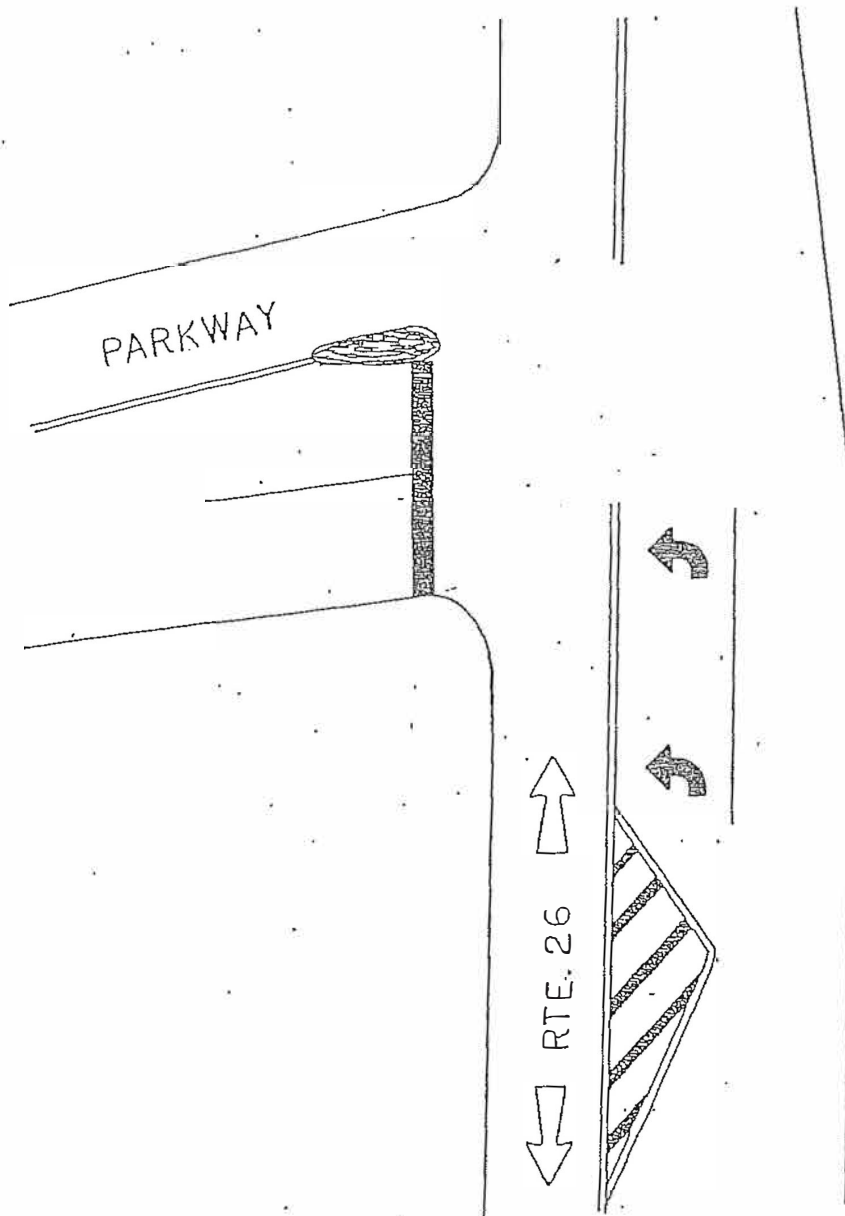

CREW LEADER _____

YES NO

PROJECT DONE BEFORE _____

DATE _____

ACTUAL JOB TIME _____

REGION 3

TOWN BETHEL

ROUTE OR 26 &

ROAD NO. PARKWAY

904974

PAVEMENT MARKINGS

Project No. _____

DESCRIPTION OF WORK DONE

STRAIGHT ARROW _____	LANE LINE _____
TURN ARROW <u>112</u>	STOP _____
STOP BAR <u>82</u>	ONLY _____
CURBING-YELLOW _____	STOP AHEAD _____
WHITE _____	CROSSWALKS _____
HASH MARKS <u>350</u>	TOTAL SQ. FT. <u>660</u>
MISC. <u>COMB. ARROWS 116</u>	

DIAGRAM OF WORK

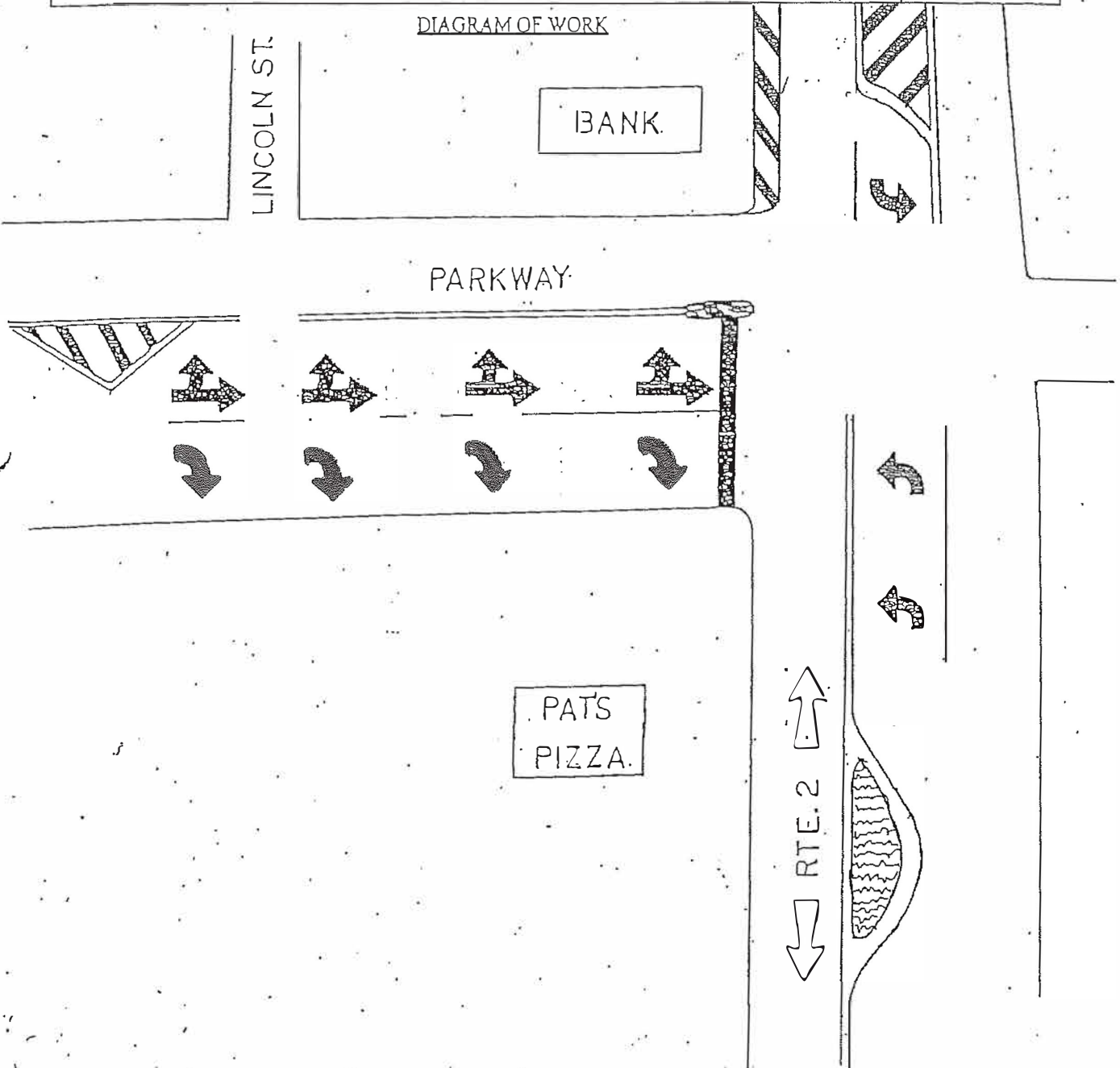

CREW LEADER _____ YES NO

PROJECT DONE BEFORE _____ DATE _____

REGION 3

TOWN BETHEL ROUTE OR 2 &

PAVEMENT MARKINGS

Project No. _____

DESCRIPTION OF WORK DONE

Bethel	Asset: 1103640
Total Sq. Feet: 64	
Turn Arrows: 64	Route 2

DIAGRAM OF WORK

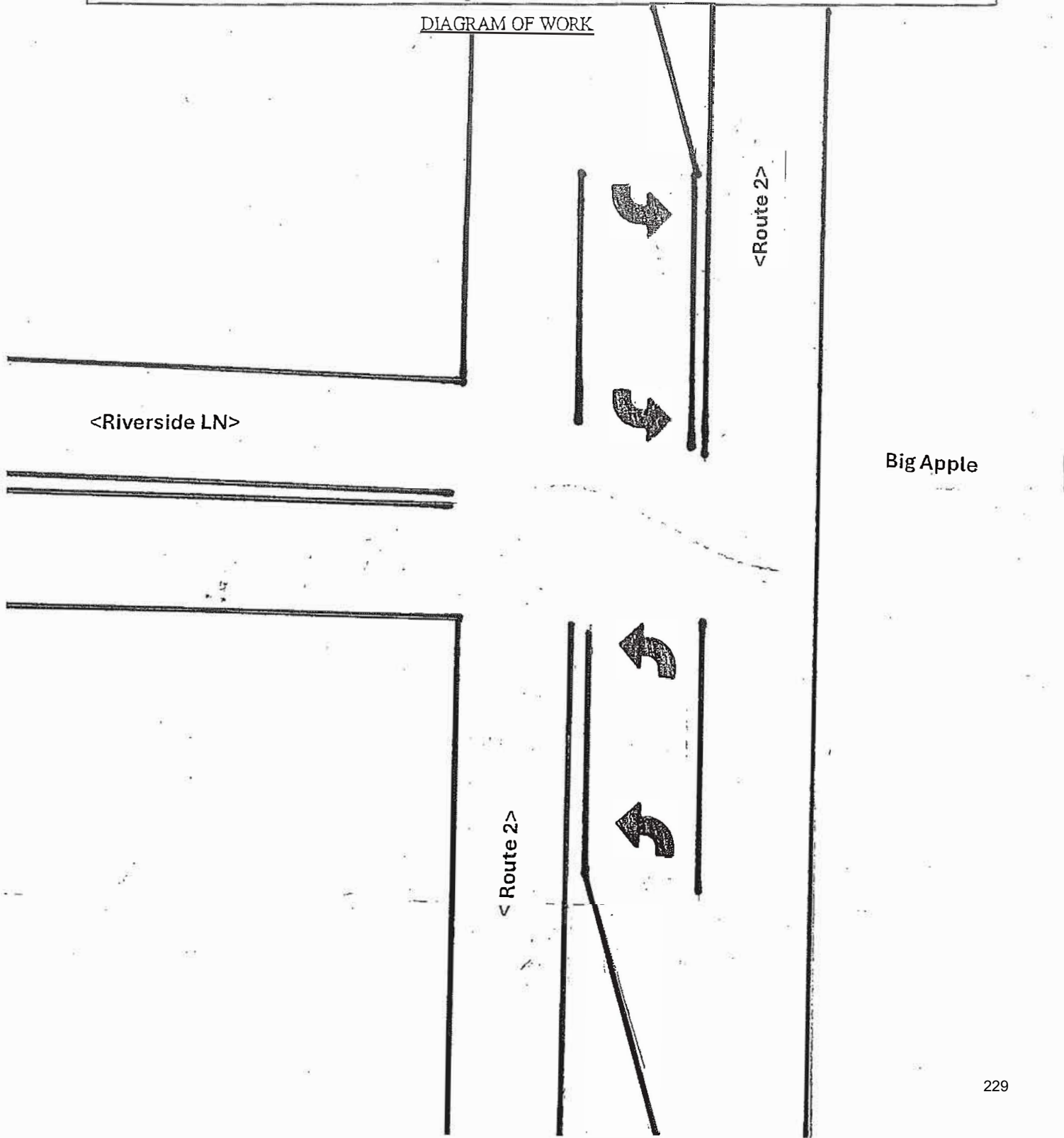

PAVEMENT MARKINGS

Project No. 905158

DESCRIPTION OF WORK DONE

STRAIGHT ARROW	<u>26</u>	LANE LINE	_____
TURN ARROW	_____	STOP	_____
STOP BAR	_____	ONLY	_____
CURBING-YELLOW	_____	STOP AHEAD	_____
WHITE	_____	CROSSWALKS	_____
HASH MARKS	_____	TOTAL SQ. FT.	<u>84</u>
MISC. COMBOS	<u>58</u>		

DIAGRAM OF WORK

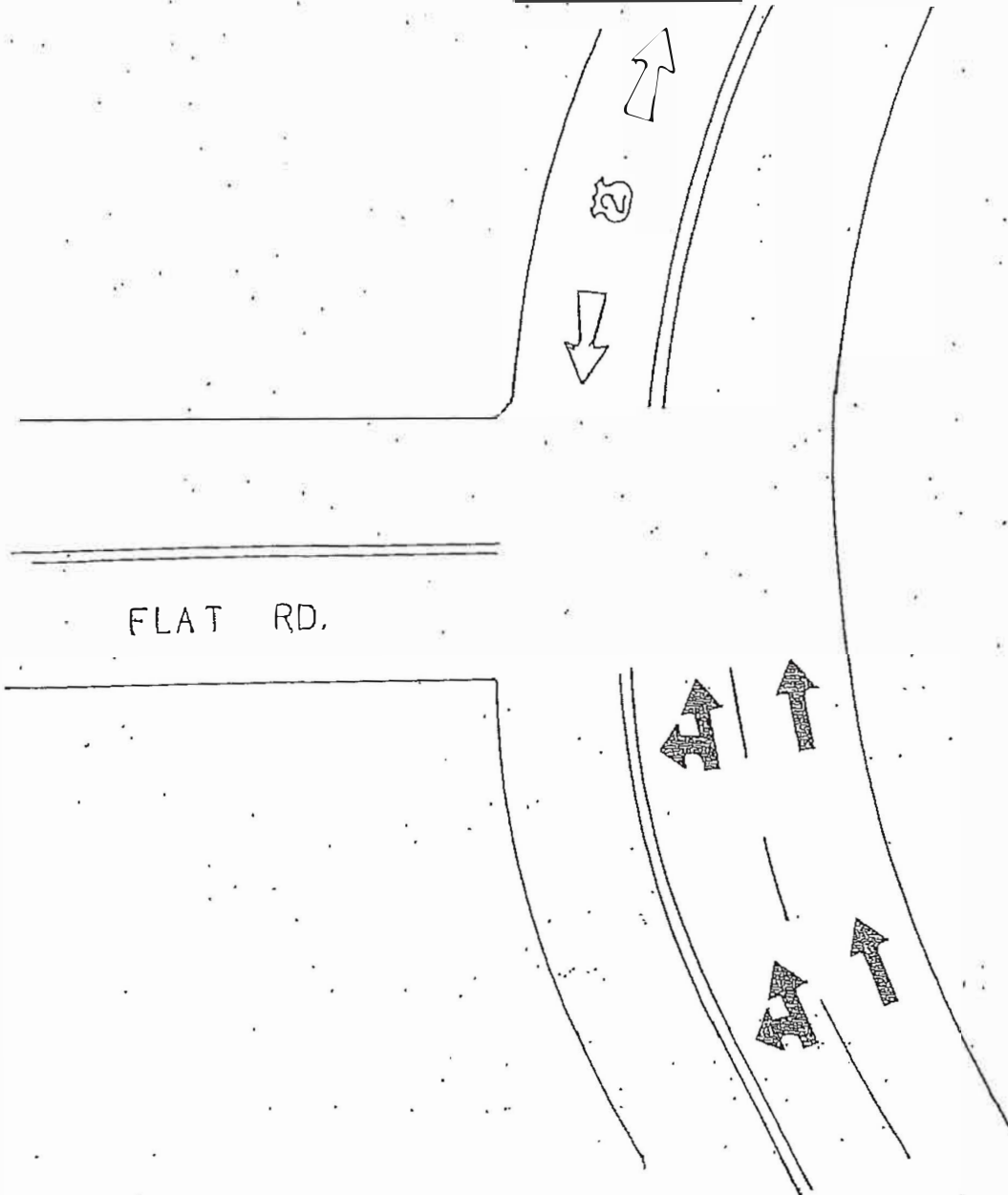

CREW LEADER _____
YES . NO

PROJECT DONE BEFORE _____
DATE _____

DIVISION _____

TOWN BETHEL
ROUTE OR 2 & FLAT RD.
ROAD NO. _____

PAVEMENT MARKINGS

Project No. _____

1034452

DESCRIPTION OF WORK DONE

STRAIGHT ARROW _____	LANE LINE _____
TURN ARROW _____	STOP _____
STOP BAR _____ 61 _____	ONLY _____
CURBING-YELLOW _____	STOP AHEAD _____ 39 _____
WHITE _____	CROSSWALKS _____
HASH MARKS _____	TOTAL SQ. FT. _____ 100 _____
MISC. _____	

DIAGRAM OF WORK

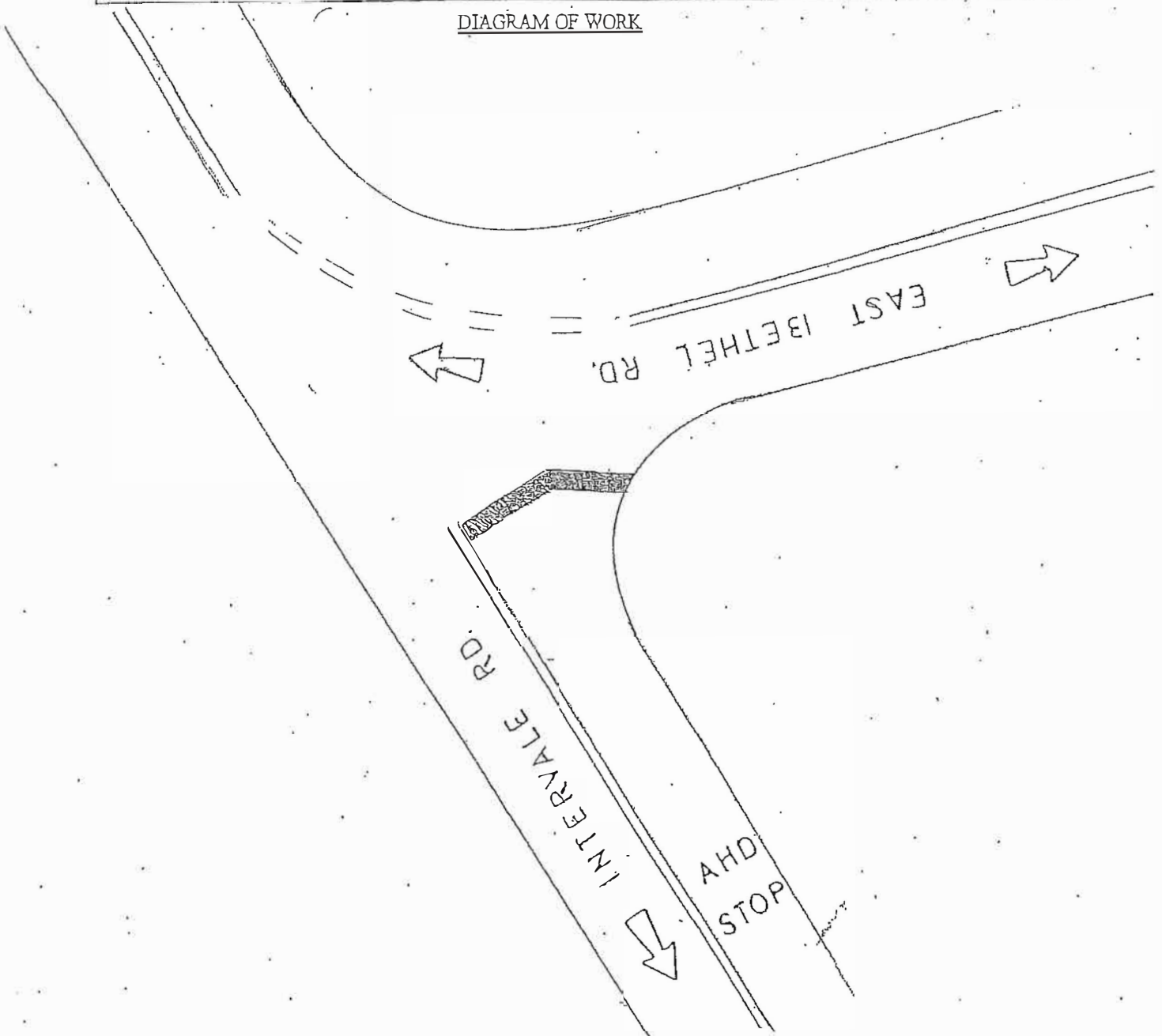

CREW LEADER _____
YES NO
PROJECT DONE BEFORE _____
DATE _____
ACTUAL JOB TIME _____

DIVISION _____
TOWN E. BETHEL
ROUTE OR INTERVALE RD.
ROAD NO. & EAST BETHEL RD.

PAVEMENT MARKINGS

Project No. _____

DESCRIPTION OF WORK DONE

Bingham	Asset: 1081102
Total Sq. Feet: 84	Route 16 and Route 201
Stop Bar: 84	Map: 30

DIAGRAM OF WORK

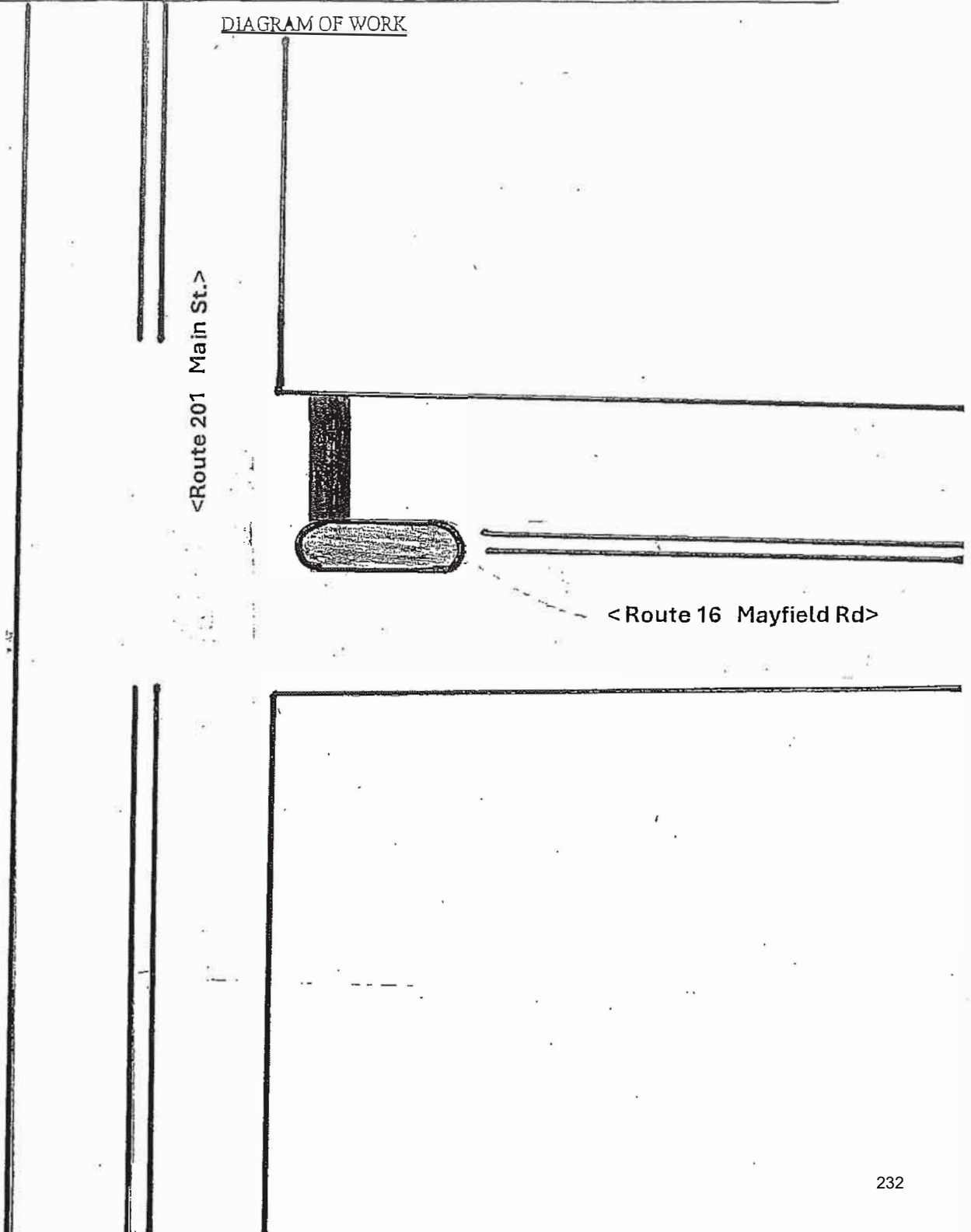

PAVEMENT MARKINGS

Project No. _____

DESCRIPTION OF WORK DONE

Bingham		Asset: 1081104
Total Sq. Feet: 40		Route 16 and Route 201
Stop Bar: 40		Map: 30

DIAGRAM OF WORK

<Route 16 Bridge St.>

<Route 201 Main St.>

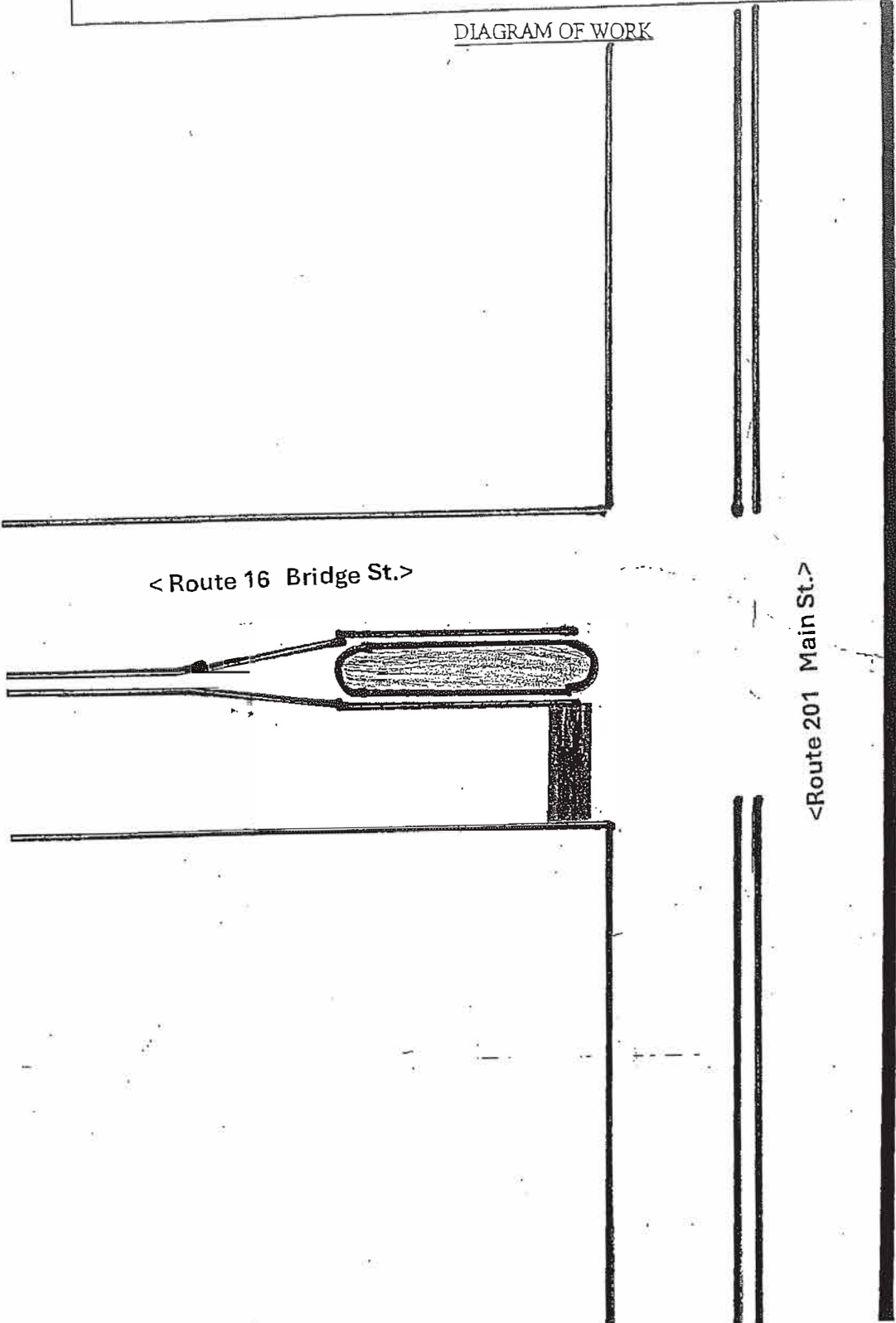

PAVEMENT MARKINGS

Project No. _____

DESCRIPTION OF WORK DONE

Brighton Pl.t		Asset: 1003743
Total Sq. Feet: 48		Route 154 and Route 151
Stop Bar: 48		Map: 31

DIAGRAM OF WORK

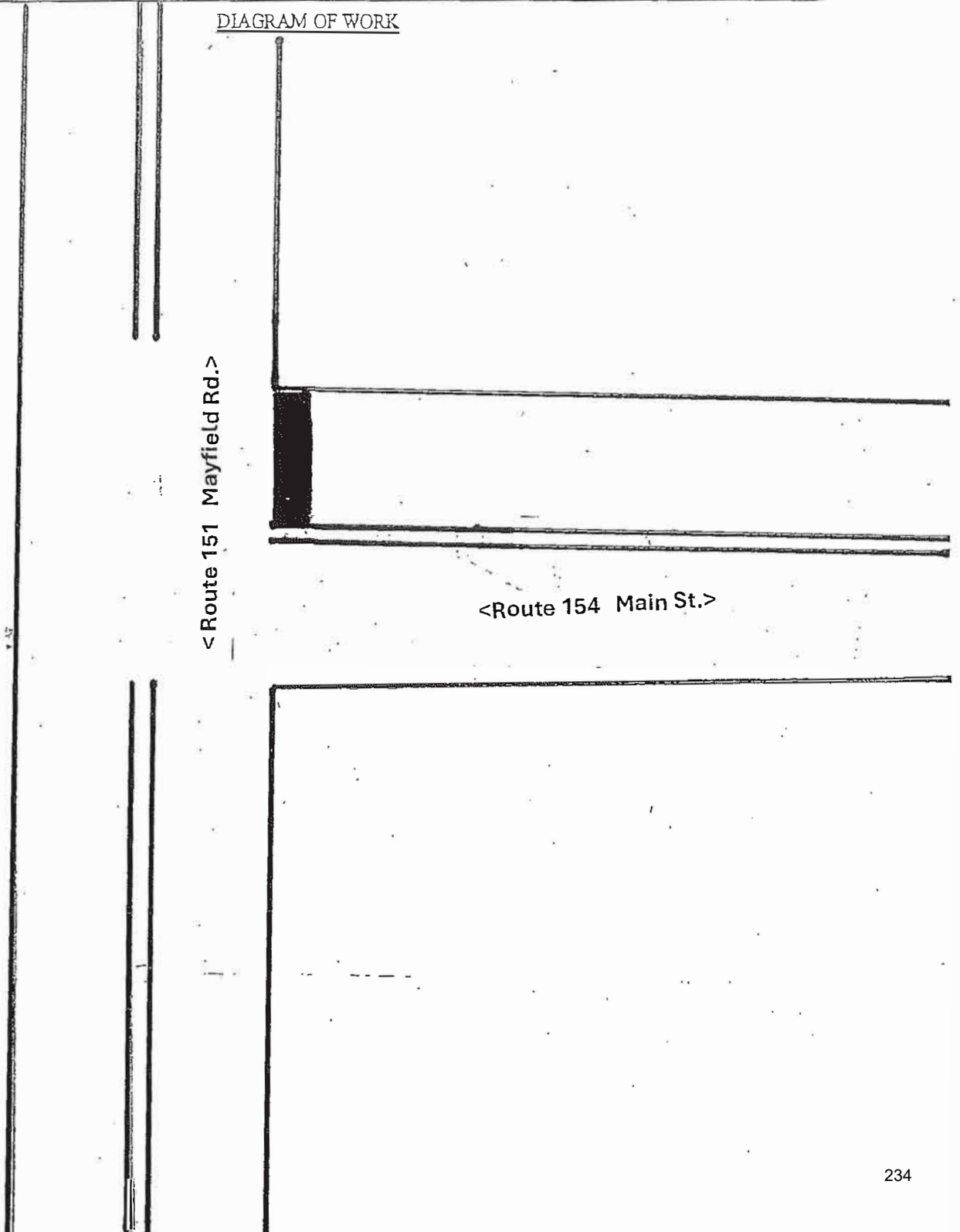

PAVEMENT MARKINGS

904971

Project No. _____

DESCRIPTION OF WORK DONE

STRAIGHT ARROW _____	LANE LINE _____
TURN ARROW _____	STOP _____ 44 _____
STOP BAR _____ 74 _____	ONLY _____
CURBING-YELLOW _____	STOP AHEAD _____ 74 _____
WHITE _____	CROSSWALKS _____
HASH MARKS _____	TOTAL SQ. FT. _____ 192 _____
MISC. _____	

DIAGRAM OF WORK

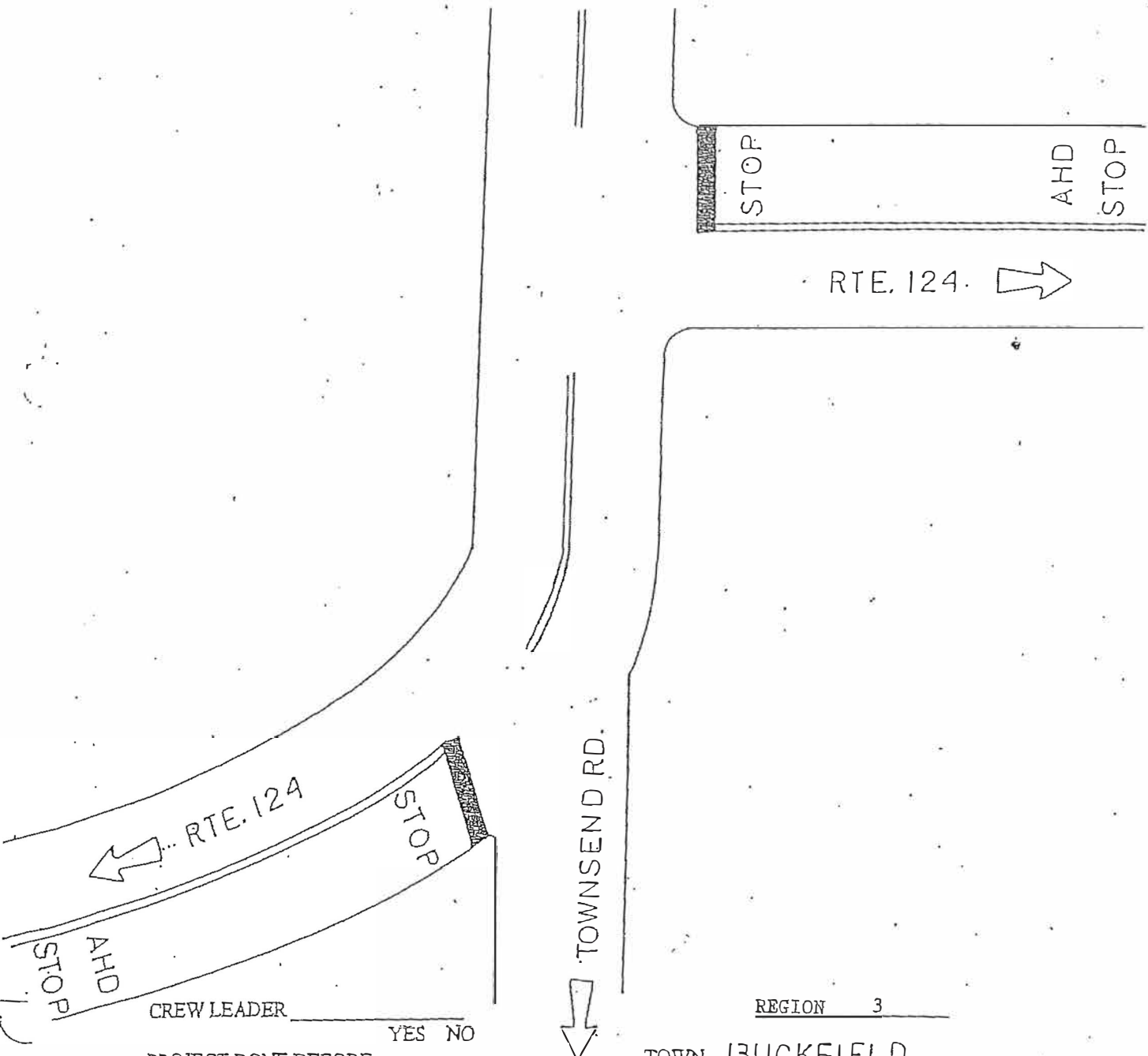

CREW LEADER _____ YES NO

PROJECT DONE BEFORE _____
DATE _____

START TIME _____

REGION 3

TOWN BUCKFIELD
ROUTE OR. 124
ROAD NO. _____

PAVEMENT MARKINGS

904979

Project No. _____

DESCRIPTION OF WORK DONE

STRAIGHT ARROW _____	LANE LINE _____
TURN ARROW _____	STOP _____
STOP BAR _____ 64	ONLY _____
CURBING-YELLOW _____	STOP AHEAD _____
WHITE _____	CROSSWALKS _____
HASH MARKS _____	TOTAL SQ. FT. 64
MISC. _____	

DIAGRAM OF WORK

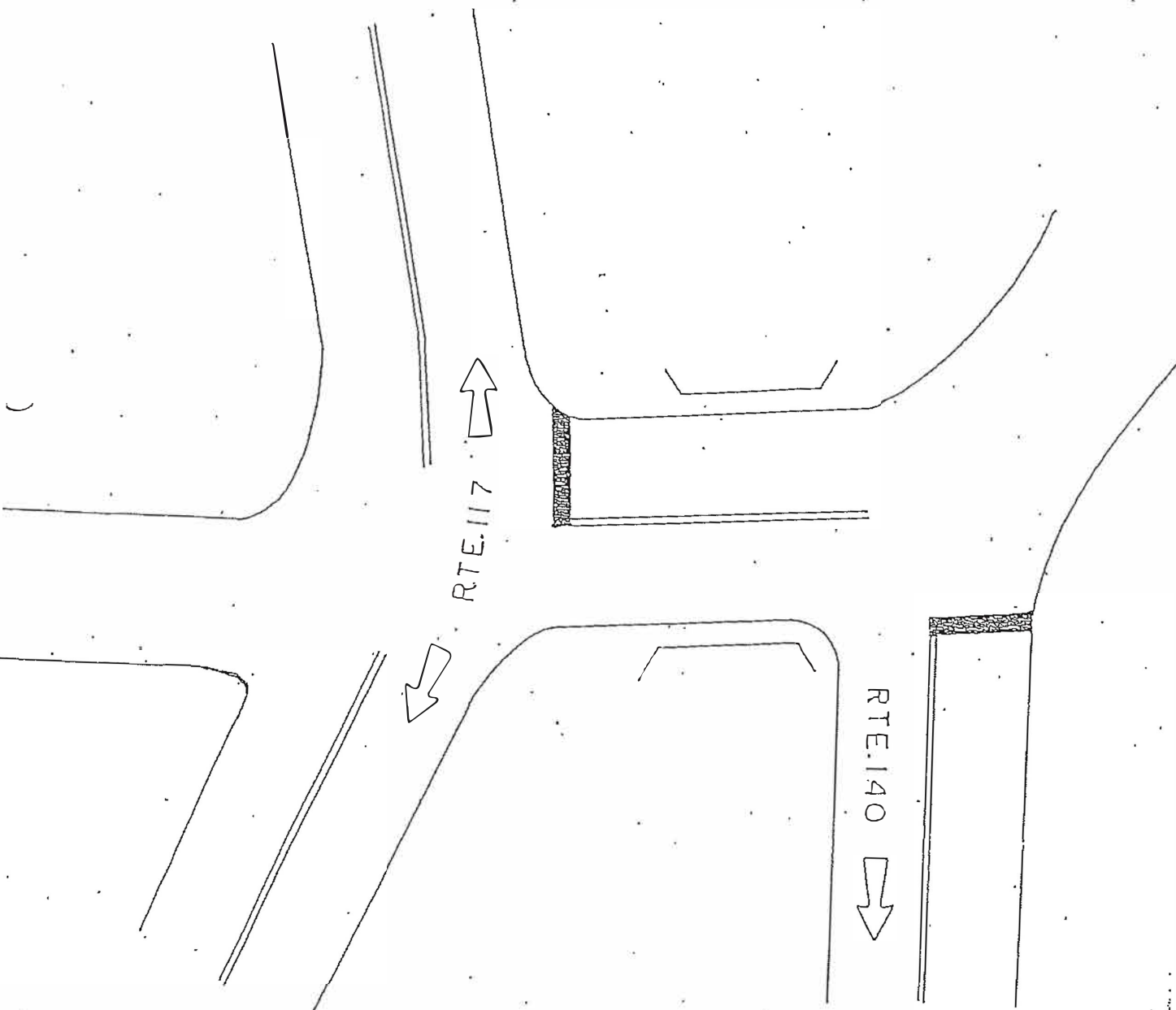

CREW LEADER _____ YES NO

REGION 3

PROJECT DONE BEFORE _____

TOWN BUCKEFIELD

DATE _____

ROUTE OR 117 & 140

ACTUAL JOB TIME _____

ROAD NO. _____

PAVEMENT MARKINGS

Project No. _____

DESCRIPTION OF WORK DONE

Cambridge		Asset: 1002878
Total Sq. Feet: 37		Route 152 and Route 150
Stop Bar: 22		
Yield Bar: 15		Map: 31

DIAGRAM OF WORK

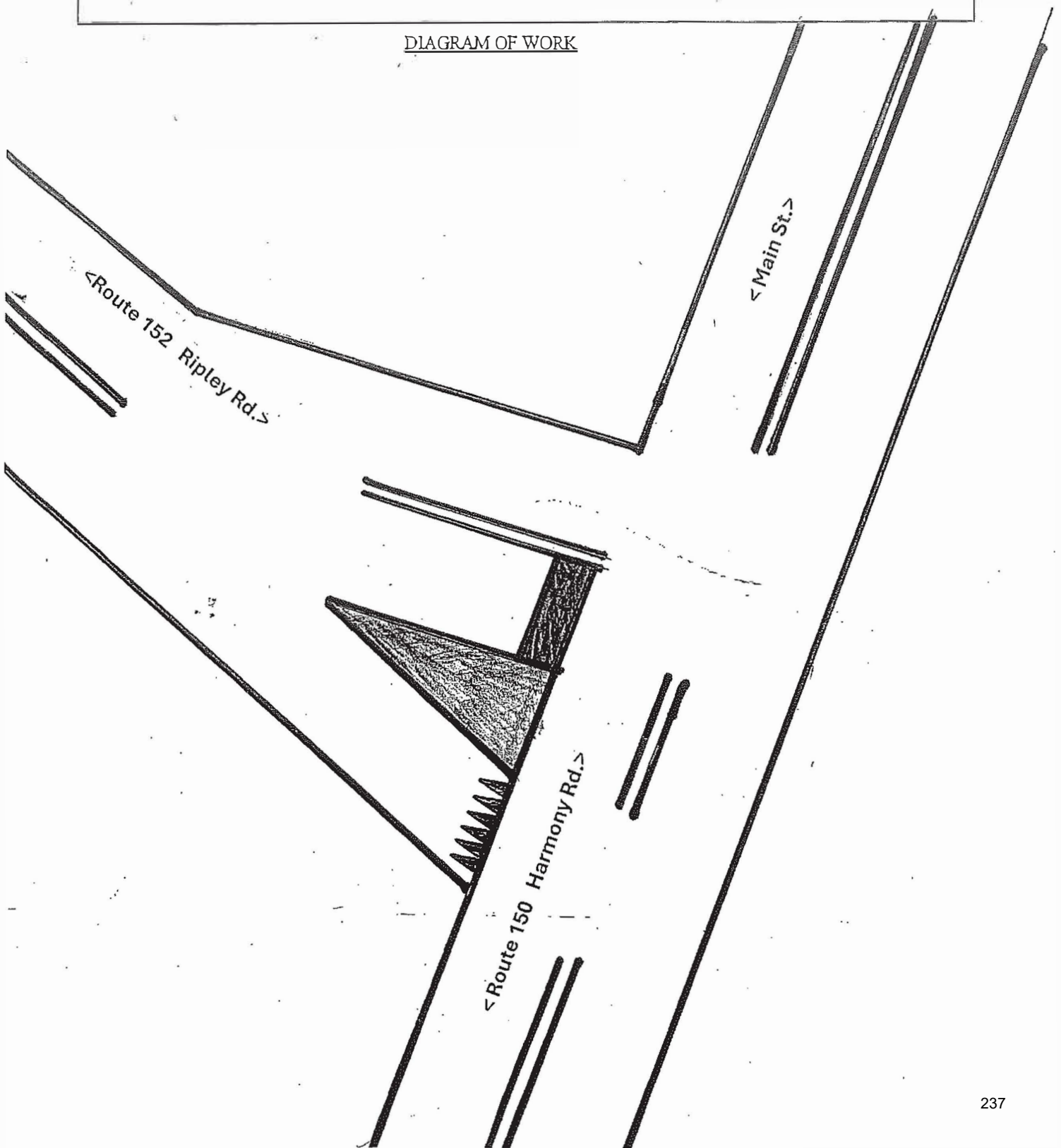

PAVEMENT MARKINGS

904981

Project No. _____

DESCRIPTION OF WORK DONE

STRAIGHT ARROW _____	LANE LINE _____
TURN ARROW _____	STOP _____
STOP BAR _____ 40	ONLY _____
CURBING-YELLOW _____	STOP AHEAD _____
WHITE _____	CROSSWALKS _____
HASH MARKS _____	TOTAL SQ. FT. _____ 40
MISC. _____	

DIAGRAM OF WORK

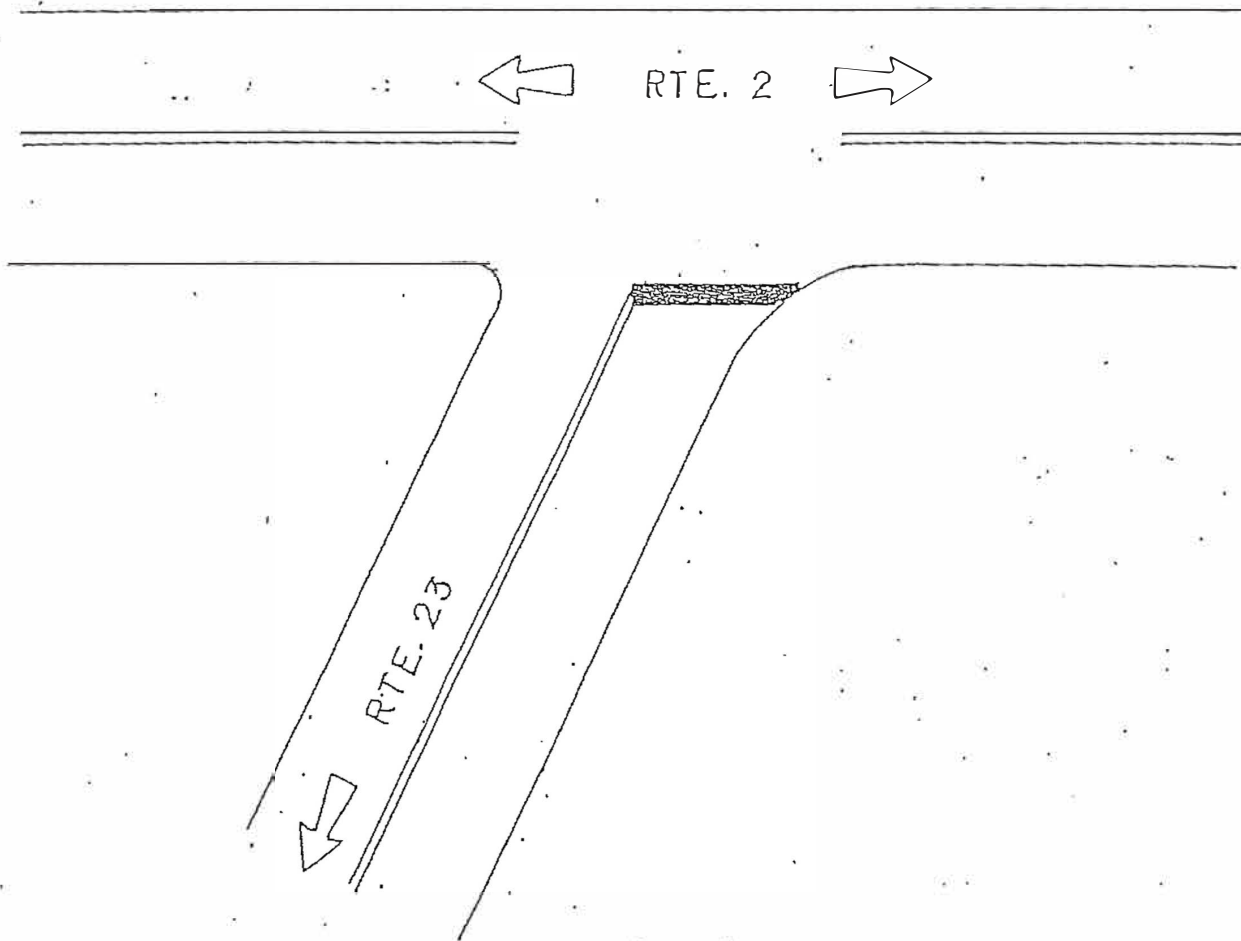

CREW LEADER _____
 YES NO
 PROJECT DONE BEFORE _____
 DATE _____
 ESTIMATE JOB TIME _____

REGION 3

TOWN CANAAN
 ROUTE OR 2 & 23
 ROAD NO. _____

PAVEMENT MARKINGS

Project No. _____

DESCRIPTION OF WORK DONE

Cannan		Asset: 1080857
Total Sq. Feet: 54		Route 23 and Route 2
Stop Bar: 54		Map: 21

DIAGRAM OF WORK

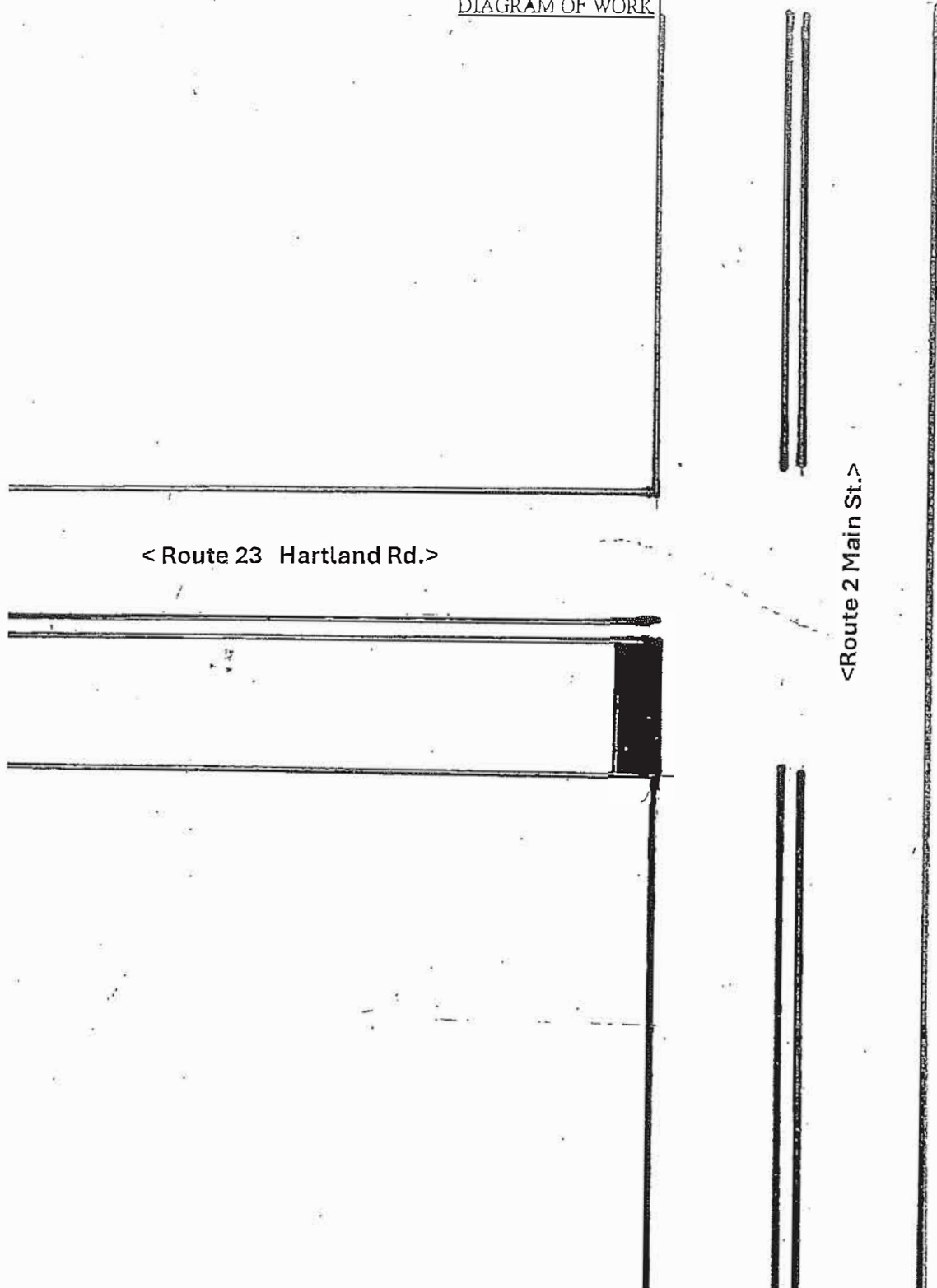

PAVEMENT MARKINGS

Project No. 904983

DESCRIPTION OF WORK DONE

STRAIGHT ARROW _____	LANE LINE _____
TURN ARROW _____	STOP _____
STOP BAR <u>80</u>	ONLY _____
CURBING-YELLOW _____	STOP AHEAD <u>74</u>
WHITE _____	CROSSWALKS _____
HASH MARKS _____	TOTAL SQ. FT. <u>154</u>
MISC. _____	

DIAGRAM OF WORK

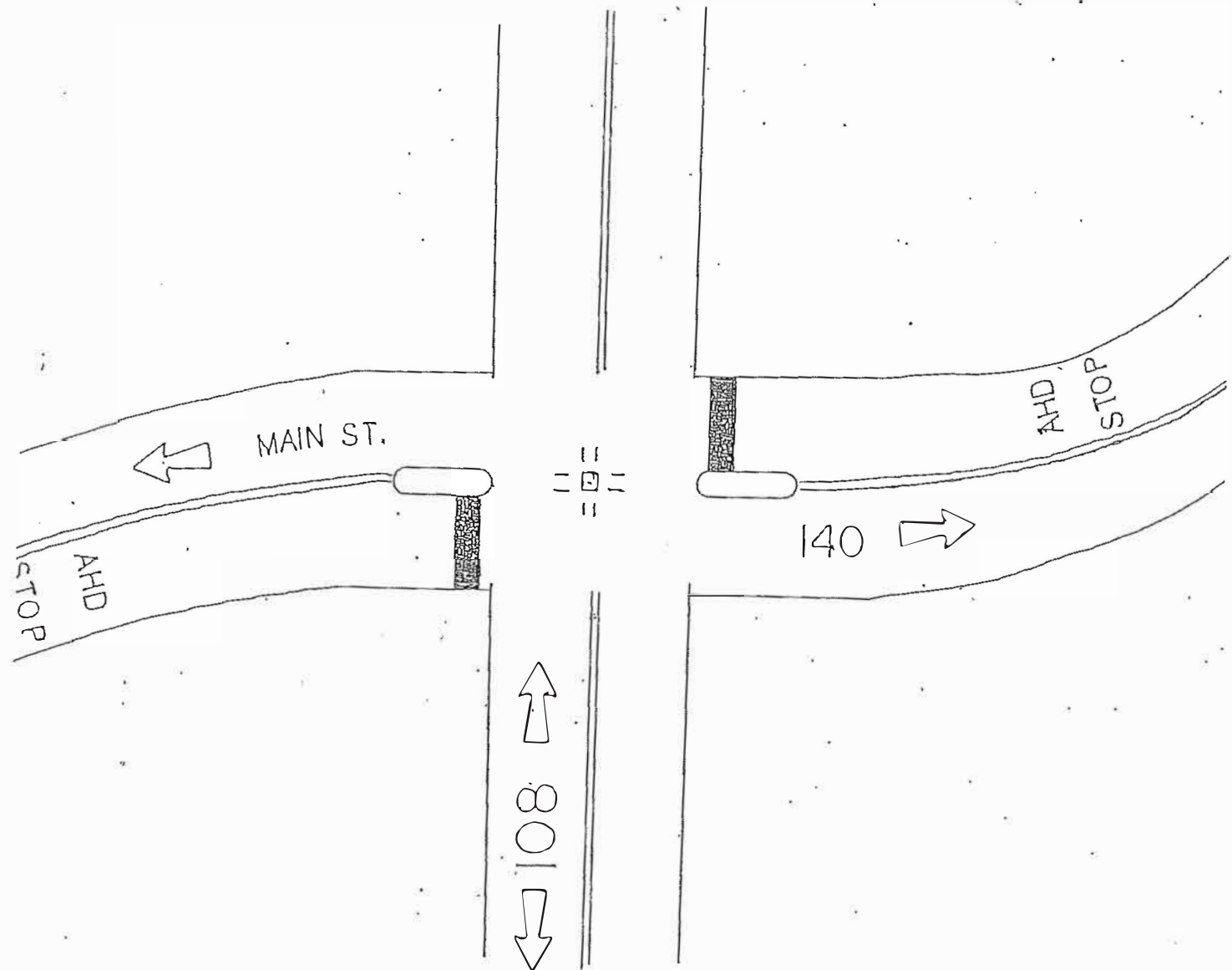

CREW LEADER _____
 YES NO
 PROJECT DONE BEFORE _____
 DATE _____
 ACTUAL JOB TIME _____

REGION 3
 TOWN CANTON
 ROUTE OR 108 & 140 & MAIN ST.
 ROAD NO: _____

PAVEMENT MARKINGS

Project No. _____

DESCRIPTION OF WORK DONE

Chesterville		Asset: 1038805
Total Sq. Feet: 60		Route 156 and Route 41
Stop Bar: 60		Map: 20

DIAGRAM OF WORK

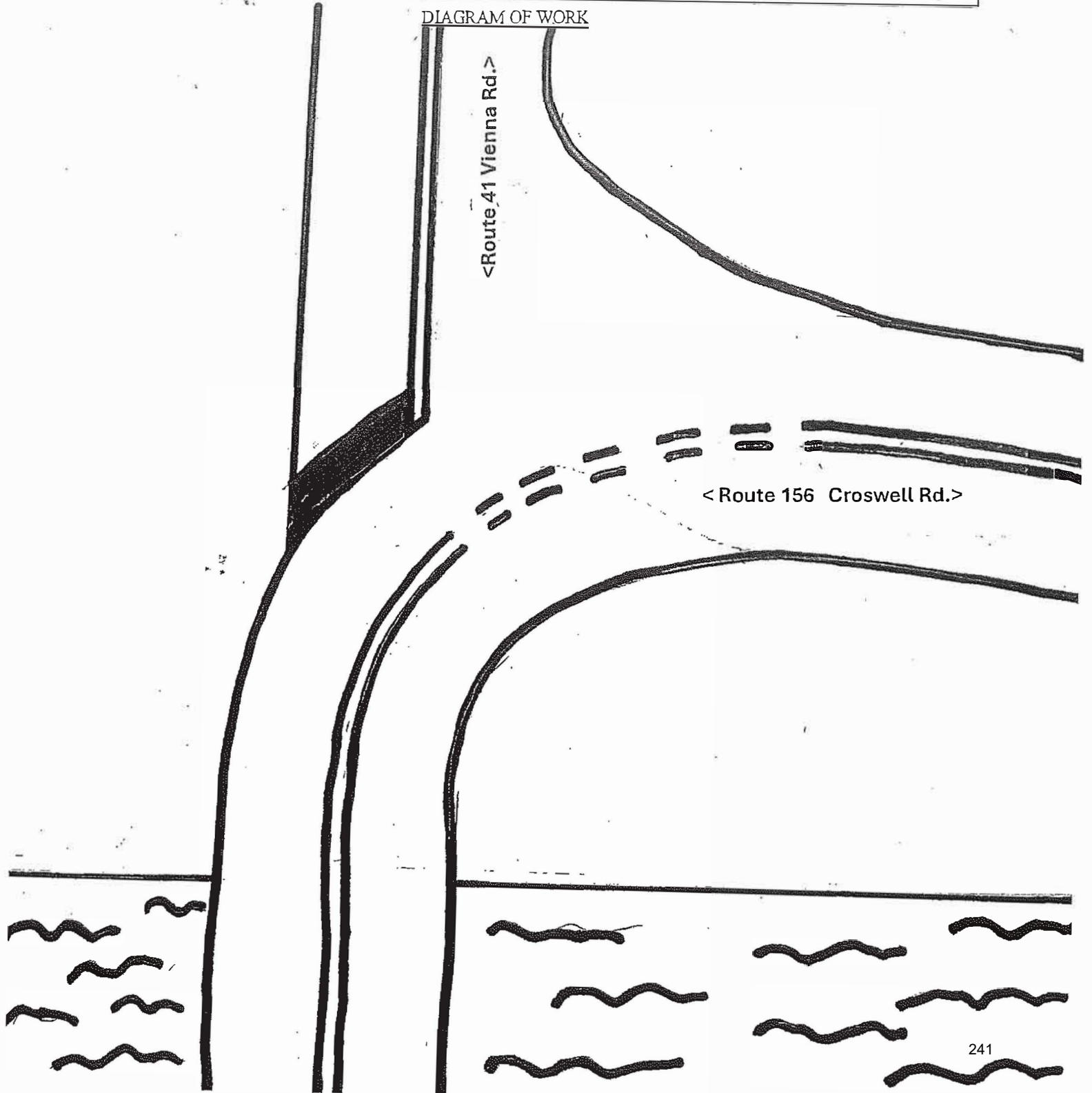

PAVEMENT MARKINGS

Project No. _____

DESCRIPTION OF WORK DONE

Cornville		Asset: 1038790
Total Sq. Feet: 62		Route 43 and Route 150
Stop Bar: 62		Map: 21

DIAGRAM OF WORK

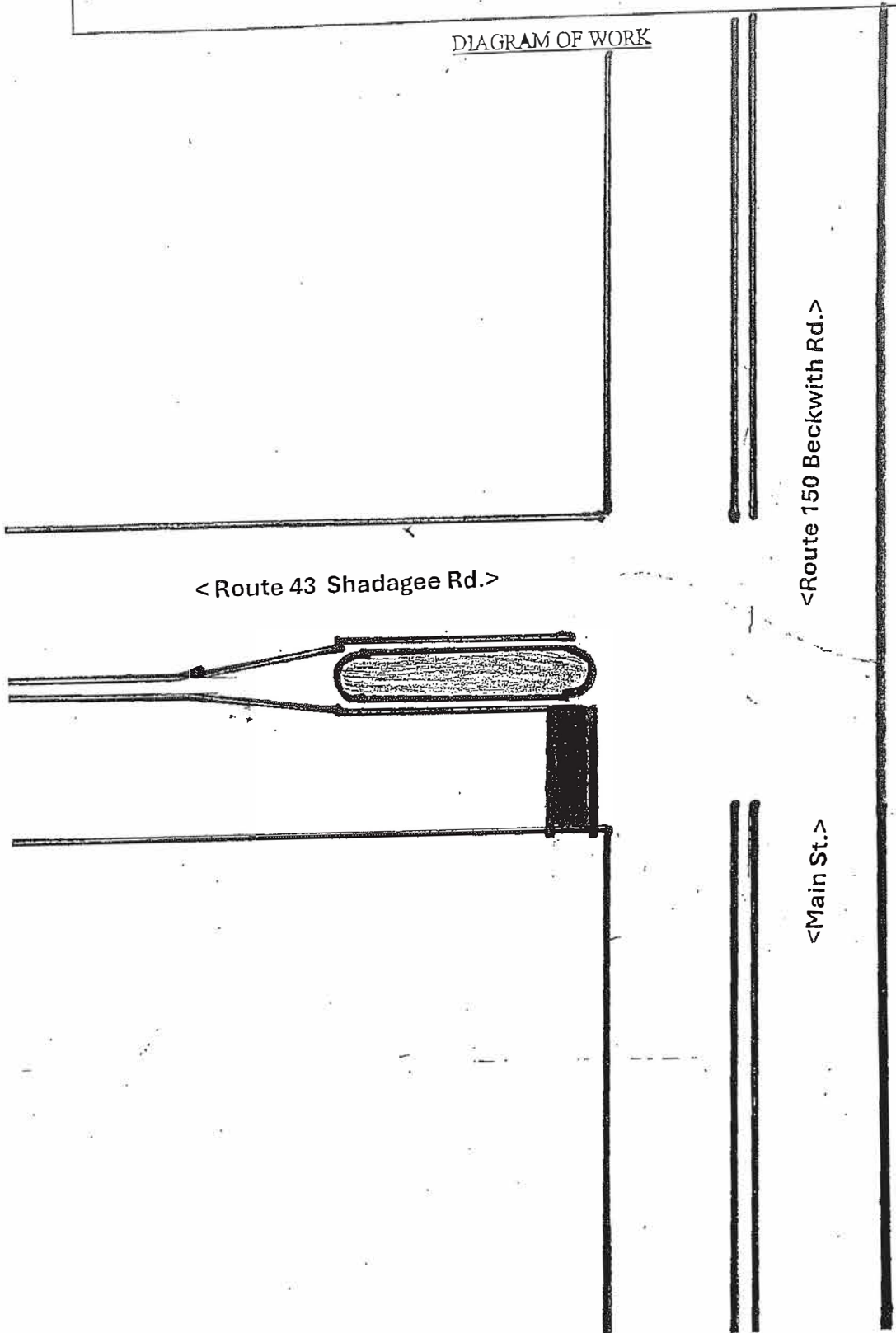

PAVEMENT MARKINGS

904987

Project No. _____

DESCRIPTION OF WORK DONE

STRAIGHT ARROW _____	LANE LINE _____
TURN ARROW _____ 32	STOP _____
STOP BAR _____ 140	ONLY _____
CURBING-YELLOW _____	STOP AHEAD _____
WHITE _____	CROSSWALKS _____
HASH MARKS _____ 25	TOTAL SQ. FT. 197
MISC. _____	

DIAGRAM OF WORK

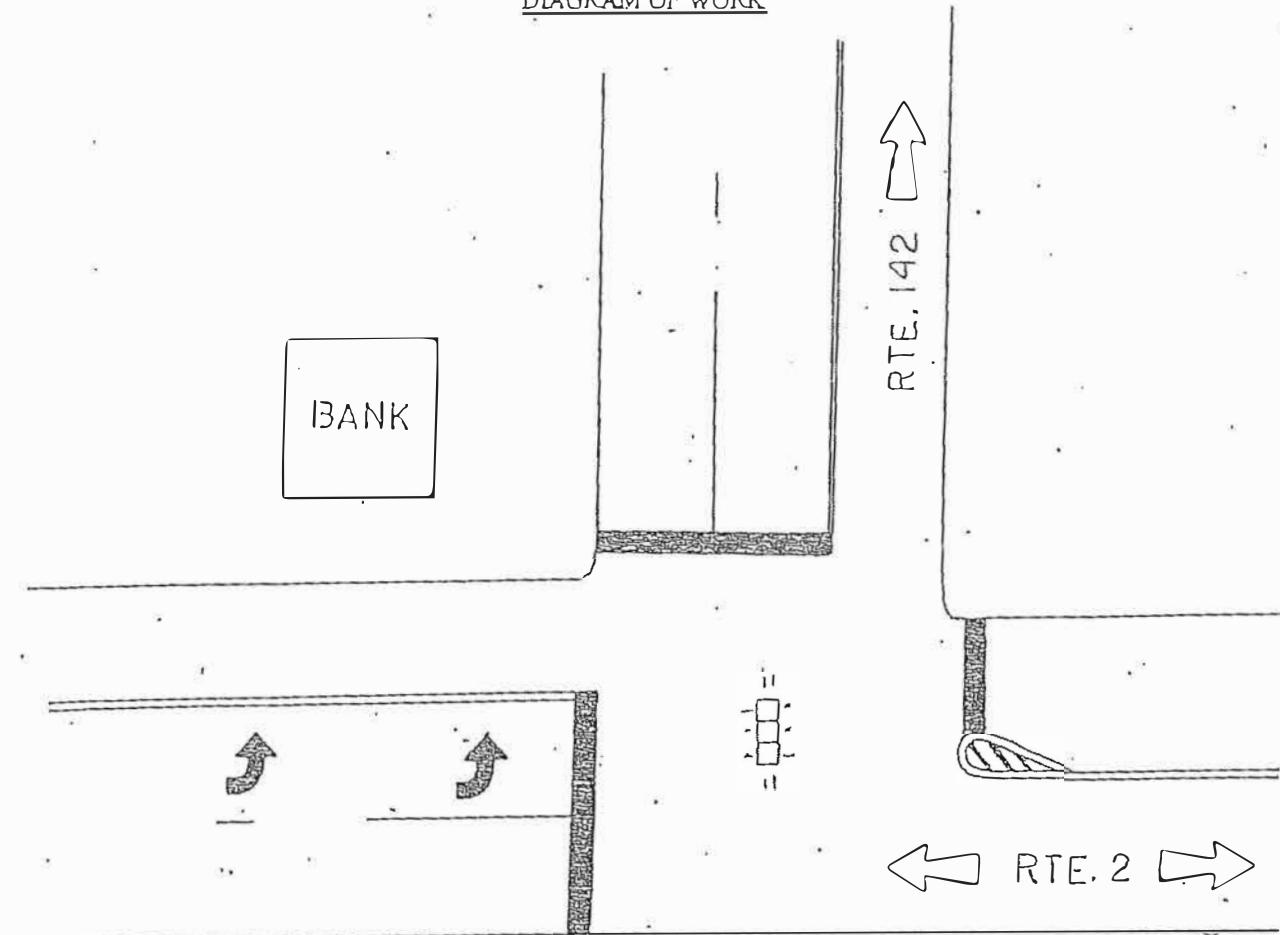

CREW LEADER _____
PROJECT DONE BEFORE _____ YES NO
DATE _____
ACTUAL JOB TIME _____

REGION 3

TOWN DIXFIELD
ROUTE OR 2 & 142
ROAD NO.

PAVEMENT MARKINGS

Project No. _____

DESCRIPTION OF WORK DONE

Eustis	Asset: 1081168
Total Sq. Feet: 52	Route 16 and Route 27
Stop Bar: 52	Map: 21

DIAGRAM OF WORK

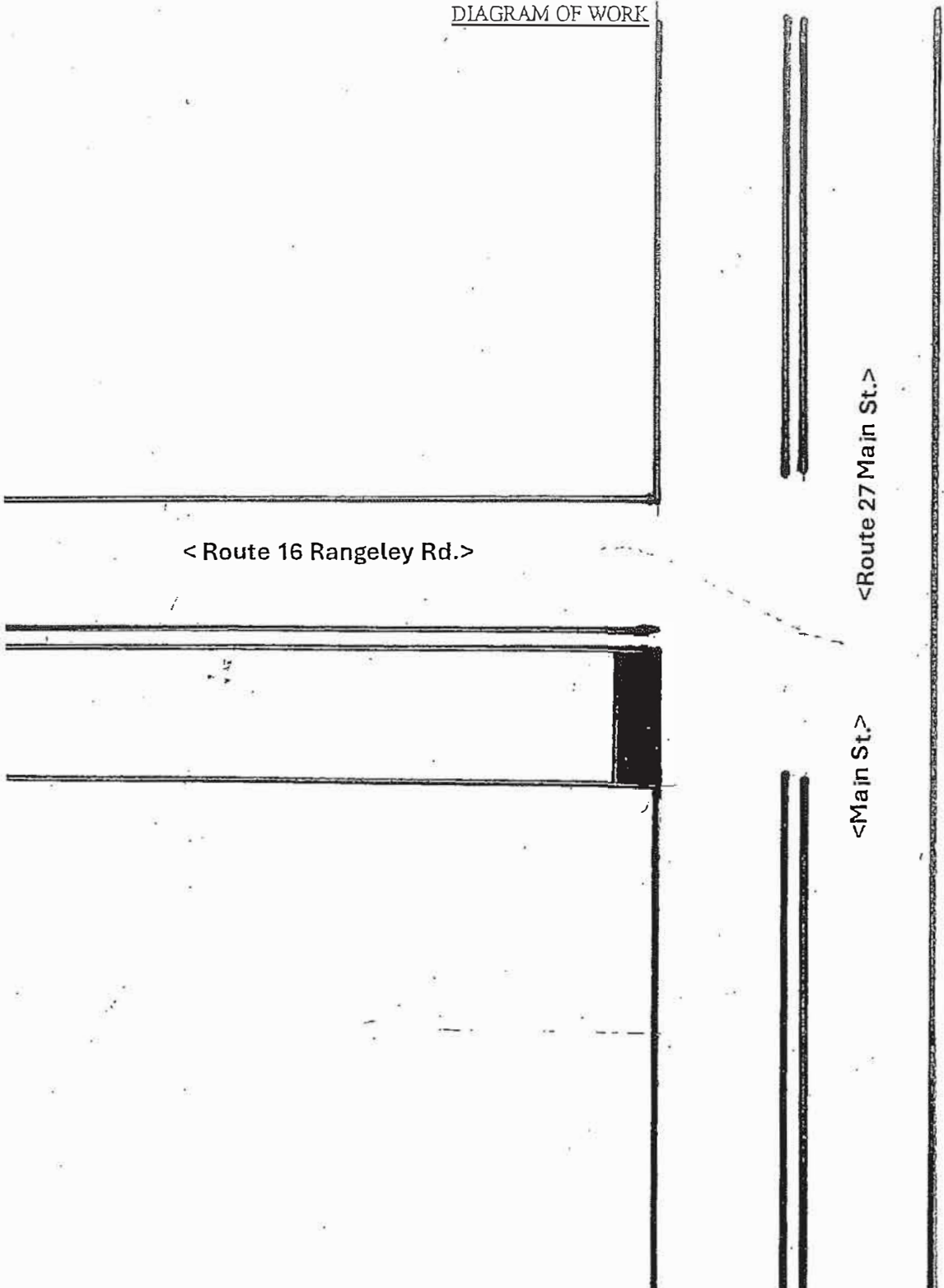

PAVEMENT MARKINGS

Project No. 904989

DESCRIPTION OF WORK DONE

STRAIGHT ARROW _____	LANE LINE _____
TURN ARROW _____	STOP _____
STOP BAR _____ <u>80</u>	ONLY _____
CURBING-YELLOW _____ <u>60</u>	STOP AHEAD _____ <u>37</u>
WHITE _____	CROSSWALKS _____
HASH MARKS _____	TOTAL SQ. FT. _____ <u>17.7</u>
MISC. _____	

DIAGRAM OF WORK

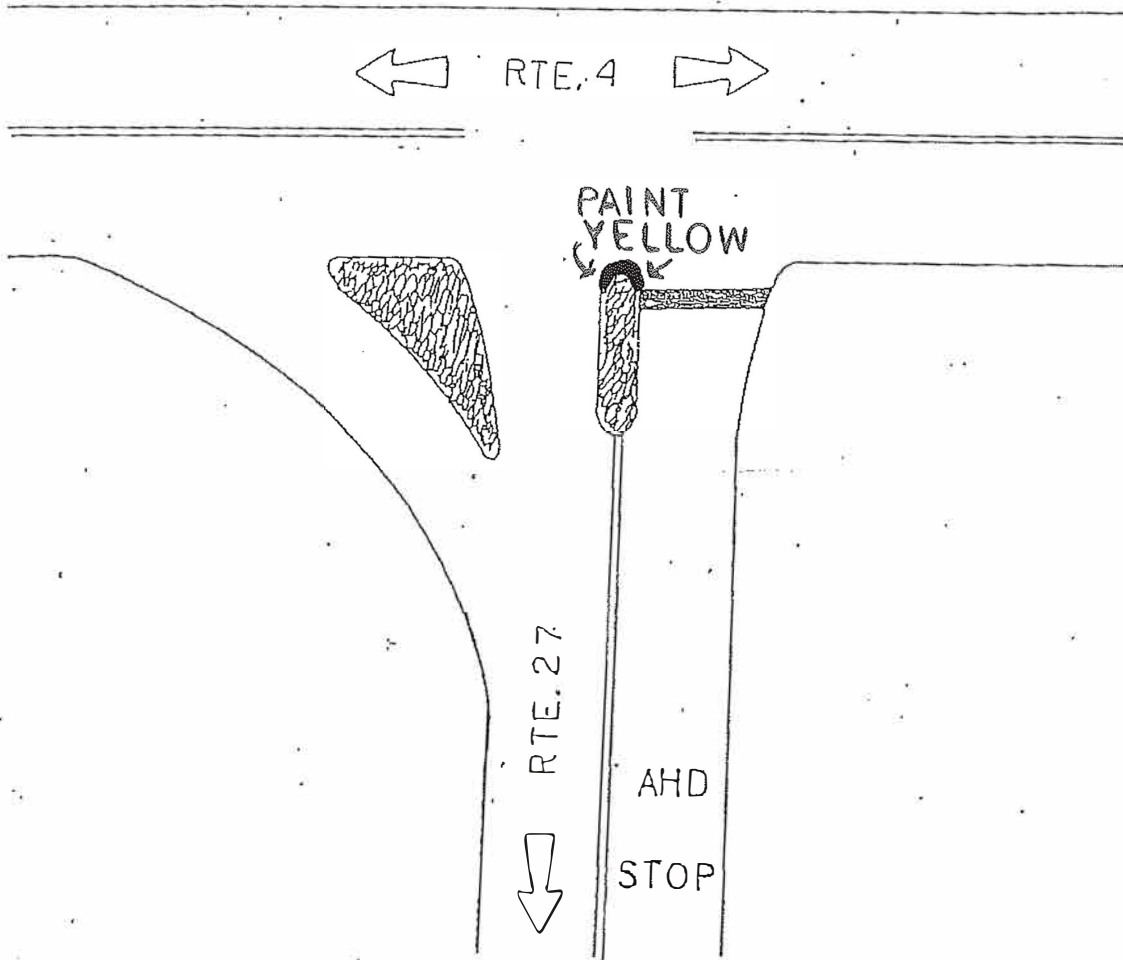

CREW LEADER _____

YES

PROJECT DONE BEFORE _____

DATE _____

ACTUAL JOB TIME _____

REGION 3

TOWN FARMINGTON

ROUTE OR 4&27

ROAD NO. _____

PAVEMENT MARKINGS

Project No. 905087

DESCRIPTION OF WORK DONE

STRAIGHT ARROW _____	LANE LINE _____
TURN ARROW _____	STOP _____ <u>22</u>
STOP BAR _____ <u>46</u>	ONLY _____
CURBING-YELLOW _____	STOP AHEAD _____ <u>39</u>
WHITE _____	CROSSWALKS _____
HASH MARKS _____	TOTAL SQ. FT. _____ <u>107</u>
MISC. _____	

DIAGRAM OF WORK

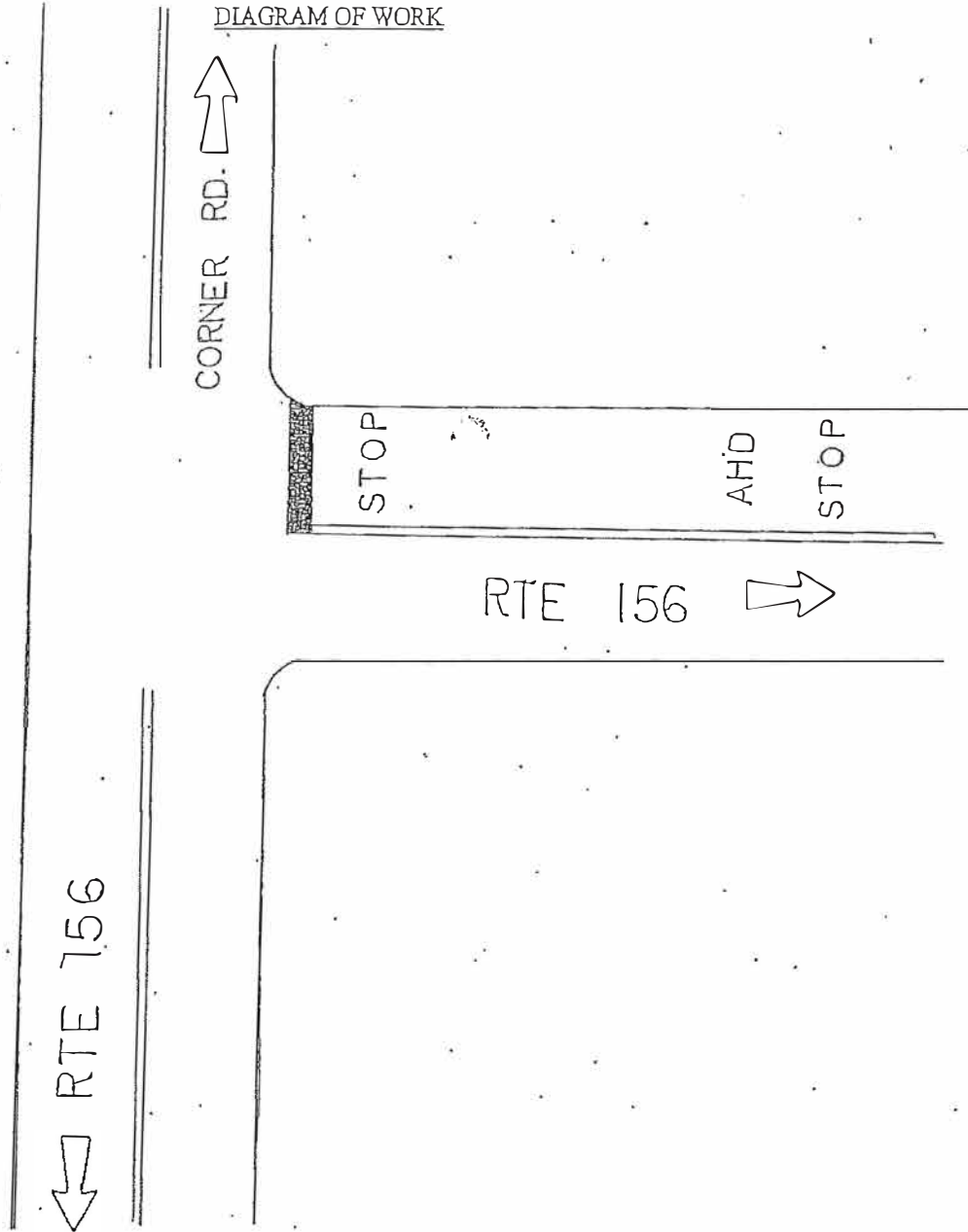

CREW LEADER _____

REGION 3

YES NO

PROJECT DONE BEFORE _____

DATE _____

ACTUAL JOB TIME _____

TOWN FARMINGTON
ROUTE OR 156 & CORNER RD.
ROAD NO.

PAVEMENT MARKINGS

Project No. _____

DESCRIPTION OF WORK DONE

Farmington		Asset: 1038802
Total Sq. Feet:	45	Route 41 and Route 2
Stop Bar:	45	Map: 20

DIAGRAM OF WORK

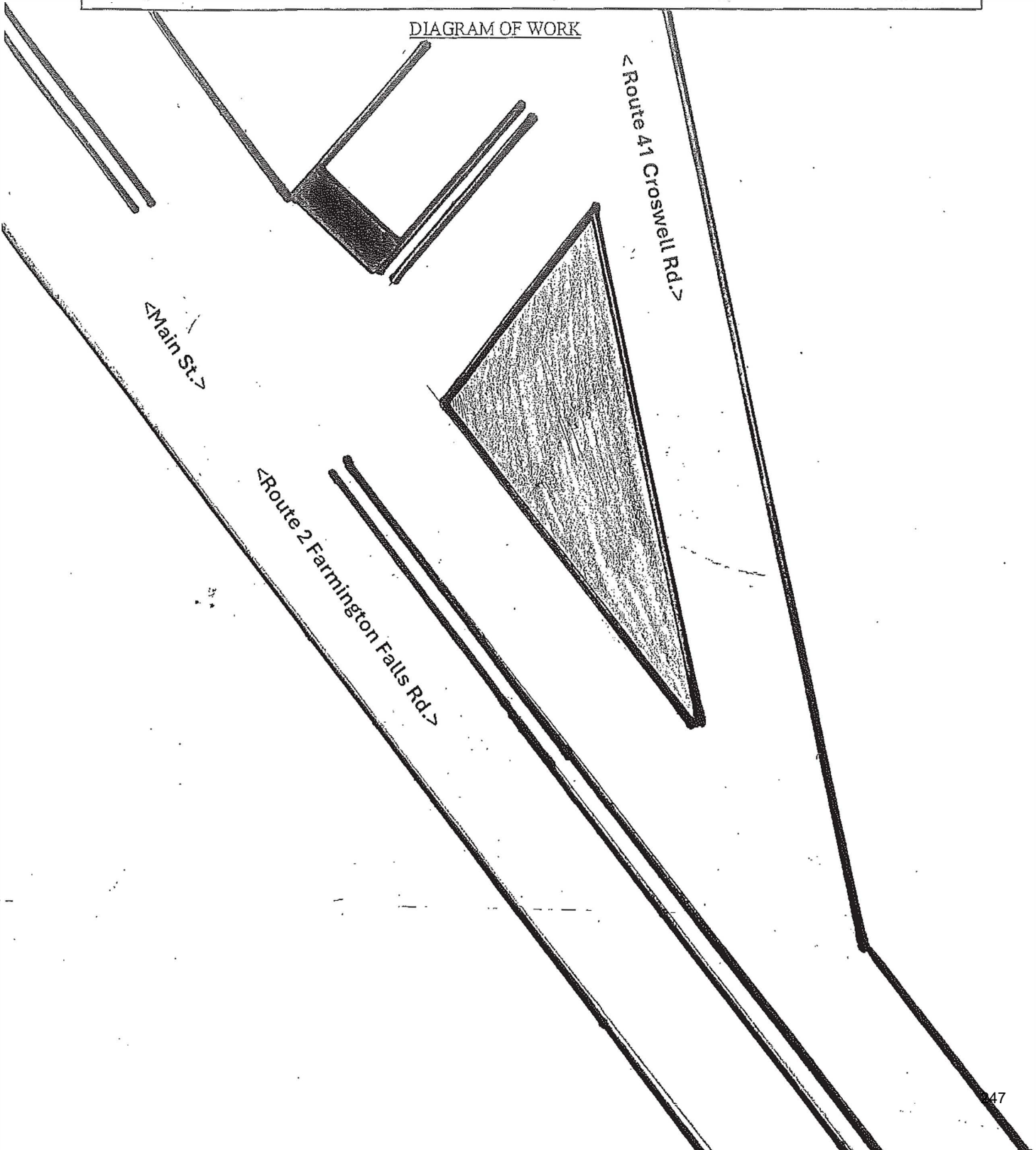

PAVEMENT MARKINGS

Project No. _____

DESCRIPTION OF WORK DONE

Freeman TWP

Asset: 1038832

Total Sq. Feet: 75

Route 145 and Route 142

Stop Bar: 75

Map: 29

DIAGRAM OF WORK

<Route 145 Foster Hill Rd.>

<Route 142 Salem Rd.>

PAVEMENT MARKINGS

Project No. _____

DESCRIPTION OF WORK DONE

<u>Harmony</u>		<u>Asset:</u>	<u>1002865</u>
Total Sq. Feet:	51	Route 154 and Route 150	
Stop Bar:	36	Map:	31
Yield Bar:	15		

DIAGRAM OF WORK

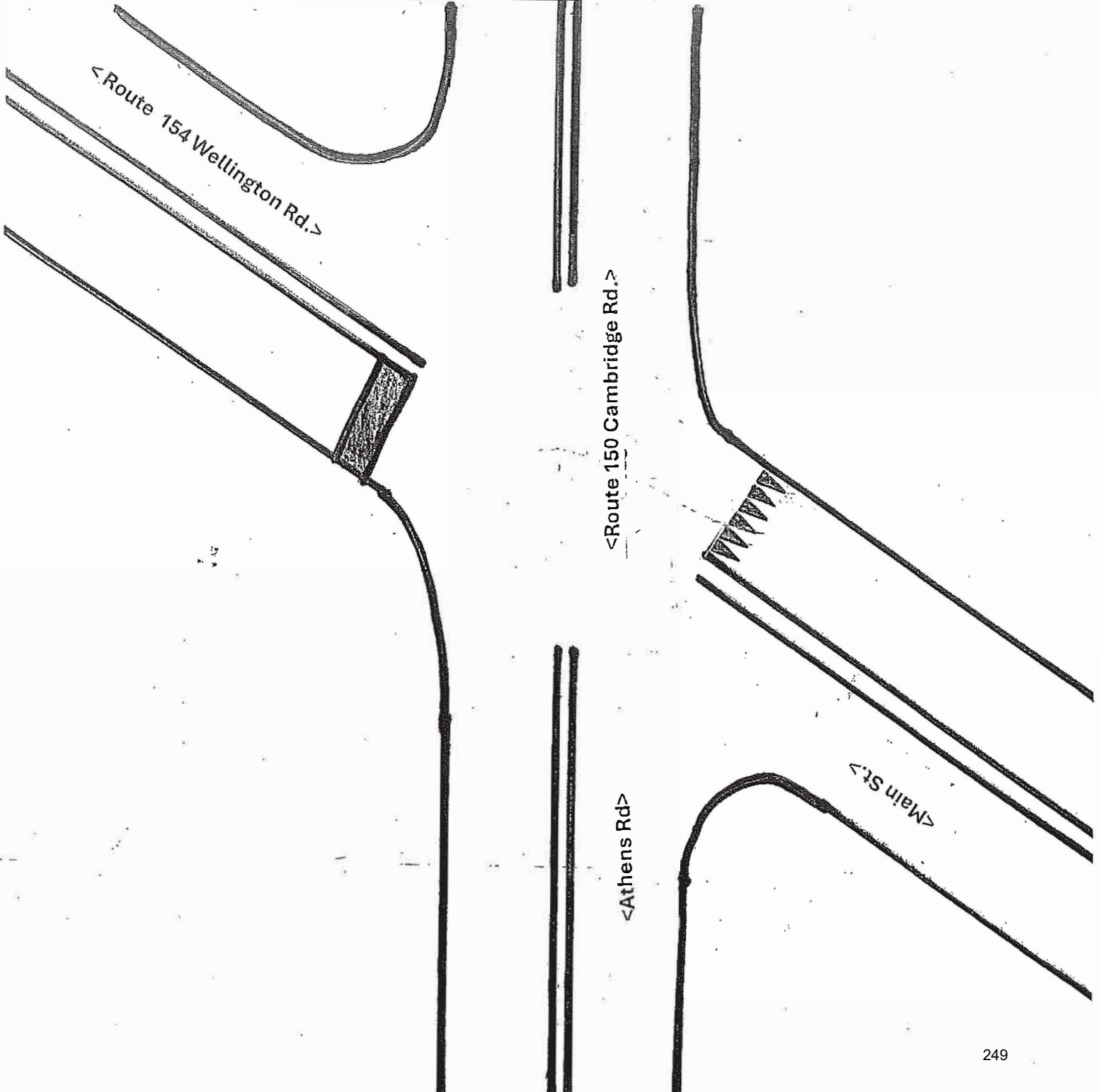

PAVEMENT MARKINGS

Project No. _____

DESCRIPTION OF WORK DONE

Hartland		Asset: 1080853
Total Sq. Feet:	20	Route 151 and Route 23
Stop Bar:	20	Map: 21

DIAGRAM OF WORK

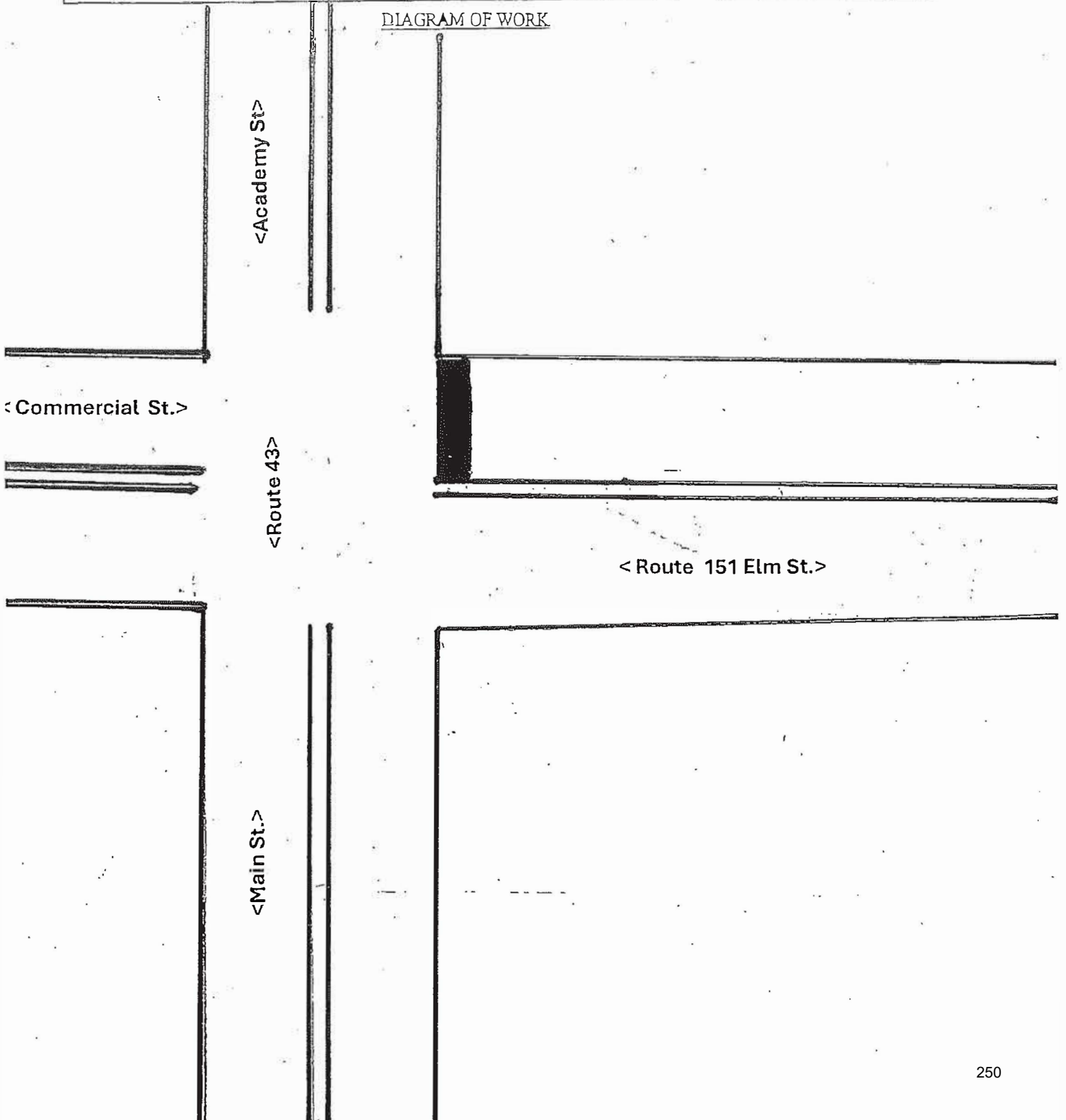

PAVEMENT MARKINGS

Project No. _____

DESCRIPTION OF WORK DONE

Hartland		Asset: 1080855
Total Sq. Feet:	44	Route 152 and Route 23
Stop Bar:	44	Map: 21

DIAGRAM OF WORK

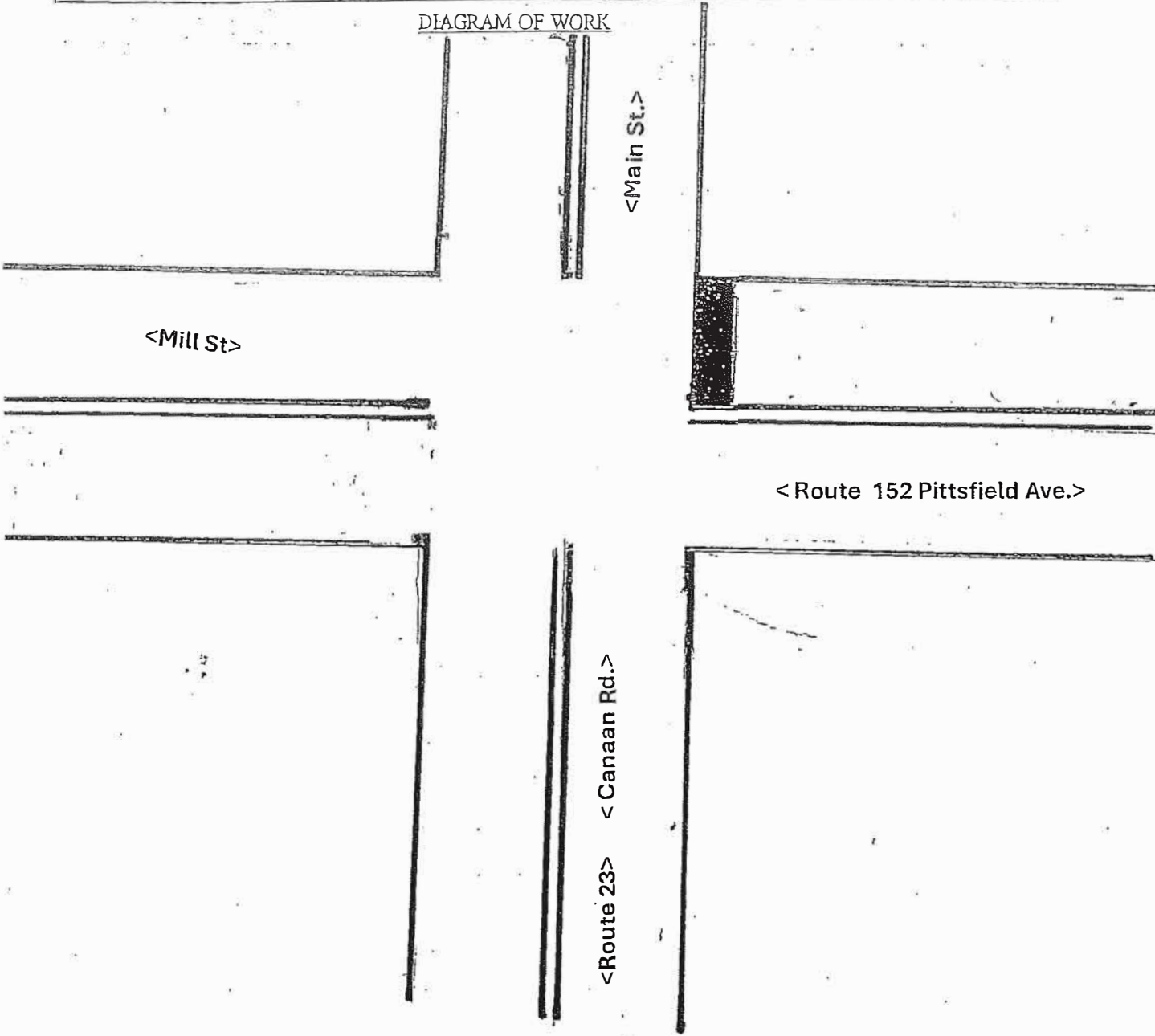

CREW LEADER _____
 YES NO
 PROJECT DONE BEFORE _____
 DATE _____
 ACTUAL JOB TIME _____

DIVISION _____
 TOWN _____
 ROUTE OR _____
 ROAD NO. _____

PAVEMENT MARKINGS

Project No. _____

DESCRIPTION OF WORK DONE

<u>Industry</u>		Asset: 1038796
Total Sq. Feet:	60	Route 148 and Route 43
Stop Bar:	60	Map: 20

DIAGRAM OF WORK

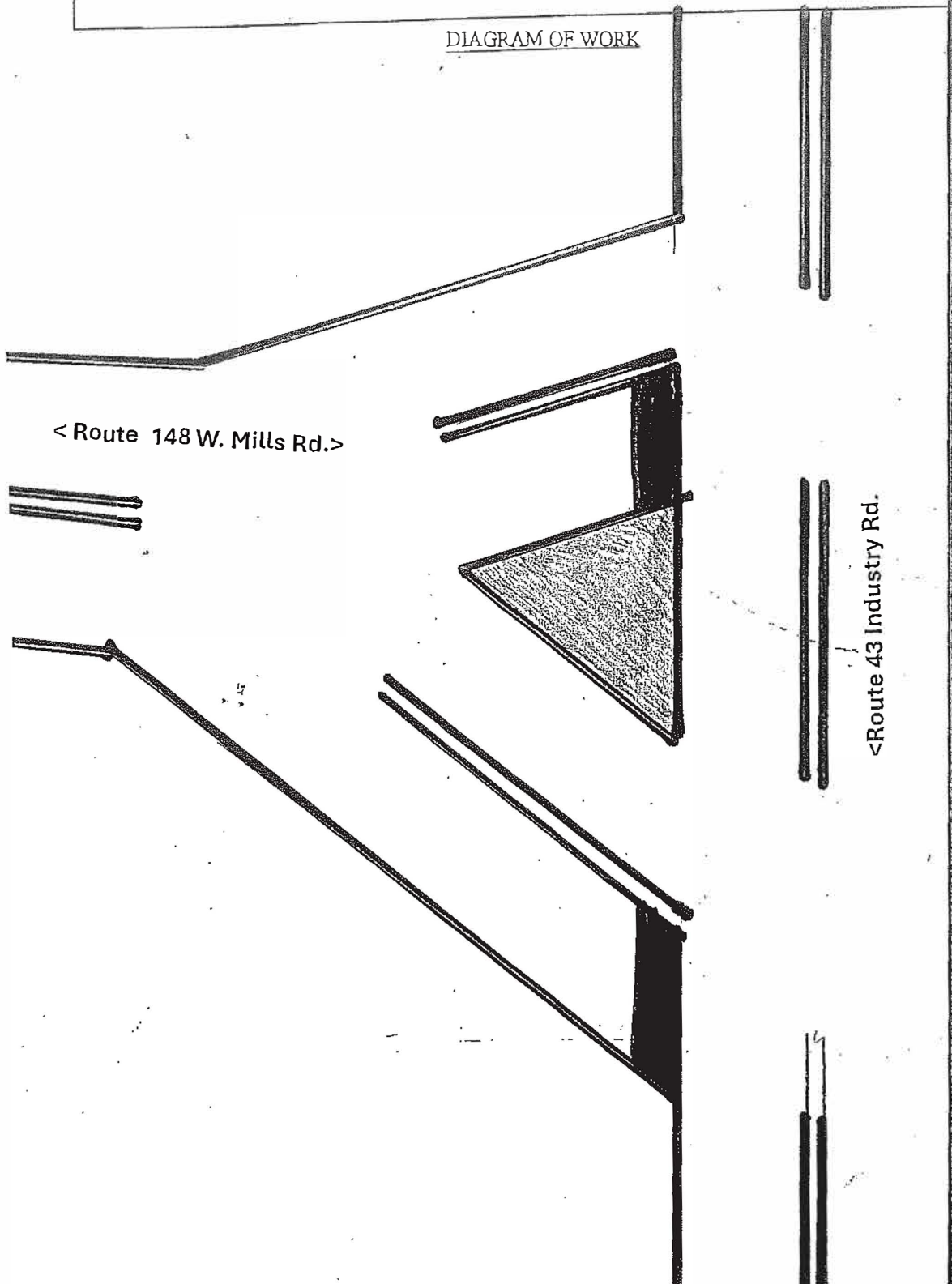

PAVEMENT MARKINGS

Project No. _____

DESCRIPTION OF WORK DONE

Jay _____

Asset: 905030

Total Sq. Feet: 986

Stop Bar: 136

White Hash: 86

Stop: 88

Chevrons: 466

Stop AHD: 148

35 MPH: 62

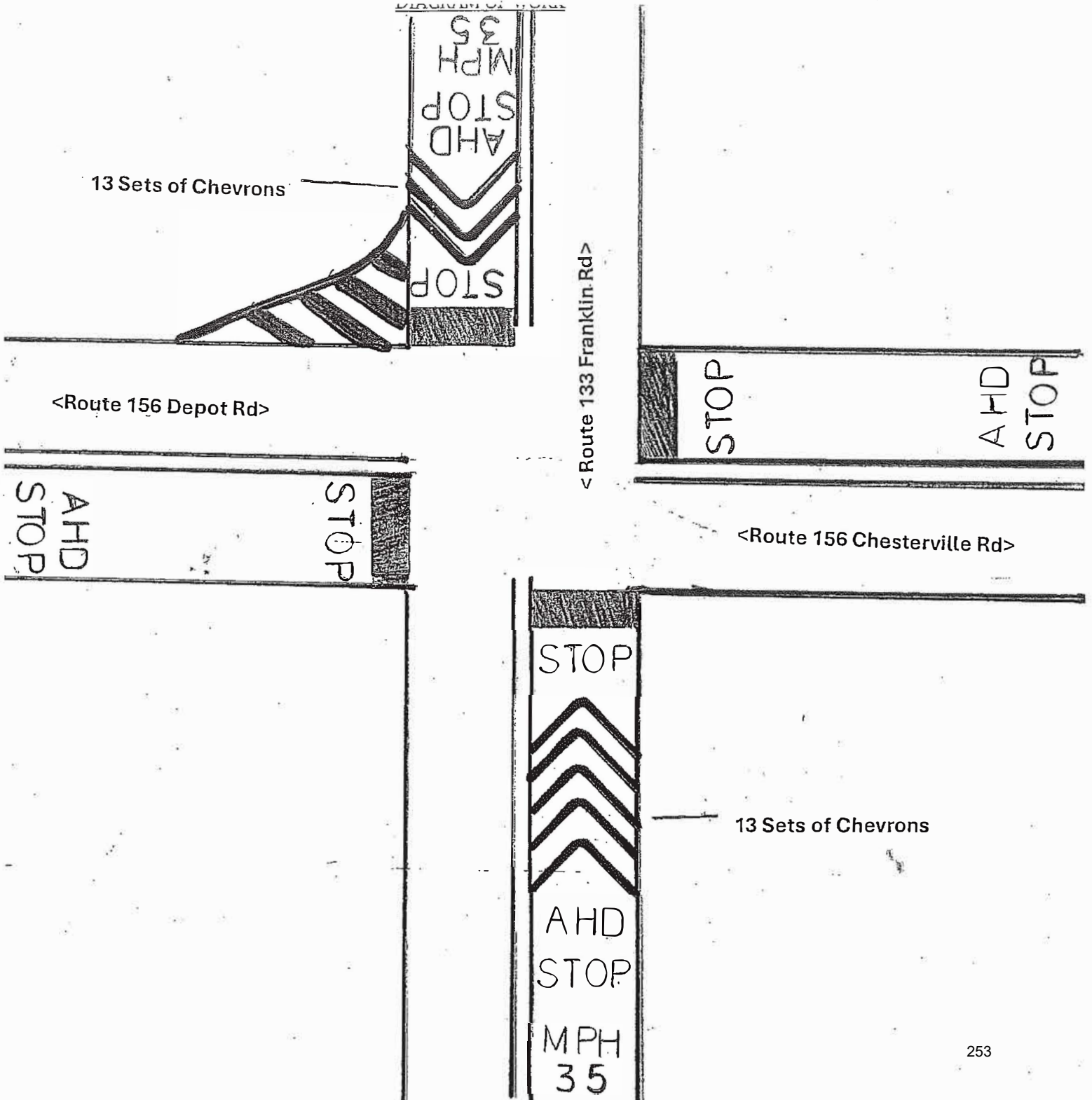

PAVEMENT MARKINGS

905026

Project No. _____

DESCRIPTION OF WORK DONE

STRAIGHT ARROW. 78
 TURN ARROW 112
 STOP BAR 200
 CURBING-YELLOW _____
 WHITE _____
 HASH MARKS _____
 MISC. COMB ARROW 87

LANE LINE _____
 STOP _____
 ONLY _____
 STOP-AHEAD _____
 CROSSWALKS _____
 TOTAL SQ. FT. 477

DIAGRAM OF WORK

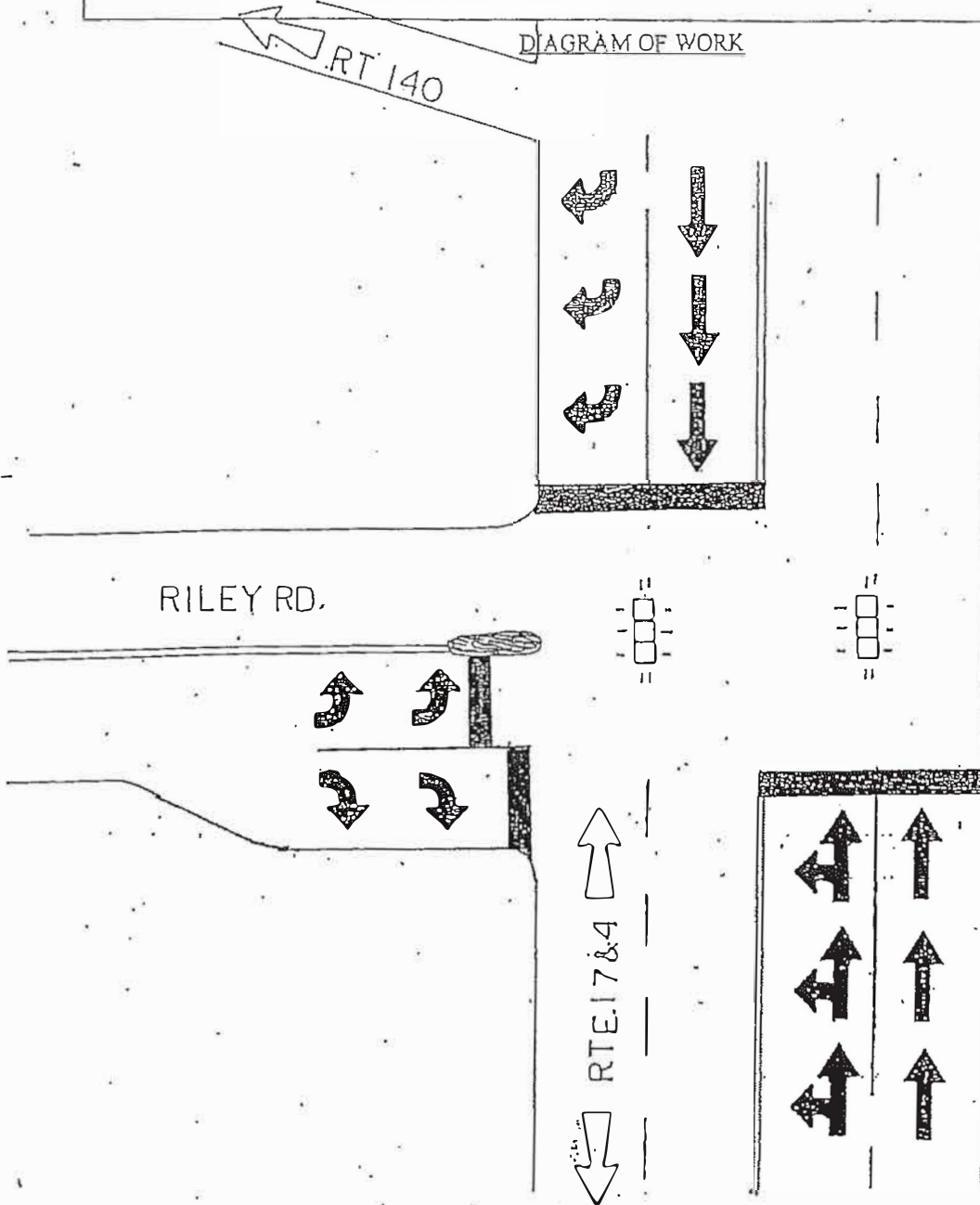

CREW LEADER _____ YES NO

PROJECT DONE BEFORE _____
DATE _____

ACTUAL JOB TIME _____

REGION 2

TOWN JAY
ROUTE OR 4 & 17 &

ROAD NO. RILEY RD.

PAVEMENT MARKINGS

905028

Project No. _____

DESCRIPTION OF WORK DONE

STRAIGHT ARROW _____	LANE LINE _____
TURN ARROW _____	STOP _____
STOP BAR _____	ONLY _____
CURBING-YELLOW _____	STOP AHEAD _____
WHITE _____	CROSSWALKS _____
HASH MARKS _____	TOTAL SQ. FT. <u>86</u>
MISC. _____	

DIAGRAM OF WORK

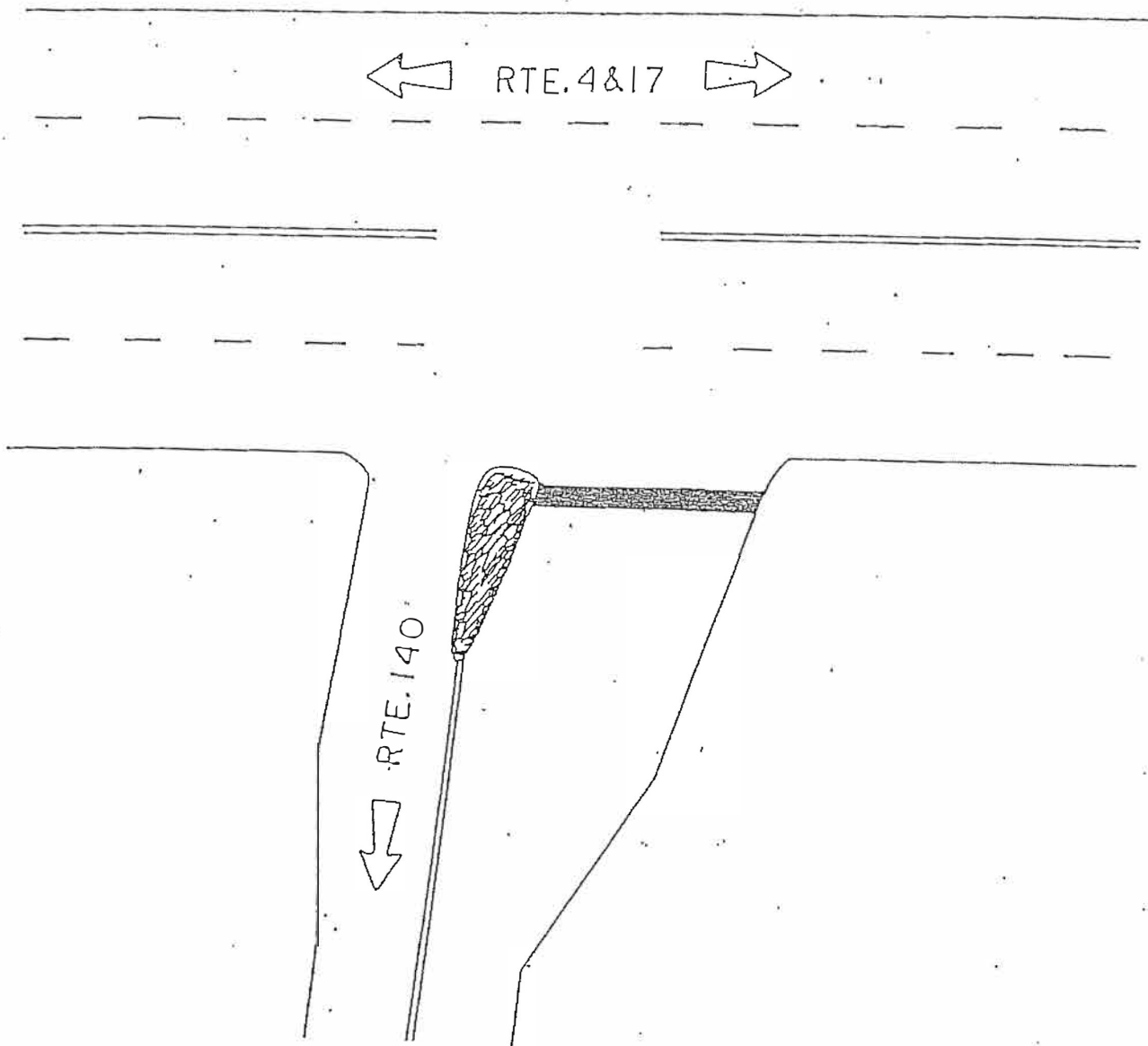

CREW LEADER _____ YES NO
 PROJECT DONE BEFORE _____
 DATE _____
 ACTUAL JOB TIME _____

REGION 3
 TOWN JAY
 ROUTE OR 4&17&140
 ROAD NO. _____

PAVEMENT MARKINGS

Project No. 905032

DESCRIPTION OF WORK DONE

STRAIGHT ARROW _____	LANE LINE _____
TURN ARROW _____	STOP <u>22</u>
STOP BAR <u>40</u>	ONLY _____
CURBING-YELLOW _____	STOP AHEAD _____
WHITE _____	CROSSWALKS _____
HASH MARKS _____	TOTAL SQ. FT. <u>62</u>
MISC. _____	

DIAGRAM OF WORK

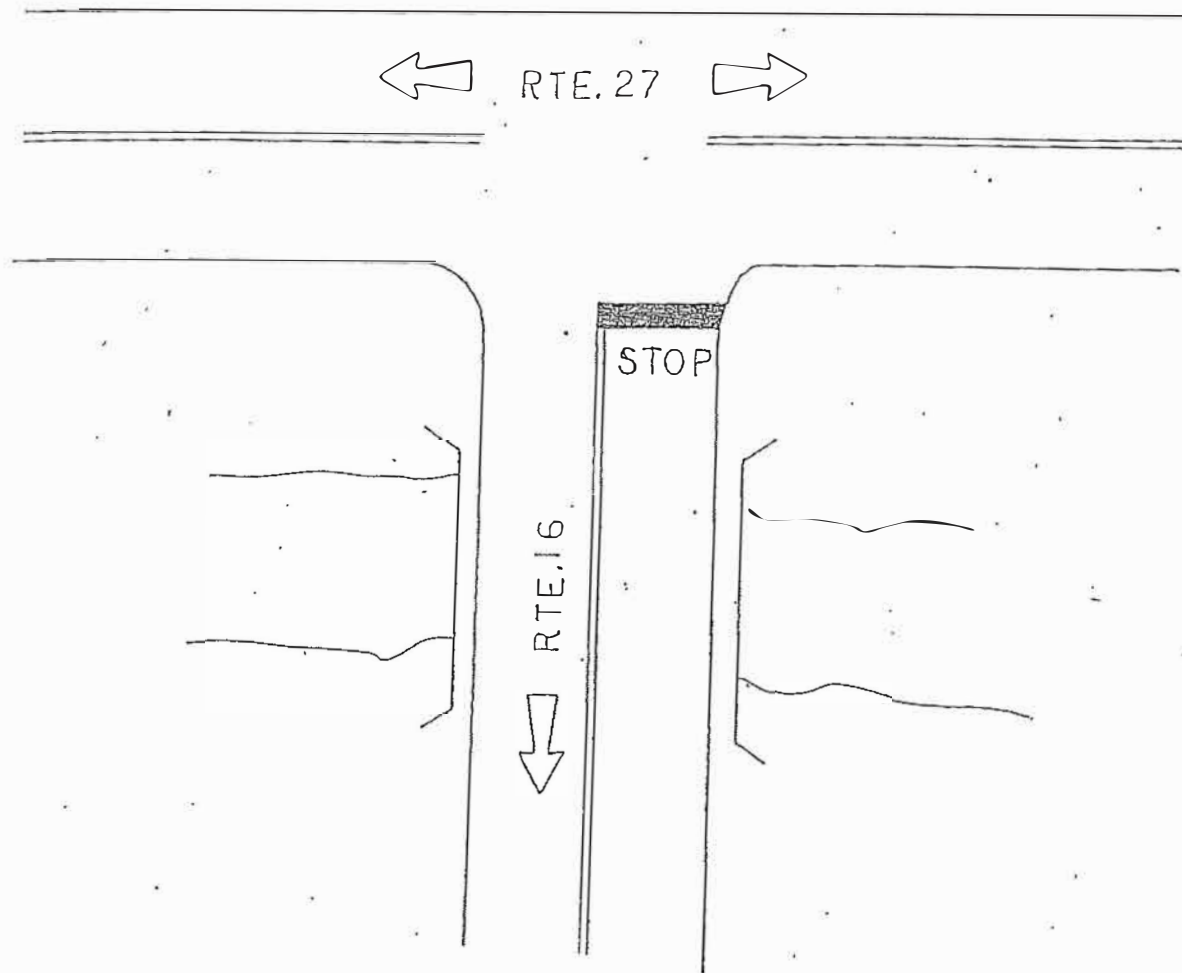

CREW LEADER _____
 YES NO
 PROJECT DONE BEFORE _____
 DATE _____
 ACTUAL JOB TIME _____

REGION 3
 TOWN KINGFIELD
 ROUTE OR 16 & 27
 ROAD NO. _____

PAVEMENT MARKINGS

Project No. 905034

DESCRIPTION OF WORK DONE

STRAIGHT ARROW _____	LANE LINE _____
TURN ARROW _____	STOP _____
STOP BAR <u>88</u> _____	ONLY _____
CURBING-YELLOW _____	STOP AHEAD _____
WHITE _____	CROSSWALKS _____
HASH MARKS _____	TOTAL SQ. FT. <u>88</u> _____
MISC. _____	

DIAGRAM OF WORK

QUIK
STOP

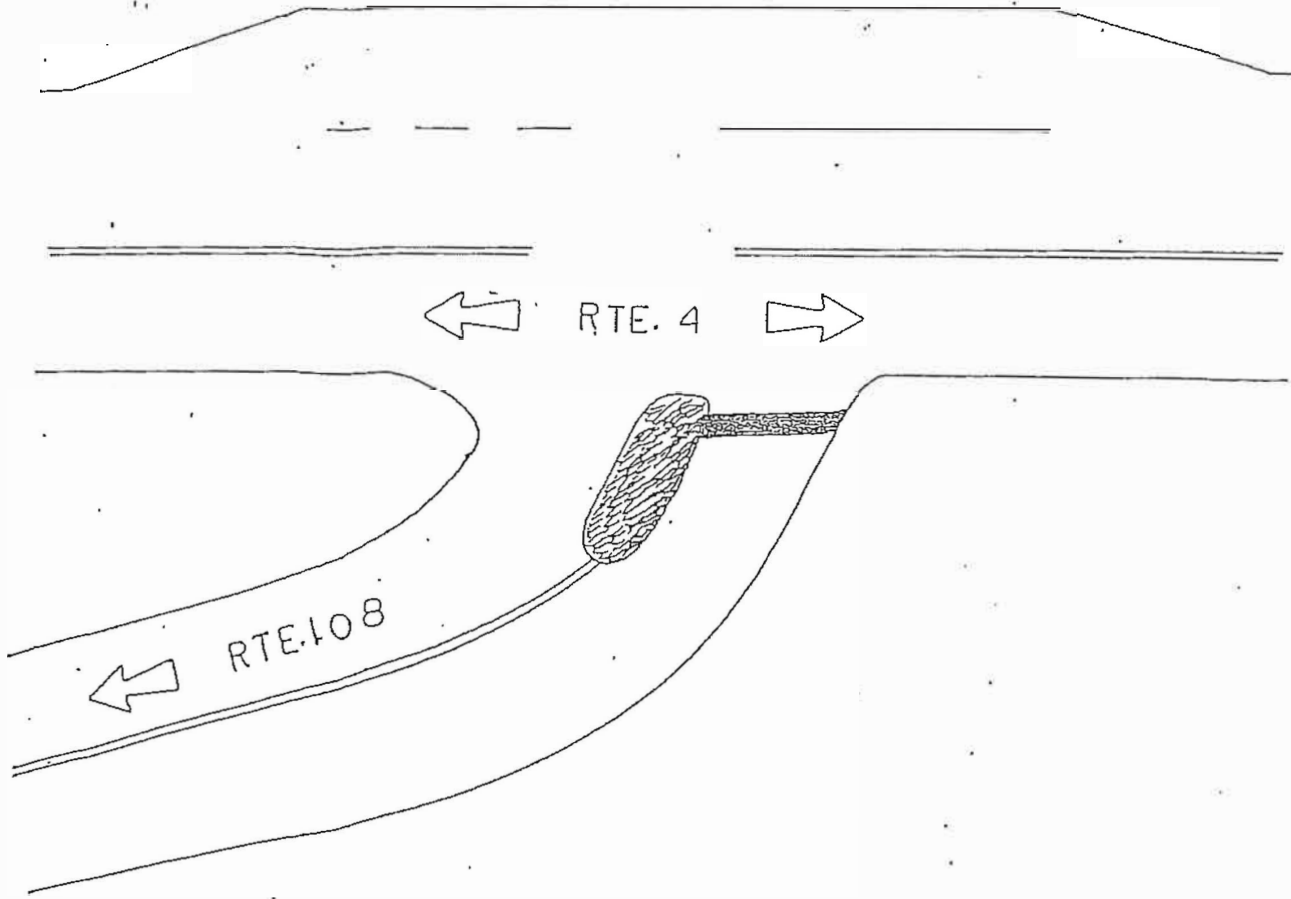

CREW LEADER _____
YES NO
PROJECT DONE BEFORE _____
DATE _____
ACTUAL JOB TIME _____

REGION 3
TOWN LIVERMORE
ROUTE OR 4 & 108
ROAD NO. _____

PAVEMENT MARKINGS

Project No. 905038

DESCRIPTION OF WORK DONE

STRAIGHT ARROW	<u>13</u>	LANE LINE	<u>25</u>
TURN ARROW	<u>80</u>	STOP	_____
STOP BAR	_____	ONLY	_____
CURBING-YELLOW	_____	STOP AHEAD	_____
WHITE	_____	CROSSWALKS	_____
HASH MARKS	_____	TOTAL SQ. FT.	<u>143</u>
MISC. <u>YIELD</u>	<u>25</u>		

DIAGRAM OF WORK

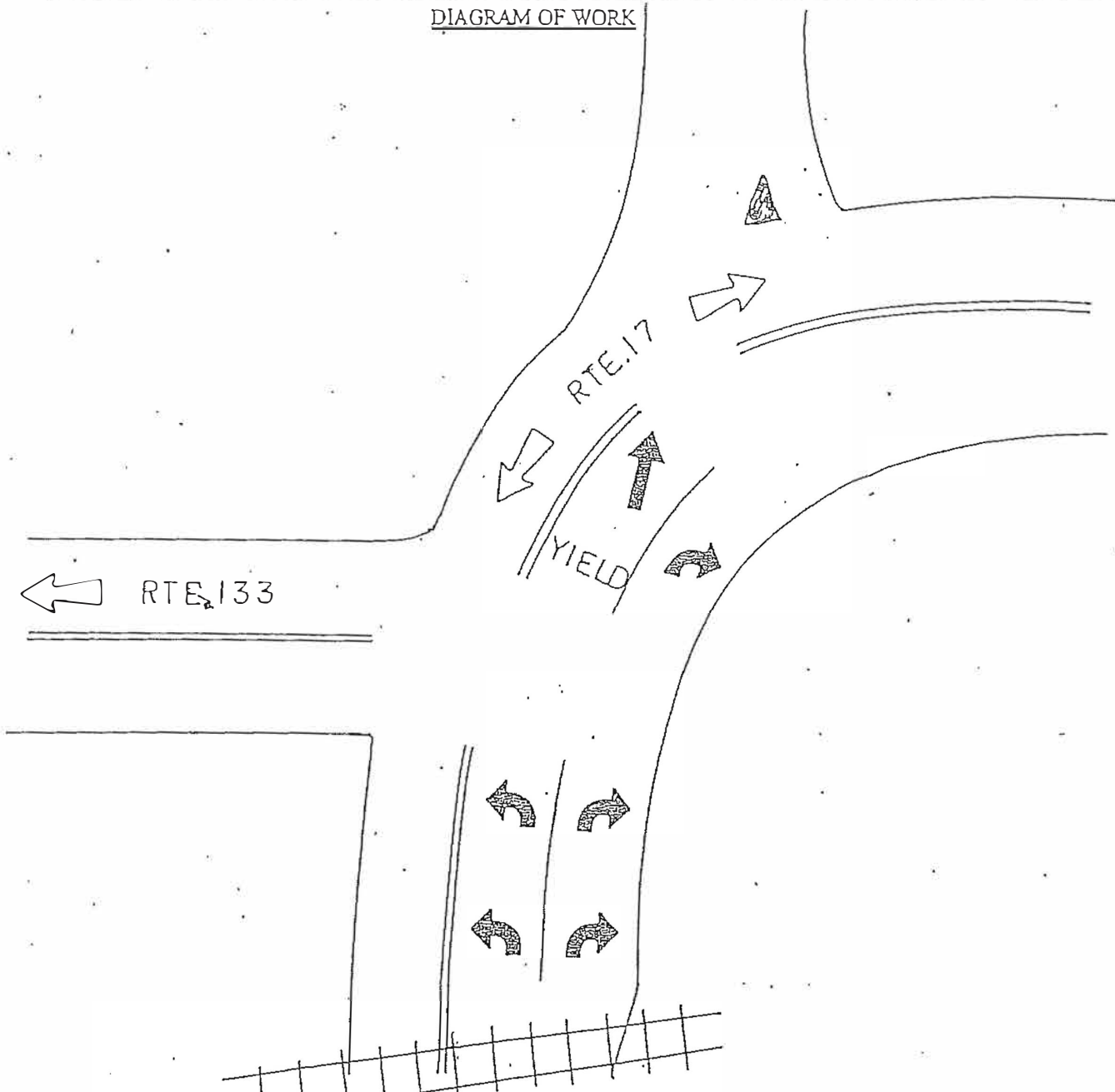

CREW LEADER _____ YES NO

PROJECT DONE BEFORE _____
DATE _____
ACTUAL JOB TIME _____

REGION 3

TOWN LIVERMORE FALLS
ROUTE OR 17 & 133
ROAD NO. _____

PAVEMENT MARKINGS

Project No. 905052

DESCRIPTION OF WORK DONE

STRAIGHT ARROW _____	LANE LINE _____
TURN ARROW _____ <u>80</u>	STOP _____
STOP BAR _____ <u>152</u>	ONLY _____
CURBING-YELLOW _____	STOP AHEAD _____
WHITE _____	CROSSWALKS _____
HASH MARKS _____ <u>8</u>	TOTAL SQ. FT. <u>465</u>
MISC. COMBOS _____ <u>145</u>	

DIAGRAM OF WORK

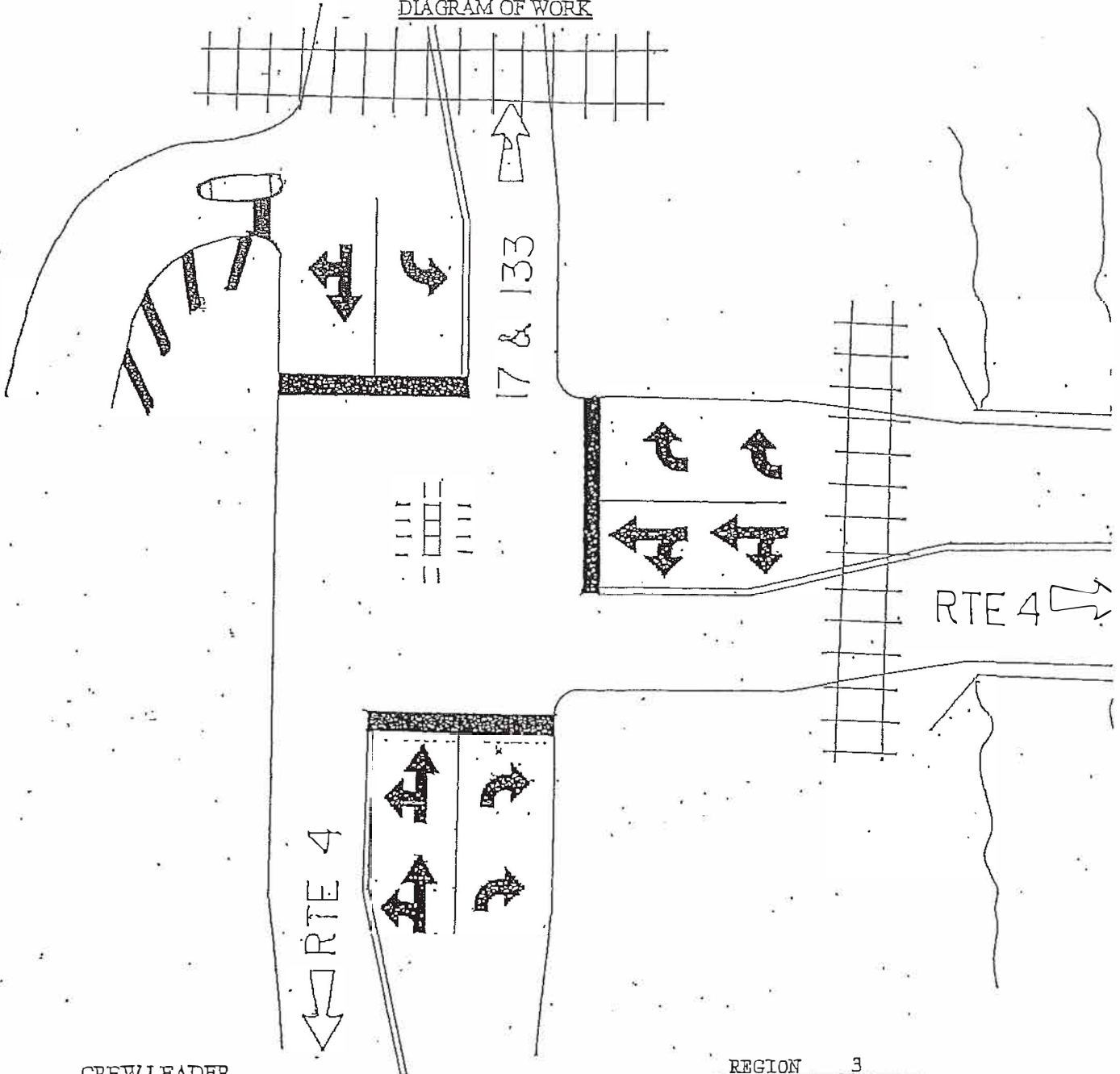

CREW LEADER _____
 PROJECT DONE BEFORE _____
 DATE _____
 ACTUAL JOB TIME _____

REGION 3

TOWN LIVERMORE FALLS
 ROUTE OR 4 & 17 & 133
 ROAD NO. _____

PAVEMENT MARKINGS

905054

Project No. _____

DESCRIPTION OF WORK DONE

STRAIGHT ARROW _____	LANE LINE _____
TURN ARROW _____	STOP _____
STOP BAR _____	ONLY _____
CURBING-YELLOW _____	STOP AHEAD _____
WHITE _____	CROSSWALKS _____
HASH MARKS _____	TOTAL SQ. FT. <u>158</u>
MISC. <u>WRONG WAY ARROWS 50</u>	

DIAGRAM OF WORK

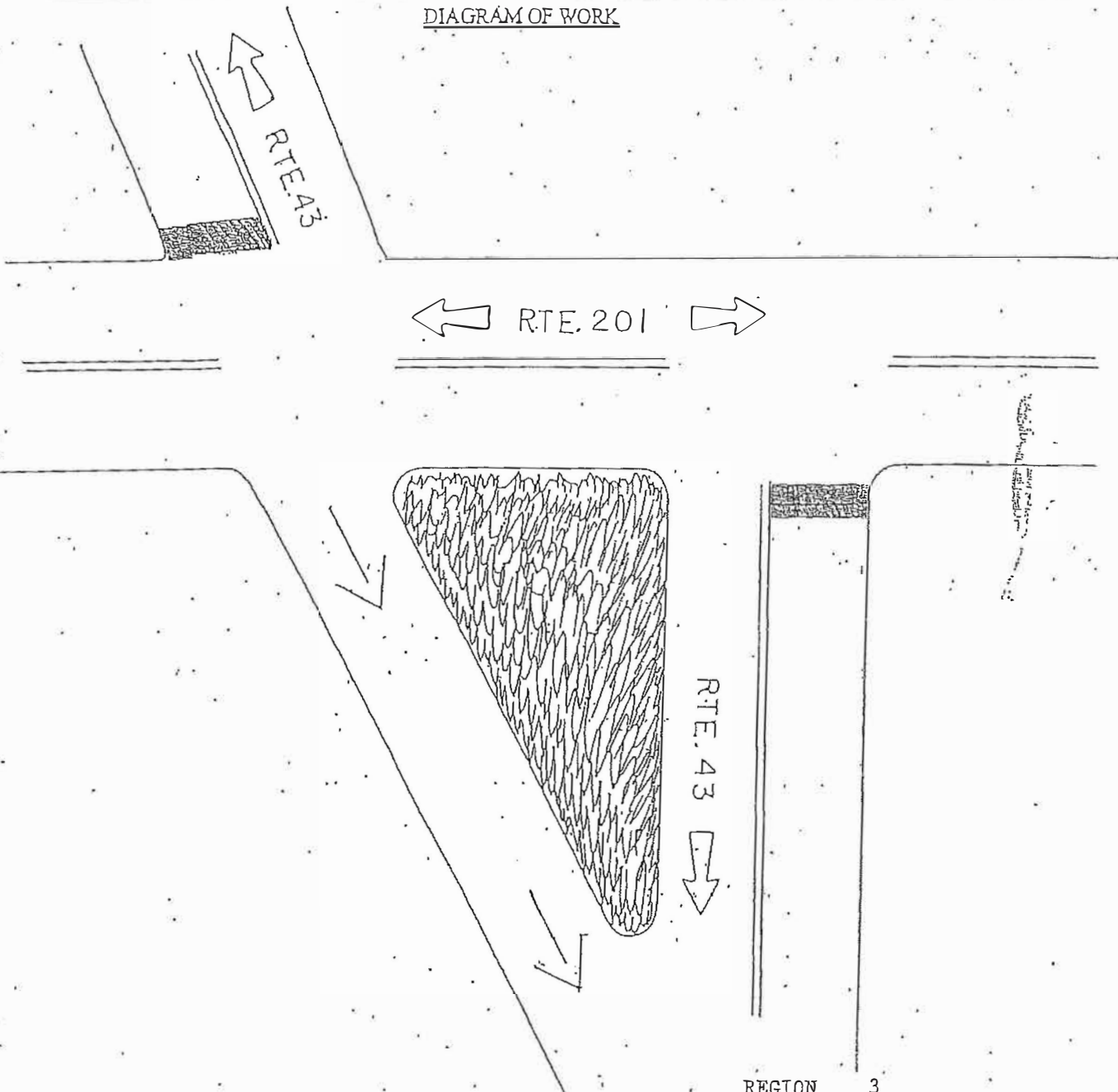

CREW LEADER _____ YES NO

PROJECT DONE BEFORE _____

DATE _____

REGION 3

TOWN MADISON

ROUTE OR 43 & 201

ROAD NO _____

PAVEMENT MARKINGS

Project No. _____

DESCRIPTION OF WORK DONE

Mayfield TWP

Asset: 1037632

Total Sq. Feet: 60

Route 151 and Route 16

Stop Bar: 60

Map: 31

DIAGRAM OF WORK

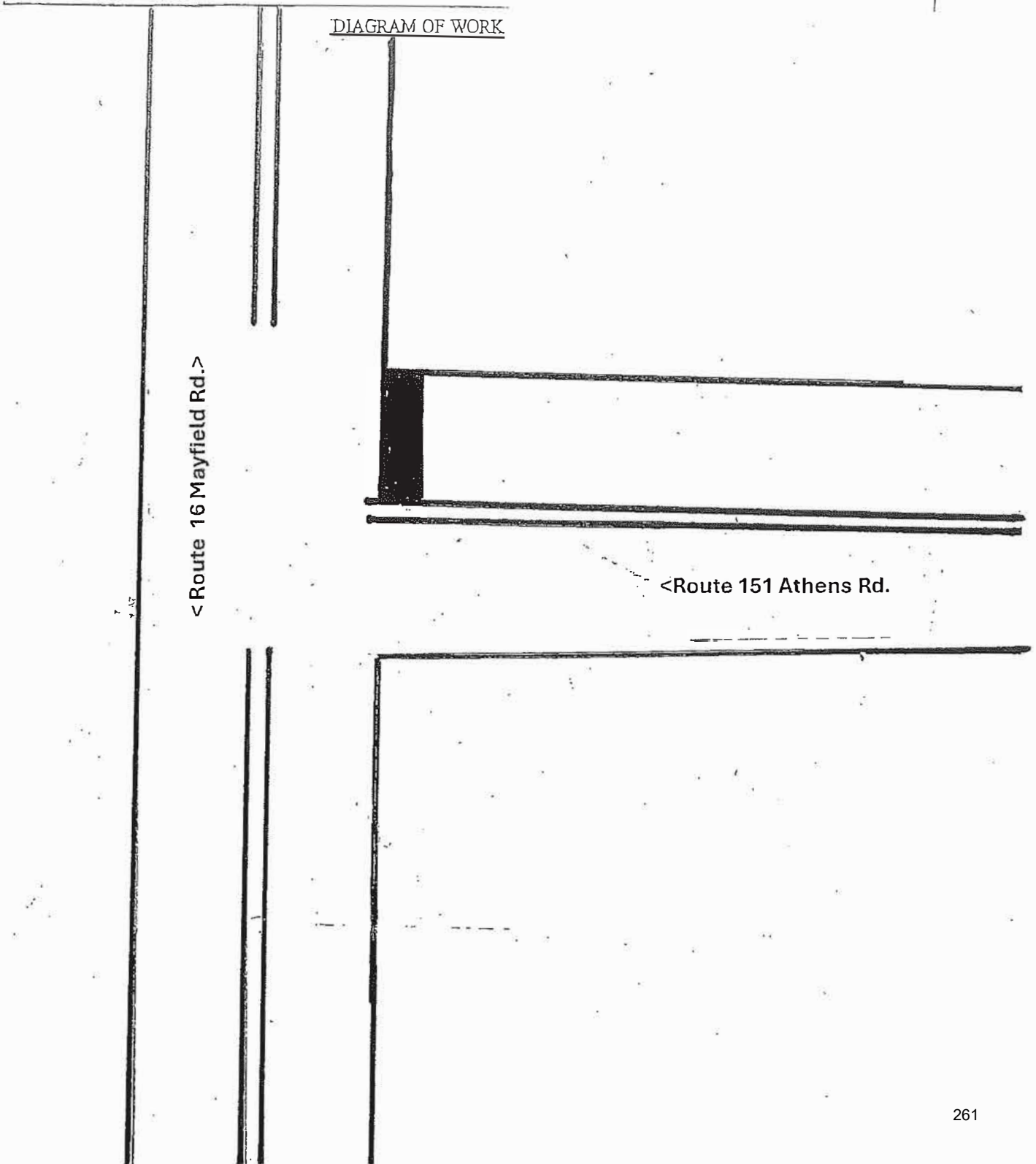

PAVEMENT MARKINGS

Project No. _____

DESCRIPTION OF WORK DONE

Mercer

Asset: 1038814

Total Sq. Feet: 60

Route 137 and Route 2

Stop Bar: 60

Map: 20

DIAGRAM OF WORK

<Route 2 Mercer Rd.

<Route 137 Valley Rd.>

PAVEMENT MARKINGS

905056

Project No. _____

DESCRIPTION OF WORK DONE

STRAIGHT ARROW _____	LANE LINE _____
TURN ARROW <u>96</u>	STOP _____
STOP BAR _____	ONLY _____
CURBING-YELLOW _____	STOP AHEAD _____
WHITE _____	CROSSWALKS _____
HASH MARKS _____	TOTAL SQ. FT. <u>96</u>
MISC. _____	

BOISE
CASCADE

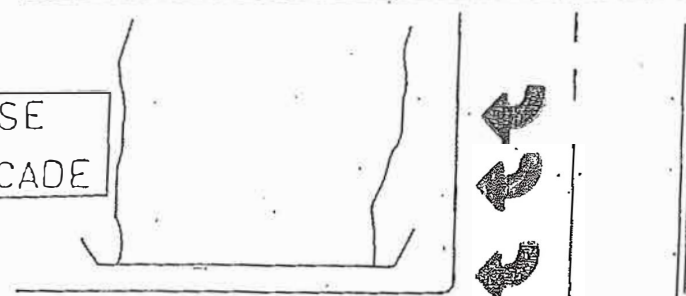

← TO RTE. 108

BRIDGE
DONE
BY
TOWN

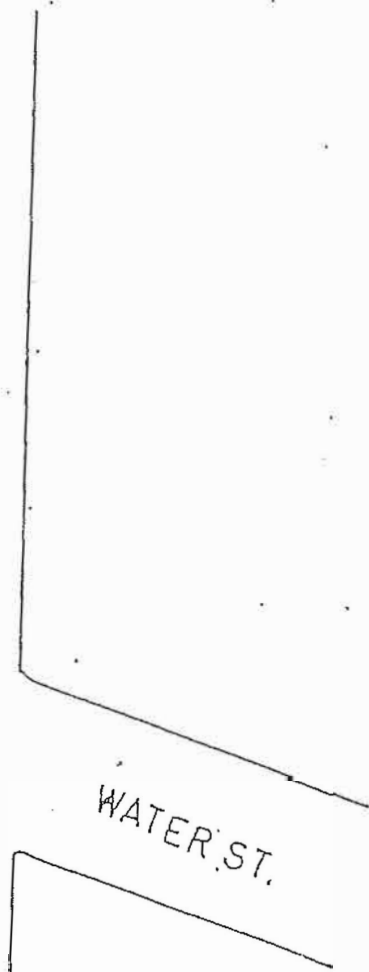
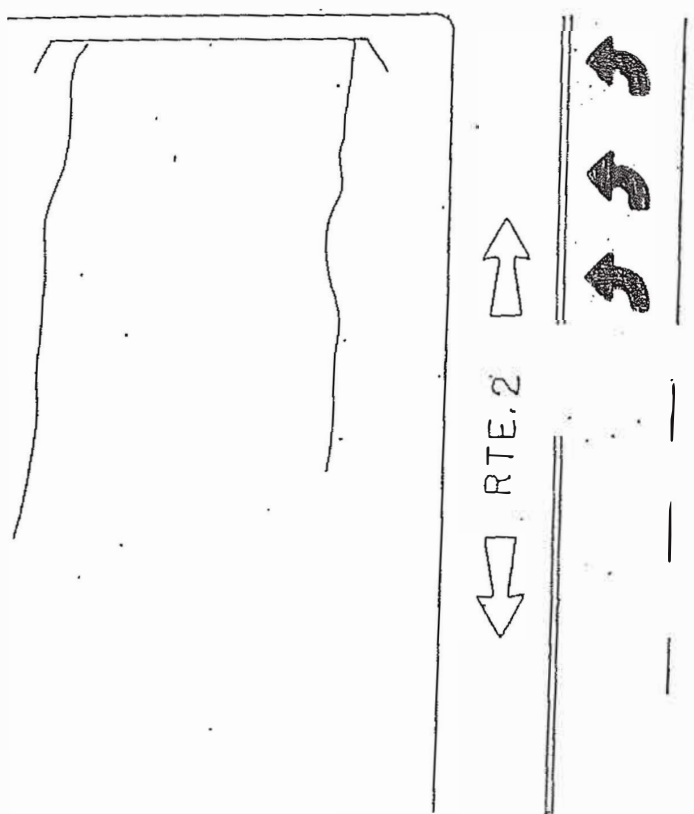

CREW LEADER _____ YES NO
 PROJECT DONE BEFORE _____
 DATE _____
 ACTUAL JOB TIME _____

REGION 3
 TOWN MEXICO
 ROUTE OR 2
 ROAD NO. _____

PAVEMENT MARKINGS

Project No. _____

DESCRIPTION OF WORK DONE

<u>Mexico</u>	<u>Asset: 905063</u>
Total Sq. Feet: 236	
Stop Bar: 140	Route 2 and North Main St.
Turn Arrows: 96	

DIAGRAM OF WORK

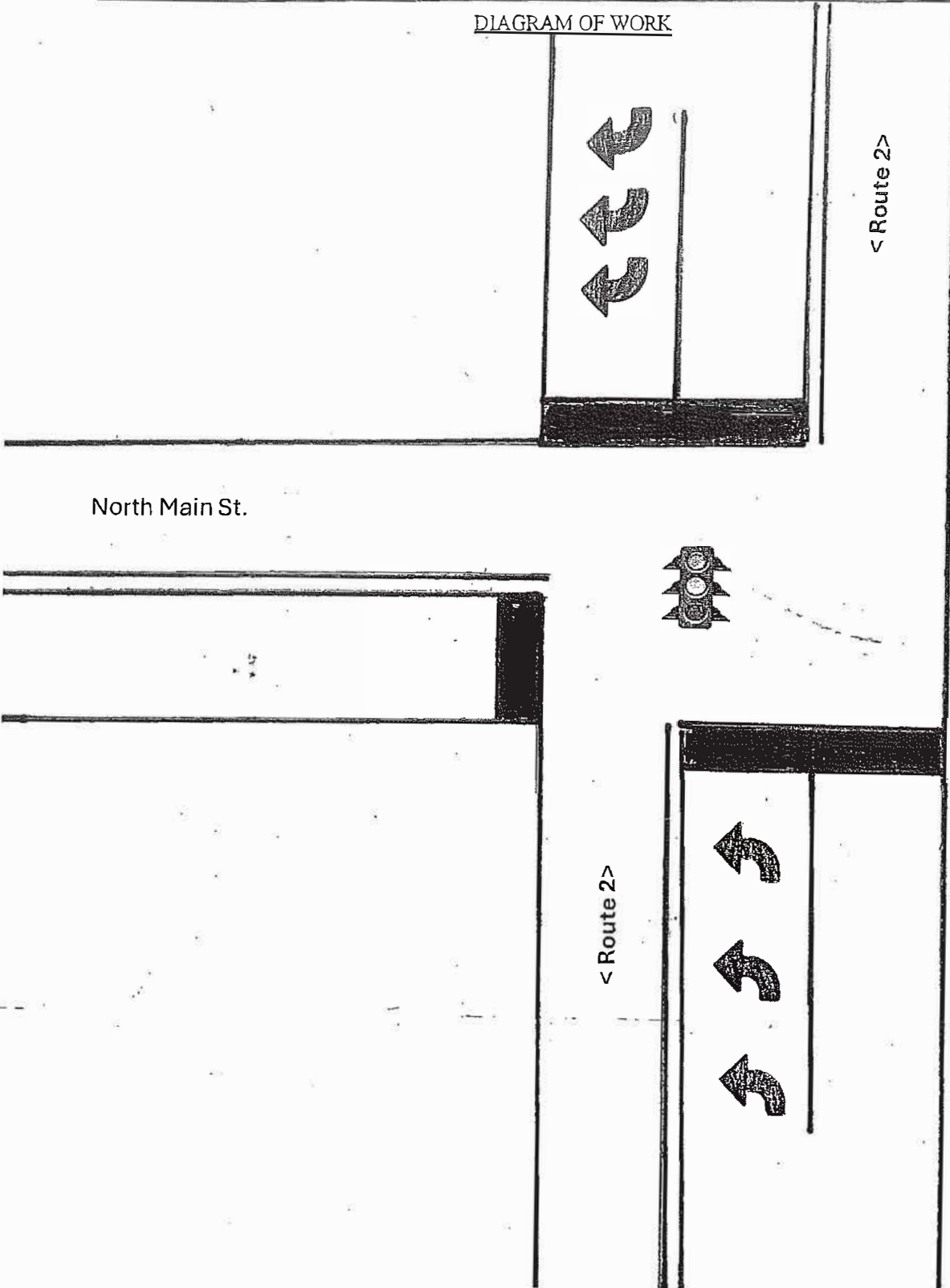

PAVEMENT MARKINGS

905070

Project No. _____

DESCRIPTION OF WORK DONE

STRAIGHT ARROW _____	LANE LINE _____
TURN ARROW _____	STOP _____ 22 _____
STOP BAR _____ 72 _____	ONLY _____
CURBING-YELLOW _____	STOP AHEAD _____ 39 _____
WHITE _____	CROSSWALKS _____
HASH MARKS _____	TOTAL SQ. FT. _____ 133 _____
MISC. _____	

DIAGRAM OF WORK

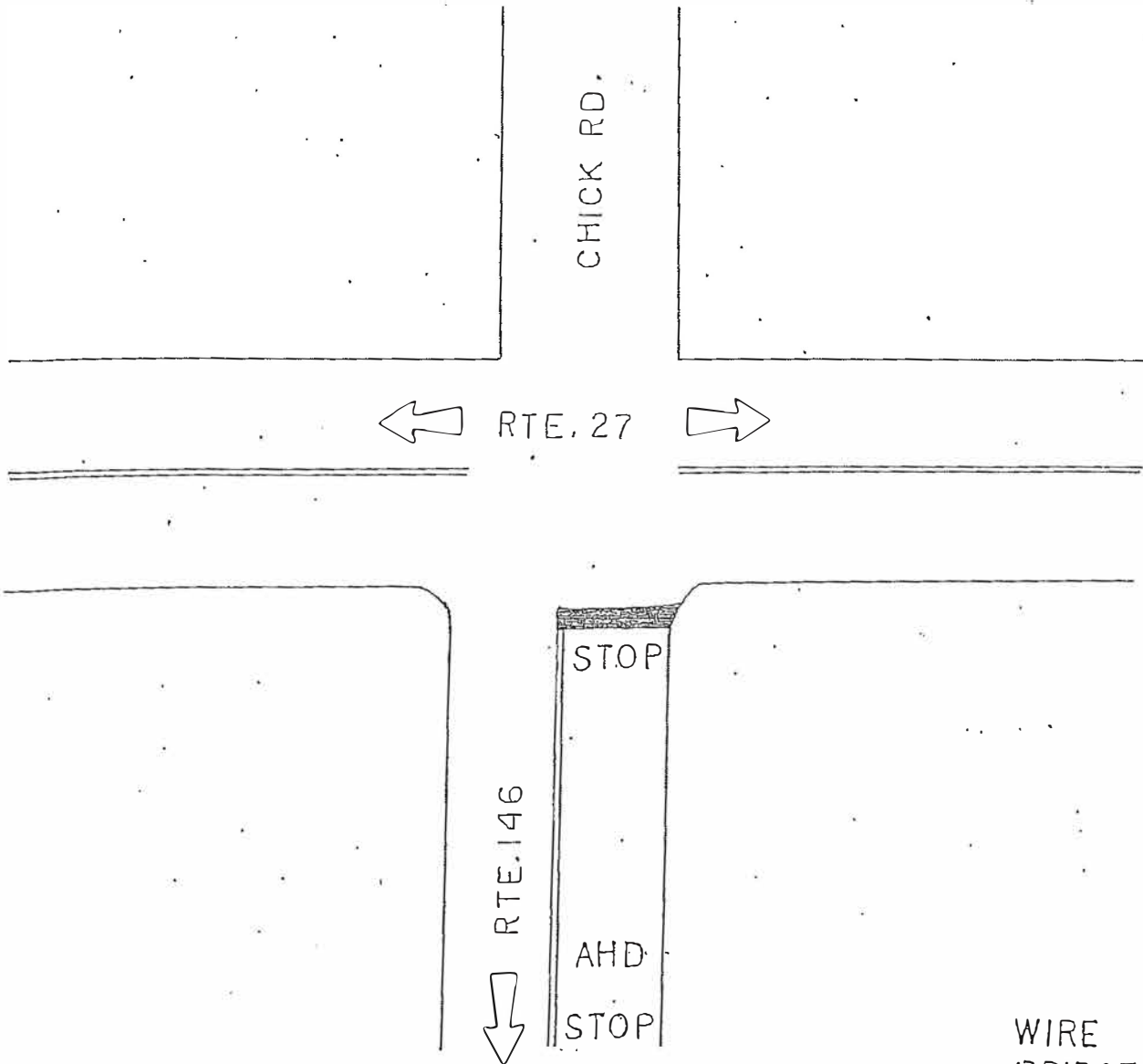

CREW LEADER _____

PROJECT DONE BEFORE _____ YES NO

DATE _____

ACTUAL JOB TIME _____

REGION 3

TOWN NEW PORTLAND

ROUTE OR 27&146

ROAD NO. _____

905083

PAVEMENT MARKINGS

Project No. _____

DESCRIPTION OF WORK DONE

STRAIGHT ARROW _____	LANE LINE _____
TURN ARROW _____	STOP _____ 22 _____
STOP BAR _____ 84 _____	ONLY _____
CURBING-YELLOW _____	STOP AHEAD _____ 37 _____
WHITE _____	CROSSWALKS _____
HASH MARKS _____	TOTAL SQ. FT. _____ 143 _____
MISC. _____	

DIAGRAM OF WORK

STORE

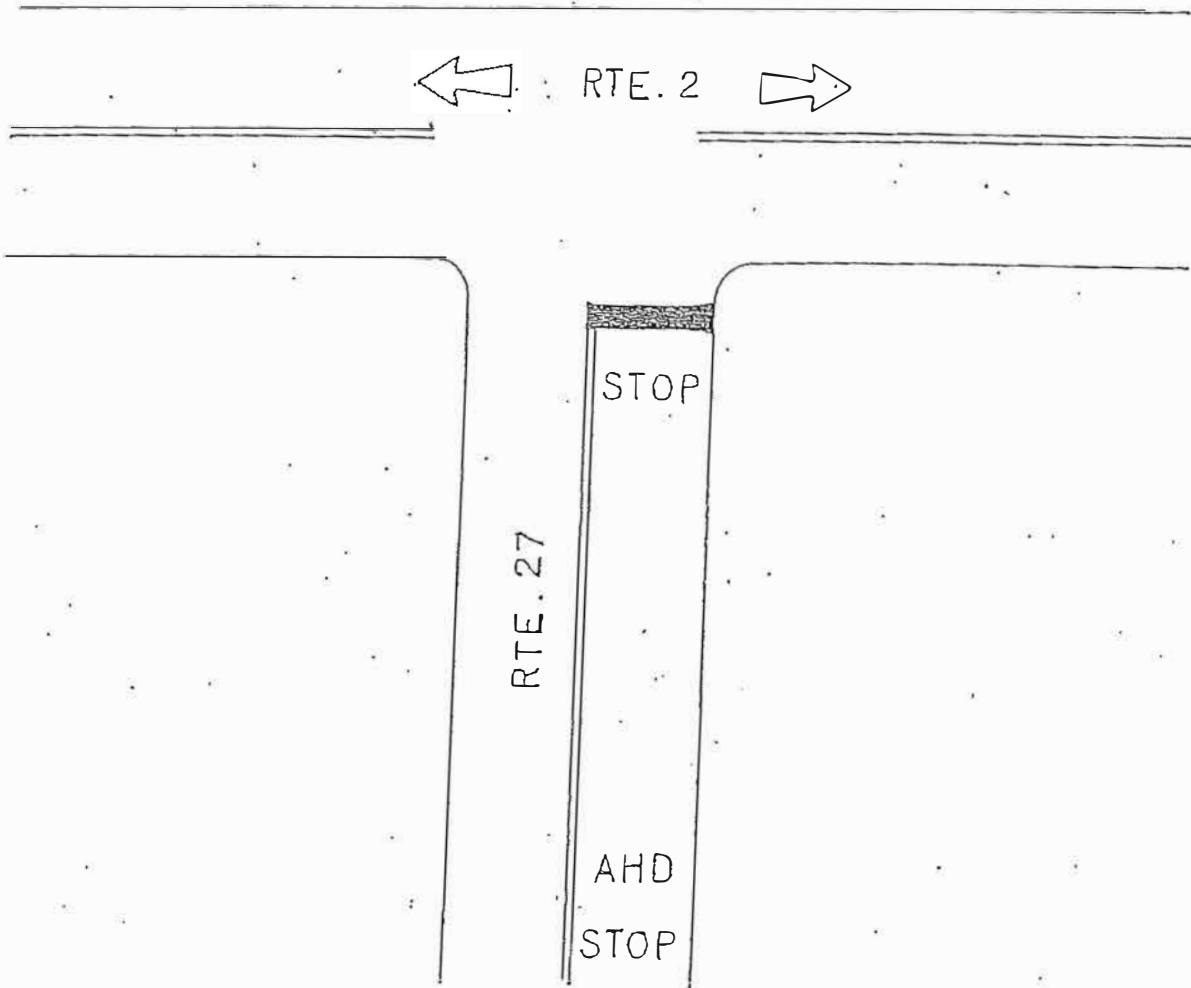

CREW LEADER _____
YES NO

REGION. 3

905085

PAVEMENT MARKINGS

Project No. _____

DESCRIPTION OF WORK DONE

STRAIGHT ARROW _____	LANE LINE _____
TURN ARROW _____	STOP _____ 22 _____
STOP BAR _____ 36 _____	ONLY _____
CURBING-YELLOW _____	STOP AHEAD _____ 37 _____
WHITE _____ 5 _____	CROSSWALKS _____
HASH MARKS _____	TOTAL SQ. FT. _____ 100 _____
MISC. _____	

DIAGRAM OF WORK

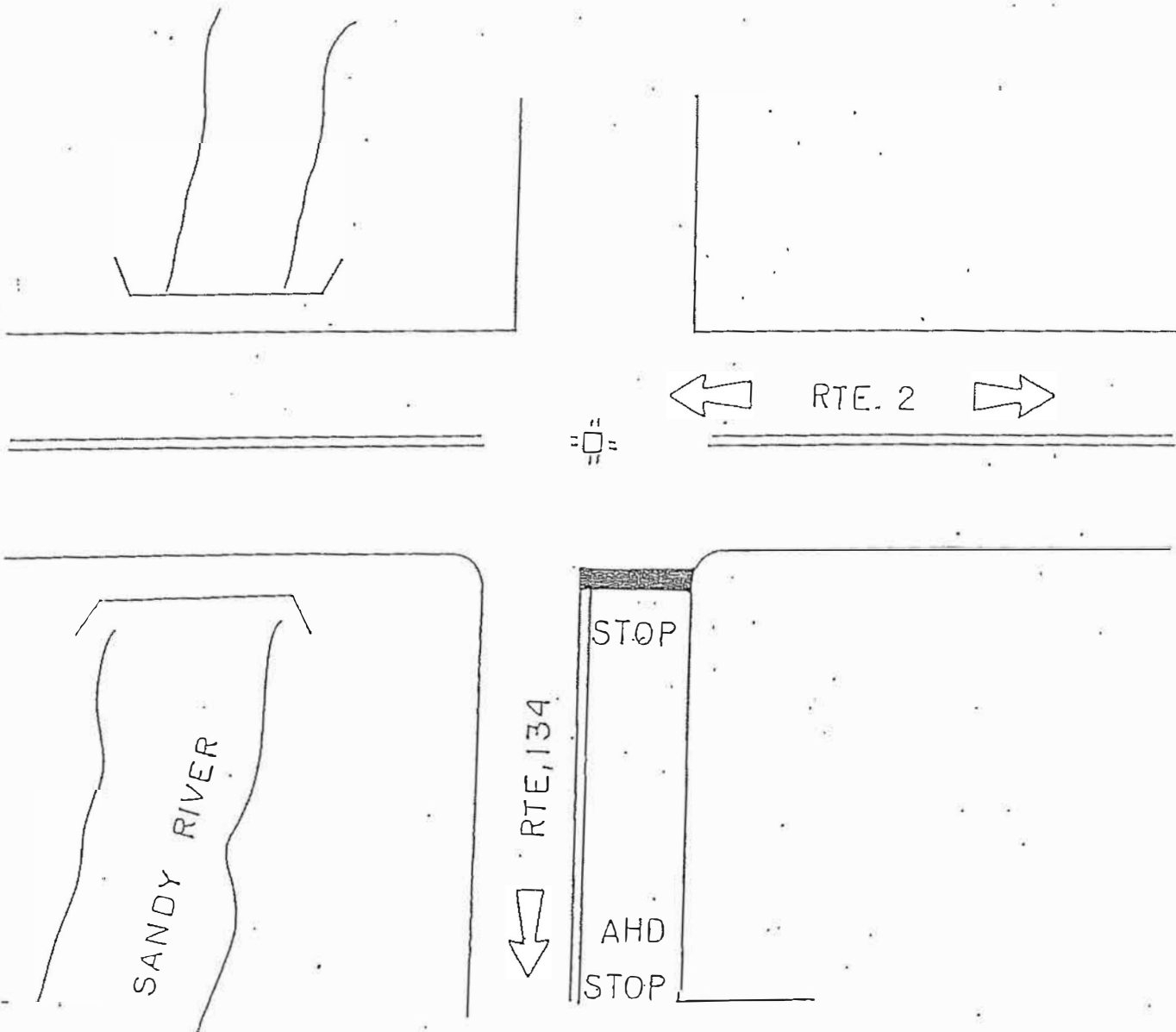

CREW LEADER _____

YES NO

PROJECT DONE BEFORE _____

REGION 3

TOWN NEW SHARON

2 x 134

PAVEMENT MARKINGS

Project No. _____

DESCRIPTION OF WORK DONE

New Sharon		Asset: 1038810
Total Sq. Feet:	60	Route 134 and Route 2
Stop Bar:	60	Map: 20

DIAGRAM OF WORK

<Route 134 Cape Cod Hill Rd.>

<Route 2 Mercer Rd.>

PAVEMENT MARKINGS

Project No. _____

DESCRIPTION OF WORK DONE

New Sharon	Asset: 1038808
Total Sq. Feet: 90	Route 134 and Route 41
Stop Bar: 90	Map: 20

DIAGRAM OF WORK

< Route 134 Cape Cod Hill Rd.>

<Route 41 Vienna Rd.>

PAVEMENT MARKINGS

Project No. _____

DESCRIPTION OF WORK DONE

<u>New Vineyard</u>	Asset: 1038955
Total Sq. Feet: 30	Route 234 and Route 27
Stop Bar: 30	Map: 20

DIAGRAM OF WORK

<Route 234 Lake St.>

<Route 27 New Vineyard Rd.>

PAVEMENT MARKINGS

Project No. _____

DESCRIPTION OF WORK DONE

New Vineyard

Asset: 1038958

Total Sq. Feet: 60

Route 234 and Route 27 and Anson Valley RD

Stop Bar: 60

Map: 20

DIAGRAM OF WORK

<Route 27 New Vineyard Rd.

<Route 234 Anson Valley RD.>

PAVEMENT MARKINGS

905081

Project No. _____

DESCRIPTION OF WORK DONE

STRAIGHT ARROW _____	LANE LINE _____
TURN ARROW _____	STOP _____ 22
STOP BAR _____ 44	ONLY _____
CURBING-YELLOW _____	STOP AHEAD _____ 3.7
WHITE _____	CROSSWALKS _____
HASH MARKS _____	TOTAL SQ. FT. _____ 103
MISC. _____	

DIAGRAM OF WORK

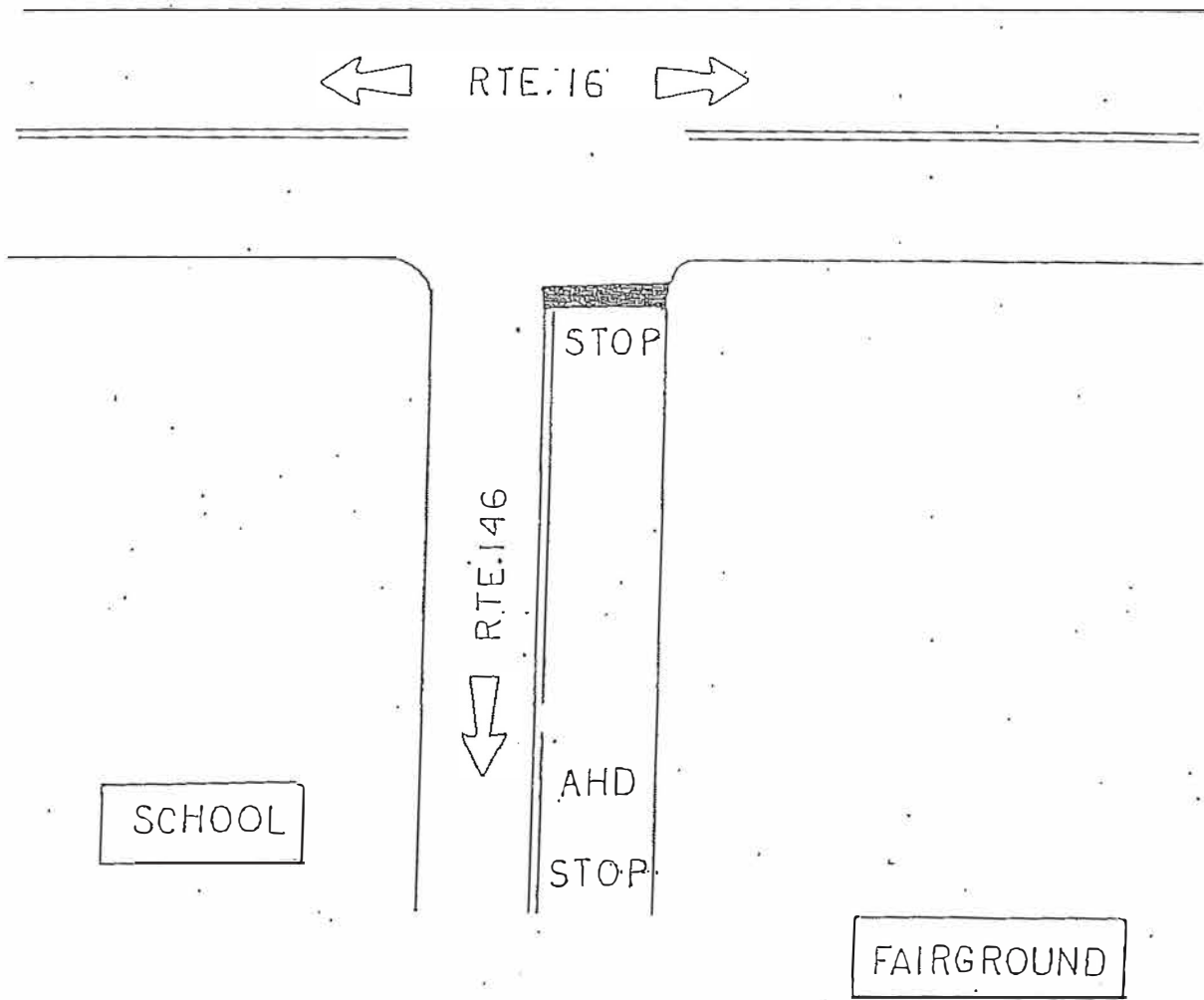

CREW LEADER _____
 YES NO
 PROJECT DONE BEFORE _____
 DATE _____
 ACTUAL JOB TIME _____

REGION 3

TOWN NO. NEW PORTLAND
 ROUTE OR 146 & 16
 ROAD NO.

PAVEMENT MARKINGS

905089

Project No. _____

DESCRIPTION OF WORK DONE

STRAIGHT ARROW _____	LANE LINE _____
TURN ARROW <u>64</u>	STOP _____
STOP BAR <u>195</u>	ONLY _____
CURBING-YELLOW _____	STOP AHEAD _____
WHITE _____	CROSSWALKS _____
HASH MARKS _____	TOTAL SQ. FT. <u>285</u>
MISC. <u>WRONG WAY ARROW</u> 25	

DIAGRAM OF WORK

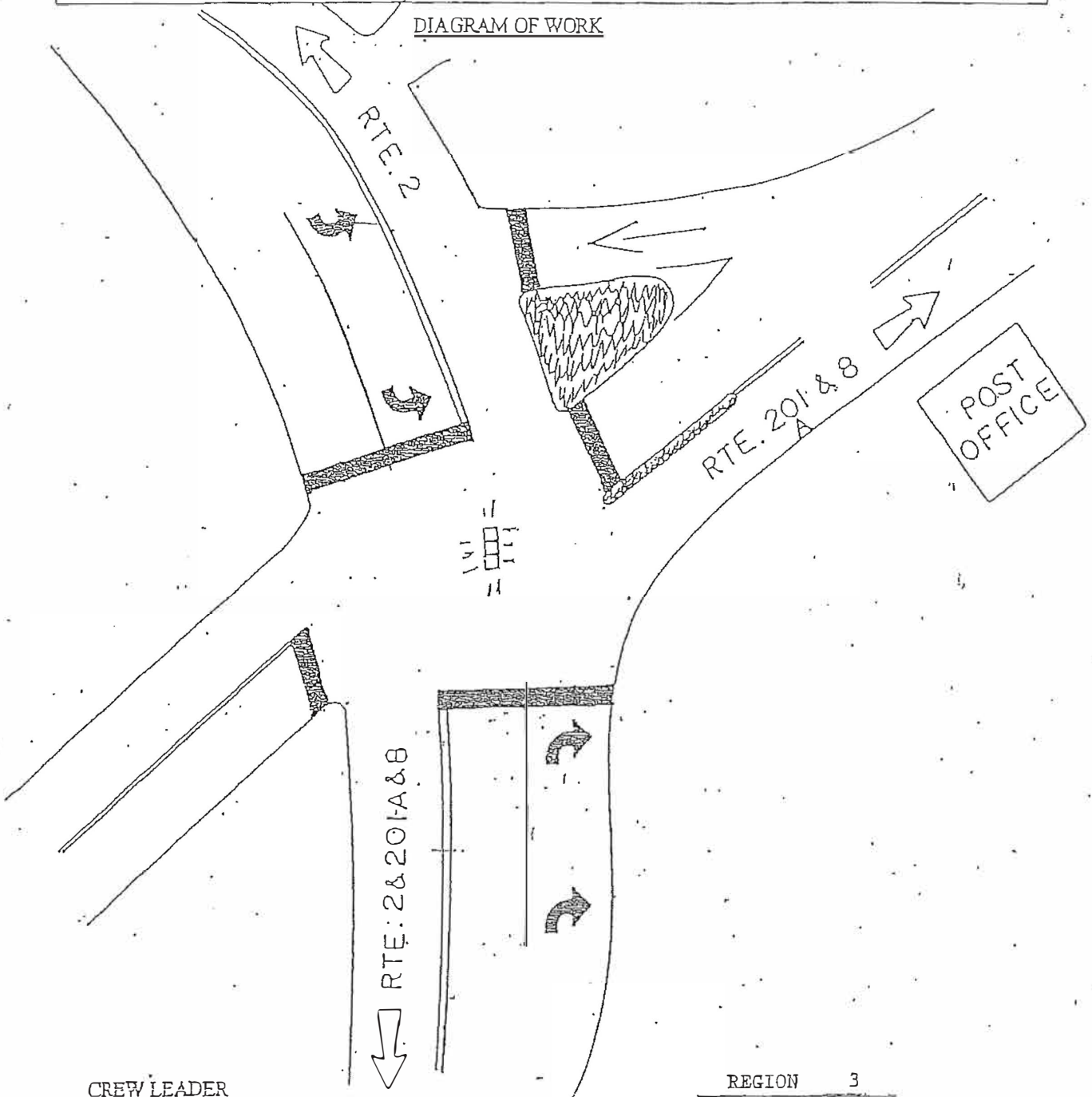

CREW LEADER _____ YES NO

REGION 3

PROJECT DONE BEFORE _____

DATE _____

ACTUAL JOB TIME _____

TOWN NORRIGDEWOCK
ROUTE OR 2 & 201-A & 8
ROAD NO.

905095

PAVEMENT MARKINGS

Project No. _____

DESCRIPTION OF WORK DONE

STRAIGHT ARROW _____	LANE LINE _____
TURN ARROW _____	STOP _____ 22 _____
STOP BAR _____ 34 _____	ONLY _____
CURBING-YELLOW _____	STOP AHEAD _____ 37 _____
WHITE _____	CROSSWALKS _____
HASH MARKS _____	TOTAL SQ. FT. _____ 93 _____
MISC. _____	

DIAGRAM OF WORK

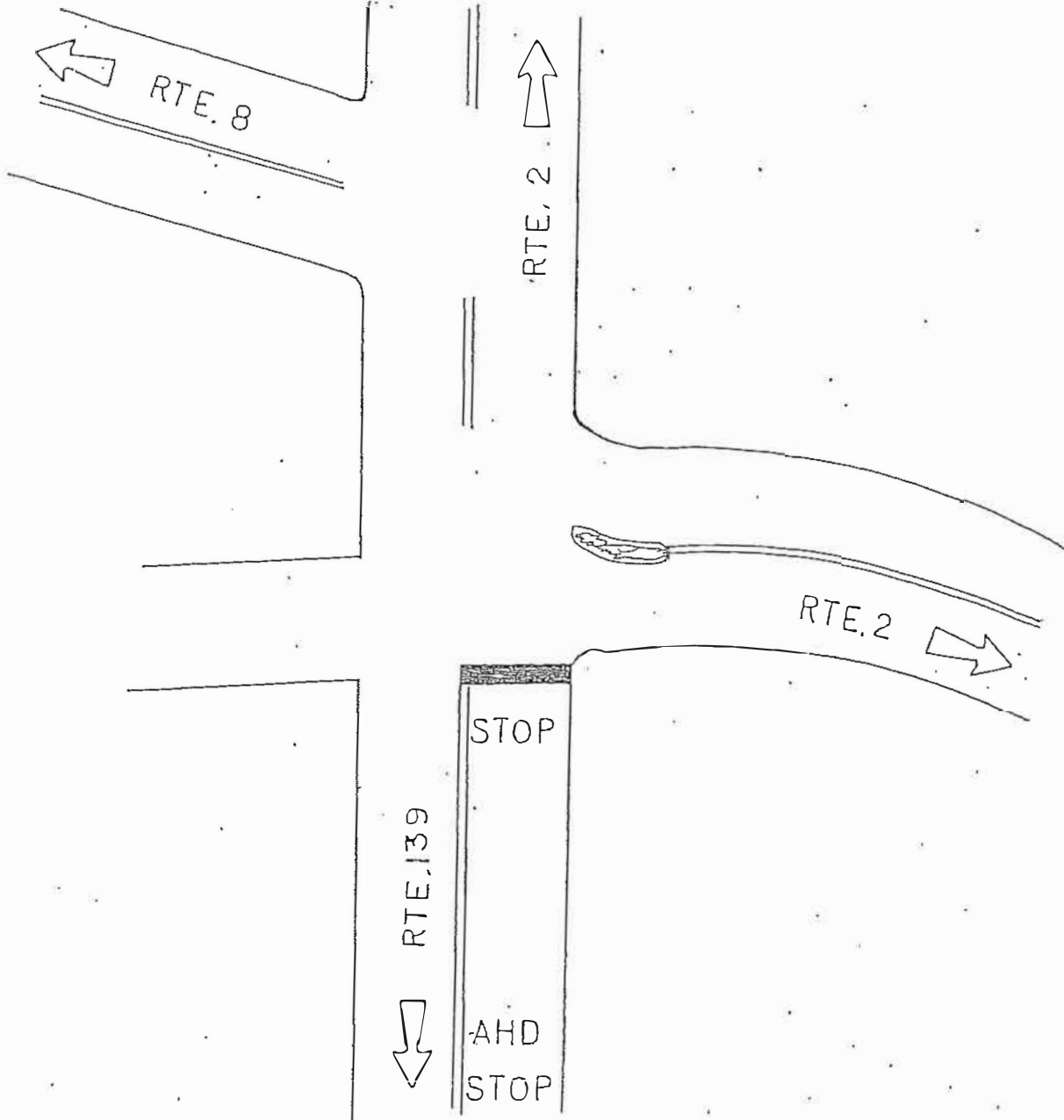

CREW LEADER _____
YES NO

REGION 3

TOWN NORRIGDEWOCK

905097

PAVEMENT MARKINGS

Project No. _____

DESCRIPTION OF WORK DONE

STRAIGHT ARROW _____	LANE LINE _____
TURN ARROW _____	STOP _____ 22
STOP BAR _____ 80	ONLY _____
CURBING-YELLOW _____	STOP AHEAD _____ 37
WHITE _____ 50	CROSSWALKS _____
HASH MARKS _____	TOTAL SQ. FT. _____ 189
MISC. _____	

DIAGRAM OF WORK

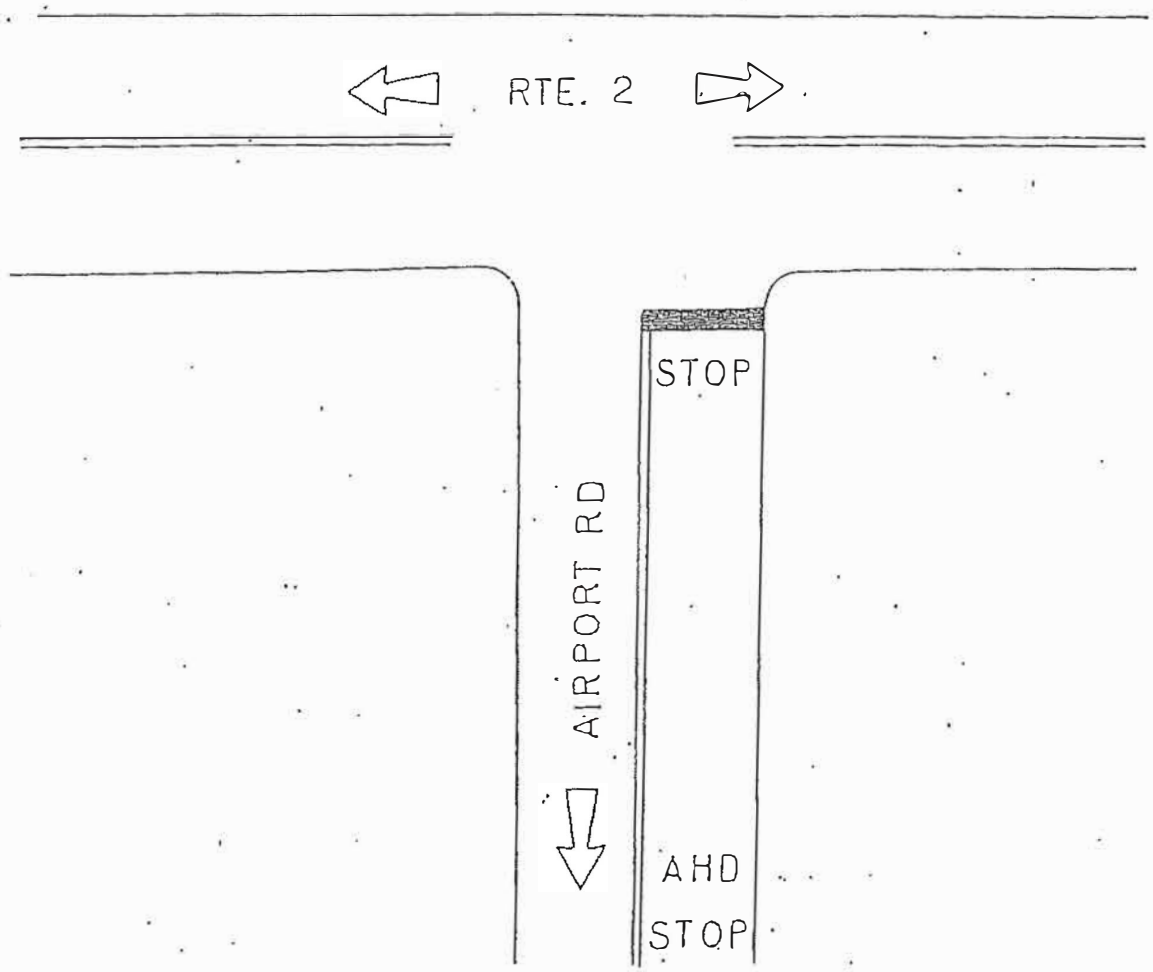

CREW LEADER _____ YES NO

REGION 3

TOWN NORRISDEWOCK

PAVEMENT MARKINGS

905099

Project No. _____

DESCRIPTION OF WORK DONE

Peru

Asset: 905099

Total Sq Feet: 188

Stop Bar: 88

Yellow Curb: 100

DIAGRAM OF WORK

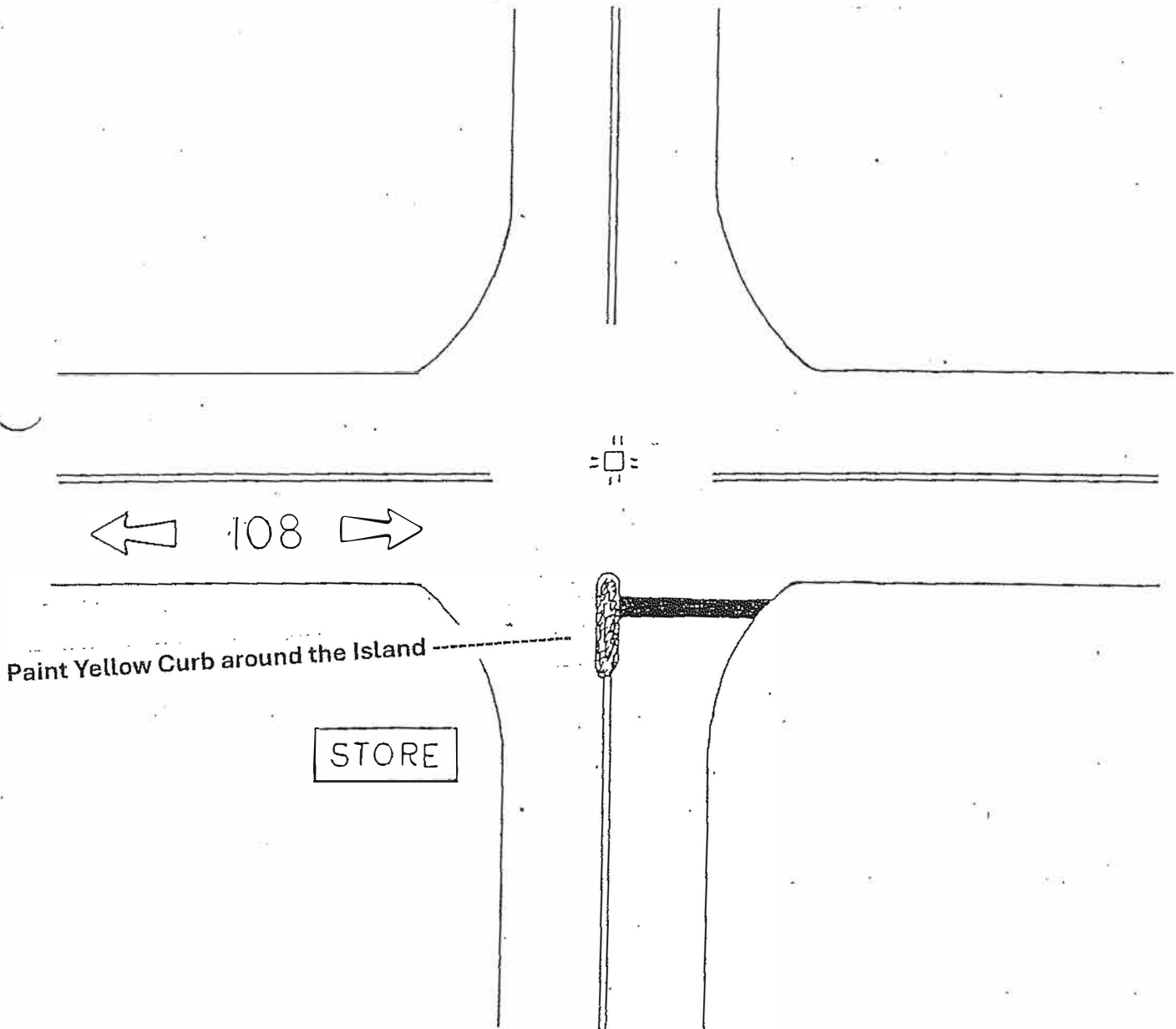

CREW LEADER _____
 YES NO
 PROJECT DONE BEFORE _____
 DATE _____
 ACTUAL JOB TIME _____

REGION 3

TOWN PERU
 ROUTE OR 108
 ROAD NO. _____

DESCRIPTION OF WORK DONE

STRAIGHT ARROW _____	LANE LINE _____
TURN ARROW _____ 96 _____	STOP _____
STOP BAR _____	ONLY _____
CURBING-YELLOW _____	STOP AHEAD _____
WHITE _____	CROSSWALKS _____
HASH MARKS _____	TOTAL SQ. FT. _____ 96 _____
MISC. _____	

DIAGRAM OF WORK

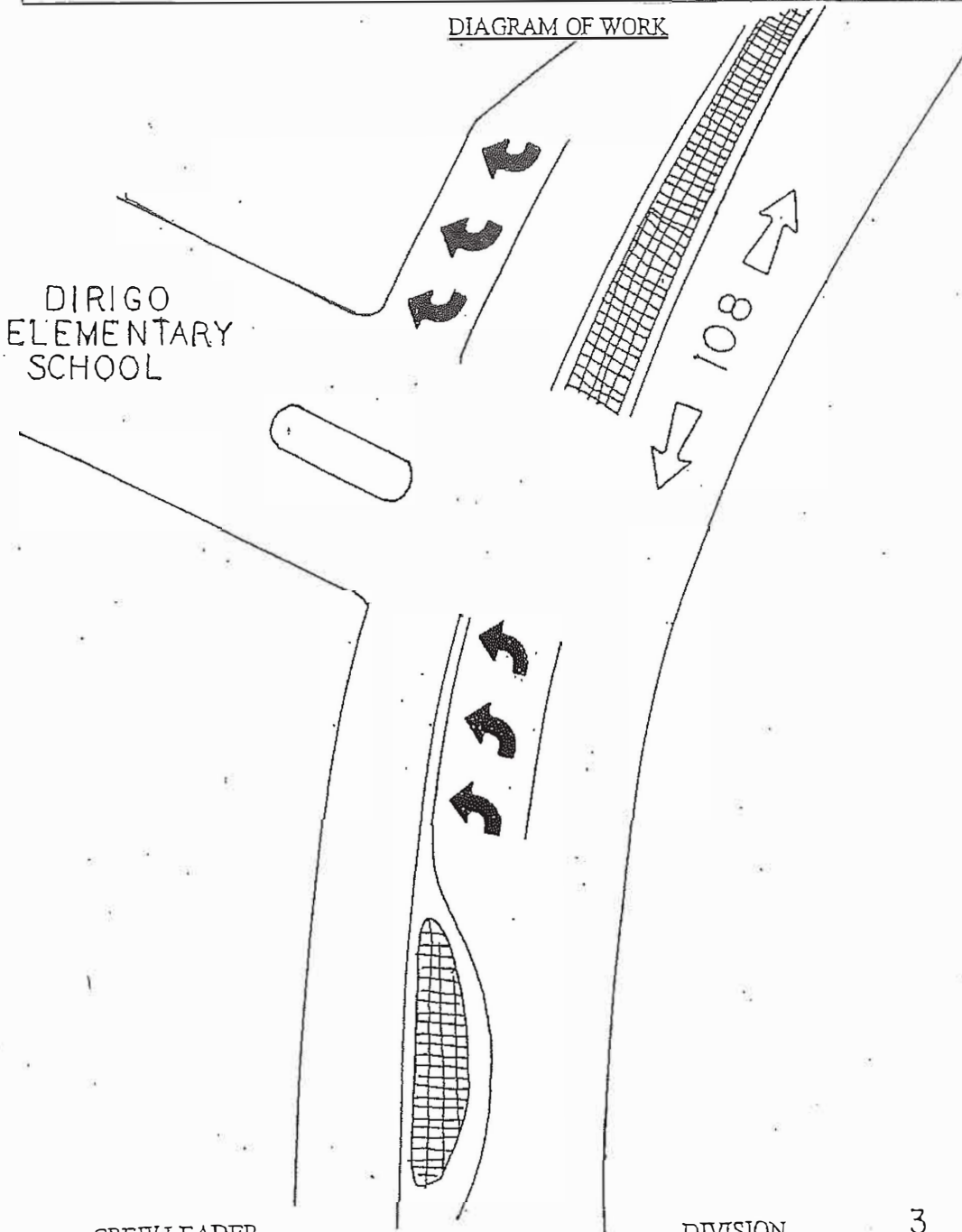

CREW LEADER _____ YES NO

PROJECT DONE BEFORE _____

DATE _____

ACTUAL JOB TIME _____

DIVISION _____ 3 _____

TOWN _____ PERU _____

ROUTE OR _____ 108 _____

ROAD NO. _____

PAVEMENT MARKINGS

990223

Project No. _____

DESCRIPTION OF WORK DONE

STRAIGHT ARROW _____	LANE LINE _____
TURN ARROW _____	STOP _____ 22 _____
STOP BAR _____ 40 _____	ONLY _____
CURBING-YELLOW _____	STOP AHEAD _____ 39 _____
WHITE _____	CROSSWALKS _____
HASH MARKS _____	TOTAL SQ. FT. _____ 101 _____
MISC. _____	

DIAGRAM OF WORK

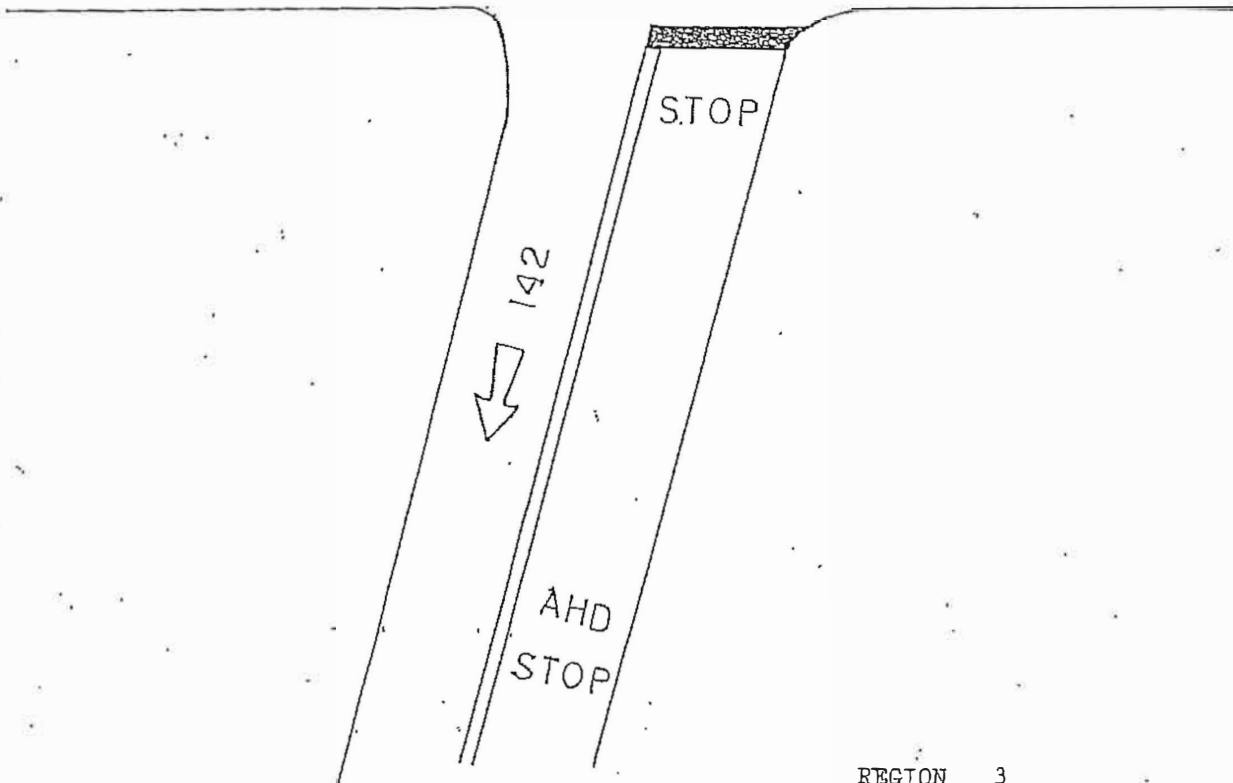
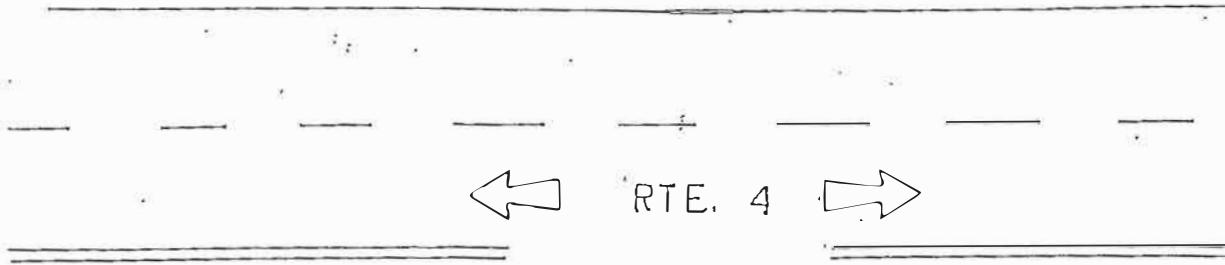

CREW LEADER _____ YES NO
 PROJECT DONE BEFORE _____
 DATE _____
 ACTUAL JOB TIME _____

REGION 3

TOWN PHILLIPS
 ROUTE OR 4 & 142
 ROAD NO. _____

PAVEMENT MARKINGS

Project No. _____

DESCRIPTION OF WORK DONE

Phillips	Asset: 1003745
Total Sq. Feet: 125	Route 142 and Route 4 and Route 149
Stop Bar: 125	Paint Stop Bars on Both sides of Road
Map: 19	

DIAGRAM OF WORK

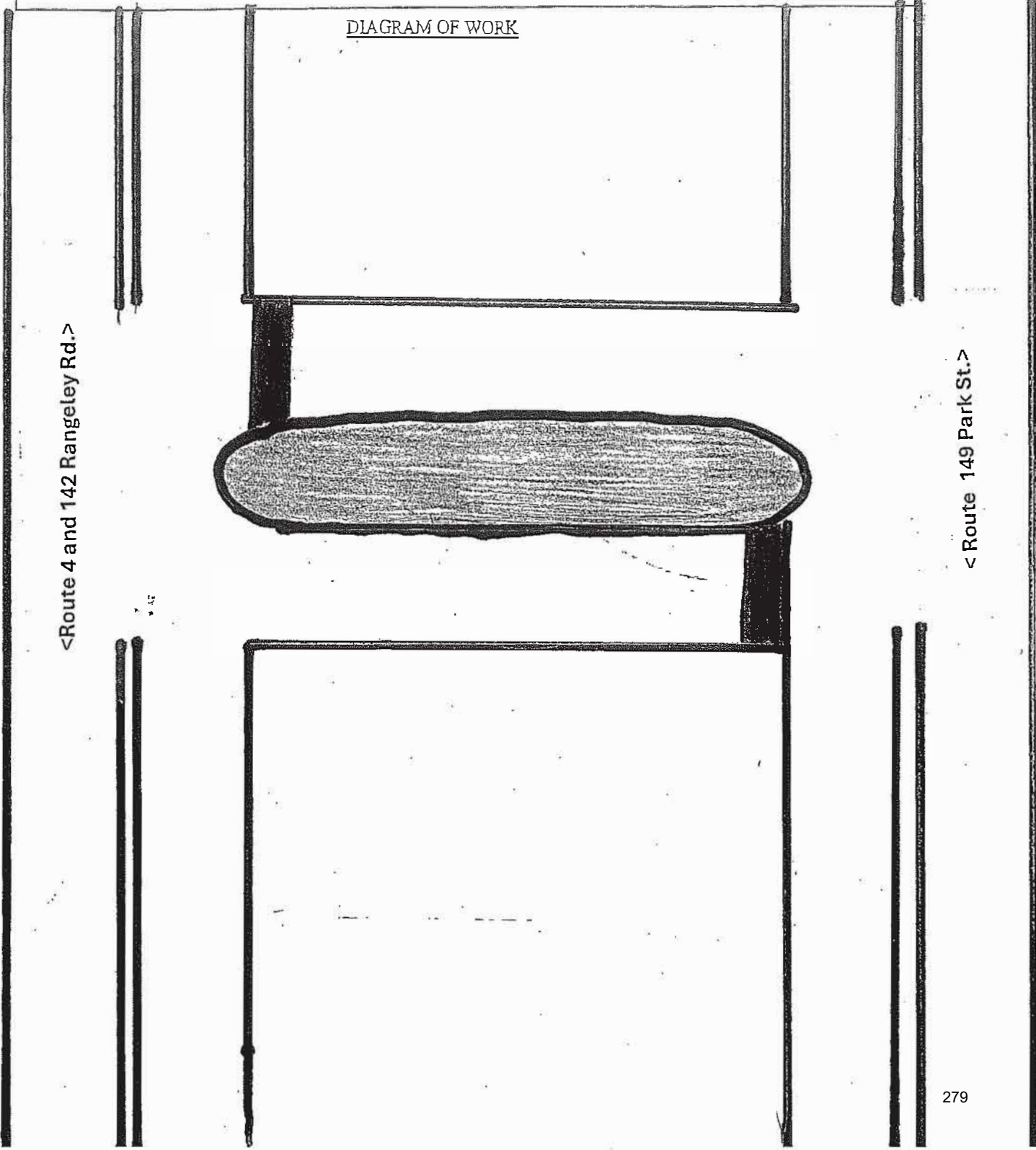

<Route 4 and 142 Rangeley Rd.>

<Route 149 Park St.>

PAVEMENT MARKINGS

905119

Project No. _____

DESCRIPTION OF WORK DONE

STRAIGHT ARROW _____	LANE LINE _____
TURN ARROW <u>32</u>	STOP _____
STOP BAR _____	ONLY _____
CURBING-YELLOW _____	STOP AHEAD _____
WHITE _____	CROSSWALKS _____
HASH MARKS _____	TOTAL SQ. FT. <u>32</u>
MISC. _____	

DIAGRAM OF WORK

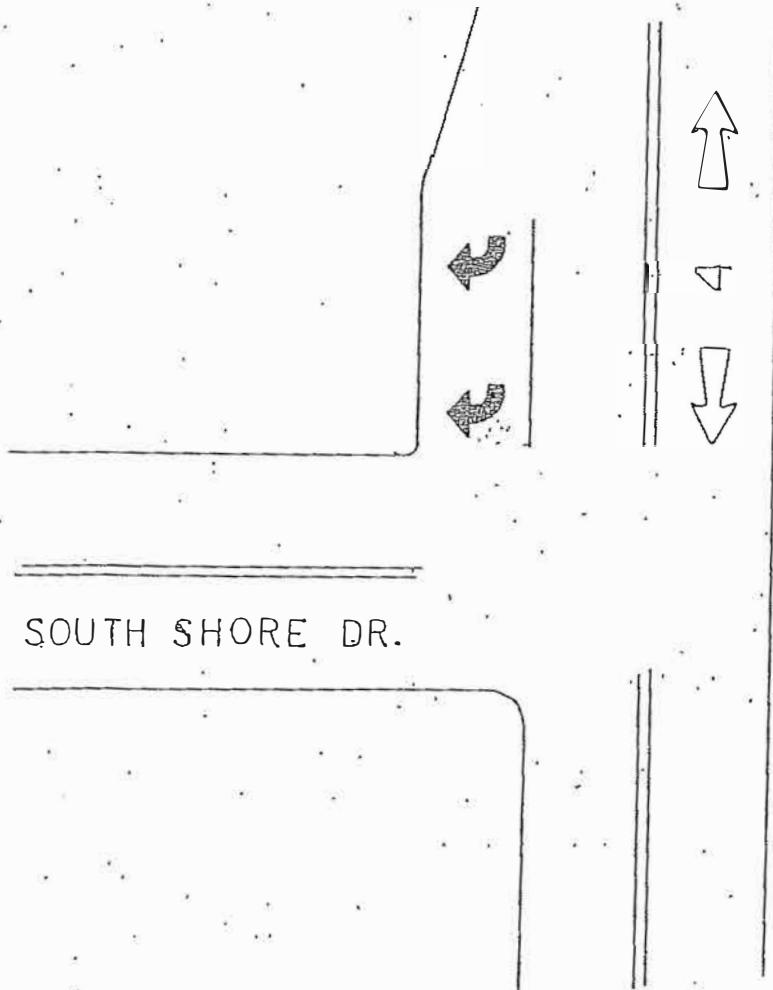

CREW LEADER _____
YES NO
PROJECT DONE BEFORE _____
DATE _____

DIVISION _____
TOWN RANGELEY
ROUTE OR 4 & S. SHORE DR.
ROAD NO. _____

PAVEMENT MARKINGS

905122

Project No. _____

DESCRIPTION OF WORK DONE

STRAIGHT ARROW _____	LANE LINE _____
TURN ARROW _____	STOP _____ 22 _____
STOP BAR _____ 30 _____	ONLY _____
CURBING-YELLOW _____	STOP AHEAD _____ 39 _____
WHITE _____	CROSSWALKS _____
HASH MARKS _____	TOTAL SQ. FT. _____ 91 _____
MISC. _____	

DIAGRAM OF WORK

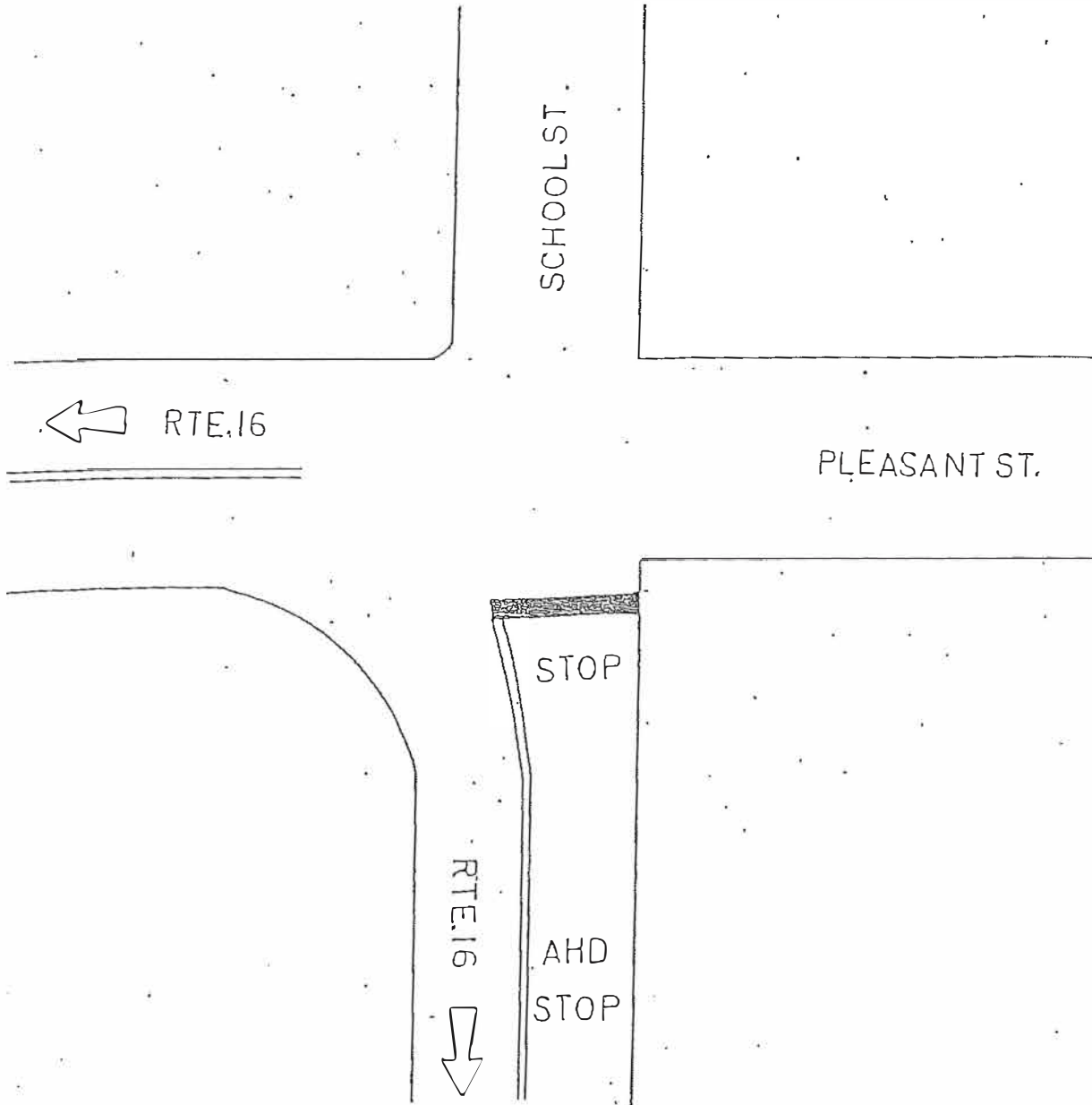

CREW LEADER _____ YES · NO

PROJECT DONE BEFORE _____
DATE _____
ACTUAL JOB TIME _____

REGION 3

TOWN RANGLEY
ROUTE OR 16 & PLEASANT ST.
ROAD NO.

PAVEMENT MARKINGS

905128

Project No. _____

DESCRIPTION OF WORK DONE

STRAIGHT ARROW _____	LANE LINE _____
TURN ARROW <u>32</u>	STOP _____
STOP BAR <u>56</u>	ONLY _____
CURBING-YELLOW _____	STOP AHEAD _____
WHITE _____	CROSSWALKS _____
HASH MARKS _____	TOTAL SQ. FT. <u>88</u>
MISC. _____	

DIAGRAM OF WORK

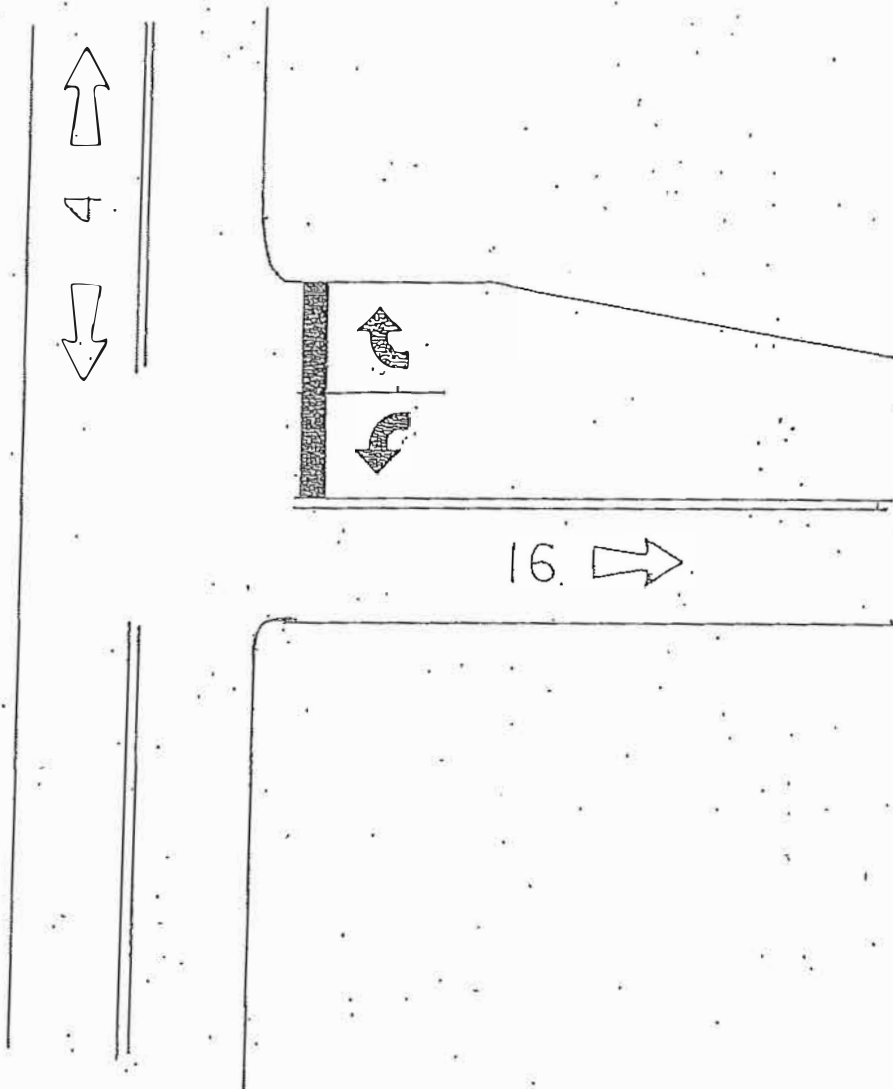

CREW LEADER _____ YES NO

DIVISION _____

PROJECT DONE BEFORE _____

TOWN RANGELEY

DATE _____

ROUTE OR 4 & 16

ACTUAL JOB TIME _____

ROAD NO. _____

PAVEMENT MARKINGS

Project No. _____

DESCRIPTION OF WORK DONE

Ripley		Asset: 1002880
Total Sq. Feet: 48		Route 152 and Route 154
Stop Bar: 48		Map: 31

DIAGRAM OF WORK

<Route 152 Page Hill Rd.>

<Route 154 Stream Rd.>

PAVEMENT MARKINGS

Project No. _____

DESCRIPTION OF WORK DONE

Ripley

Asset: 1038825

Total Sq. Feet: 50

Route 2 and Route 152 and Route 154

Stop Bar: 50

Map: 31

DIAGRAM OF WORK

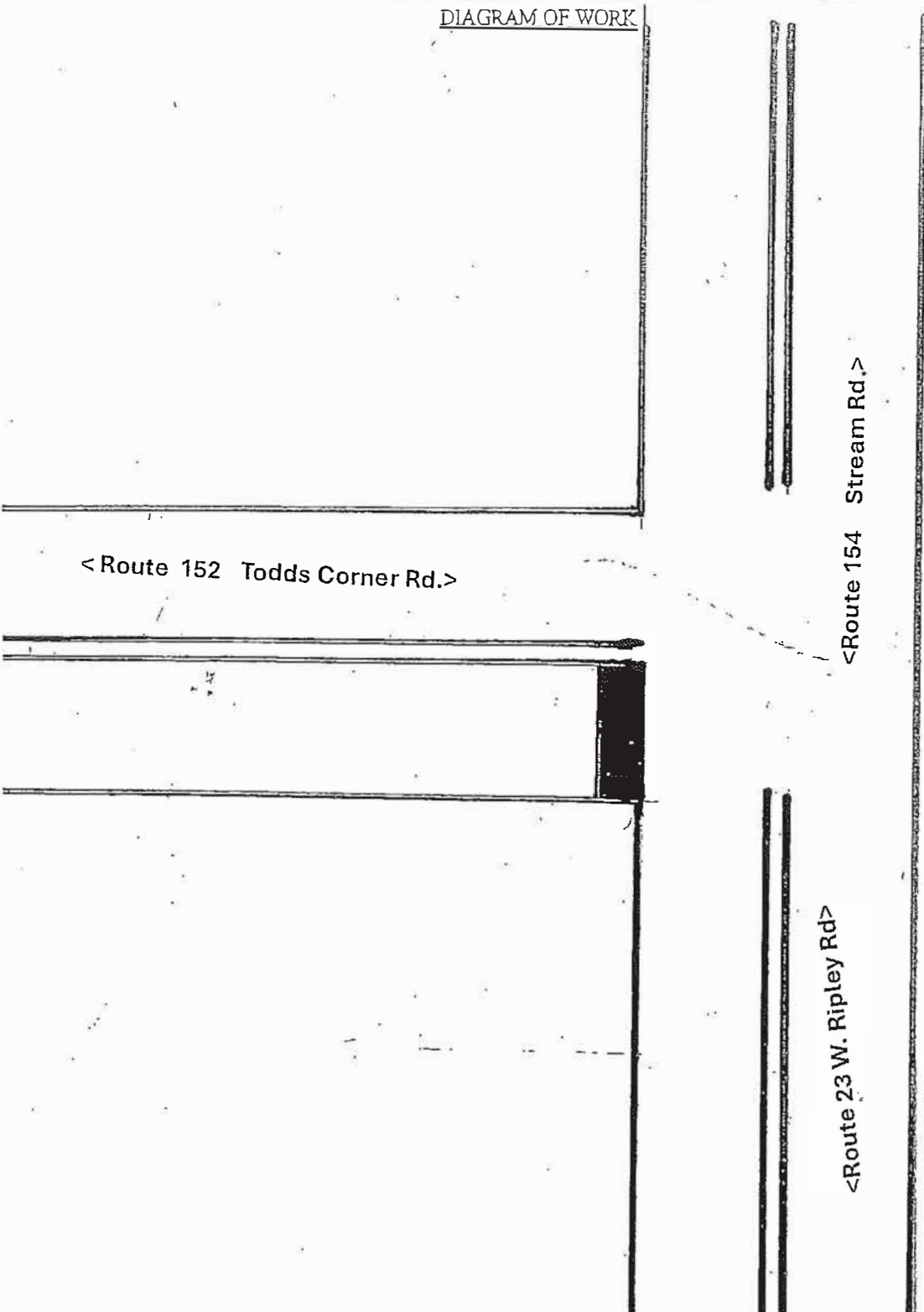

905133

PAVEMENT MARKINGS

Project No. _____

DESCRIPTION OF WORK DONE

STRAIGHT ARROW _____
 TURN ARROW _____ 80 _____
 STOP BAR _____
 CURBING-YELLOW _____
 WHITE _____
 HASH MARKS _____
 MISC. _____

LANE LINE _____
 STOP _____
 ONLY _____
 STOP AHEAD _____
 CROSSWALKS _____
 TOTAL SQ. FT. 80 _____

DIAGRAM OF WORK

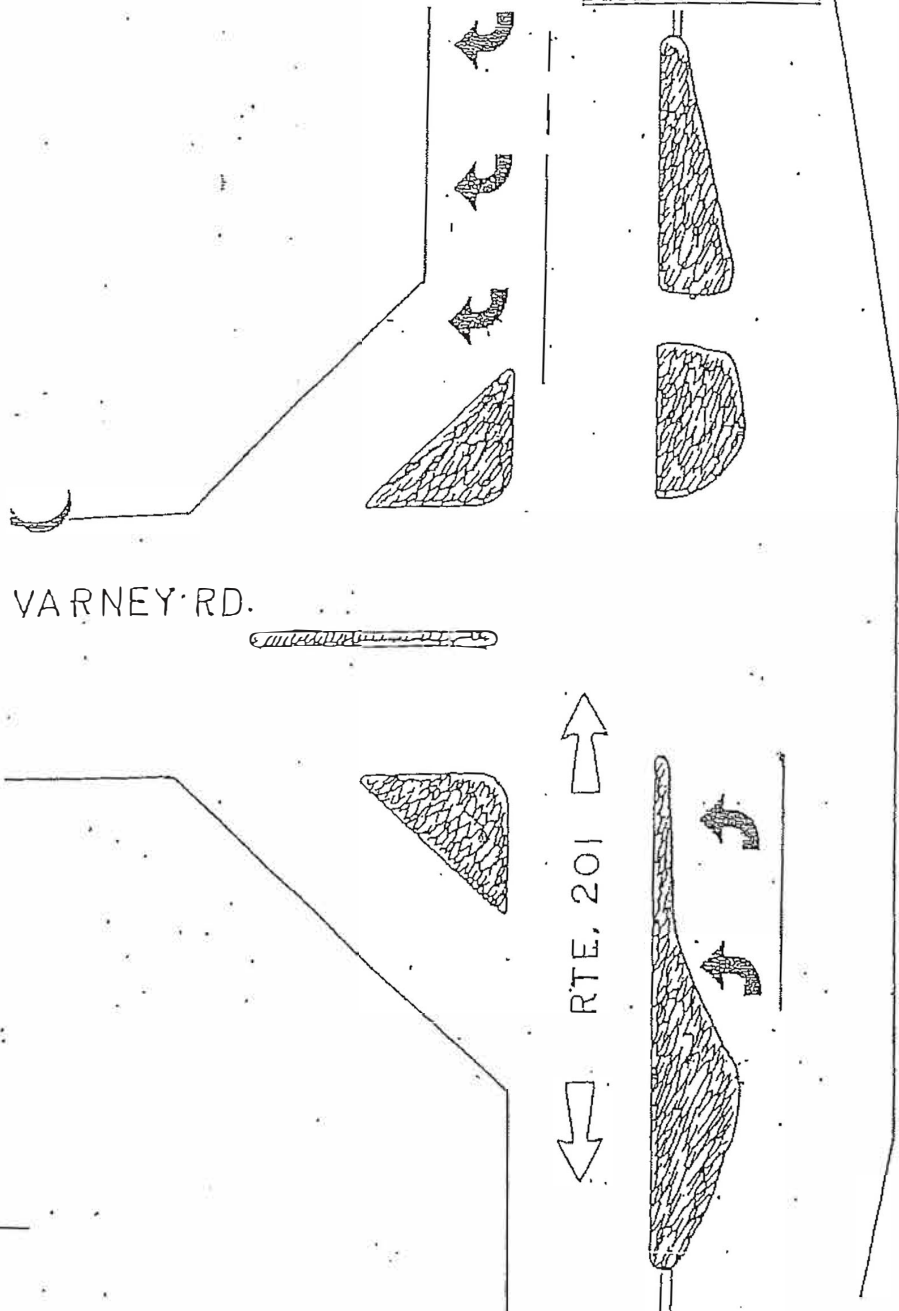

CREW LEADER _____ YES NO

REGION. 3

905135

PAVEMENT MARKINGS

Project No. _____

DESCRIPTION OF WORK DONE

STRAIGHT ARROW _____	LANE LINE _____
TURN ARROW _____ <u>64</u> _____	STOP _____
STOP BAR _____	ONLY _____
CURBING-YELLOW _____	STOP AHEAD _____
WHITE _____	CROSSWALKS _____
HASH MARKS _____	TOTAL SQ. FT. <u>64</u> _____
MISC. _____	

DIAGRAM OF WORK

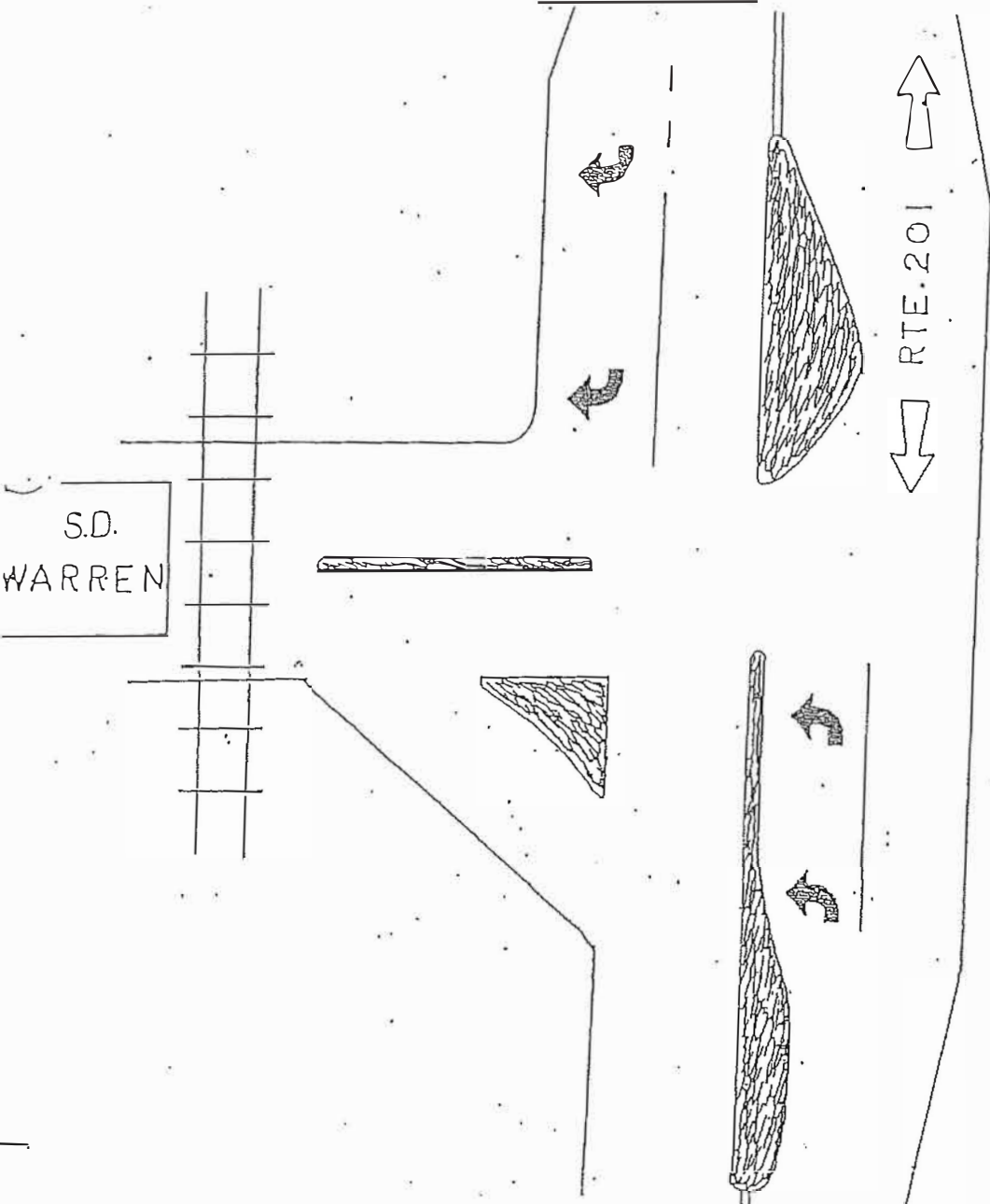

CREW LEADER _____
YES NO

REGION 3

TOWN SKOWHEGAN

PAVEMENT MARKINGS

Project No. _____

DESCRIPTION OF WORK DONE

Smithfield	Asset: 1038820
Total Sq. Feet: 50	Route 137 and Route 8
Stop Bar: 50	Map: 20

DIAGRAM OF WORK

<Route 137 Lake View Dr.>

<Route 8 Village Rd.>

PAVEMENT MARKINGS

Project No. _____

DESCRIPTION OF WORK DONE

Starks

Asset: 1038792

Total Sq. Feet: 40

Route 134 and Route 43

Stop Bar: 40

Map: 20

DIAGRAM OF WORK

<Route 43 Industry Rd.>

<Route 134 New Sharon Rd.>

DESCRIPTION OF WORK DONE

St. Albans		Asset: 1080851
Total Sq. Feet:	30	Route 43 and Route 23
Stop Bar:	30	Map: 21/31

DIAGRAM OF WORK

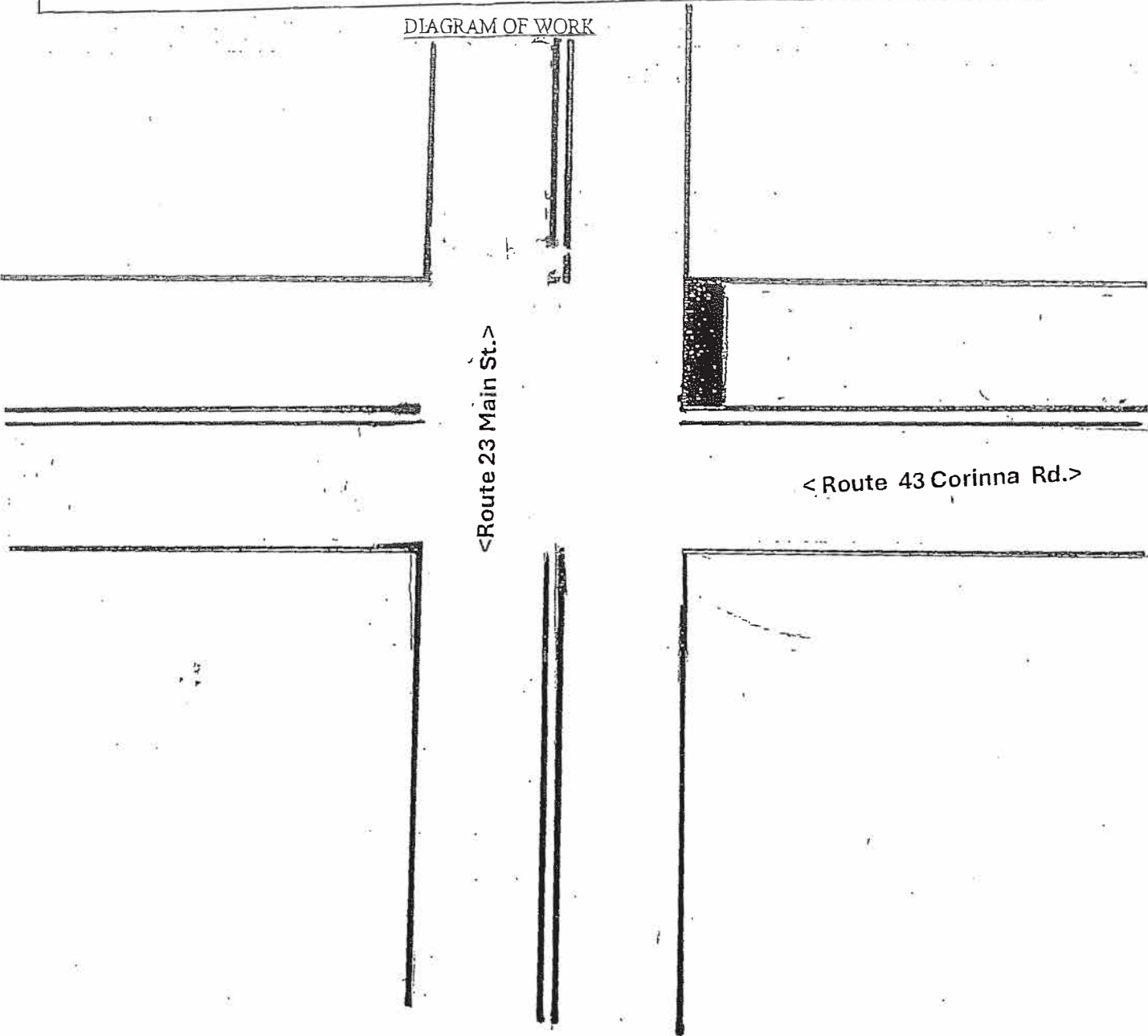

CREW LEADER _____
 YES NO
 PROJECT DONE BEFORE _____
 DATE _____
 ACTUAL JOB TIME _____

DIVISION _____
 TOWN _____
 ROUTE OR _____
 ROAD NO. _____

PAVEMENT MARKINGS

Project No. _____

905137

DESCRIPTION OF WORK DONE

STRAIGHT ARROW _____	LANE LINE _____
TURN ARROW <u>64</u>	STOP _____
STOP BAR <u>30</u>	ONLY _____
CURBING-YELLOW _____	STOP AHEAD _____
WHITE _____	CROSSWALKS _____
HASH MARKS <u>1160</u>	TOTAL SQ. FT. <u>275</u>
MISC. YIELD BAR <u>21</u>	

DIAGRAM OF WORK

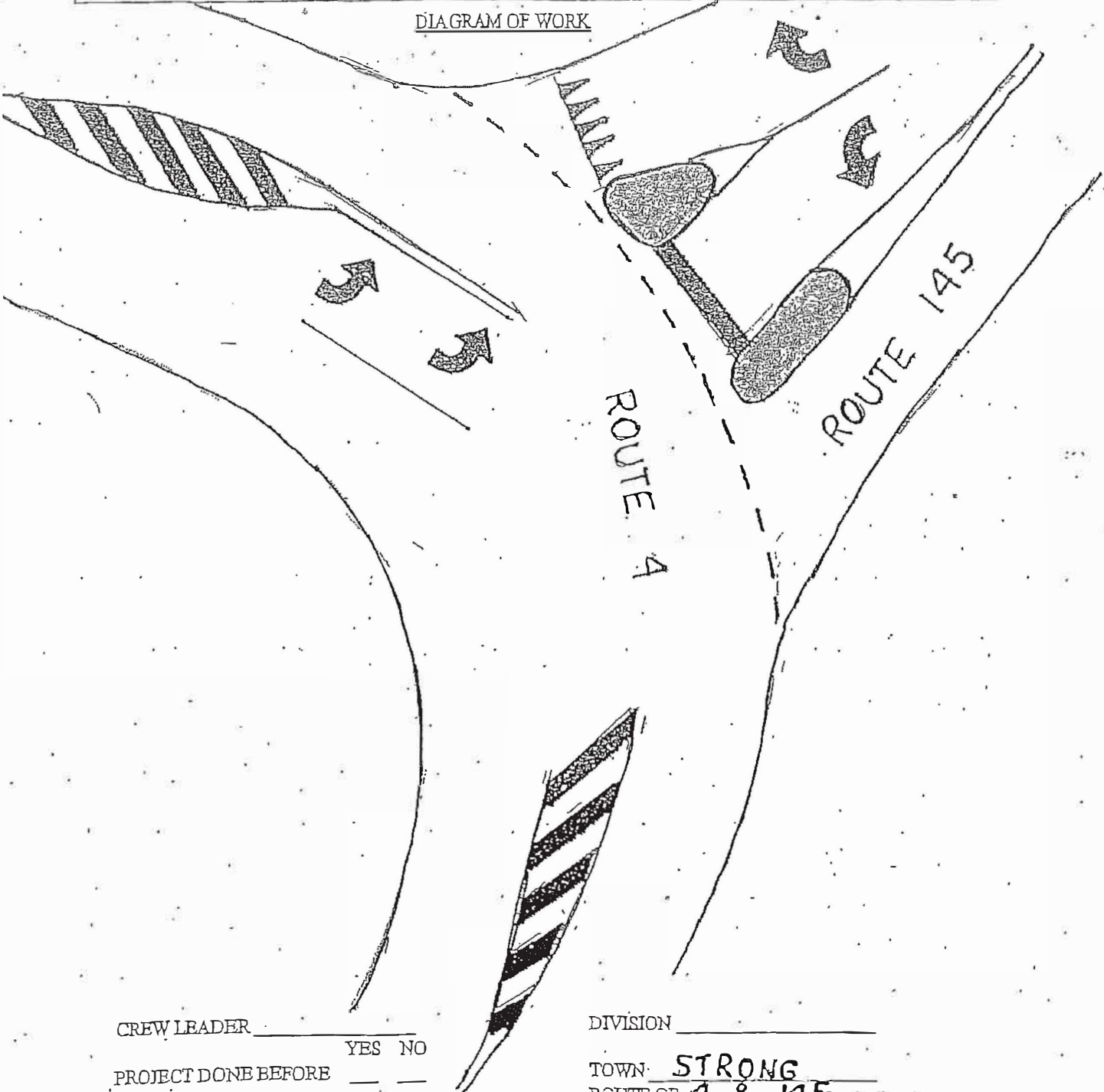

CREW LEADER _____

YES NO

PROJECT DONE BEFORE _____

DATE _____

ACTUAL JOB TIME _____

DIVISION _____

TOWN STRONG

ROUTE OR 4 & 145

ROAD NO. _____

PAVEMENT MARKINGS

Project No. _____

DESCRIPTION OF WORK DONE

Strong		Asset: 1081164
Total Sq. Feet:	108	Route 149 and Route 145
Stop Bar:	108	Map: 19

DIAGRAM OF WORK

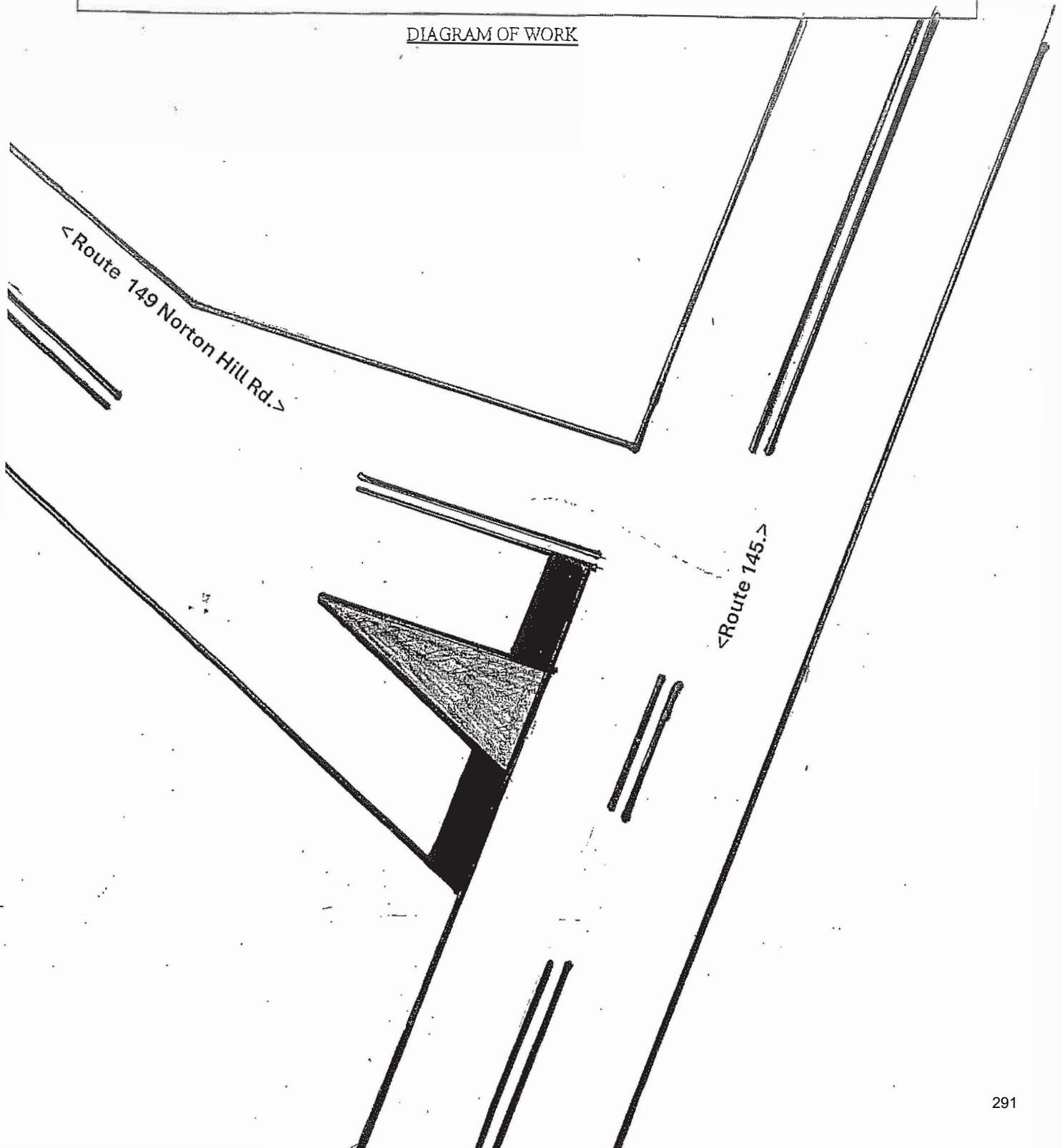

PAVEMENT MARKINGS

Project No. _____

DESCRIPTION OF WORK DONE

<u>Strong</u>		Asset: 1081166
Total Sq. Feet:	25	Route 149 and Route 145
Stop Bar:	25	Map: 19

DIAGRAM OF WORK

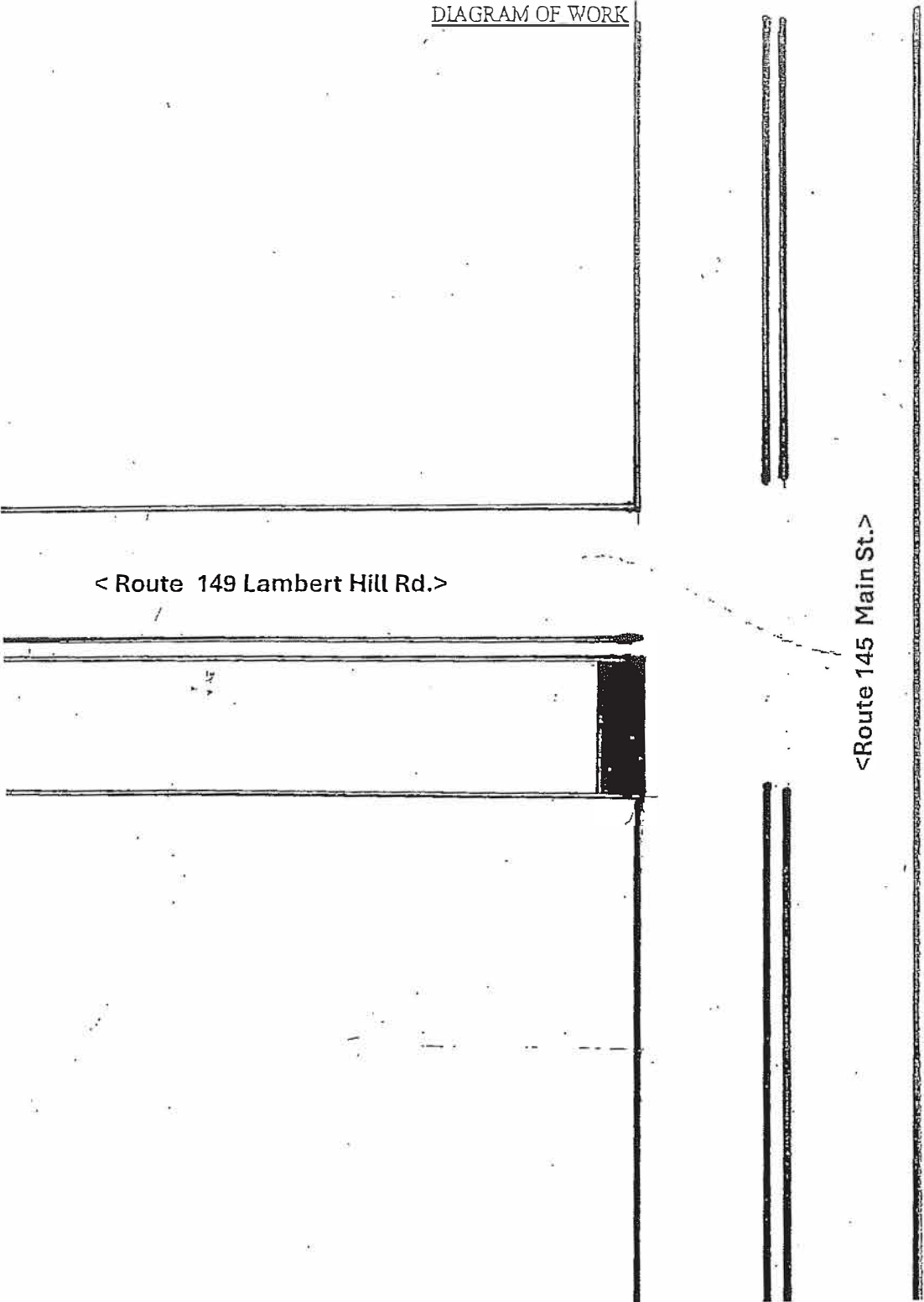

PAVEMENT MARKINGS

Project No. _____

1034448

DESCRIPTION OF WORK DONE

STRAIGHT ARROW _____	LANE LINE _____
TURN ARROW _____	STOP _____
STOP BAR _____	ONLY _____
CURBING-YELLOW _____	STOP AHEAD _____
WHITE _____	CROSSWALKS _____
HASH MARKS _____	TOTAL SQ. FT. <u>21</u>
MISC. <u>YIELD BAR 21</u>	

DIAGRAM OF WORK



CREW LEADER _____ YES NO

PROJECT DONE BEFORE _____

DATE _____

ACTUAL JOB TIME _____

DIVISION _____

TOWN TEMPLE

ROUTE OR 43 & INTERVALE

ROAD NO. _____

PAVEMENT MARKINGS

905143

Project No. _____

DESCRIPTION OF WORK DONE

STRAIGHT ARROW _____	LANE LINE _____
TURN ARROW _____	STOP _____ 22
STOP BAR _____ 70	ONLY _____
CURBING-YELLOW _____	STOP AHEAD _____ 37
WHITE _____	CROSSWALKS _____
HASH MARKS _____	TOTAL SQ. FT. _____ 129
MISC. _____	

DIAGRAM OF WORK

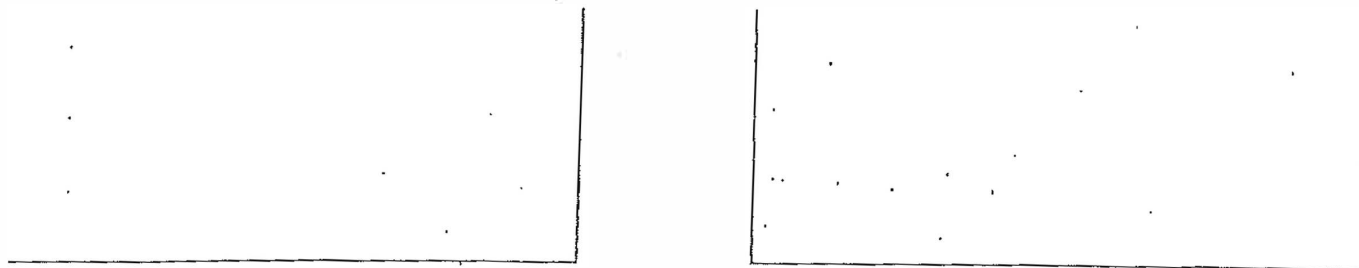

← RTE. 219 →



HOWES CORNER

STOP

STORE

RTE. 117



AHD STOP

CREW LEADER _____

REGION 3

YES NO

PROJECT DONE BEFORE _____

TOWN TURNER

DATE _____

ROUTE OR 117 & 219

ACTUAL JOB TIME _____

ROAD NO.

Total Sq Ft: 558

Stop AHD: 74

Stop Bar: 60

Yellow Hash: 312

Turn Arrow: 112

Route 4 and 219

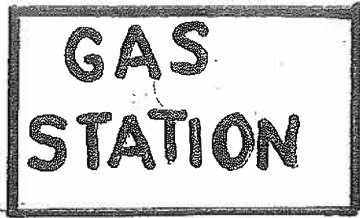

Route 219 Bear Pont Rd

AHD
STOP

Route 4

Route 4

Route 219 Howes Corner Rd

AHD
STOP

PAVEMENT MARKINGS

905154

Project No. _____

DESCRIPTION OF WORK DONE

STRAIGHT ARROW _____	LANE LINE _____
TURN ARROW _____	STOP : <u>88</u>
STOP BAR <u>200</u>	ONLY _____
CURBING-YELLOW _____	STOP AHEAD <u>74</u>
WHITE _____	CROSSWALKS _____
HASH MARKS _____	TOTAL SQ. FT. <u>362</u>
MISC. _____	

DIAGRAM OF WORK

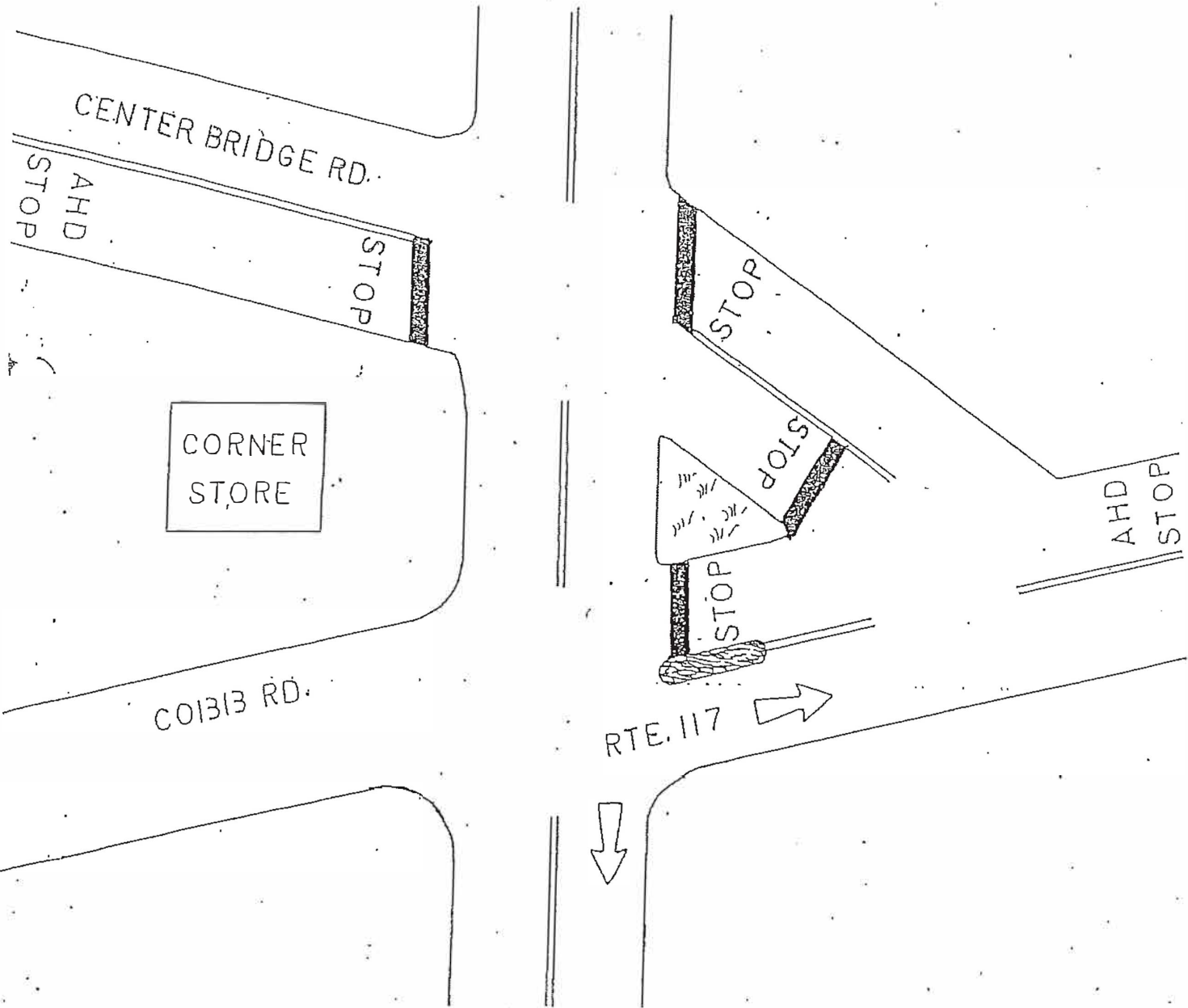

CREW LEADER _____
 YES NO
 PROJECT DONE BEFORE _____
 DATE _____
 ACTUAL JOB TIME _____

REGION 3

TOWN TURNER CENTER
 ROUTE OR 117 & ALLEN POND RD.
 ROAD NO. _____

PAVEMENT MARKINGS

Project No. _____

1034450

DESCRIPTION OF WORK DONE

STRAIGHT ARROW _____	LANE LINE _____
TURN ARROW _____	STOP _____
STOP BAR <u>162</u>	ONLY _____
CURBING-YELLOW _____	STOP AHEAD _____
WHITE _____	CROSSWALKS _____
HASH MARKS _____	TOTAL SQ. FT. <u>195</u>
MISC. <u>YIELD BAR 33</u>	

DIAGRAM OF WORK

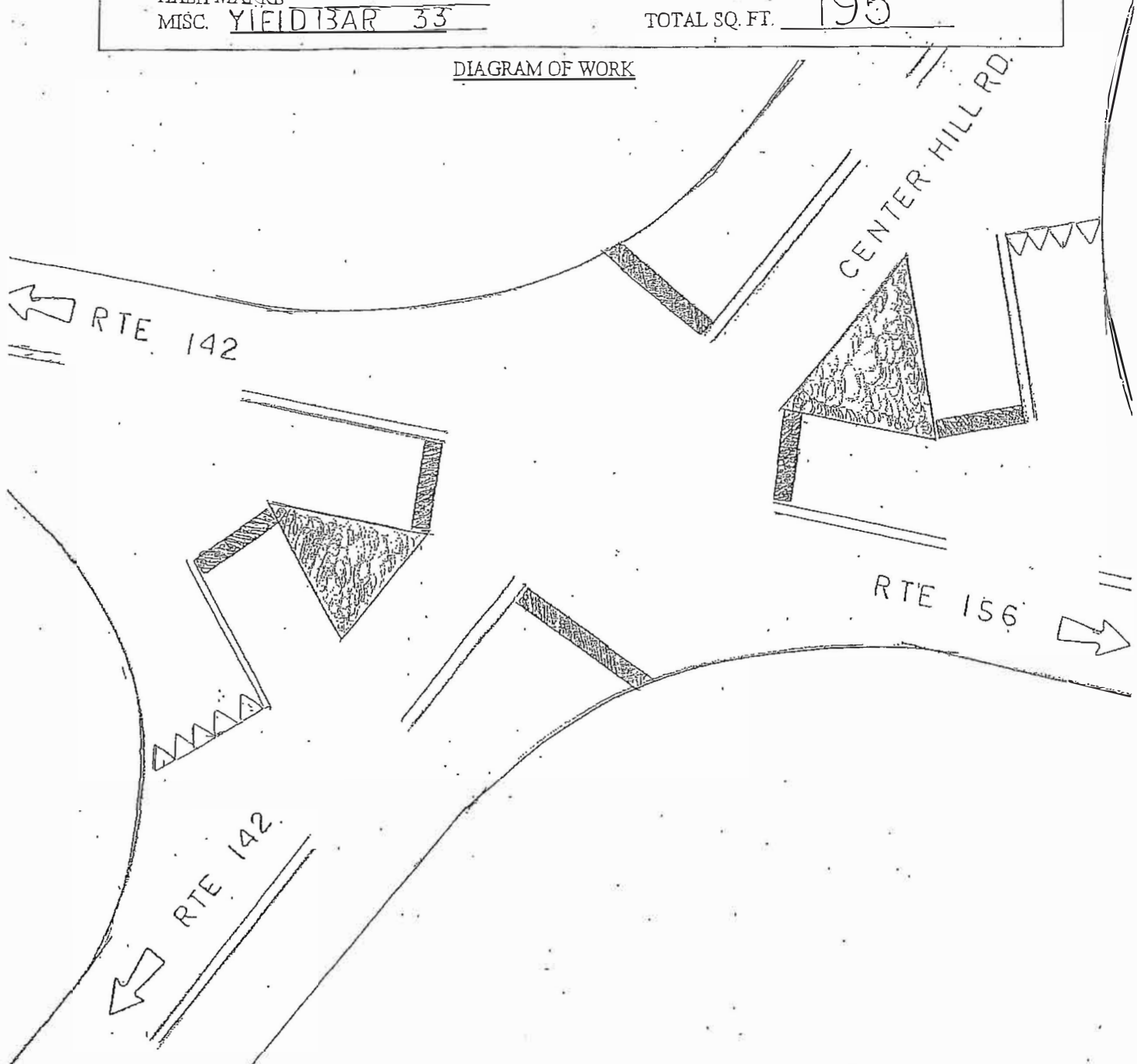

CREW LEADER _____ YES NO

DIVISION _____

PROJECT DONE BEFORE _____

TOWN WELD

DATE _____

ROUTE OR 156 & 142

ACTUAL JOB TIME _____

ROAD NO.

PAVEMENT MARKINGS

905161

Project No. _____

DESCRIPTION OF WORK DONE

STRAIGHT ARROW _____	LANE LINE _____
TURN ARROW _____	STOP _____
STOP BAR <u>52</u>	ONLY _____
CURBING-YELLOW _____	STOP AHEAD <u>37</u>
WHITE _____	CROSSWALKS _____
HASH MARKS _____	TOTAL SQ. FT. <u>89</u>
MISC. _____	

DIAGRAM OF WORK

TRAP
CORNER
STORE

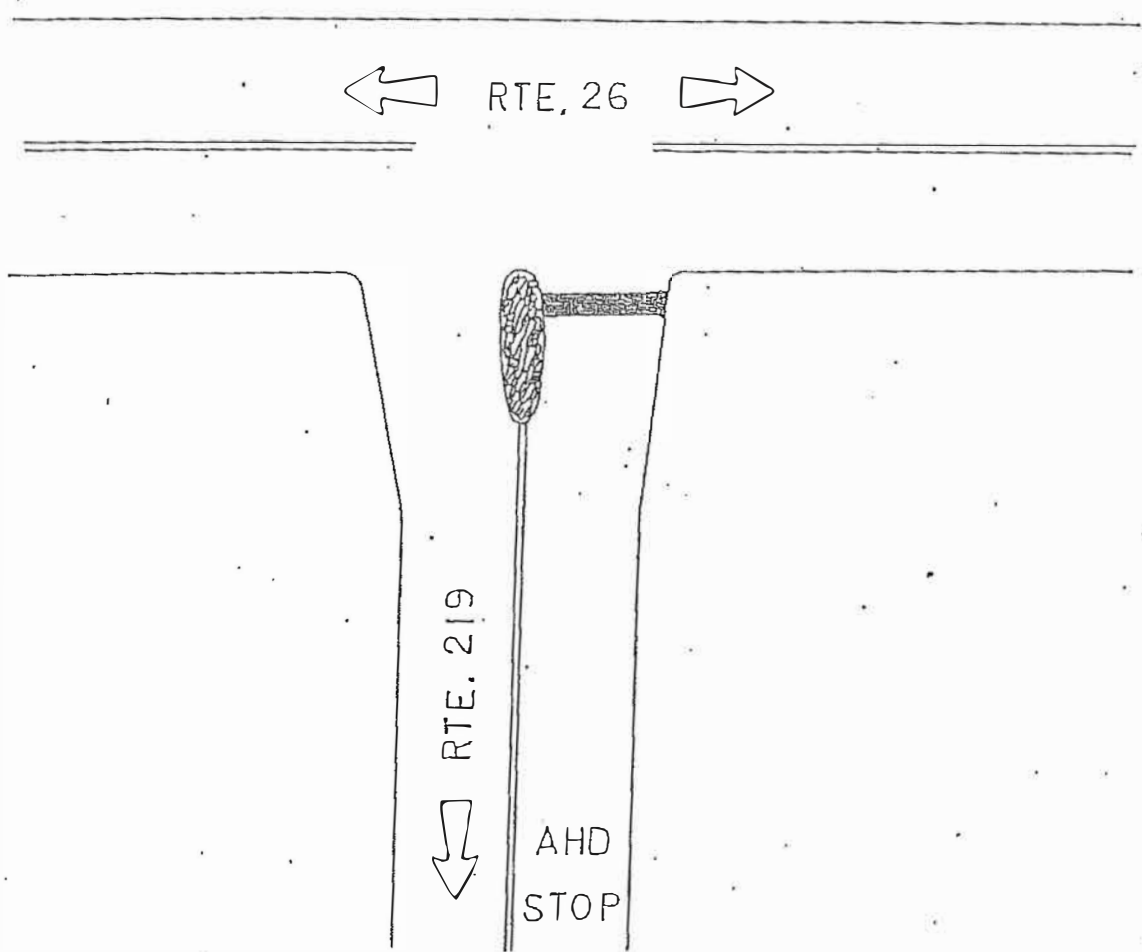

CREW LEADER _____ YES NO
PROJECT DONE BEFORE _____
DATE _____
ACTUAL JOB TIME _____

REGION 3

TOWN W. PARIS
ROUTE OR 26 & 219
ROAD NO. _____

PAVEMENT MARKINGS

Project No. 905163

DESCRIPTION OF WORK DONE

STRAIGHT ARROW	<u>39</u>	LANE LINE	_____
TURN ARROW	<u>32</u>	STOP	_____
STOP BAR	<u>110</u>	ONLY	_____
CURBING-YELLOW	<u>15</u>	STOP AHEAD	_____
WHITE	<u>50</u>	CROSSWALKS	_____
HASH MARKS	_____	TOTAL SQ. FT.	<u>333</u>
MISC. COMB. ARROWS	<u>87</u>		

DIAGRAM OF WORK

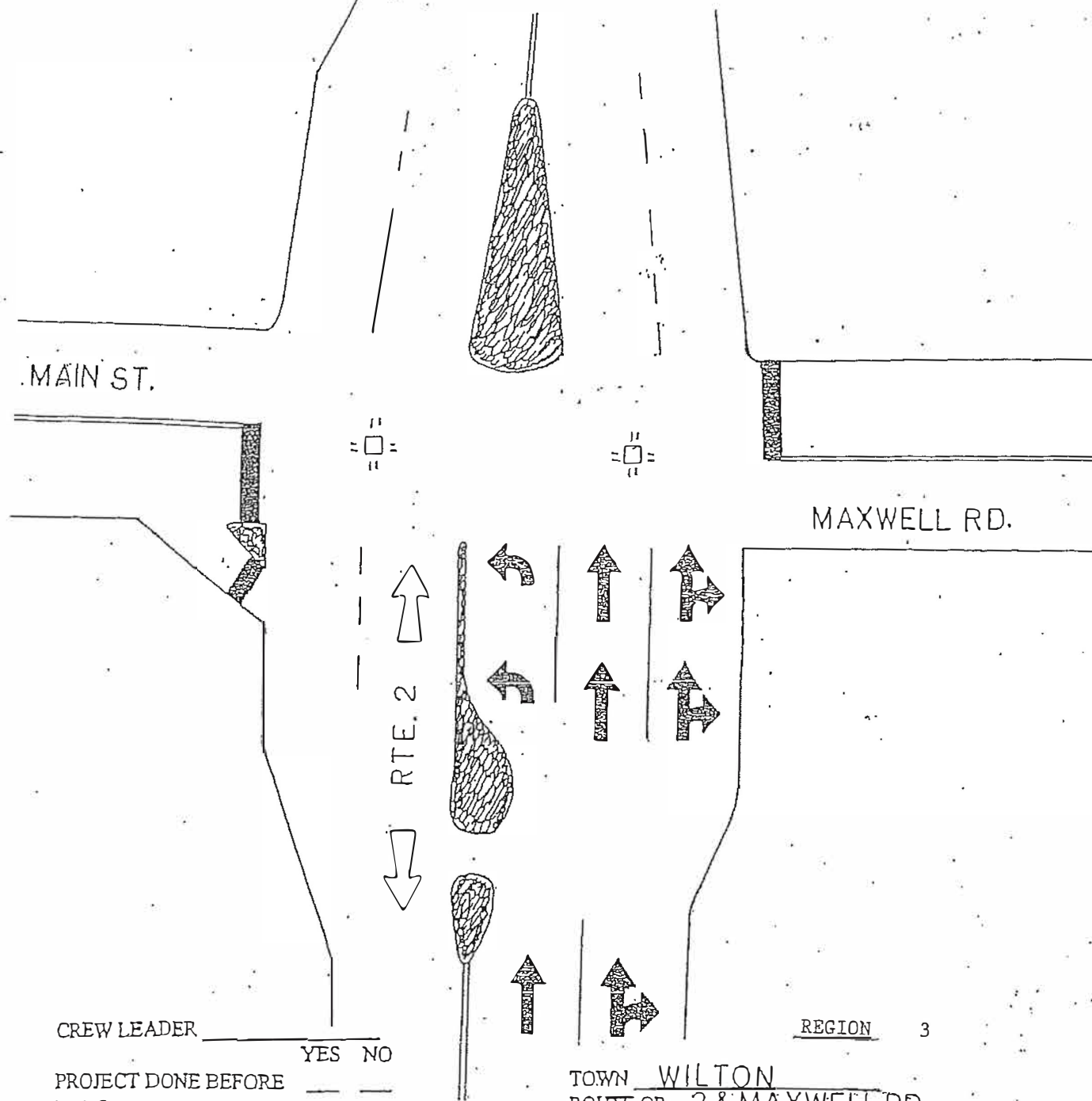

CREW LEADER _____
 YES NO
 PROJECT DONE BEFORE _____
 DATE _____
 ACTUAL JOB TIME _____

TOWN WILTON
 ROUTE OR 2 & MAXWELL RD.
 ROAD NO. MAIN ST.

REGION 3

PAYEMENT MARKINGS

Project No. 905165

DESCRIPTION OF WORK DONE

STRAIGHT ARROW	<u>39</u>	LANE LINE	_____
TURN ARROW	<u>208</u>	STOP	_____
STOP BAR	<u>100</u>	ONLY	<u>22</u>
CURBING-YELLOW	<u>80</u>	STOP AHEAD	_____
WHITE	<u>96</u>	CROSSWALKS	_____
HASH MARKS CHEVRON	<u>150</u>	TOTAL SQ. FT.	<u>782</u>
MISC. COMB. ARROW	<u>87</u>		

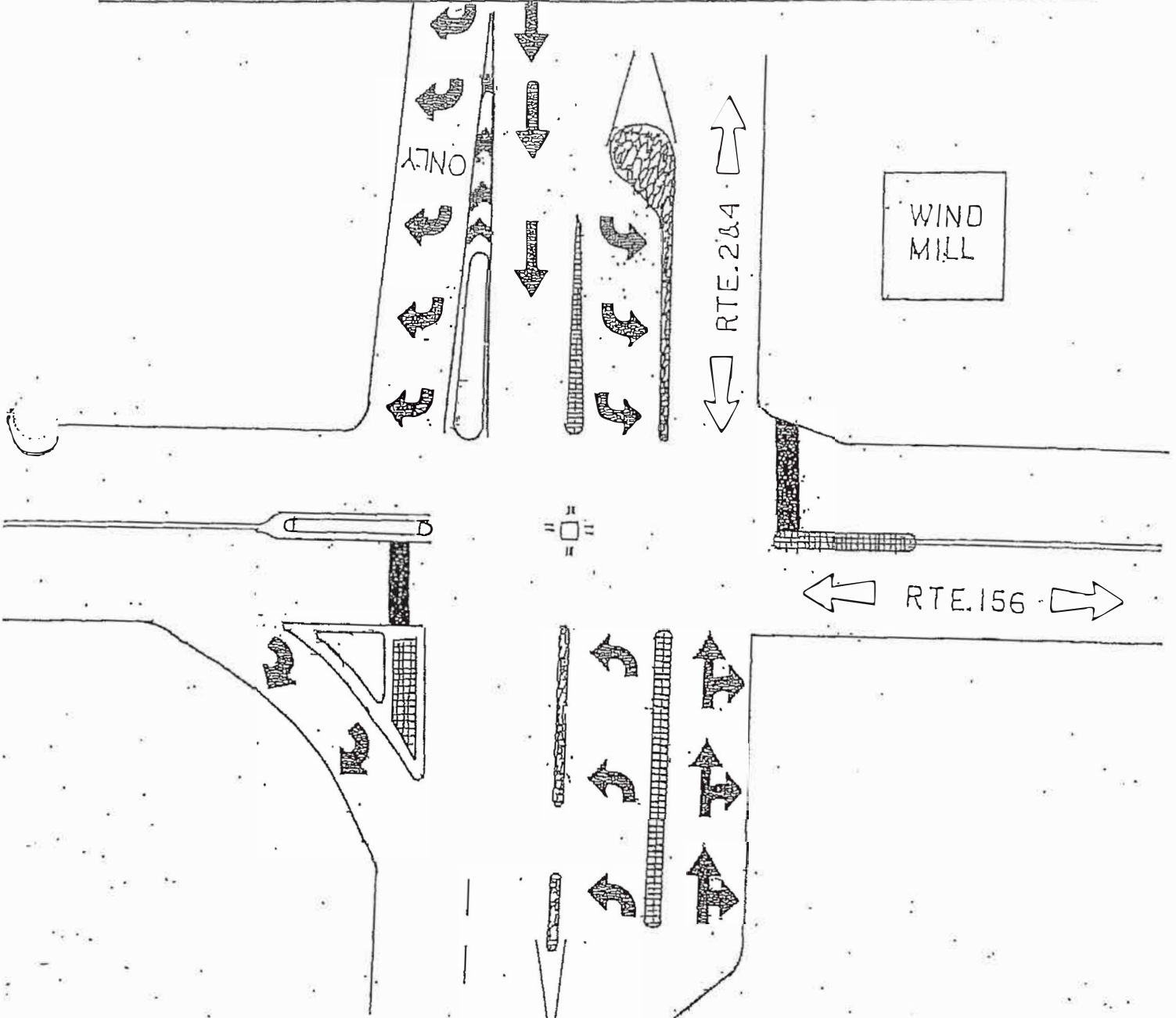

CREW LEADER _____
 YES NO
 PROJECT DONE BEFORE _____
 DATE _____
 ACTUAL JOB TIME _____

REGION 3
 TOWN WILTON / DRYDEN
 ROUTE OR 2 & 156
 ROAD NO. _____

PAVEMENT MARKINGS

Project No.

905167

DESCRIPTION OF WORK DONE

STRAIGHT ARROW	143	2 & 4	40
TURN ARROW	112	LANE LINE	
STOP BAR	86	STOP ONLY	22
CURBING-YELLOW		STOP AHEAD	37
WHITE		CROSSWALKS	
HASH MARKS		YIELD	25
MISC.		TOTAL SQ. FT.	492

YIELD BAR 27

DIAGRAM OF WORK

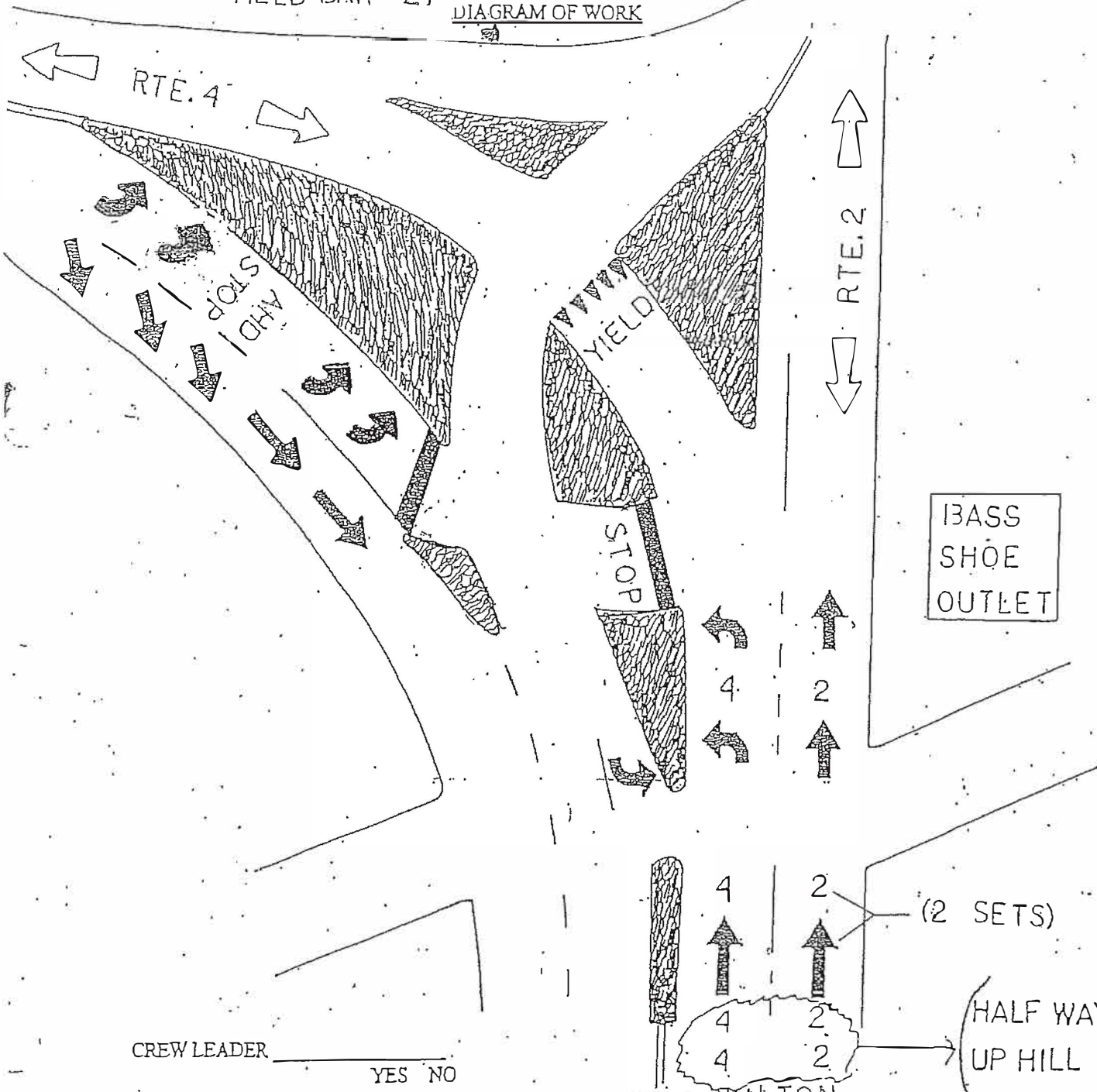

CREW LEADER _____ YES NO
 PROJECT DONE BEFORE _____
 DATE _____
 ACTUAL JOB TIME _____

TOWN WILTON
 ROUTE OR 2 & 4
 ROAD NO. _____ REGION 3

DESCRIPTION OF WORK DONE

725111

STRAIGHT ARROW _____	LANE LINE _____
TURN ARROW _____ 80 _____	STOP _____
STOP BAR _____	ONLY _____
CURBING-YELLOW _____	STOP AHEAD _____
WHITE _____ 121 _____	CROSSWALKS _____
HASH MARKS _____ 375 _____	TOTAL SQ. FT. _____ 634 _____
MISC. COMBOS _____ 58 _____	

DIAGRAM OF WORK

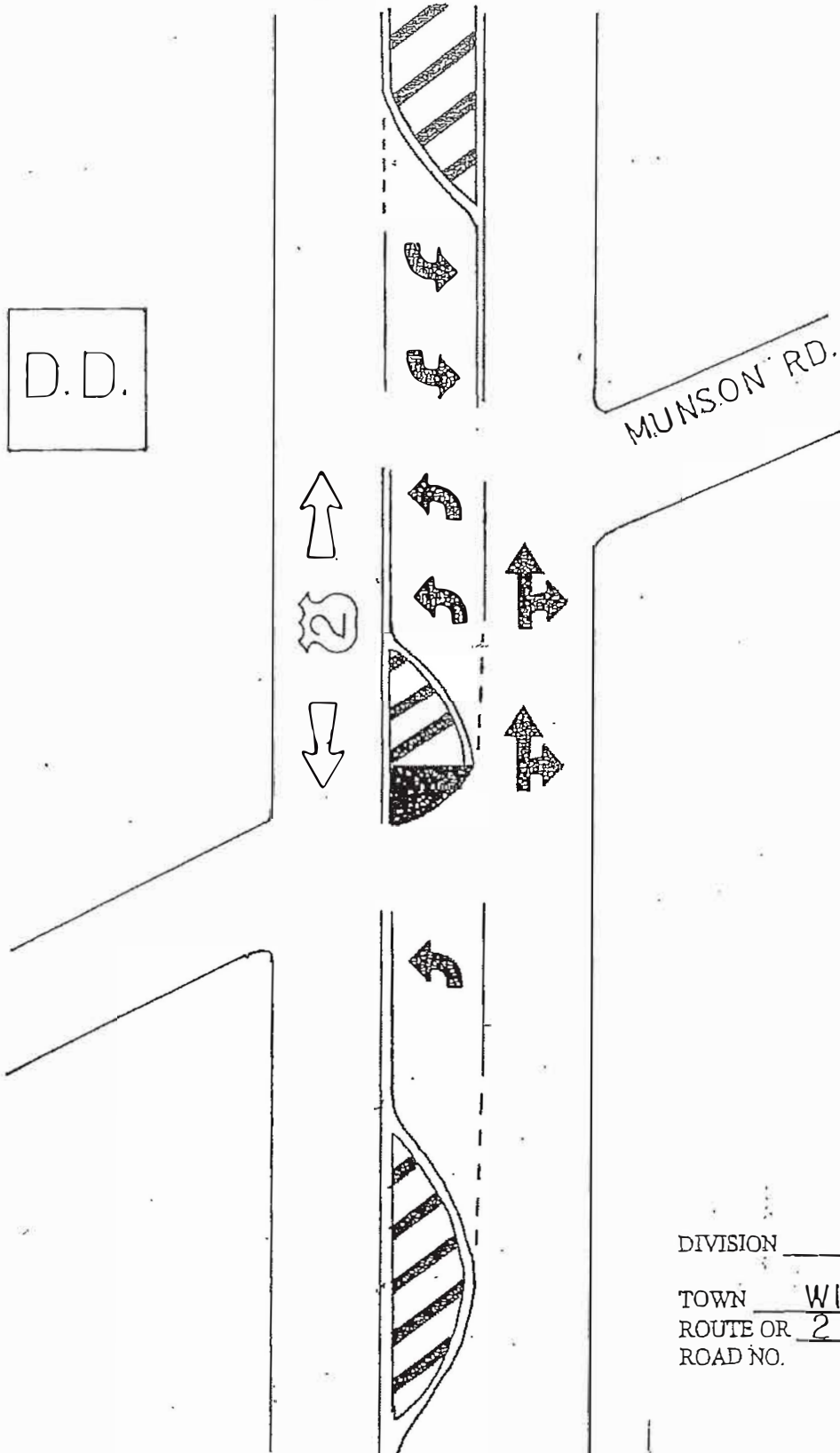

DIVISION _____

TOWN WILTON

ROUTE OR 2 & D.D.

ROAD NO. _____

SPECIAL PROVISION
SECTION 652
MAINTENANCE OF TRAFFIC

652.1 Description This work shall consist of furnishing, installing, maintaining and removing traffic control devices necessary to provide reasonable protection for motorists, pedestrians and construction workers in accordance with these Specifications. Traffic control devices include signs, signals, lighting devices, markings, barricades, channelizing, and hand signaling devices, traffic officers, and flaggers.

652.2 Materials All traffic control devices shall conform to the requirements of Part VI of the latest edition of the MUTCD, and latest edition of the MaineDOT Standard Specifications.

652.3.3 Submittal of a Traffic Control Plan The Contractor shall submit, before work on an assignment, a Modified Traffic Control Plan (TCP) that provides the following information to the Department:

- a. The name, telephone number, and other contact numbers (cellular phone, pager, if any) of the Contractor's Traffic Control Supervisor (TCS). The TCS is the person with overall responsibility for insuring the Contractor follows the TCP; and who has received Work Zone Traffic Control Training commensurate with the level of responsibility shown in the requirements of the Contract, and who is empowered to immediately resolve any work zone traffic control deficiencies or issues.
- b. A written narrative and/or plan explaining how traffic and pedestrians will be moved through the Project Limits, as applicable.

The Department will review the TCP for completeness and conformity with Federal requirements, Contract provisions, the current edition of the MUTCD, and Department policy and procedures. The Department will review and provide comments to the Contractor within 7 days of receipt of the TCP. No review or comment by the Department, or any failure to review or comment, shall operate to absolve the Contractor of its responsibility to design and implement the plan in accordance with the Contract, or to shift any responsibility to the Department. If the TCP is determined by the Department to be operationally ineffective, the Contractor shall submit modifications of the TCP to the Department for review and shall implement these changes at no additional cost to the Contract. Nothing in this Section shall negate the Contractor's obligations set forth in Section 110 - Indemnification, Bonding, and Insurance. The creation and modification of the TCP will be considered incidental to the related 627 items.

652.3.4 General No equipment or vehicles of the Contractor, their subcontractors, or employees engaged in work on this contract shall be parked or stopped on lanes carrying traffic, or on lanes or shoulders adjacent to lanes carrying traffic, at any time, except as required by ongoing work operations.

652.8 Basis of Payment Failure by the Contractor to follow the Manual on Uniform Traffic Control Devices (MUTCD) and/or the Contractor's own Traffic Control Plan will result in a violation letter and result in a reduction in payment as shown in the schedule below. The Department reserves the right to suspend the Work at any time and request a meeting to discuss violations and remedies. The Department shall not be held responsible for any delay in the Work due to any suspension under this item.

Amount of Penalty Damages per Violation

<u>1st</u>	<u>2nd</u>	<u>3rd & Subsequent</u>
\$250	\$500	\$1,250

Maintenance of Traffic will not be paid for separately and shall be considered incidental to the 627 items.

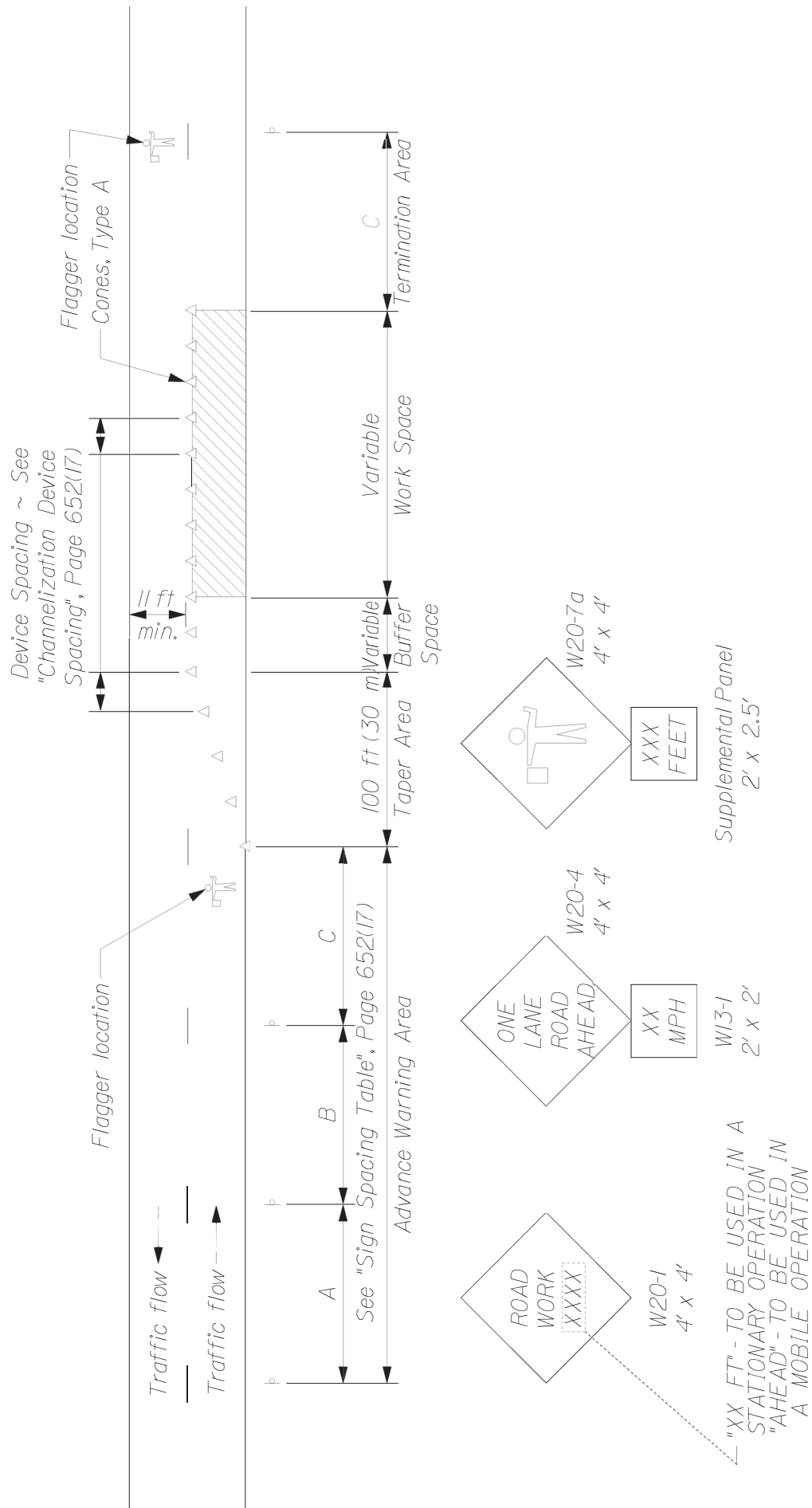

TYPICAL APPLICATION: TWO - WAY, TWO LANE ROADWAY, CLOSING ONE LANE USING FLAGGERS

* Formulas for L are as follows:

For speed limits of 40 mph (60 km/h) or less:

$$L = \frac{WS^2}{60} \quad (L = \frac{WS^2}{155})$$

For speed limits of 45 mph (70 km/h) or greater:

$$L = WS \quad (L = \frac{WS}{1.6})$$

* Formulas for L are as follows:

A minimum of 5 channelization devices shall be used in the taper.

TYPE OF TAPER	TAPER LENGTH (L)*
Merging Taper	at least L
Shifting Taper	at least 0.5L
Shoulder Taper	at least 0.33L
One-Lane, Two-Way Traffic Taper	100 ft (30 m) maximum
Downstream Taper	100 ft (30 m) per lane

CHANNELIZATION DEVICE SPACING

The spacing of channelization devices shall not exceed a distance equal to 1.0 times the speed limit in mph when used for taper channelization, and a distance in feet of 2.0 times the speed limit in mph when used for tangent channelization.

GENERAL NOTES;

1. Final placement of signs and devices may be changed to fit field conditions as approved by the Resident.

Road Type	Distance Between Signs**		
	A	B	C
Urban 30 mph (50 km/h) or less	100 (30)	100 (30)	100 (30)
Urban 35 mph (55 km/h) and greater	350 (100)	350 (100)	350 (100)
Rural	500 (150)	500 (150)	500 (150)
Expressway / Urban Parkway	2,640 (800)	1,500 (450)	1000 (300)

**Distances are shown in feet (meters).

SUGGESTED BUFFER ZONE LENGTHS

Speed (mph)	Length (feet)	Speed (mph)	Length (feet)
20	115	40	325
25	155	45	360
30	200	50	425
35	250	55	495

SPECIAL PROVISIONS
ADDITIONS AND REVISIONS TO STANDARD SPECIFICATIONS

SPECIAL PROVISION SECTION 101
CONTRACT INTERPRETATION

101.2 Definitions Add the following:

“MaineDOT The Department of Transportation of the State of Maine, as established by 23 MRSA §4205 et seq. for the administration of Highway, Bridge, and other public Works; acting through the Commissioner and his/her duly authorized representatives.”

SPECIAL PROVISION SECTION 102
BIDDING

102.7.1 Location and Time Delete the entire section and replace with the following:

“The Bidder must Deliver its Bid and Bid Guaranty in a sealed envelope to the exact location and before the precise time (as determined by the Department) specified in the Notice to Contractors or any applicable Bid Amendment. The sealed envelope must be labeled with the Bidder's name, the Work location, WIN and Title, and the words “Bid Enclosed”. As a minimum, the Bidder will submit a Bid Package consisting of the Notice to Contractors, the completed Acknowledgement of Bid Amendments form, the completed Schedule of Items, 2 copies of the completed Contract form, and any other Certifications or Bid Requirements listed in the Bid Book. For a related provision, see Section 102.11 - "Bid Responsiveness".

Electronic Bids must be submitted to the appropriate electronic bid system before the precise time (as determined by the Department) specified in the Notice to Contractors or any applicable Bid Amendment.”

102.11.1 Non-curable Bid Defects Revise the item on the list of non-curable Bid Defects for which the Department will reject Bids as non-responsive that reads “The Bid is not signed by a duly authorized representative of the Bidder.” by replacing it with the following:

“The Bid is not signed by a duly authorized representative of the Bidder.

- Properly submitted electronic bids meet this requirement.
- Paper bids must include either (1) one or more signed copies of the Contract Agreement form or (2) a signed copy of the Schedule of Items.”

102.11.1 Non-curable Bid Defects Revise this subsection by removing the words “The unit price and bid amount is not provided or a lump sum price is not provided or is illegible as determined by the Department.” and replacing it with the following:

“The unit price and bid amount is not provided if (1) the item quantity is not one or lump sum or, (2) the lump sum contract price is not provided or, (3) the unit price, bid amount or lump sum price is illegible as determined by the Department.”

102.11.2 Curable Bid Defects Revise the section by replacing it with the following:

“Unless the Department waives a curable Bid defect, the Bidder must cure, within the time stated in the written notice by the Department, but not less than 24 hours, all other Bid Defects not listed in Section 102.11.1 - Non-curable Bid Defects that are identified by the Department. Failure to cure such Defects within said time may result in forfeiture of the Bidder’s Bid Guaranty. Upon such failure, the Department may take any action in the best interests of the Department, including those set forth in Section 103.6 - Failure to Fulfill Award Conditions.

Such curable Bid Defects include, but are not limited to, the following.

The Bidder signs only one of the Contract Agreement Offer & Award forms.

Missing total sum of the items provided in the Schedule of Items.

The prices or signatures on the Bid or Bid Guaranty are not in ink or other non-erasable substance.

Failure to acknowledge Receipt and consideration of all Bid Amendments.

The Bid includes only one signed Contract Agreement form.

The Bid does not include a signed Contract Agreement form but does include a signed Schedule of Items.

If a submitted bid contains any additional conditions or alternate bidding language, the Bidder may cure the defect by removing all conditions and alternate language or the Department will reject the bid as non-responsive.

All other Defects that do not create a significant question as to the Bidder’s total Bid amount or the Bidder’s ability to complete the Work within the Contract Time or by the Contract Completion Date as determined by the Department.”

SPECIAL PROVISION SECTION 103
AWARD AND CONTRACTING

103.1.1 Unit Prices Govern Add the following at the end of the paragraph:

“If the item quantity is one and either a unit price or bid amount is not provided, the unit price or bid amount omitted shall be determined mathematically by the Department.”

103.5 Award Conditions Replace the first paragraph with the following:

“The Apparent Successful Bidder must provide and/or perform all of the items listed in this Section 103.5 within 14 Days of Receipt of the Notice of Intent to Award. Unless indicated otherwise, all items must be Delivered to the Department’s Bureau of Maintenance & Operations.”

103.5.4 Execution of Contract By Bidder Delete the entire section and replace with the following:

“The properly completed and signed Contract form provided with the Bid constitutes the Bidder’s offer. Once the Department has received the bonds (if applicable), insurance, and any other pre-award items required, the Department will sign and execute the Contract. The point of Contract execution is when the Contractor receives written notice that the contract has been signed by the Department and executed.”

SPECIAL PROVISION SECTION 109
CHANGES

109.1.2 Substantial Changes to Major Items Delete the entire section.

109.2 Elimination of Items Delete the entire section.

2020 STANDARD DETAIL UPDATES

Standard Details and Standard Detail updates are available at:
<http://maine.gov/mdot/contractors/publications/standarddetail/>

<u>Detail #</u>	<u>Description</u>	<u>Posted Date</u>
502(06)	Concrete Sidewalk on Bridges	9/22/2025
502(19)	Bridge Drains	3/17/2023
502(15)	Bridge Drains	3/17/2023
502(20)	Bridge Drains	3/17/2023
502(23)	Bridge Drains	3/17/2023
502(24)	Bridge Drains	3/17/2023
502(25)	Bridge Drains	3/17/2023
502(26)	Bridge Drains	3/17/2023
504(07)	Diaphragm & Crossframe Notes	3/17/2023
507(04)	Steel Bridge Railing	9/22/2025
507(05)	Steel Bridge Railing	9/22/2025
507(06)	Steel Bridge Railing	9/22/2025
507(07)	Steel Bridge Railing	9/22/2025
507(14)	Steel Bridge Railing	9/22/2025
507(15)	Steel Bridge Railing	9/22/2025
507(20)	Steel Approach Railing 3-Bar	2/11/2021
507(21)	Steel Approach Railing 3-Bar	2/11/2021
507(22)	Steel Approach Railing, 3 Bar	9/22/2025
507(23)	Steel Approach Railing, 3 Bar	9/22/2025
507(26)	Steel Approach Railing, 3 Bar	9/22/2025
507(27)	Steel Approach Railing	9/22/2025
507(39)	Barrier – Mounted Steel Bridge Rail	9/22/2025
526(01)	Portable Concrete Barrier	1/14/2021
526(01A)	Portable Concrete Barrier	1/14/2021
526(01B)	Portable Concrete Barrier	1/14/2021
526(02)	Portable Concrete Barrier	1/14/2021
526(02A)	Portable Concrete Barrier	1/14/2021
526(03)	Portable Concrete Barrier	1/14/2021
526(04)	Portable Concrete Barrier	1/14/2021

526(04A)	Portable Concrete Barrier	1/14/2021
526(04B)	Portable Concrete Barrier	1/14/2021
526(05)	Permanent Concrete Barrier	3/17/2023
526(21)	Permanent Concrete Barrier	3/17/2023
526(22)	Concrete Transition Barrier	9/22/2025
526(23)	Concrete Transition Barrier	9/22/2025
526(23)A	Concrete Transition Barrier	9/22/2025
526(34)	Concrete Transition Barrier	9/22/2025
526(35)	Concrete Transition Barrier	9/22/2025
526(36)	Concrete Transition Barrier	9/22/2025
526(37)	Concrete Transition Barrier	9/22/2025
526(37) A	Concrete Transition Barrier	9/22/2025
526(38)	Concrete Transition Barrier	9/22/2025
526(39)	Texas Classic Rail	3/17/2023
526(55)	Texas Classic Rail	3/17/2023
603(10)	Concrete Pipe Ties	6/10/2021
605(01)	Underdrain	7/8/2022
605(01)	Underdrain Notes	7/8/2022
606(17)	Midway Splice Guardrail Transition	6/10/2022
606(21)	Guardrail Type 3 – Single Rail Bridge Mounted	9/22/2025
606(22)	Guardrail Treatment over Buried Structures	9/22/2025
606(23)	Standard Bridge Transition – Type “1”	2/11/2021
606(24)	Bridge Transition – Type “1A”	9/22/2025
606(25)	Bridge Transition – Type “2”	9/22/2025
607(10)	Snow Fence Details (New Detail)	9/22/2025
607(11)	Snow Fence Details (New Detail)	9/22/2025
607(12)	Snow Fence Details (New Detail)	9/22/2025
607(13)	Snow Fence Details (New Detail)	9/22/2025
607(14)	Snow Fence Details (New Detail)	9/22/2025
607(15)	Snow Fence Details (New Detail)	9/22/2025
607(16)	Snow Fence Details (New Detail)	9/22/2025
608(02)	Detectable Warnings	6/10/2021
609(08)	Precast Concrete Transition Curb	9/22/2025
609(09)	Precast Concrete Vertical Curb	9/22/2025
627(07)	Crosswalk	2/22/2022
627(08)	Crosswalk	2/22/2022

643(11)	ATCC Cabinet	12/14/2020	
645(06)	H Beam Posts Highway Signing	12/17/2024	
645(21)	Overpass Mounted Sign Support Highway Signing	9/22/2025	
645 (22)	Overpass Mounted Sign Support Highway Signing	9/22/2025	
<u>801(10)</u>	<u>Pavement Transition at Bridge</u>	<u>DISCONTINUE THIS STD DETAIL</u>	<u>9/22/2025</u>
801(11)	Pedestrian Ramp Notes	11/20/2023	
801(12)	Pedestrian Ramp Requirements	11/20/2023	
801(13)	Ramp Length Table	11/20/2023	
801(14)	Parallel Pedestrian Ramp	11/20/2023	
801(15)	Perpendicular Pedestrian Ramp – Option 1	11/20/2023	
801(16)	Parallel Pedestrian Ramp – Option 2A	11/20/2023	
801(17)	Perpendicular Pedestrian Ramp – Option 2A	11/20/2023	
801(18)	Parallel Pedestrian Ramp – Option 2B	11/20/2023	
801(19)	Perpendicular Pedestrian Ramp – Option 2B	11/20/2023	
801(20)	Parallel Pedestrian Ramp – Option 3	11/20/2023	
801(21)	Perpendicular Pedestrian Ramp – Option 3	11/20/2023	
801(22)	Side Street Pedestrian Ramp	11/20/2023	
801(23)	Parallel Pedestrian Ramp – Esplanade	11/20/2023	
801(24)	Perpendicular Pedestrian Ramp – Esplanade	11/20/2023	
801(25)	Island Crossings	11/20/2023	
801(26)	Blended Transition	11/20/2023	
801(26)	Blended Transition	1/19/2024	
801(27)	Pedestrian Ramp Adjacent to Driveway or Entrance	11/20/2023	
802(05)	Roadway Culvert End Slope Treatment	1/03/2017	
802(05)	Roadway Culvert End Slope Treatment	11/01/2024	

SUPPLEMENTAL SPECIFICATIONS
(Corrections, Additions, & Revisions to Standard Specifications – March 2020)

SECTION 101
CONTRACT INTERPRETATION

101.2 Definitions

Construction Easement revise this definition by removing it in its entirety and replace with:
“A right acquired by the Department for a specific use of private property outside of the established Right-of-Way. Examples include but are not limited to Drainage Easements, Construction and Maintenance Easements, and Slope Easements. Construction Easement areas, including Temporary Construction Limits and Temporary Road Limits, outside of the Right-of-Way remain private property. No use other than to access and perform the specified work activity is permitted without written permission of the owner.”

Construction Limit Line Remove this definition in its entirety.

Holidays Amend this paragraph by adding “**Juneteenth**” between ‘Memorial Day’ and ‘Independence Day’.

Plans Revise this paragraph by removing “**Standard Details, Supplemental Standard Details**” from the first sentence.

Project Limits Revise this definition by removing it in its entirety and replacing it with:
“Areas within the Right-of-Way, Construction Easements, or Temporary Construction Limits shown on the Plans or otherwise indicated in the Contract. If no Project Limits are indicated in the Contract, the Project Limits shall be determined by the Department. For a related Maine statute, see 23 MRSA § 653. “

Right-Of-Way Revise this definition by removing it in its entirety and replacing it with:
“The area of land, property, or interest therein, acquired for or devoted to the Project or other purposes. Portions of the Right-of-Way may be used for storage of materials and equipment and the location of engineering facilities, subject to written approval by the Department.”

Amend this Section by adding the following two definitions (that replace Construction Limit Line);

Temporary Construction Limits **The area within which the Contractor may access and perform the Physical Work and outside of which Work may not be performed without written authorization by the property owner.**

Temporary Road Limits **The area within which the Contractor may construct and maintain a temporary detour for maintenance of traffic.**

SECTION 102 BIDDING

102.11 Bid Responsiveness Revise the paragraph that states
“The Bid is not signed by a duly authorized representative of the Bidder.” So that it reads:

“The Bid is not signed by a duly authorized representative of the Bidder.

- Properly submitted electronic bids meet this requirement.
- Paper bids must include at least one signed copy of the Contract Agreement Offer & Award form.”

SECTION 103 AWARD AND CONTRACTING

103.3.1 Qualification Requirement for Award Revise this subsection so that it reads:

“**103.3.1 Qualification Requirement for Award** If the Notice to Contractors lists a Prequalification requirement, the Apparent Successful Bidder must successfully complete the Prequalification process as a condition of Award. The Apparent Successful Bidder who does not already hold an Annual Prequalification shall have 21 days to provide the Department with their Prequal documents or the Department may move on to the next low bidder.”

SECTION 104 GENERAL RIGHTS AND RESPONSIBILITIES

104.2.1 Furnishing of Right-of-Way Revise this subsection by removing it in its entirety and replace with the new subsection:

“**104.2.1 Furnishing of Property Rights** The Department will secure all necessary rights to real property within the Project Limits shown on the Right-of-Way Plans that are provided with the Bid Documents. For related provisions, see Sections 104.3.2 – Furnishing of Other Property Rights, Licenses and Permits and 105.4.5 - Maintenance of Existing Structures. For related definitions, see Construction Easements and Right-of-Way.”

104.3.2 Furnishing of Other Property Rights, Licenses and Permits Revise this subsection by replacing “104.2.1 Furnishing of Right-of-Way” with “**104.2.1 Furnishing of Property Rights**”.

SECTION 105 GENERAL SCOPE OF WORK

Amend this Section by adding this new sub-section:

105.8.8 Protected Species If the Contractor witnesses a bat (dead or alive), any activities that may injure any live bats must cease immediately and the Contractor shall contact the

Resident. Dead and/or injured bats will be collected by the Department. Work in the vicinity of the live/dead bat sighting will not resume until the Department confirms it is acceptable to do so.

If the Contractor observes an active bird nest within the project limits, any activities that may disturb the nest or injure birds (i.e., nesting adults, chicks, eggs) must cease immediately, and the Contractor shall contact the Resident.

Amend this Section by adding this new sub-section to cover incidents in the field:

105.6.5 Survey Control Markers If a survey control marker will be disturbed by Work on a project, the Resident shall be informed a minimum of 2 weeks prior to performing any Work that may disturb the marker. If a survey control marker is accidentally disturbed by Work on a project, the Resident shall be informed immediately. A disturbed marker will remain the property of the Department.

105.10.1.4 Race-conscious Project Goals Revise the second paragraph of this section so it reads as follows:

“At the time of the bid opening, all Bidders shall submit with their bid a Disadvantaged Business Enterprise (DBE) Commitment Form provided by the Department. This form will list the DBE and non-DBE firms that are proposed to be used during the execution of the Work. This form must be filled out in its entirety. The dollar total of each commitment shall be totaled and a percentage determined.”

105.10.2 Requirements Applicable to All Contracts Under section A, number 2, in the first sentence of the first paragraph, revise this Section by replacing the word “handicap” in two places with the word “disability” so it now reads:

“2) The Contractor will, in all solicitations or advertisements for employees placed by or on behalf of the Contractor, State that all qualified applicants will receive consideration for employment without regard to race, color, sexual orientation, religious creed, sex, national origin, ancestry, age, physical disability, or mental disability.”

105.10.1.6 Bidders’ List Survey This section shall be revised to meet the May 9, 2024 CFR changes as follows:

Revise the title of this Section to “**Bidders’ List**” by removing the word “**Survey**”.

Revise the current information required to:

- (i) Firm name;**
- (ii) Firm address including ZIP code;**
- (iii) Firm's status as a DBE or non-DBE;**
- (iv) Race and gender information for the firm's majority owner;**
- (v) NAICS code applicable to each scope of work the firm sought to perform in its bid;**
- (vi) Age of the firm; and**

(vii) The annual gross receipts of the firm. You may obtain this information by asking each firm to indicate into what gross receipts bracket they fit (e.g., less than \$1 million; \$1-3 million; \$3-6 million; \$6-10 million; etc.) rather than requesting an exact figure from the firm.

Revise this section by removing the paragraph beginning with “This information...” and replacing it with the following:

“This data is required from all bidders for federally assisted contracts to be submitted with their bids as this information is critical in determining the availability of DBE Businesses relative to other businesses that do similar work.”

SECTION 106
QUALITY

106.6 Acceptance Revise this Subsection by replacing the paragraph beginning with “Acceptance of Hot Mix Asphalt Pavement will be based” with:

“Acceptance of Hot Mix Asphalt Pavement will be based on Method A or C Statistical Acceptance, or Method B or D Acceptance as specified. The method of acceptance for each item is defined in Special Provision, Section 403, Hot Mix Asphalt Pavement. When items of Hot Mix Asphalt Pavement are not so designated, Method A will be utilized whenever there are more than 1000 tons per Hot Mix Asphalt Pavement item, and Method B will be utilized when there are less than or equal to 1000 tons per Hot Mix Asphalt Pavement item.”

Revise Subsection “B” by removing it and replacing it with:

“B. Items not designated for Statistical Acceptance will utilize Method B or D Acceptance testing to validate the quality of the material incorporated into the Project. For material paid under Item 403.209 – Method D, or designated to be visually accepted, the Contractor shall provide the Department with a Certification Letter that indicates that the material supplied complies with the Specifications. Test results representative of the certified material shall be attached to the letter.

The Department will randomly sample and test the certified Material for properties noted in Table 1 of Section 502 - Structural Concrete or Table 14 of Section –401.21 Acceptance Method B & D. Material will be subject to rejection as noted in Structural Concrete Section 502.195 - Quality Assurance Method C Concrete or Hot Mix Asphalt, Section 401.2022 Pay Adjustment – Method B & D.”

106.7.1 Standard Deviation Method Revise 106.7.1, subsection H by removing the following from the first paragraph:

“Method B: $PF = [70 + (Quality\ Level * 0.33)] * 0.01$ ”

106.9.1 Warranty by Contractor Revise the third paragraph of this section so that it reads:

“For a related provision regarding obligations regarding plantings, see section 621.36 – Maintenance Period. “

SECTION 107
TIME

107.3.1 General Amend this paragraph by adding “**Juneteenth**” between ‘Patriot’s Day’ and ‘the Friday after Thanksgiving’.

SECTION 108
PAYMENT

108.2.3 Mobilization Payments Replace Standard Specification 108.2.3 – Mobilization Payments with the following:

“108.2.3 Mobilization Payments “Mobilization” includes the mobilization and demobilization of all resources as many times as necessary during the Work.

Percent Mobilization Bid will be determined by taking the amount Bid for Mobilization and dividing by the Total Contract Amount less Mobilization. Mob/(Total Contract – Mob).

Payment will be made at the following intervals:

% Mobilization Bid	% Mobilization Paid at Contract Award	% Mobilization Paid after the Department determines 50% of the work is Complete	% Mobilization Paid at Final Acceptance
10% or less	50%	50%	
More than 10% to 15%	33%	33%	34%
More than 15% to 20%	25%	25%	50%
More than 20% to 30%	15%	15%	70%
Greater than 30%	10%	10%	80%

108.3 Retainage Revise the third paragraph of this section so that it reads:

“Upon Final Acceptance, and determination by the department that there are no claims either by or on the Contractor or Subcontractors; no over payments by the department; no LDs due; and no disincentives due, the Department will reduce Retent to 1% of the original Contract Award amount, or \$100,000, whichever is less, as it deems desirable and prudent.”

108.4.1 Price Adjustment for Hot Mix Asphalt Revise this section by removing it in its entirety and replacing it with the following:

108.4.1 Price Adjustment for Hot Mix Asphalt: For each Contract, a price adjustment for performance graded binder will be made for the following pay items, when the total quantity of Hot Mix Asphalt included in these items is in excess of 500 tons, based on the estimated quantities of these items at the time of bid.

Item 403.102	Hot Mix Asphalt – Special Areas
Item 403.207	Hot Mix Asphalt - 19 mm
Item 403.2071	Hot Mix Asphalt - 19 mm (Polymer Modified)
Item 403.2072	Hot Mix Asphalt - 19 mm (Asphalt Rich Base)
Item 403.208	Hot Mix Asphalt - 12.5 mm
Item 403.2081	Hot Mix Asphalt - 12.5 mm (Polymer Modified)
Item 403.2084	Hot Mix Asphalt - 12.5 mm (Highly Modified HiMAP)
Item 403.209	Hot Mix Asphalt - 9.5 mm (sidewalks, drives, & incidentals)
Item 403.210	Hot Mix Asphalt - 9.5 mm
Item 403.2101	Hot Mix Asphalt - 9.5 mm (Polymer Modified)
Item 403.2104	Hot Mix Asphalt - 9.5 mm (Thin Lift Surface Treatment)
Item 403.21041	Hot Mix Asphalt - 9.5 mm (Polymer Modified Thin Lift Surface Treatment)
Item 403.211	Hot Mix Asphalt – Shim
Item 403.2111	Hot Mix Asphalt – Shim (Polymer Modified)
Item 403.212	Hot Mix Asphalt - 4.75 mm (Shim)
Item 403.213	Hot Mix Asphalt - 12.5 mm (base and intermediate course)
Item 403.2131	Hot Mix Asphalt - 12.5 mm (base and intermediate course Polymer Modified)
Item 403.2132	Hot Mix Asphalt - 12.5 mm (Asphalt Rich Base and intermediate course)
Item 403.301	Hot Mix Asphalt (Asphalt Rubber Gap-Graded)
Item 461.13	Light Capital Pavement
Item 461.210	9.5 mm HMA - Paver Placed Surface
Item 461.2101	Hot Mix Asphalt - 9.5 mm (Polymer Modified)
Item 461.216	Hot Mix Asphalt (Shim)
Item 462.30	Ultra-Thin Bonded Wearing Course
Item 462.301	Polymer Modified Ultra-Thin Bonded Wearing Course

Price adjustments will be based on the variance in costs for the performance graded binder component of hot mix asphalt. They will be determined as follows:

The quantity of hot mix asphalt for each pay item will be multiplied by the performance graded binder percentages given in the table below times the difference in price between the base price and the period price of asphalt cement. Adjustments will be made upward or downward, as prices increase or decrease.

Item 403.102–6.2%
Item 403.207–5.2%
Item 403.2071–5.2%
Item 403.2072–5.8%
Item 403.208–5.6%
Item 403.2081–5.6%
Item 403.2084 – 6.2%
Item 403.209–6.2%
Item 403.210–6.2%
Item 403.2101–6.2%
Item 403.2104–6.2%
Item 403.21041–6.2%
Item 403.211–6.2%
Item 403.2111–6.2%
Item 403.212–6.8%
Item 403.213–5.6%
Item 403.2131–5.6%
Item 403.2132–6.2%
Item 403.301–6.2%
Item 461.13–6.7%
Item 461.210 – 6.4%
Item 461.2101 – 6.4%
Item 461.216 – 6.7%
Item 462.30–0.0021 tons/SY
Item 462.301–0.0021 tons/SY”

SECTION 110 INDEMNIFICATION, BONDING, AND INSURANCE

110.3.2 Commercial General Liability Revise the last sentence in this Section that starts with “The coverage shall also...” and add a sentence to the end so that it reads:

“The coverage shall also include protection against damage claims due to explosives, collapse, and underground coverage. No endorsement excluding damage caused by subsidence, earth movement, and/or earth pressure shall be permitted.”

110.3.9 Administrative & General Provisions Amend this subsection by adding “**Automobile Liability**” under letter A) Additional Insured to the list of exceptions.

10. Assurance Required by 49 CFR: 26.13(a)(b) Revise this section by removing it in its entirety and replacing it with the following:

“a. MaineDOT shall not discriminate on the basis of race, color, national origin, or sex in the award and performance of any DOT-assisted contract or in the administration of its DBE Program or the requirements of 49 CFR part 26. MaineDOT shall take all necessary and reasonable steps under 49 CFR part 26 to ensure nondiscrimination in the award and administration of DOT-assisted contracts. MaineDOT’s DBE Program, as required by 49 CFR part 26 and as approved by DOT, is incorporated by reference in this agreement. The implementation of this program is a legal obligation and failure to carry out its terms shall be treated as a violation of this agreement. Upon notification to the MaineDOT of its failure to carry out its terms shall be treated as a violation of this agreement. Upon notification to the MaineDOT of its failure to carry out its approved program, the Department may impose sanctions as provided for under 49 CFR Part 26, and may, in appropriate cases, refer the matter for enforcement under 18 U.S.C. 1001 and/or the Program Fraud Remedies Act of 1986 (31 U.S.C. 3801 et seq.). This language will appear in financial assistance agreements with sub-recipients.

b. The contractor, sub-recipient, or subcontractor shall not discriminate on the basis of race, color, national origin, or sex in the performance of this contract. The contractor shall carry out applicable requirements of 49 CFR part 26 in the award and administration of DOT assisted contracts. Failure by the contractor to carry out these requirements is a material breach of this contract, which may result in the termination of this contract or such other remedy as the recipient deems appropriate, including, but not limited to:

- 1. Withholding monthly progress payments;**
- 2. Assessing sanctions;**
- 3. Liquidated damages; and/or**
- 4. Disqualifying the contractor from future bidding as non-responsible.”**

SECTION 206 STRUCTURAL EXCAVATION

206.01 Description – *Structural Earth Excavation, Below Grade* delete the entire sentence and replace with **“shall consist of the removal of excavation required for unknown or unanticipated subsurface condition. See 206.04 – Method of Measurement for pay limits.”**

206.04 Method of Measurement – Drainage and Minor Structures Paragraph 1, sentence 2, delete the remainder of the sentence beginning with “...provided the maximum allowable...” And replace with: **“...in accordance with the following limits:”**

- Vertical pay limits:**

- **Below a plane parallel with and 12 inches below the bottom of the drainage or minor structure or**
 - **Below the excavation limits shown in the Bid Documents; whichever is greater.**
- **Horizontal pay limits – The maximum allowable horizontal dimensions shall not exceed those bounded by vertical surfaces 18 inches outside the base, or extreme limits of, the structure, and to the vertical neat lines of underdrain trenches, as shown in the Contract Documents.**

SECTION 401 HOT MIX ASPHALT PAVEMENT

401.19 Contractor Quality Control Amend this Section by adding the following to the end:
“Failure to comply with the approved QCP will result in work suspension and pay reductions as outlined in Section 106.4.6. The Quality Control Plan Value shall be the total bid value for all items covered by the QCP as identified in Special Provision 403.”

SECTION 501 FOUNDATION PILES

501.044 Special Requirements for Steel Pipe Piles and Steel Casings Amend this section by deleting it in its entirety and replacing with:

Pipe piles shall be driven closed ended, unless otherwise specified. When open-ended pipe piles are specified or when the ends are not completely closed ended when driven, the inside of the pile shall be thoroughly cleaned out, and the inside walls cleaned by jetting or other means approved by the Resident. The sediment control required for the cleaning operations shall be covered in the Contractor’s SEWPCP.

Pipe piles shall be inspected and approved by the Resident immediately before concrete is placed in them. They shall be free from rupture and undue deformation and shall be free from water unless the Resident determines that the concrete can be placed without damage to the pile and such that the discharged water will be contained. The Contractor shall provide lights and other equipment necessary to enable the Resident to inspect each pipe pile.

Portland cement concrete for filling the pipe piles shall be placed in one continuous operation to fill the pile completely without causing water contamination. An internal type vibrator shall be used in the top 25 feet. Pile heads shall be protected and cured in accordance with Section 502, Structural Concrete.

The placing of concrete and the driving of piles shall be scheduled so that fresh and setting concrete will not be injured by the pile driving.

Concrete shall not be placed in pipe piles until pile driving has progressed beyond a radius of 15 feet from the pile to be concreted. If pile heave is detected for pipe piles that have been filled with concrete, the piles shall be redriven to the original position after the concrete has attained sufficient strength and a proper hammer-pile cushion system, is in place and is satisfactory to the Resident.

When a reinforcing steel cage is specified, it shall be placed inside the piles to allow for a minimum of 2 inches of concrete cover and the piles shall be filled with concrete to the elevation shown on the Plans.

Full-length pipe piles and steel casings shall be used wherever practicable; however, splicing may be permitted when approved by the Resident. The method of splicing shall be as follows:

- a. Steel pipe piles and steel casings shall be spliced by full penetration butt joint welds.
- b. When the pipe piles and steel casings are to be spliced while in a vertical position, splicing shall be accomplished utilizing single-bevel groove welds with the use of back-up rings. When the pipe piles and steel casings are to be spliced while in a horizontal position, splicing shall be accomplished utilizing single-vee groove welds with the use of back-up rings.
- c. Welded joints shall conform to the Standard Details.

501.047 Splicing Piles Amend this section by deleting it in its entirety and replacing it with:

Full-length piles shall always be used wherever practicable. When full-length piles cannot be used, the number of splices, locations, and details shall be noted in the QCP. Piles fabricated from multiple pieces will be acceptable only if they comply with the following:

H-Beam Piles ^a		Pipe Piles and Steel Casings ^{a,b}	
Lengths	Maximum No. Field Splices	Lengths	Maximum No. Field Splices
Less than 20 ft.	0	Less than 20 ft.	0
Over 20 – 35 ft.	1	Over 20 – 40 ft.	1
Over 35 – 79 ft.	2	Over 40 – 60 ft.	2
Over 79 ft.	1 per 40 ft.	Over 60 – 80 ft.	3
		Over 80 ft.	1 per 20 ft.

^a Pile lengths less than 10 feet will not be spliced, except as the final (top) section of the pile.
^b Where pipe piles are used for pile bent piers, no splices will be allowed in the length of pile from the cutoff elevation to 2 feet below the channel bottom.

When pre-planned splicing is approved, the pile piece of lesser length shall be placed at the tip of the pile (the first part of the pile that enters the ground).

When splicing is allowed, the work shall be done in accordance with the following:

- A. Welding shall be done in accordance with the requirements of the AWS D1.1 welding code.**
- B. Qualify welders in accordance with the most recent edition of the AWS D1.5 code.**
- C. Submit a written Weld Procedure Specification (WPS) for each joint to be included as part of the QCP. The WPSs shall be provided to the Fabrication Engineer for review and approval prior to beginning welding. Provide copies of the approved WPSs to the welder, QC Inspector and Resident prior to beginning welding. Welding performed without an approved WPS and approved QCP will be considered Unacceptable Work.**
- D. Provide a list of qualified welders with copies of their AWS certifications to the Fabrication Engineer for review prior to beginning welding. Welders shall have in their possession, at the time of welding, a valid certification for the process and position to be used in production from the AWS. The welder shall show the Resident their credentials upon request.**
- E. The Contractor shall only use electrodes that are on the Department's Qualified Products List for Welding Electrodes or shall submit alternative electrodes for review and approval by the Fabrication Engineer. Electrodes used shall match those approved for use in the WPS.**
- F. Welding shall not be done: When the temperature in the immediate vicinity of the weld is below 0°F; when the surfaces are damp or exposed to rain, snow, or high wind; or when the welders or welding operators are exposed to inclement conditions.**
- G. The pile shall be preheated to and maintained at 150°F minimum, within 6 inches from the joint during welding.**
- H. Power sources for welders shall have meters indicating amperage/voltage that have been calibrated within 1 year at the time of welding.**
- I. The Contractor shall provide the Department with notice, a minimum of, 7 Days prior to the start of any welding.**
- J. The Contractor shall provide a QC Inspector to perform QC for the welds in accordance with the AWS D1.1 welding code. The QC Inspector shall be an AWS Certified Welding Inspector (CWI) in conformance with the requirements of AWS QC1, Standard for AWS Certifications of Welding Inspectors. The Contractor may submit, in lieu of a CWI, an alternative QC Inspector with documented training and experience in metals fabrication, inspection, and testing for approval by the Fabrication Engineer. The QC Inspector shall be someone other than the welder performing the welds to be inspected.**
- K. The QC Inspector shall inspect all production stages of the welded splice to ensure that workmanship and materials meet the requirements of the AWS D1.1 welding code and the Contract. The QC Inspector shall submit a signed record of all weld inspection documentation to the Resident after welding is completed.**

Record of weld inspection shall include, but not be limited to, the following:

- 1. Name of QC Inspector**
- 2. Project WIN and Location**
- 3. Date**
- 4. Weather conditions**
- 5. Type, size, length, and location of welds.**

6. **Confirmation of appropriate equipment and materials used, including proper handling of welding electrodes.**
7. **Confirmation that welder has approved WPS onsite, and welding is performed in accordance with approved WPS.**
8. **Confirmation that welder is qualified to perform work per approved WPS. Include name and certifications of qualified welder who performed the work.**
9. **Confirm that 100% visual testing, in accordance with AWS D1.1 Table 8.1, has been conducted and any subsequent repairs are made prior to non-destructive testing (NDT).**
10. **Document NDT testing including name of NDT technician, NDT personnel qualifications, type and extent of NDT testing performed, and include NDT testing reports provided by the NDT testing technician.**

L. **Piles shall not be driven until all pile welding has been inspected and accepted by the Department.**

501.0471 Specific Requirements for Splicing H-Beam Piles

- A. Damaged material shall be removed from the end of the driven pile. Lifting holes shall be repaired or trimmed off. The ends of both pieces to be spliced shall be cut off square with the longitudinal axis of the pile and beveled per the approved WPS. All cutting shall be done with the use of a mechanical guide, except that minor trimming may be allowed, as approved by the Resident.
- B. The Contractor shall use an approved mechanical splicer or a full penetration butt weld for the entire cross section of the pile. Mechanical splicers shall be installed per the manufacturer's recommendations, except that the flanges shall be welded using a complete joint penetration weld, per the AWS D1.1 welding code.
- C. In addition to the 100% visual testing (VT) performed by the QC Inspector, the Contractor shall perform NDT on the first two welded splices of the same type/size. The welds shall be radiographically (RT) or ultrasonically (UT) tested for their full length for acceptance per Table 8.2 of AWS D1.1. If both RT/UT-tested splices are determined to be acceptable, no further NDT will be required. If either of the first two RT/UT-tested splices contain defects warranting rejection, RT/UT testing of splices shall continue until two consecutive splices are found to be acceptable.
- D. Should the Department determine that the Quality Control of the Contractor is not producing welds with acceptable quality, then the Department may request the Contractor to perform additional NDT, such as RT or UT of any or all welds. Should the NDT testing identify defects warranting rejection, the welds shall be repaired and retested. The Contractor shall perform the NDT and weld repair work at no additional cost to the Department. If the NDT does not identify defects warranting rejection, then the Department will pay for the cost of the NDT testing. RT and UT defect indications will be evaluated according to the statically loaded criteria of AWS D1.1.

501.0472 Specific Requirements for Splicing Steel Pipe Piles and Steel Casings

- A. Damaged material shall be removed from the end of the driven pile. Lifting holes shall be trimmed off. The ends of both pieces to be spliced shall be cut off square with the

longitudinal axis of the pile and beveled per the approved WPS. All cutting shall be done with the use of a mechanical guide, except that minor trimming may be allowed, as approved by the Resident.

B. Splices shall be welded using an AWS D1.1 Complete Joint Penetration butt weld with a backer ring.

C. In addition to the 100% VT performed by the QC Inspector, the Contractor shall perform NDT on the first two welded splices of the same type/size. The welds shall be RT or UT tested for their full length for acceptance per Table 8.2 of AWS D1.1. If both RT/UT-tested splices are determined to be acceptable, no further NDT will be required. If either of the first two RT/UT-tested splices contain defects warranting rejection, RT/UT testing of splices shall continue until two consecutive splices are found to be acceptable.

D. Should the Department determine that the Quality Control of the Contractor is not producing welds with acceptable quality, then the Department may request the Contractor to perform additional NDT, such as RT or UT of any or all welds. Should the NDT testing identify defects warranting rejection, the welds shall be repaired and retested. The Contractor shall perform the NDT and weld repair work at no additional cost to the Department. If the NDT does not identify defects warranting rejection, then the Department will pay for the cost of the NDT testing. RT and UT defect indications will be evaluated according to the statically loaded criteria of AWS D1.1.

501.048 Prefabricated Pile Tips Amend this section by deleting it in its entirety and replacing it with:

Welding of pile tips shall be done in accordance with the following:

A. Welding shall be done in accordance with the requirements of the AWS D1.1 welding code.

B. Qualify welders in accordance with the most recent edition of the AWS D1.5 code.

C. Submit a written WPS for each tip to be included as part of the QCP. The WPSs shall be provided to the Fabrication Engineer for review and approval prior to beginning welding. Provide copies of the approved the WPS to the welder and Resident prior to beginning welding. Welding performed without an approved WPS and approved QCP will be considered Unacceptable Work.

D. Provide a list of qualified welders with copies of their AWS certifications to the Fabrication Engineer for review prior to beginning welding. Welders shall have in their possession, at the time of welding, a valid certification for the process and position to be used in production from the AWS or other organization acceptable to the Resident. The welder shall show the Resident their credentials upon request.

E. The Contractor shall only use electrodes that are on the Department's Qualified Products List for Welding Electrodes or shall submit alternative electrodes for review and approval by the Fabrication Engineer. Electrodes used shall match those approved for use in the WPS.

F. Pile tips shall be approved by the Resident.

G. Welding shall not be done: When the temperature in the immediate vicinity of the weld is below 0°F; when the surfaces are damp or exposed to rain, snow, or high wind; or when the welders or welding operators are exposed to inclement conditions.

H. The pile shall be preheated to and maintained at 150°F minimum within 6 inches from the joint during welding.

I. Power sources for welders shall have meters indicating amperage/voltage that have been calibrated within 1 year at the time of welding.

J. Pile tips may be welded to the piles by the pile supplier upon approval by the Department. Approval is contingent upon submission of the following: A welding QC Plan; proof that the proposed welder(s) is certified per AWS D1.5; and an AWS D1.1 WPS, with base metal preheated to a minimum of 150°F. The Contractor shall provide notice a minimum of 14 Days prior to the start of any welding by the pile supplier. At a minimum, welds shall be 100% visually inspected by the pile supplier's QC representative.

K. The Contractor shall provide a QC Inspector to perform QC for the welds in accordance with the AWS D1.1 welding code. The QC Inspector shall be an CWI in conformance with the requirements of AWS QC1, Standard for AWS Certifications of Welding Inspectors. The Contractor may submit, in lieu of a CWI, an alternative QC Inspector with documented training and experience in metals fabrication, inspection, and testing for approval by the Fabrication Engineer. The QC Inspector shall be someone other than the welder performing the welds to be inspected.

L. The QC Inspector shall inspect all production stages of the welded splice to ensure that workmanship and materials meet the requirements of the AWS D1.1 welding code and the Contract. The QC Inspector shall submit a signed record of all weld inspection documentation to the Resident after welding is completed.

M.

Record of weld inspection shall include, but not be limited to, the following:

- 1. Name of QC Inspector**
- 2. Project WIN and Location**
- 3. Date**
- 4. Weather conditions**
- 5. Type, size, length, and location of welds.**
- 6. Confirmation of appropriate equipment and materials used, including proper handling of welding electrodes.**
- 7. Confirmation that welder has approved WPS onsite, and welding is performed in accordance with approved WPS.**
- 8. Confirmation that welder is qualified to perform work per approved WPS. Include name and certifications of qualified welder who performed the work.**
- 9. Confirm that 100% VT, in accordance with AWS D1.1 Table 8.1, has been conducted and any subsequent repairs are made prior to NDT.**
- 10. Document NDT testing including name of NDT technician, NDT personnel qualifications, type and extent of NDT testing performed, and include NDT testing reports provided by the NDT testing technician.**

N. The Contractor shall provide notice a minimum of 7 Days prior to the start of any field welding.

- O. Piles shall not be driven until all pile welding has been inspected and accepted by the Department.

501.0481 Specific Requirements for Installing H-Beam Pile Tips

- A. Damaged material shall be removed from the end of the driven pile, as applicable. Lifting holes shall be trimmed off. The end of the pile to which the tip is to be attached shall be cut off square with the longitudinal axis of the pile and prepared per the approved WPS. All cutting shall be done with the use of a mechanical guide, except that minor trimming may be allowed, as approved by the Resident.
- B. Regarding weld size, prefabricated pile tips shall be attached to H-beam piles with 5/16-inch groove welds along each flange, or as recommended by the manufacturer of the pile tips, whichever weld size is larger.
- C. The QC Inspector shall, at a minimum, perform 100% VT on each pile tip weld.
- D. Should the Department determine that the Quality Control of the Contractor is not producing welds with acceptable quality, then the Department may request the Contractor to perform additional NDT, such as RT or UT of any or all welds. Should the NDT testing identify defects warranting rejection, the welds shall be repaired and retested. The Contractor shall perform the NDT and weld repair work at no additional cost to the Department. If the NDT does not identify defects warranting rejection, then the Department will pay for the cost of the NDT testing. RT and UT defect indications will be evaluated according to the statically loaded criteria of AWS D1.1.

501.0482 Specific Requirements for Installing Steel Pipe Pile Tips

- A. Damaged material shall be removed from the end of the driven pile, as applicable. Lifting holes shall be trimmed off. The end of the pile to which the tip is to be attached shall be cut off square with the longitudinal axis of the pile and prepared per the approved WPS. All cutting shall be done with the use of a mechanical guide, except that minor trimming may be allowed, as approved by the Resident.
- B. Unless otherwise shown on the Plans, steel pipe piles shall have pointed cast steel pile tips.
- C. Regarding weld size, prefabricated pile tips shall be attached to steel pipe piles with a continuous 5/16-inch groove weld along the full perimeter of the pile, or as recommended by the manufacturer of the pile tips, whichever weld size is larger.
- D. The QC Inspector shall, at a minimum, perform 100% VT on each pile tip weld.
- E. Should the Department determine that the Quality Control of the Contractor is not producing welds with acceptable quality, then the Department may request the Contractor to perform additional NDT, such as RT or UT of any or all welds. Should the NDT testing identify defects warranting rejection, the welds shall be repaired and retested. The Contractor shall perform the NDT and weld repair work at no additional cost to the Department. If the NDT does not identify defects warranting rejection, then the Department will pay for the cost of the NDT testing. RT and UT defect indications will be evaluated according to the statically loaded criteria of AWS D1.1.

501.05 Method of Measurement

c. Piles in Place Revise the third paragraph by replacing the “10” with “20” so that it reads:

Unused pile cutoffs **20** feet or more in length, except those required to accommodate the Contractor’s construction method, as discussed herein, will remain the property of the Department and will be stored at a bridge maintenance yard nearest the project. Hauling and unloading of piles will be done by the Contractor or by the Department, depending upon availability of services.

SECTION 502
STRUCTURAL CONCRETE

502.03 Materials Amend this section by adding the following to the list of materials:

Combined Aggregate Grading for Concrete 703.03

502.07 Mixing and Delivery Remove the last sentence in Paragraph A that starts with “With prior approval... and replace with the following:

“An approved hydration stabilizing admixture may be used to increase the discharge time. Justification for the need for a hydration stabilizing admixture shall be provided in the QC Plan. When a hydration stabilizing admixture is used, the manufacturer, dosage rate and discharge time, from the time cement is added to the aggregate, shall be documented in the approved QC Plan. The proposed discharge time(s) shall be based on the manufacturer’s written recommendations, the anticipated concrete temperatures and anticipated ambient conditions at the time of placement(s). Discharge time(s) shall be adjusted when conditions change or are not as anticipated as outlined in the approved QC Plan. The discharge time(s) approved by the Department shall be subject to change at any time, and discharge of concrete into the permanent work shall cease immediately if the concrete is determined to have attained Accelerated Hydration Gain. Accelerated Hydration Gain being the condition where the fresh concrete has hydrated to the point where the workability and finishability is detrimental to the quality of the final product. Determination of when concrete has attained Accelerated Hydration Gain shall be made by the Contractor’s Quality Control Technician(s) and shall be based on parameters proposed by the Contractor in the QC Plan, such as, but not limited to, loss of slump, plasticity, or workability, an increase in concrete temperature, or a change in the percentage of entrained air.”

502.09 Forms and Falsework Amend this subsection by adding the subsection title “**502.10 Placing Concrete**” after section “D” Removal of Forms and False work” and after the paragraph beginning with “2. Forms and False work, including blocking...”. So that a new subsection starts and reads:

“502.10 Placing Concrete

A. **General Concrete shall not be placed until forms”**

502.1701 Quality Control, Method A and B Revise this Section so that the first paragraph and the first sentence of the second paragraph read:

502.17 Quality Control The Contractor shall control the quality of the concrete through testing, inspection, and practices which shall be described in the QCP, sufficient to assure a product meeting the Contract requirements. The QCP shall meet the requirements of Section 106, Quality, and this specification. No work under this item shall proceed until the QCP is submitted to and approved by the Department. Failure to comply with the approved QCP will result in work suspension and pay reductions as outlined in Section 106.4.6. The Quality Control Plan Value shall be the total bid value for all cast-in-place items covered by the QCP, using the P value listed in Special Provision 502. If no P value is listed, a value of \$350, or bid value per cubic yard, whichever is less, shall be used.

502.1701 Quality Control, Method A and B The QCP shall address all elements that affect the quality of the structural concrete including, but not limited to, the following: “

Under the list with the heading, “The QCP shall address all elements that affect the quality of the structural concrete including, but not limited to, the following:”:

Replace “F” to read: “**Mix and Transportation, including Time from Batching to Completion of Delivery, as well as manufacturer, product name, proposed dosage(s) and discharge time(s) if a hydration stabilizing admixture is used.**”

Replace “H” to read: “**Process QC Testing, including monitoring for attainment of Accelerated Hydration Gain when a hydration stabilizing admixture is used.**”

Revise this section by replacing the paragraph before Table 4 that starts out “The Contractor shall maintain...” to read:

“The Contractor shall maintain records of all QC tests and calculations. All QC test data shall be signed by the person who performed the test. The representative gradation test results shall be reported to the Department before the placement they represent. This initial representative gradation test shall be sampled a maximum of 30 days prior to the production day. The Contractor or supplier shall retain split samples of the most recent QC gradations for possible testing by the Department. In addition, the Department will sample the aggregates at the plant monthly to determine compliance with 703.03 Combined Aggregate Grading for Concrete. The Combined Aggregate Grading will be calculated by mathematically blending the individual aggregate gradations using the batch percentages from the approved mix design. If the Department’s gradation tests determine that the aggregate does not meet the specified gradation limits, the current procedure mentioned in MaineDOT PCC Policies and Procedures Manual shall be followed. The compressive strength test results shall be reported to the Department by 10:00 A.M. of the first working day following the test. The Contractor shall record all onsite QC test data and calculations at the time of the placement and present this information, on a form acceptable to the Department, to the Department by 10:00 A.M. of the first working day following the concrete placement. Batch tickets shall be representative of that day’s total moisture in aggregate value, QC test data for total moisture in aggregate shall be provided to the

Department by 10:00 A.M. of the first working day following the concrete placement. All Method A and B QC testing shall meet the minimum requirements found in Table 4.”

Section 502.1701, Quality Control, Revise Table 4 of this Subsection by removing it in its entirety and replacing it with:

**TABLE 4
METHOD A & B MINIMUM QUALITY CONTROL TESTING REQUIREMENTS***

TEST	TEST METHOD	SAMPLING LOCATION	FREQUENCY
Gradation	AASHTO T 27 & T 11	Stockpile	One representative set per proposed grading before production One set every 100 yd ³ (Min. 1 set per month)
Organic Impurities	AASHTO T 21	Stockpile	Once per fine aggregate per year**
% Absorption	AASHTO T 84 & T 85	Stockpile	Once per aggregate per year
Specific Gravity	AASHTO T 84 & T 85	Stockpile	Once per aggregate per year
Total Moisture in Aggregate	AASHTO T 255	Stockpile	One set per day's production
Free Water and Aggregate Wt.	N/A		One per day's production
% Entrained Air	AASHTO T 152	On Project	On first two loads and every third load thereafter provided consistent results are achieved
Compressive Strength	AASHTO T 22	On Project	One set per subplot
Compressive Strength	AASHTO T 22	On Project	One set per subplot

*Additional QC testing will be required any time a process change occurs during a placement, including changes in type or dosage of admixture. Additional testing shall include, but is not limited to, entrained air testing.

**If the color produced is a laboratory designation Plate III, then the fine aggregate shall be tested once per month

502.1702 Quality Control, Method C Remove this sub section and replace it with:

“The Contractor shall submit a QCP listing the mix design(s) to be used, the name and location of the production facility, a brief description of the placement and curing process and the name and qualifications of any QCT to be used. When a hydration stabilizing admixture is proposed for use, the manufacturer, product name, dosage rate and discharge time, from the time cement is added to the aggregate, shall be included, as well as procedures for monitoring attainment of Accelerated Hydration Gain. A QCT will be required. The Contractor shall provide a Certificate of Compliance for each truckload of concrete to the Department at the time of the load placement.”

502.18, Method of Measurement, Revise Subsection ‘F’ by removing the word ‘transverse’ so that it reads: **“Saw cut grooving of concrete wearing surfaces, complete and accepted, will be measured for payment as one lump sum.”**

502.19, Basis of Payment, Revise the third paragraph by removing the word ‘transverse’ so that it reads: **“Saw cut grooving of concrete wearing surfaces will be paid for at the Contract Lump Sum Price, which shall be payment for furnishing all materials, labor, and equipment, including depth gauges and all incidentals, to satisfactorily complete the work.”**
(Also see 535.24 and 535.25 for related changes)

SECTION 503 REINFORCING STEEL

Section 503.07 Splicing Revise this section by removing the table and following footnote and replacing them with:

Minimum Lap Splice Length (inches)									
Bar Type	Bar Size								
	#3	#4	#5	#6	#7	#8	#9	#10	#11
Plain or Galvanized	16	20	24	29	38	47	59	72	85
Epoxy or Dual Coated	17	24	36	43	56	71	88	107	128
Stainless	19	24	30	36	47	59	73	89	107
Low-carbon Chromium	24	32	39	47	63	78	97	119	142

“The minimum lap splice lengths in the table above are based on the parameters below. When any of these parameters are altered, appropriate minimum lap splice lengths will be as shown on the Plans.

- Normal weight concrete
- Minimum 28-day concrete compressive strength from 4,000 psi to 10,000 psi

- **Class B tension lap splice**
- **Minimum center-to-center spacing between bars of 6 inches**
- **Minimum clear cover of 2 inches**
- **Nominal reinforcing steel yield strengths**
 - **Low-carbon Chromium = 100 ksi**
 - **Stainless = 75 ksi**
 - **All others = 60 ksi**
- **Reinforcement with yield strengths greater than 75 ksi shall have beam transverse reinforcement and column ties provided over the required lap splice length in accordance with the current edition of the AASHTO LRFD Bridge Design Specifications**

When lap splices are placed horizontally in an element where the concrete depth below the splice will be 12 inches, or more, the indicated lap splice lengths shall be multiplied by a factor of 1.3.”

Amend the Paragraph starting with **Welded Splices may be made...**” by adding to the last sentence beginning so that it reads **“The Contractor shall submit complete details of their proposed method of making welded splices for the Resident's approval at least 10 days prior to use.”**

504.12 Protective Coatings Revise this subsection by removing the paragraph beginning with “When galvanizing is specified” and replacing it with:

“When galvanizing is specified, clean the steel in accordance with SSPC-SP 6 prior to galvanizing. Galvanize in accordance with AASHTO M 111 (ASTM A123). Galvanize fasteners in accordance with AASHTO M 232 (ASTM A153), ASTM F2329, or ASTM B695, Class 50, Type I. Galvanized nuts shall be lubricated with a water-soluble lubricant containing a dye that contrasts with the color of the galvanizing.”

SECTION 506 SHOP APPLIED PROTECTIVE COATING – STEEL

506.10 Description Revise this subsection by removing the entire paragraph in its entirety and replacing it with:

“This work shall consist of surface preparation and application of coating systems in accordance with the Plans and this Specification. The color of structural steel painted in its entirety shall comply with SAE AMS-STD-595 – Colors Used in Government Procurement Color No. 14272 (Green), unless otherwise specified in the Contract. The color of partially painted weathering steel shall comply with SAE AMS-STD-595 – Colors Used in Government Procurement Color No. 30045 (Brown), unless otherwise specified in the Contract. All other coating colors shall be as specified in the Contract.”

506.13 Surface Preparation Amend this section by adding this paragraph to the end:

“Steel shall meet the requirements of SSPC SP8 Pickling prior to being immersed in the zinc tanks. Verification of the surface preparation shall be included in the QC documentation.”

SECTION 518 STRUCTURAL CONCRETE REPAIR

518.02 Repair Materials Replace the paragraph beginning with “Where the depth of placement...” with the following:

“Where the depth of placement is equal to or greater than 1 inch, the Contractor may use concrete as the repair material. When concrete is used, the coarse aggregate shall conform to the requirements of the table below and Standard Specification Section 703.02, Coarse Aggregate for Concrete, or 703.03, Combined Aggregate Grading for Concrete.”

Remove the second table with the heading, “Sieve Designation Percent by Weight Passing a Square Mesh Sieve”

SECTION 523 BEARINGS

523.051 Protective Coating Revise this subsection by removing the paragraph beginning with “Anchor rods shall be galvanized...” and replacing with:

“Anchor rods shall be galvanized. When anchor rods are designated to secure bare unpainted steel or painted steel, a dielectric coating (epoxy or bituminous type coatings are acceptable) shall be applied to the anchor rod and/or adjacent steel to prevent contact between galvanized surfaces and painted or unpainted steel.”

523.22 Fabrication Amend this subsection by adding the following: **“Elastomeric Bearings shall be fabricated in accordance with AASHTO M251.”**

SECTION 526 CONCRETE BARRIER

Amend this section by deleting it in its entirety and replacing it with:

“526.01 Description This work shall consist of the furnishing, constructing, erecting, setting, resetting, and removal of concrete barrier and associated elements in accordance with these specifications, the Standard Details, and the lines and grades shown on the Plans or established by the Resident.

The types of concrete barrier are designated as follows:

Portable Concrete Barrier Type I Double faced removable barrier in accordance with the Standard Details.

Permanent Concrete Barrier Type II Double faced barrier as shown on the Plans.

Permanent Concrete Barrier Type IIIa Single faced barrier 32 inches high in accordance with the Standard Details or as shown on the Plans.

Permanent Concrete Barrier Type IIIb Single faced barrier 42 inches high in accordance with the Standard Details or as shown on the Plans.

Permanent Concrete Transition Barrier Barrier of various heights joining steel bridge rail to steel guardrail in accordance with the Standard Details or as shown on the Plans.

Permanent Texas Classic Rail Barrier Traffic rail or sidewalk rail, in accordance with the Standard Details or as shown on the Plans.

526.02 Materials

a. **Concrete** Concrete for barriers, both permanent and portable, shall have a design strength of 5,000 psi.

For cast-in-place barrier: The concrete shall be Class LP, in accordance with Standard Specification Section 502, Structural Concrete.

For precast barrier: The concrete shall meet the requirements of Standard Specification 712.061, Structural Precast Concrete Units, except that the stripping strength for precast barriers is 4,000 psi.

b. **Reinforcing Steel** Reinforcing steel shall meet the requirements of Section 503, Reinforcing Steel.

c. **Structural Steel** Plates and barrier connections shall meet the requirements specified in Standard Specification 504 - Structural Steel and shall be hot dip galvanized after fabrication in accordance with Standard Specification 506, Shop Applied Protective Coating – Steel

d. **Bolts** Bolts shall meet the requirements specified in Section 713.02, High Strength Bolts.

e. **Connecting Pins for Portable Concrete Barrier** Portable concrete barriers must be connected using a 1- inch diameter pin. The connecting pin must be smooth, not deformed, i.e., reinforcing bar may not be used, and shall meet the strength requirements of ASTM A449 steel. Materials with greater strength may be used with the approval of the Department.

f. Anchor Pins for Portable Concrete Barrier Anchoring to concrete or asphalt will be required when specified on the Plans. When required, portable concrete barriers must be anchored using a 1 ½ - inch diameter anchor pin. The anchor pin must be smooth, not deformed, i.e., reinforcing bar may not be used, and shall meet the strength requirements of ASTM A36 steel. Materials with greater strength may be used with the approval of the Department.

g. Device Crashworthiness MaineDOT is transitioning to MASH2016 criteria for Portable Concrete Barrier on the following schedule:

New Portable Concrete Barrier shall be crash tested and/or evaluated to MASH2016 criteria.

Current Portable Concrete Barrier in useful serviceable condition that is successfully tested to NCHRP Report 350 or MASH2009 criteria may be utilized through December 31, 2029.

Other current Portable Concrete Barrier that is deemed acceptable by the Department may be utilized on projects off the National Highway System through December 31, 2024.

526.03 Construction Requirements

Cast-in-place barriers shall be fabricated in accordance with Standard Specification Section 502, Structural Concrete. Precast barriers shall be fabricated in accordance with Standard Specification 534, Precast Structural Concrete.

Concrete finish for permanent barrier shall be rubbed as defined in Standard Specification Section 502, Structural Concrete, 502.13 D2 or an approved equal.

Portable concrete barrier shall be generally free from fins and porous areas and shall present a neat and uniform appearance.

Permanent barrier shall have a protective coating applied in accordance with Standard Specification Section 515, Protective Coating for Concrete Surfaces.

Reflective delineators for concrete median barrier shall meet the requirements of Special Provision 645, Highway Signing.

Prefomed Joint Filler shall meet the requirements specified in Subsection 705.01, Prefomed Expansion Joint Filler.

Permissible dimensional tolerances for all concrete barriers shall be as follows:

a. Cross-sectional dimensions shall not vary from design dimensions by more than ¼ inch. The vertical centerline shall not be out of plumb by more than ¼ inch.

b. Longitudinal dimensions shall not vary from the design dimensions by more than $\frac{1}{4}$ inch per 10 feet of barrier section and shall not exceed $\frac{3}{4}$ inches per section.

c. Location of anchoring holes shall not vary by more than $\frac{1}{2}$ inch from the dimensions shown in the concrete barrier details on the Plans.

d. Surface straightness shall not vary more than $\frac{1}{4}$ inch under a 10-foot straightedge.

e. The barrier shall have no significant cracking. Significant cracking is defined as fractures or cracks passing through the section, or any continuous crack extending for a length of 12 inches or more, regardless of position in the section.

526.04 Method of Measurement Permanent Concrete Barrier Type II, IIIa, IIIb, Texas Classic Rail, and Precast Median Barrier will be measured for payment by lump sum, complete in place.

Portable concrete barrier, both anchored and unanchored will be measured for payment by lump sum. Lump sum measurement will include verification of the installation and removal of all portable concrete at the completion of the Contractor's operations.

The Contractor shall replace sections of portable concrete barrier, including anchored barrier damaged by the traveling public when directed by the Resident. Replacement sections will be measured for payment in accordance with Standard Specification 109.7, Equitable Adjustments to Compensation and Time.

Transition barrier will be measured by each, complete in place.

526.05 Basis of Payment The accepted quantities of Concrete Barrier Type II, IIIa, IIIb, Texas Classic Rail, and Precast Median Barrier will be paid for at the Contract lump sum price for the type specified, complete in place.

The accepted quantities of Portable Concrete Barrier Type I, both anchored and unanchored will be paid for at the Contract lump sum price. Such payment shall be full compensation for furnishing all materials, assembling, moving, resetting, transporting, temporarily storing, removing barrier, furnishing new parts as necessary, and all incidentals necessary to complete the work.

Portable barrier shall become the property of the Contractor upon completion of the use of the barrier on the project and shall be removed from the project site by the Contractor.

Transition barrier will be paid for at the Contract price each, complete in place.

The accepted quantity of all types of concrete barrier, whether portable or permanent, will be paid for at the lump sum or per each price, as applicable, which payment shall be full compensation for all materials, including reinforcing steel, protective coating, reflective

delineators, steel plates and hardware, equipment, labor and incidentals required, as necessary, to complete the work.

Payment will be made under:

	<u>Pay Item</u>	<u>Pay Unit</u>
526.301	Portable Concrete Barrier, Type I	Lump Sum
526.304	Portable Concrete Barrier, Anchored Type I	Lump Sum
526.312	Permanent Concrete Barrier Type II	Lump Sum
526.321	Permanent Concrete Barrier Type IIIa	Lump Sum
526.323	Texas Classic Rail	Lump Sum
526.331	Permanent Concrete Barrier Type IIIb	Lump Sum
526.34	Permanent Concrete Transition Barrier	Each
526.502	Precast Concrete Median Barrier	Lump Sum”

SECTION 527 ENERGY ABSORBING UNIT

527.02 Materials Amend this section by deleting it in its entirety and replacing it with:

“MaineDOT is transitioning to MASH2016 criteria for Work Zone Traffic Control Devices on the following schedule:

Portable Crash Cushions will be crash tested and/or evaluated to MASH2016 criteria by January 1, 2030. Current Category 3 devices in useful serviceable condition that are successfully tested to NCHRP Report 350 or MASH2009 criteria may be utilized through December 31, 2029.

Work Zone Crash Cushions shall be selected from the Department’s Qualified Products List of Crash Cushions/Impact Attenuators or approved equal.”

SECTION 535 PRECAST, PRESTRESSED CONCRETE SUPERSTRUCTURE

535.02 Materials Replace the description of “Coarse Aggregate for Concrete (Class A, AA, or Latex) in its entirety with: **“Coarse Aggregate for Concrete (Class A, AA, or SP-1-7)”**

535.22 Tolerances Amend this section by deleting it in its entirety and replacing it with:

“Product dimensional tolerances shall be in conformance with the latest edition of PCI MNL-135, Tolerance Manual for Precast and Prestressed Concrete Construction, as applicable to the particular product (e.g., slab, I-girder, box beam), the Plans, and this Specification. Use Box

Beam fabrication tolerances for voided or solid slab beams and use Double Tee tolerances for NEXT beams. In case of dispute, the Fabrication Engineer shall determine the allowable tolerance.”

535.24 Installation of Slabs, Beams, and Girders Revise the 5th paragraph by replacing “6.0 and 9.0” to “5.0 and 8.0” so it reads: **“Ready mixed grout shall achieve a design compressive strength of 6,000 psi at 28 days, have an entrained air content of between 5.0 and 8.0 percent, be non-shrink, flowable, and contain a non-shrink additive listed on the Department QPL for expansive cements.”**

535.25, Installation of Precast/Prestressed Deck Panels Revise the 2nd paragraph by replacing “6.0 and 9.0” to “5.0 and 8.0” so it reads: **“Ready mixed grout shall achieve a design compressive strength of 6,000 psi at 28 days, have an entrained air content of between 5.0 and 8.0 percent, be non-shrink, flowable, and contain a non-shrink additive listed on the Department QPL for expansive cements.”**

SECTION 606 GUARDRAIL

Amend this section by replacing it with the following:

606.01 Description This work shall consist of furnishing and installing guardrail components in accordance with these specifications and in reasonably close conformity with the lines and grades shown on the plans or as established. Guardrail is designated as:

31” W-Beam Guardrail - Mid-Way Splice

Galvanized steel w-beam, 8” wood or composite offset blocks, galvanized steel posts

Thrie Beam

Galvanized steel thrie beam, 8” wood or composite offset blocks, galvanized steel posts

Median guardrail shall consist of two beams of the above types, mounted on single posts.

Bridge mounted guardrail shall consist of furnishing all labor, materials, and equipment necessary to install guardrail as shown on the plans. This work shall also include drilling for and installation of offset blocks if specified, and incidental hardware necessary for satisfactory completion of the work.

Remove and Reset and Remove, Modify, and Reset guardrail shall consist of removing the existing designated guardrail and resetting in a new location as shown on the plans or directed by the Resident. Remove, Modify, and Reset guardrail and Modify guardrail include the following guardrail modifications: Removing plate washers at all posts, except at anchorage assemblies as noted on the Standard Details, adding offset blocks, and other modifications as listed in the Construction Notes or General Notes. Modifications shall conform to the guardrail Standard Details.

Bridge Connection shall consist of the installation and attachment of beam guardrail to the existing bridge. This work shall consist of constructing a concrete end post or modifying an existing end post as required, furnishing, and installing a terminal connector, necessary hardware, and incidentals required to complete the work as shown on the plans. Bridge Transition shall consist of a bridge connection and furnishing and installing guardrail components as shown in the Standard Details.

606.02 Materials Materials shall meet the requirements specified in the following Sections of Division 700 - Materials:

Timber Preservative	708.05
Metal Beam Rail	710.04
Guardrail Posts	710.07
Guardrail Hardware	710.08

Guardrail components shall meet the applicable standards of "A Guide to Standardized Highway Barrier Hardware" prepared and approved by the AASHTO-AGC-ARTBA Joint Cooperative Committee, Task Force 13 Report.

Posts for underdrain delineators shall be "U" channel steel, 8 ft long, 2 ½ lb/ft minimum and have 3/8-inch round holes, 1-inch center to center for a minimum distance of 2 ft from the top of the post.

Reflectorized Flexible Guardrail Markers shall be mounted on all guardrails. A marker shall be mounted onto guardrail posts at the flared guardrail terminal end point and tangent point, both at the leading and trailing ends of each run of guardrail. The marker's flexible posts shall be gray with either silver-white or yellow reflectors (to match the edge line striping) at the tangents, red at leading ends, and green at trailing ends. Whenever the guardrail terminal is not flared, markers will only be required at the terminal end point. These shall be red or green as appropriate. Markers shall be installed on the protected side of guardrail posts unless otherwise approved by the Resident. Reflectorized flexible guardrail markers shall be from the Department's Qualified Products List of Delineators. The marker shall be gray, flexible, durable, and of a non-discoloring material to which 3-inch by 9-inch reflectors shall be applied, and capable of recovering from repeated impacts and meeting MASH 16 requirements. Reflective material shall meet the requirements of Section 719.01 for ASTM D 4956 Type III reflective sheeting. The marker shall be secured to the guardrail post with two fasteners, as shown in the Standard Details.

Reflectorized beam guardrail reflectors shall be mounted on all "w" beam guardrail and shall be either the "butterfly" type or linear delineation system panels. "Butterfly" or linear delineation panels shall be installed at approximately 62.5 foot intervals on tangents (after every tenth post) and 31.25 feet on curves (after every fifth post), and shall be centered on the guardrail beam. On Divided highways, the left-hand delineators shall be yellow and the right-hand delineators shall be silver/ white. On two-way directional highways, the right-hand side will have silver / white reflectors and no reflectorized delineator used on the left. Delineators shall have reflective sheeting that meets or exceeds the requirements of Section 719.01.

“Butterfly” reflectors shall be fabricated from high-impact, ultraviolet & weather resistant thermoplastic. Aluminum, galvanized metal or other materials shall not be used. Reflective sheeting will be applied to only one side of the delineator facing the direction of traffic and shall be centered vertically on the guardrail beam as shown in the Standard Detail 606(7).

Linear delineation system panels shall be 1.5 inches wide by approximately 11 inches nominal length, with a minimum of 5 raised lateral ridges spaced at approximately 2.25 inches. The height of each ridge shall be 0.34 inches with a 45 degree profile and a 0.28 inches radius at the top. Sheeting shall be laminated to thin gauge aluminum with a pre-applied adhesive tape on the back. Panels shall not be installed over seams or bolt heads and shall be centered horizontally on the guardrail beam; linear delineation panels shall be attached to only one guardrail beam. The guardrail beam surface shall be cleaned and prepared according to the manufacturer’s instructions. Air temperature and guardrail surface temperature must be a minimum of 50 degrees F (10 C) with rising temperature at the time of installation.

Exact locations of the either the “butterfly” type or the linear delineation panels shall be approved by the Resident prior to installation.

Single wood post shall be of cedar, white oak, or tamarack, well-seasoned, straight, and sound and have been cut from live trees. The outer and inner bark shall be removed, and all knots trimmed flush with the surface of the post. Posts shall be uniform taper and free of kinks and bends.

Single steel post shall conform to the requirements of Section 710.07 b.

Single steel pipe post shall be galvanized, seamless steel pipe conforming to the requirements of ASTM A120, Schedule No. 40, Standard Weight.

Acceptable multiple mailbox assemblies shall be listed on the Department’s Qualified Products List and shall be MASH 16 tested and approved.

Flared and Tangent w-beam guardrail terminals and guardrail offset blocks shall be from the Department’s Qualified Products List. Flared terminals shall be installed with a 4 ft offset as shown in the Manufacturer’s installation instructions.

Anchorage assemblies used to anchor trailing ends, radius guardrail, or other ends not exposed to traffic shall meet the applicable standards of "A Guide to Standardized Highway Barrier Hardware" prepared and approved by the AASHTO-AGC-ARTBA Joint Cooperative Committee, Task Force 13 Report, Drawing SEW02a.

Existing materials damaged or lost during adjusting, removing and resetting, or removing, modifying, and resetting, shall be replaced by the Contractor without additional compensation. Existing guardrail posts and guardrail beams found to be unfit for reuse shall be replaced when directed by the Resident.

606.03 Posts Posts for guardrail shall be set plumb in holes or they may be driven if suitable driving equipment is used to prevent battering and distorting the post. When posts are driven

through pavement, the damaged area around the post shall be repaired with approved bituminous patching. Damage to lighting and signal conduit and conductors shall be repaired by the Contractor.

When set in holes, posts shall be on a stable foundation and the space around the posts, backfilled in layers with suitable material, thoroughly tamped.

The reflectorized flexible guardrail markers shall be set plumb with the reflective surface facing the oncoming traffic. Markers shall be installed on the protected side of guardrail posts. Markers, which become bent or otherwise damaged, shall be removed and replaced with new markers.

Single wood posts shall be set plumb in holes and backfilled in layers with suitable material, thoroughly tamped. The Resident will designate the elevation and shape of the top. The posts, that are not pressure treated, shall be painted two coats of good quality oil base exterior house paint.

Single steel posts shall be set plumb in holes as specified for single wood posts or they may be driven if suitable driving equipment is used to prevent battering and distorting the post.

Additional bolt holes required in existing posts shall be drilled or punched, but the size of the holes shall not exceed the dimensions given in the Standard Details. Metal around the holes shall be thoroughly cleaned and painted with two coats of approved aluminum rust resistant paint. Holes shall not be burned.

606.04 Rails Brackets and fittings shall be placed and fastened as shown on the plans. Rail beams shall be erected and aligned to provide a smooth, continuous barrier. Beams shall be lapped with the exposed end away from approaching traffic.

End assemblies shall be installed as shown on the plans and shall be securely attached to the rail section and end post.

All bolts shall be of sufficient length to extend beyond the nuts but not more than ½ inch. Nuts shall be drawn tight.

Additional bolt holes required in existing beams shall be drilled or punched, but the size of the holes shall not exceed the dimensions given in the Standard Details. Metal around the holes shall be thoroughly cleaned and painted with two coats of approved aluminum rust resistant paint. Holes shall not be burned.

606.045 Offset Blocks The same offset block material is to be provided for the entire project unless otherwise specified.

606.05 Shoulder Widening At designated locations the existing shoulder of the roadway shall be widened as shown on the plans. All grading, paving, seeding, and other necessary work shall be in accordance with the Specifications for the type work being done.

606.06 Mail Box Post Single wood post shall be installed at the designated location for the support of the mailbox. The multiple mailbox assemblies shall be installed at the designated location in

accordance with the Standard Details and as recommended by the Manufacturer. Attachment of the mailbox to the post will be the responsibility of the home or business owner.

606.07 Abraded Surfaces All galvanized surfaces of new guardrail and posts, which have been abraded so that the base metal is exposed, and the threaded portions of all fittings and fasteners and cut ends of bolts shall be cleaned and painted with two coats of approved rust resistant paint.

606.08 Method of Measurement Guardrail will be measured by the linear foot from center to center of end posts along the gradient of the rail except where end connections are made to masonry or steel structures, in which case measurement will be as shown on the plans. When connected to radius rail, measurement will be to the end of the last tangent beam.

Guardrail terminal, reflectorized flexible guardrail marker, terminal end, anchorage assembly, bridge transition, bridge connection, multiple mailbox post, and single post will be measured by each unit of the kind specified and installed.

Widened shoulder will be measured as a unit of grading within the limits shown on the plans.

Excavation in solid rock for placement of posts will be paid under force account unless otherwise indicated in the Bid Documents.

Reflectorized beam guardrail reflectors (“butterfly” type or linear delineation system panels) when identified by pay item, will be measured for payment by each.

606.09 Basis of Payment The accepted quantities of guardrail will be paid for at the contract unit price per linear foot for the type specified, complete in place. Reflectorized beam guardrail (“butterfly”-type) delineators will not be paid for directly but will be considered incidental to guardrail items. Reflectorized flexible guardrail marker, terminal end, anchorage assembly, bridge transition, bridge connection, multiple mailbox post, and single post will be paid for at the contract unit price each for the kind specified complete in place.

Guardrail terminals will be paid for at the contract price each, complete in place which price shall be full payment for furnishing and installing all components including the terminal section, posts, offset blocks, "w" beam, cable foundation posts, plates and for all incidentals necessary to complete the installation within the limits as shown on the Standard Details or the Manufacturer’s installation instructions. Pay limits for a flared terminal will be 37.5 feet. Pay limits for a tangent terminal will be 50 feet. Each guardrail terminal will be clearly marked with the Manufacturer’s name and model number to facilitate any future needed repair. Such payment shall also be full compensation for furnishing all material, excavating, backfilling holes, assembling, and all incidentals necessary to complete the work, except that for excavation for posts or anchorages in solid ledge rock, payment will be made under 109.7.5 – Force Account. Type III Retroreflective Adhesive Sheeting shall be applied to the approach buffer end sections and sized to substantially cover the end section. On all roadways, the ends shall be marked with alternating black and retroreflective yellow stripes. The stripes shall be 3 in wide and sloped down at an angle of 45 degrees toward the side on which traffic is to pass the end section. Guardrail terminals shall also include a set of installation drawings supplied to the Resident.

Anchorage to bridge end posts will be part of the bridge work. Connections thereto will be considered included in the unit bid price for guardrail.

Guardrail to be placed on a radius of curvature of 150 ft or less will be paid for under the designated radius pay item for the type guardrail being placed.

Widened shoulder will be paid for at the contract unit price each complete in place and will be full compensation for furnishing and placing, grading and compaction of aggregate subbase and any required fill material.

Adjust guardrail will be paid for at the contract unit price per linear foot and will be full compensation for adjusting to grade. Payment shall also include adjusting guardrail terminals where required.

Modify guardrail will be paid for at the contract unit price per linear foot and will be full compensation for furnishing and installing offset blocks, additional posts, and other specified modifications; removing, modifying, installing, and adjusting to grade existing posts and beams; removing plate washers and backup plates, and all incidentals necessary to complete the work. Payment shall also include removing and resetting guardrail terminals where required.

Remove and Reset guardrail will be paid for at the contract unit price per linear foot and will be full compensation for removing, transporting, storing, reassembling all parts, necessary cutting, furnishing new parts when necessary, reinstalling at the new location, and all other incidentals necessary to complete the work. Payment shall also include removing and resetting guardrail terminals when required.

Remove, Modify, and Reset guardrail will be paid for at the contract unit price per foot and will be full compensation for the requirements listed in Modify guardrail and Remove and Reset guardrail.

Bridge Connections will be paid for at the contract unit price each. Payment shall include, attaching the connection to the endpost including furnishing and placing concrete and reinforcing steel necessary to construct new endposts if required, furnishing and installing the terminal connector, and all miscellaneous hardware, labor, equipment, and incidentals necessary to complete the work.

Bridge Transitions will be paid for at the contract unit price each. Payment shall include furnishing and installing the three beam or "w"-beam terminal connector, doubled beam section, and transition section, where called for, posts, hardware, precast concrete transition and vertical curb, and any other necessary materials and labor, including the bridge connection as stated in the previous paragraph.

No payment will be made for guardrail removed, but not reset and all costs for such removal shall be considered incidental to the various contract pay items.

Reflectorized beam guardrail reflectors ("butterfly" type and the linear delineation panels) will not be paid for directly but will be considered incidental to all new guardrail items. The Contractor shall

furnish and install either the “butterfly” type or linear delineation panels, at its discretion, for new guardrail items.

Reflectorized beam guardrail reflectors (either “butterfly” type or linear delineation system panels) will be paid for under the applicable pay items for installation in conjunction with Adjust, Modify, Remove and Reset, Remove Modify and Reset guardrail items. The accepted quantity of “butterfly” type or linear delineation system panels will be paid for at the contract unit price each for all work and materials furnished to install, complete in place, including all incidentals necessary to complete the work.

Payment will be made under:

<u>Pay Item</u>	<u>Pay Unit</u>
606.1301 31” W-Beam Guardrail - Mid-Way Splice – Single Faced	Linear Foot
606.1302 31” W-Beam Guardrail - Mid-Way Splice – Double Faced	Linear Foot
606.1303 31” W-Beam Guardrail - Mid-Way Splice, 15’ Radius and Less	Linear Foot
606.1304 31” W-Beam Guardrail - Mid-Way Splice, Over 15’ Radius	Linear Foot
606.1305 31” W-Beam Guardrail - Mid-Way Splice Flared Terminal	Each
606.1306 31” W-Beam Guardrail - Mid-Way Splice Tangent Terminal	Each
606.1307 Bridge Transition (Asymmetrical) – Type IA	Each
606.1721 Bridge Transition - Type I	Each
606.1722 Bridge Transition - Type II	Each
606.1731 Bridge Connection - Type I	Each
606.1732 Bridge Connection - Type II	Each
606.178 Guardrail Beam	Linear Foot
606.25 Terminal Connector	Each
606.257 Terminal Connector - Thrie Beam	Each
606.259 Anchorage Assembly	Each
606.265 Terminal End-Single Rail - Galvanized Steel	Each
606.266 Terminal End-Single Rail - Corrosion Resistant Steel	Each
606.275 Terminal End-Double Rail - Galvanized Steel	Each
606.276 Terminal End-Double Rail - Corrosion Resistant Steel	Each
606.352 Reflectorized Beam Guardrail Delineators (“Butterfly” type)	Each
606.3521 Linear Delineation System Panel	Each
606.353 Reflectorized Flexible Guardrail Marker	Each
606.354 Remove and Reset Reflectorized Flexible Guardrail Marker	Each
606.356 Underdrain Delineator Post	Each
606.358 Guardrail, Modify	Linear Foot
606.362 Guardrail, Adjust	Linear Foot
606.365 Guardrail, Remove, Modify, and Reset	Linear Foot
606.366 Guardrail, Remove and Reset	Linear Foot
606.367 Replace Unusable Existing Guardrail Posts	Each
606.3671 Replace Unusable Offset Blocks	Each
606.47 Single Wood Post	Each
606.48 Single Galvanized Steel Post	Each

606.50	Single Steel Pipe Post	Each
606.51	Multiple Mailbox Support	Each
606.568	Guardrail, Modify - Double Rail	Linear Foot
606.63	Thrie Beam Rail Beam	Linear Foot
606.64	Guardrail Thrie Beam - Double Rail	Linear Foot
606.65	Guardrail Thrie Beam - Single Rail	Linear Foot
606.66	Terminal End Thrie Beam	Each
606.70	Transition Section - Thrie Beam	Each
606.71	Guardrail Thrie Beam - 15 ft radius and less	Linear Foot
606.72	Guardrail Thrie Beam - over 15 ft radius	Linear Foot
606.73	Guardrail Thrie Beam - Single Rail Bridge Mounted	Linear Foot
606.74	Guardrail - Single Rail Bridge Mounted	Linear Foot
606.753	Widen Shoulder for Low Volume Guardrail End	Each
606.754	Widen Shoulder for Flared Guardrail Terminal	Each
606.78	Low Volume Guardrail End	Each
606.80	Buried-in-Slope Guardrail End	Each

SECTION 608 SIDEWALKS

Section 608.022 Detectable Warning Materials Standard Revise this section by removing the last sentence of this section beginning with “Concrete...” and replacing it with “**Concrete shall meet the requirements of Section 608.021, Sidewalk Materials, of this specification or may be a prepackaged concrete mix from the Department’s Qualified Products List (QPL).**”

SECTION 609 CURB

Remove this section in its entirety and replace with the following:

609.01 Description Construct or reset curb, gutter, or combination curb and gutter, paved ditch, and paved flume. The types of curb are designated as follows:

- Type 1 - Stone curbing of quarried granite stone
- Type 2 – Concrete Curbing
- Type 3 - Bituminous curbing
- Type 5 - Stone edging of quarried granite stone

609.02 Materials Except as provided below, the materials used shall meet the requirements of the following Sections of Division 700 - Materials:

Portland Cement and Portland Pozzolan Cement	701.01
Water	701.02
Air Entraining Chemical Admixture	701.03
Fine Aggregate for Concrete	703.01

Coarse Aggregate for Concrete	703.02
Joint Mortar	705.02
Reinforcing Steel	709.01
Stone Curbing and Edging	712.04
Epoxy Resin	712.35
Hot Mix Asphalt Curbing	712.36
Structural Precast Concrete Units (Concrete Curb)	712.061

The Contractor shall submit a concrete mix design for the Portland Cement Concrete to the Resident, for the uses specified below or in accordance with the Contract Documents.

Circular curb, terminal sections and transition sections shall be in reasonably close conformity with the shape and dimensions shown on the Plans and to the applicable material requirements herein for the type of curb specified.

Dowels shall be reinforcing steel deformed bars.

Concrete for Slipform Concrete Curb shall meet the requirements below:

- a. Class A, with the exception that permeability requirements shall be waived.
- b. Entrained air content of Slipform Concrete Curb shall be 4.0% to 7.0%
- c. Concrete temperature, prior to discharge, shall not exceed 90 F.
- d. Proposed mix designs may contain polypropylene fibers.
- e. Partially discharged loads may be retempered with water provided the maximum water to cement ratio is not exceeded.

609.03 Vertical Stone Curb, Terminal Section and Transition Sections and Portland Cement Concrete Curb, Terminal Sections and Transition Sections

a. Installation The curb stone shall be set on a compacted foundation so that the front top arris line conforms to the lines and grades required. The foundation shall be prepared in advance of setting the stone by grading the proper elevation and shaping to conform as closely as possible to the shape of the bottom of the stone. The required spacing between stones shall be assured by the use of an approved spacing device to provide an open joint between stones of at least ¼ inch and no greater than ⅝ inch.

b. Backfilling All remaining spaces under the curb shall be filled with approved material and thoroughly hand tamped so the stones will have a firm uniform bearing on the foundation for the entire length and width. Any remaining excavated areas surrounding the curb shall be filled to the required grade with approved materials. This material shall be placed in layers not exceeding 8 inches in depth, loose measure and thoroughly tamped.

When backfill material infiltrates through the joints between the stones, small amounts of joint mortar or other approved material shall be placed in the back portion of the joint to prevent such infiltrating.

c. Protection The curb shall be protected and kept in good condition. All exposed surfaces smeared or discolored shall be cleaned and restored to a satisfactory condition or the curb stone removed and replaced.

d. Curb Inlets Curb placed adjacent to curb inlets shall be installed with steel dowels cemented into each stone with epoxy grout as shown in the Standard Details.

The epoxy grout shall be used in accordance with the manufacturer's instructions. The grout shall be forced into the hole, after which the dowel shall be coated with grout for one-half its length and inserted into the grout filled hole. The hole shall be completely filled with grout around the dowel. All tools and containers must be clean before using.

The Contractor may elect to substitute concrete to backfill Stone Curbing or Stone Edging at their option. If the concrete backfill option is elected, the Concrete Fill shall meet the requirements of 609.02. The Contractor shall submit a concrete design for the Portland Cement Concrete, with a minimum designated compressive strength of 3000 PSI meeting the requirements of Class S or Class Fill Concrete. The Contractor may elect to choose a Prepackaged Concrete Mix from the Departments Qualified Products list (QPL). Concrete backfill shall be completed in conformance with a Department supplied concrete backfill detail.

609.04 Bituminous Curb

a. Preparation of Base Before placing the curb, the foundation course shall be thoroughly cleaned of all foreign and objectionable material. String or chalk lines shall be positioned on the prepared base to provide guidelines. The foundation shall be uniformly painted with tack coat at a rate of 0.04 to 0.14 gal/yd².

b. Placing The curb shall be placed by an approved power operated extruding type machine using the shape mold called for. A tight bond shall be obtained between the base and the curb. The Resident may permit the placing of curbing by other than mechanical curb placing machines when short sections or sections with short radii are required. The resulting curbing shall conform in all respects to the curbing produced by the machine.

c. When required, the curb shall be painted and coated with glass beads in accordance with Section 627 - Pavement Marking. Curb designated to be painted shall not be sealed with bituminous sealing compound.

d. Acceptance Curb may be accepted or rejected based on appearance concerning texture, alignment, or both. All damaged curb shall be removed and replaced at the Contractor's expense.

e. Polyester fibers shall be uniformly incorporated into the dry mix at a rate of 0.25 percent of the total batch weight. Certification shall be provided from the supplier with each shipment meeting the following requirements:

Average Length	0.25 inches \pm 0.005
Average Diameter	0.0008 inches \pm 0.0001
Specific Gravity	1.32-1.40
Melting Temperature	480 °F Minimum

609.05 Slipform Concrete Curb

a. Preparation of Base Before placing the curb, the foundation course shall be thoroughly cleaned of all foreign and objectionable material. The Contractor shall not place Slipform Concrete Curb on a wet or frozen foundation. The foundation (HMA or concrete) may be in a Saturated Surface Dry condition, but no standing water shall be allowed. String or chalk lines shall be positioned on the prepared foundation to provide guidelines. Prior to placing the curb, the foundation shall be uniformly coated with an epoxy resin adhesive that meets the requirements of AASHTO M 235, Type I, II, III, IV or V and has been tested by AASHTO Product Evaluation & Audit Solutions. The Contractor shall submit the epoxy resin adhesive that they propose to utilize with the concrete mix design. The epoxy resin adhesive must be approved prior to placement and used in accordance with manufacturer's recommendations.

b. Placing Concrete shall be placed with an approved Slipform machine that will produce a finished product according to the design specified in the Plans. For cold weather slip forming, the outside temperature must be at least 36°F and rising. The curb shall be placed on a firm, uniform foundation, shall conform to the section profile specified in the Plans, and shall match the appropriate grade. Expansion joints shall be placed in the curb where it meets rigid structures such as but not limited to building foundations, catch basin headers or fire hydrants. Contraction joints will be placed at 10-foot intervals using sawing methods, which shall cut 1 to 3 inches into the concrete. Contraction joints shall be cut between 1 and 7 days after placement of the concrete. Joints shall be constructed perpendicular to the subgrade and match other joints in roadways, sidewalks, or other structures when applicable.

c. Curing and Sealing Proper curing shall be provided using either a combination curing/sealing compound spray that meets ASTM 1315 Type 1-Class A, or a curing compound spray that meets ASTM 309 Type 1-D – Class A. Curing may also be accomplished by the methods specified in Standard Specification Section 502.14, Curing Concrete.

If a combination curing/sealing compound spray is not used, a separate sealing compound from the MaineDOT Qualified Products List for a Type 1c sealer shall be applied after the concrete has cured.

d. Protection Slipform curb must be adequately protected after placement. The concrete shall be allowed to cure for at least 72 hours. During cold weather conditions, when temperatures drop below the required temperature of 36°F after placement, curbing shall be protected by concrete blankets or a combination of plastic sheeting and straw. After any

placement of Slipform curb, regardless of weather conditions, the placed curb shall be adequately protected by traffic control devices as necessary.

e. Marking When required, the curb shall be painted and coated with glass beads in accordance with Section 627 - Pavement Marking. Curb designated to be painted shall not be sealed unless a combination curing/sealing compound is used.

f. Acceptance Curb shall be accepted or rejected based on finish, alignment, entrained air content, and compressive strength. Concrete Quality Control and Acceptance shall be done in accordance with Standard Specification Section 502, Method C. All damaged curb shall be removed and replaced at the Contractor's expense.

609.06 Stone Edging The curb shall be installed, backfilled and protected in accordance with Section 609.03, except as follows:

a. Slope The edging shall be set on a slope as shown on the Plans or as directed.

b. Joints Joints shall be open and not greater than 1½ inch in width.

609.07 Stone Bridge Curb

a. Installation Each stone and the bed upon which it is to be placed shall be cleaned and thoroughly wetted with water before placing the mortar for bedding and setting the stone. The stone shall be set on a fresh bed of joint mortar and well bedded before the mortar has set so that the front top arris line conforms to the line and grade required. Whenever temporary supporting wedges or other devices are used in setting the stones, they shall be removed before the mortar in the bed has become set, and the holes left by them shall be filled with mortar. Concrete behind the stones shall not be placed until the stones have been in place at least two days. Bedding and pointing mortar for joints shall be cured as required under Section 502 - Structural Concrete.

b. Joints Vertical joints shall be ½ inch in width plus or minus ⅛ inch. Whenever possible, the face and top of the joint shall be pointed with joint mortar to a depth of 1½ inch, before the bedding mortar has set. Joints which cannot be so pointed, shall be prepared for pointing by raking them to a depth of 1½ inch before the mortar has set. Joints not pointed at the time the stone is laid shall be thoroughly wetted with clean water and filled with mortar. The mortar shall be well driven into the joint and finished with an approved pointing tool, flush with the pitch line of the stones.

609.08 Resetting Stone or Portland Cement Concrete Curb, Including Terminal Sections and Transitions

The curb shall be installed, backfilled and protected in accordance with Section 609.03, except as follows:

a. Removal of Curbing The Contractor shall carefully remove and store curb specified on the Plans or designated for resetting. Curb damaged or destroyed, because of the

Contractor's operations or because of their failure to store and protect it in a manner that would prevent its loss or damage, shall be replaced with curbing of equal quality at the Contractor's expense.

b. Cutting and Fitting Cutting or fitting necessary in order to install the curbing at the locations directed shall be done by the Contractor.

609.09 Method of Measurement Curb, both new and reset, will be measured by the linear foot along the front face of the curb at the elevation of the finished pavement, complete in place and accepted. Curb inlets at catch basins, including doweling, will not be measured for payment but shall be considered included in the cost of the catch basin. New transition sections and terminal curb will be measured by the unit. Reset transition sections and terminal curb will be included in the measurement for resetting curb.

Concrete Slipform Curb and terminal ends will be measured by the linear foot along the front face of the curb at the elevation of the finished pavement, complete in place and accepted.

609.10 Basis of Payment The accepted quantities of curbing will be paid for at the contract unit price per linear foot for each kind and type of curbing as specified.

Payment for terminal curb shall include only that portion of the curbing modified for installation at ends of curb runs shown in the Standard Details. Curb adjacent to terminal ends shall be paid for at the contract unit price per linear foot for the type of curb installed.

Vertical Curb Type 1 is required to have a radius of 60 feet or less, will be paid for as Vertical Curb Type 1 - Circular.

Curb, Type 5 required to have a radius of 30 feet or less will be paid for as Curb Type 5 - Circular.

There will be no separate payment for concrete fill, mortar, reinforcing steel, anchors, tack coat, drilling for and grouting anchors, pointing and bedding of curbing, and for cutting and fitting, but these will be considered included in the work of the related curb.

Removal of existing curb and necessary excavation for installing new or reset curbing will not be paid for directly but shall be considered to be included in the appropriate new or reset curb pay item. Base and Subbase material will be paid for under Section 304 - Aggregate Base and Subbase Course. Backing up bituminous curb is incidental to the curb items. Loam, as directed, will be paid under 615 – Loam.

SECTION 619
MULCH

619.03 General Amend this Section by adding the following sentence to the end: **“Straw mulch shall be used in all wetland areas.”**

SECTION 626
FOUNDATIONS, CONDUIT, AND JUNCTION BOXES FOR HIGHWAY
SIGNING, LIGHTING, AND SIGNALS

Section 626.021 Miscellaneous Materials Revise this section by removing the fourth paragraph beginning with “ All Concrete for concrete encasement...” and replace it with **“All concrete for concrete encasement of conduit shall be Class S or Class Fill concrete in accordance with the applicable requirements of Section 502 – Structural Concrete, or a Prepackaged Concrete Mix from the Department’s Qualified Products List (QPL).”**

Section 626.031 Conduit Revise the fifth paragraph beginning with “After the trench has been...” by removing the last sentence beginning with “Where concrete encasement...” and replacing it with **“Where concrete encasement is required around the conduit, the concrete shall meet Class S, Class Fill in accordance with the applicable requirements of Section 502 – Structural Concrete, or a Prepackaged Concrete Mix from the Department’s Qualified Products List (QPL).”**

626.034 Concrete Foundations Revise this Section by changing ‘626.037’ to ‘**626.036**’ in the Second Paragraph which begins with “Foundations shall consist of cast-in-place...”.

Revise the 10th paragraph beginning with “Before placing concrete, the required elbows...” by removing “...in accordance with **Standard Specification 633.**”

626.036 Precast Foundations Revise the last sentence of paragraph one so that it reads: **“Construction of precast foundations shall conform to the Standard Details and all requirements of 712.061.”**

SECTION 627
PAVEMENT MARKINGS

627.02 Materials Amend this section by adding the following to the existing Specification:

“When pavement marking paint must be applied on pavement with an air temperature between 35 °F and 50 °F, a low temperature waterborne paint may be used upon the Department’s approval as noted below.

The Contractor shall submit the following information for Department review and approval at least 10 calendar days prior to application:

The manufacturer and product name of the low temperature waterborne paint

The manufacturer's technical product data sheets

The product's SDS sheets

All required and recommended application specifications for the product

The manufacturer's requirements for temperature, surface preparation, paint thickness and the bead application shall be followed. No additional payment will be made for the use of low temperature waterborne paint. “

627.06 Application Revise this subsection by replacing the paragraph beginning with “ On other final pavement markings...” with the following:

“On other final pavement markings and on curb, where the paint is applied by hand painting or spraying, application shall be one uniform covering coat at least 16 mils thick. Before the paint has dried, the glass beads shall be applied by a pressure system that will force the glass beads onto the undried paint as uniformly as possible.

Painted lines and markings shall be applied in accordance with the manufacturer's published recommendations. These recommendations will be supplied to the Resident prior to installation.”

Revise this subsection by replacing the paragraph beginning with “ If the final reflectivity values are less...” with the following:

“The final reflectivity will be acceptable if 90 percent or more of the painted pavement lines and markings meet the specified minimum value. If less than 90 percent of the painted pavement lines and markings meet the specified minimum final reflectivity values, the Contractor shall repaint those areas not meeting required reflectivity at no cost to the Department.

If, after repainting, analysis of the final reflectivity values results in the need for a second repainting, the Contractor will submit in writing a plan of action to meet the reflectivity minimums prior to continuing any work. Once the plan has been reviewed and approved by the Department, the Contractor shall reapply at no cost to the Department.”

SECTION 634 HIGHWAY LIGHTING

634.021 Materials Revise this subsection by removing the paragraph beginning with “All bolts for mounting lighting fixtures” and replacing with:

“All bolts for mounting lighting fixtures under bridge structures shall conform to the requirements of ASTM A307. These bolts and other fastening hardware shall be galvanized in

accordance with AASHTO M 232 (ASTM A153), ASTM F2329, or ASTM B695, Class 50, Type I.”

SECTION 637 DUST CONTROL

Revise this section by removing it in its entirety.

SECTION 643 TRAFFIC SIGNALS

643.021 Materials Amend this subsection by adding the following at the end:

“MaineDOT is transitioning to MASH2016 criteria for Work Zone Traffic Control Devices on the following schedule:

Temporary Traffic Control Signals will be crash tested and/or evaluated to MASH2016 criteria by January 1, 2030. Current Category 4 devices in useful serviceable condition that are successfully tested to NCHRP Report 350 or MASH2009 criteria may be utilized through December 31, 2029.”

643.023 Traffic Signal Structures Remove the third paragraph and replace it with the following:

“Traffic signal support structures shall be classified as Fatigue Category III if they are located on roads with a speed limit of 35 mph or less, Fatigue Category II if they are located on roads with a speed limit of greater than 35 mph, and Fatigue Category I if noted on the Contract Plans. Fatigue Importance Factors shall be as specified in Table 11.6-1 (Fatigue Importance Factors). Fatigue analyses are not required for span-wire (strain) pole traffic signal support structures with heights of 55 feet or less unless required by the current edition of AASHTO “LRFD Specifications for Structural Supports for Highway Signs, Luminaires, and Traffic Signals”.

643.09 Service Connection Revise this subsection by removing the paragraph that begins with “Traffic signal services shall have...”.

And by removing the paragraphs beginning with “ A service ground rod shall be installed...” and “A total of 4, 10’ service...” and replace them with **“A total of 4, 10’ service ground rods shall be installed and properly connected together on the outside of the cabinet foundation. One ground rod shall be located at each corner and shall be either flush or slightly below finished grade. The connection between the ground rod and the ground wire shall be an**

exothermic connection such as a Cadweld. The ground wire from the interconnected ground rods shall be routed through a conduit in the foundation and into the base of the cabinet”.

SECTION 645 HIGHWAY SIGNING

Section 645.023 Sign Support Structures. Under letter “c.”, revise the fifth paragraph beginning with “In addition to the required details...” by removing the words **”and foundation”** from the 5th sentence.

Section 645.08 Method of Measurement. Revise the second paragraph beginning with “Bridge-type, cantilever and...” by removing the words **”including the foundation”** .

Section 645.09 Basis of Payment. Revise the third paragraph beginning with “The accepted bridge-type, cantilever and...” by removing the word **”foundation”** from the second sentence. Add the following sentence to the end of the paragraph **“Conduits, Junction Boxes, and Foundations will be paid for under Section 626.”**

SECTION 652 MAINTENANCE OF TRAFFIC

652.2.5 Portable Changeable Message Sign Revise the fifth paragraph so it reads:

“The control system shall include a display screen upon which messages can be reviewed before being displayed on the message sign. The control system shall be capable of maintaining memory when power is unavailable. Messages must be changeable with either a portable electronic device like a notebook computer or an on-board keypad. The controller shall have the capability to store a minimum of 200 user-defined and 200 pre-programmed messages. Controller and battery compartments shall be enclosed in lockable, weather-tight boxes. The cabinet shall be locked at all times that the Contractor is not actively changing the message. The Contractor shall change the password for the controller prior to stationing the PCMS and shall provide the password to the Resident. The password shall be unique per PCMS and secure and shall not be written anywhere in, on, around, or stored in the PCMS.”

Amend this Section by adding the following new subsection:

“652.2.6 Device Crashworthiness **MaineDOT is transitioning to MASH2016 criteria for Work Zone Traffic Control Devices on the following schedule:**

Category 1 (Cones, Drums, Tubular Markers, Flexible Delineators, and similar devices that have little chance if causing windshield penetration, tire damage, or other significant effect on the control or trajectory of a vehicle) – All Category 1 devices will be manufacturer self-certified as MASH2016 by January 1, 2025. Current Category 1 devices in useful serviceable condition that are not self-certified as MASH2016 compliant may be utilized through December 31, 2024.

Category 2 (Barricades, Portable Sign Supports, Category 1 devices with attachments, and similar devices that are not expected to produce significant vehicular velocity change but may be otherwise hazardous) – All Category 2 devices will be crash tested and/or evaluated to MASH2016 criteria by January 1, 2025. Current Category 2 devices in useful serviceable condition that are successfully tested to NCHRP Report 350 or MASH2009 criteria may be utilized through December 31, 2024.

Category 3 (Portable Concrete Barrier, Portable Crash Cushions, Truck Mounted Attenuators, Category 2 devices weighing more than 100 pounds, and similar devices that are expected to produce significant vehicular velocity change or other harmful reactions) – All Category 3 devices will be crash tested and/or evaluated to MASH2016 criteria by January 1, 2030. Current Category 3 devices in useful serviceable condition that are successfully tested to NCHRP Report 350 or MASH2009 criteria may be utilized through December 31, 2029. (See Standard Specification 526 for additional Portable Concrete Barrier information).

Category 4 (Trailer Mounted Devices: Arrow Boards, Temporary Traffic Control Signals, Area Lighting, Portable Changeable Message Sign, and other similar devices.) – All Category 4 devices will be crash tested and/or evaluated to MASH2016 criteria by January 1, 2030. Current Category 4 devices in useful serviceable condition that are successfully tested to NCHRP Report 350 or MASH2009 criteria may be utilized through December 31, 2029.”

652.3.3 Submittal of Traffic Control Plan Amend this section by adding:

“n. A security plan for any PCMS shall be included. The Contractor shall provide a plan for secure access to the PCMS and protection from unauthorized users. The plan shall have details on securing the cabinets via a lock and password from unauthorized users, password changing protocols, and where the access information will be kept so it can be used in the event of emergency. The Contractor shall not Identify or store passwords in the TCP.”

652.4 Flaggers Revise the first paragraph of this section so that it reads:

“The Contractor shall furnish flaggers as required by the TCP or as otherwise specified by the Resident. All flaggers must have successfully completed a flagger test approved by the Department and administered by a Department-approved Flagger-Certifier who is employing that flagger. All flaggers must carry an official certification card with them while flagging that has been issued by their employer.”

SECTION 681

PRECAST AGGREGATE-FILLED, CONCRETE BLOCK GRAVITY WALL

681.08 Basis of Payment Amend this section by adding the Item Number “**681.10**” in front of the item “Precast Aggregate-Filled Concrete Block Gravity Wall” at the end of the section.

SECTION 701
STRUCTURAL CONCRETE RELATED MATERIAL

701.01 Portland Cement and Portland Pozzolan Cement Amend the first sentence of Paragraph 3 by adding “**or Type 1L Portland Limestone cement**” so that it reads:

“A Type IP (MS) Portland-pozzolan cement (blended hydraulic cement with moderate sulfate resistance) or Type 1L Portland Limestone cement meeting the requirements of AASHTO M 240, may be used instead of Type II or where Type I Portland cement, meeting the requirements of AASHTO M 85, is allowed.”

SECTION 703
AGGREGATES

Add the following to Section 703 - Aggregates

703.01 Fine Aggregate for Concrete Fine aggregate for concrete shall consist of natural sand or, when approved by the Resident, other inert materials with similar characteristics or combinations thereof, having strong, durable particles. Fine aggregate from different sources of supply shall not be mixed or stored in the same pile nor used alternately in the same class of construction or mix without permission of the Resident.

All fine aggregate shall be free from injurious amounts of organic impurities. Should the fine aggregate, when subjected to the colorimetric test for organic impurities, AASHTO T 21, produce a color darker than the reference standard color solution (laboratory designation Plate III), the fine aggregate shall be rejected.

Fine aggregate shall have a sand equivalent value of not less than 75 when tested in accordance with AASHTO T 176.

Fine aggregate sources shall meet the Alkali Silica Reactivity (ASR) requirements of Section 703.0201.

The fineness modulus shall not be less than 2.26 or more than 3.14. If this value is exceeded, the fine aggregate will be rejected unless suitable adjustments are made in proportions of coarse and fine aggregate. The fineness modulus of fine aggregate shall be determined by adding the cumulative percentages of material by weight retained on the following sieves: Nos. 4, 8, 16, 30, 50, 100 and dividing by 100.

Fine aggregate, from an individual source when tested for absorption as specified in AASHTO T 84, shall show an absorption of not more than 2.3 percent.

Sieve Designation	Percentage by Weight Passing Square Mesh Sieves
3/8 inch	100
No. 4	95-100
No. 8	80-100
No. 16	50-85
No. 30	25-60
No. 50	10-30
No. 100	2-10
No. 200	0-5.0

703.02 Coarse Aggregate for Concrete Coarse aggregate for concrete shall consist of crushed stone or gravel having hard, strong, durable pieces, free from adherent coatings and of which the composite blend retained on the 3/8 inch sieve shall contain no more than 15 percent, by weight of flat and elongated particles when performed in accordance with test method ASTM D 4791, Flat Particles, Elongated Particles, or Flat and Elongated Particles in Coarse Aggregate, using a dimensional ratio of 1:5.

The coarse aggregate from an individual source shall have an absorption no greater than 2.0 percent by weight determined in accordance with AASHTO T 85 modified for weight of sample.

The composite blend shall have a Micro-Deval value of 18.0 percent or less as determined by AASHTO T 327 or not exceed 40 percent loss as determined by AASHTO T 96.

Coarse aggregate sources shall meet the Alkali Silica Reactivity (ASR) requirements of Section 703.0201.

Coarse aggregate shall conform to the requirements of the following table for the size or sizes designated and shall be well graded between the limits specified.

Sieve Designation	Percentage by Weight Passing Square Mesh Sieves						
	S	A	AA	SP-1-7	SP-1-78	SP-2-8	SP-2-89
Aggregate Size	1 ½ inch	1 inch	¾ inch	½ inch	½ inch	⅜ inch	⅜ inch
2 inch	100						
1 ½ inch	95-100	100					
1 inch	-	95-100	100				
¾ inch	35-70	-	90-100	100	100		
½ inch	-	25-60	-	90-100	90-100	100	100
⅜ inch	10-30	-	20-55	40-70	40-75	85-100	90-100
No. 4	0-5	0-10	0-10	0-15	5-25	10-30	20-55
No. 8	-	0-5	0-5	0-5	0-10	0-10	5-30
No. 16	-	-	-	-	0-5	0-5	0-10
No. 50	-	-	-	-	-	-	0-5
No. 200*	0-1.5	0-1.5	0-1.5	0-1.5	0-1.5	0-1.5	0-1.5

*This limit will be 0-2.0 for Department production samples. Yearly quality samples will be held to 0-1.5.

703.0201 Alkali Silica Reactive Aggregates All coarse and fine aggregates proposed for use in concrete shall be tested for Alkali Silica Reactivity (ASR) potential under AASHTO T 303 (ASTM C 1260), Accelerated Detection of Potentially Deleterious Expansion of Mortar Bars Due to Alkali-Silica Reaction, prior to being accepted for use. Acceptance will be based on testing performed by an accredited independent lab submitted to the Department. Aggregate submittals will be required on a 5-year cycle, unless the source or character of the aggregate in question has changed within 5 years from the last test date.

As per AASHTO T 303 (ASTM C 1260): Use of a particular coarse or fine aggregate will be allowed with no restrictions when the mortar bars made with this aggregate expand less than or equal to 0.10 percent at 30 days from casting. Use of a particular coarse or fine aggregate will be classified as potentially reactive when the mortar bars made with this aggregate expand greater than 0.10 percent at 30 days from casting. Use of this aggregate will only be allowed with the use of cement-pozzolan blends and/or chemical admixtures that result in mortar bar expansion of less than 0.10 percent at 30 days from casting as tested under ASTM C 1567.

Acceptable pozzolans and chemical admixtures that may be used when an aggregate is classified as potentially reactive include, but are not limited to the following:

- a. Class F Coal Fly Ash meeting the requirements of AASHTO M 295
- b. Ground Granulated Blast Furnace Slag (Grade 100 or 120) meeting the requirements of AASHTO M 302
- c. Densified Silica Fume meeting the requirements of AASHTO M 307
- d. Lithium-based admixtures
- e. Metakaolin

Pozzolans or chemical admixtures required to offset the effects of potentially reactive aggregates will be incorporated into the concrete at no additional cost to the Department.

Amend this section by adding the new sub section:

“703.03 Combined Aggregate Grading for Concrete The combined gradation of the fine and coarse aggregates when mathematically blended using the mix design percentages shall conform to the requirements of the following table for the size or sizes designated and shall be well graded between the limits specified.

Sieve Designation	Percentage by Weight Passing Square Mesh Sieves						
	Grading	S	A	AA	SP-1-7	SP-1-78	SP-2-8
Aggregate Size	1½ inch	1 inch	¾ inch	½ inch	½ inch	⅜ inch	⅜ inch
2 inch	100						
1½ inch	95–100	100					
1 inch	80–100	95–100	100				
¾ inch	55–90	90–100	93–100	100	100		
½ inch	45–80	55–80	60–90	90–100	90–100	100	100
⅜ inch	40–65	40–65	50–80	55–85	65–90	90–100	90–100
No. 4	35–55	35–55	35–60	30–60	40–70	45–75	50–80
No. 8	25–53	28–50	30–55	25–55	30–65	35–65	35–75
No. 16	15–40	18–45	19–45	18–50	20–55	20–55	20–55
No. 30	7–30	9–30	10–33	8–32	10–38	10–38	10–40
No. 50	3–14	4–14	4–16	3–16	4–20	4–20	4–20
No. 100	0–6	0–6	0–6	0–6	0–7	0–8	0–8
No. 200	0–3.5*	0–3.5*	0–3.5*	0–3.5*	0–3.5*	0–3.5*	0–3.5*

*The percent passing the No. 200 sieve shall not exceed 6.0 percent for any fine aggregate. The percent passing the No. 200 sieve shall not exceed 2.0 percent for any single coarse aggregate. The percent passing the No. 200 sieve shall not exceed 4.0 percent for the combined gradation of self-consolidating concrete (SCC) mix designs.”

703.05 Aggregate for Sand Leveling Aggregate for sand leveling shall be sand of hard durable particles free from vegetable matter, lumps or balls of clay and other deleterious substances. The aggregate shall meet the grading requirements of the following table.

Sieve Designation	Percentage by Weight Passing Square Mesh Sieves
⅜ inch	85-100
No. 200	0-5.0

703.06 Aggregate for Base and Subbase The following shall apply to Sections (a.) and (c.) below. The material shall have a Micro-Deval value of 25.0 or less as determined by AASHTO T 327. If the Micro-Deval value exceeds 25.0, the Washington State Degradation DOT Test Method T113, Method of Test for Determination of Degradation Value (January 2009 version) shall be performed, except that the test shall be performed on the portion of the sample that passes the ½ in sieve and is retained on the No. 10 sieve. If the material has a Washington Degradation value of less than 15, the material shall be rejected. The material used in Section (b.) below shall have a Micro-Deval value of 25.0 or less as determined by AASHTO T 327. If the Micro-Deval value exceeds 25.0 the material may be used if it does not exceed 25 percent loss on AASHTO T 96, Resistance to Degradation of Small-Size Coarse Aggregate by Abrasion and Impact in the Los Angeles Machine.

Recycled Asphalt Pavement (RAP) shall not be used for or blended with aggregate base or subbase.

- a. Aggregate for base, Type A and B shall be crushed ledge or crushed gravel of hard durable particles free from vegetable matter, lumps or balls of clay and other deleterious substances. The gradation of the part that passes a 3 inch sieve shall meet the grading requirements of the following table:

Sieve Designation	Percentage by Weight Passing Square Mesh Sieves	
	Type A	Type B
½ inch	45-70	35-75
¼ inch	30-55	25-60
No. 40	0-20	0-25
No. 200	0-6.0	0-6.0

At least 50 percent by weight of the material retained on the No. 4 sieve shall have at least one fractured face as tested by AASHTO T 335.

Type A aggregate for base shall only contain particles of rock that will pass the 2 inch square mesh sieve.

Type B aggregate for base shall only contain particles of rock that will pass the 4 inch square mesh sieve.

- b. Aggregate for base, Type C shall be crushed ledge or crushed gravel of hard durable particles free from vegetable matter, lumps or balls of clay and other deleterious substances. The material shall meet the grading requirements of the following table:

Sieve Designation	Percentage by Weight Passing Square Mesh Sieves	
	Type C	
4 inches	100	
3 inches	90-100	
2 inches	75-100	
1 inch	50-80	
½ inch	30-60	
No. 4	15-40	
No. 200	0-6.0	

At least 50 percent by weight of the material coarser than the No. 4 sieve shall have at least one fractured face as tested by AASHTO T 335.

c. Aggregate for subbase shall be sand or gravel of hard durable particles free from vegetable matter, lumps or balls of clay and other deleterious substances. The gradation of the part that passes a 3 inch sieve shall meet the grading requirements of the following table:

Sieve Designation	Percentage by Weight Passing Square Mesh Sieves	
	Type D	Type E
½ in	35-80	
¼ inch	25-65	25-100
No. 40	0-30	0-50
No. 200	0-7.0	0-7.0

Type D aggregate for subbase gravel may contain up to 50 percent by weight Recycled Concrete Aggregate (RCA). When RCA is used, the portion of the resulting blend of gravel and RCA retained on a ½” square mesh sieve shall contain a total of no more than 5 percent by weight of other recycled materials such as brick, concrete masonry block, or asphalt pavement as determined by visual inspection.

RCA shall be substantially free of wood, metal, plaster, and gypsum board as defined in Note 9 in Section 7.4 of AASHTO M 319. RCA shall also be free of all substances that fall under the category of solid waste or hazardous materials.

Aggregate for subbase shall not contain particles of rock which will not pass the 6 inch square mesh sieve.

703.08 Recycled Asphalt Pavement Recycled asphalt pavement shall consist of salvaged asphalt materials from milled pavements or production waste that has been processed before use to meet the requirements of the job mix formula. It shall be free of winter sand, granular fill, construction debris, or other materials not generally considered asphalt pavement.

703.081 RAP for Asphalt Pavement Recycled Asphalt Pavement (RAP) may be introduced into hot-mix asphalt pavement at percentages approved by the Department according to the MaineDOT Policies and Procedures for HMA Sampling and Testing.

If approved by the Department, the Contractor shall provide documentation stating the source, test results for average residual asphalt content, and stockpile gradations showing RAP materials have been sized to meet the maximum aggregate size requirements of each mix designation. The Department will obtain samples for verification and approval prior to its use.

The maximum allowable percent of RAP shall be determined by the asphalt content, the percent passing the 0.075 mm sieve, the ratio between the percent passing the 0.075 mm sieve and the asphalt content, and Coarse Micro-Deval loss values as tested by the Department.

The maximum percentage of RAP allowable shall be the lowest percentage as determined according to Table 4 below:

Classification	Maximum RAP Percentage Allowed	Asphalt content standard deviation	Percent passing 0.075 mm sieve standard deviation	Percent passing 0.075 mm sieve / asphalt content ratio	Residual aggregate M-D loss value
Class III	10%	≤ 1.0	N/A	≤ 4.0	≤ 18
Class II	20%	≤ 0.5	≤ 1.0	≤ 2.8	
Class I	30%	≤ 0.3	≤ 0.5	≤ 1.8	

Table 4: Maximum Percent RAP According to Test Results

The Department will monitor RAP asphalt content and gradation during production by testing samples from the stockpile at approximately 15,000 T intervals (in terms of mix production). The allowable variance limits (from the numerical average values used for mix designs) for this testing are determined based upon the maximum allowable RAP percentage and are shown below in Table 5.

Table 5: RAP Verification Limits

Classification	Asphalt content (compared to aim)	Percent passing 0.075 mm sieve (compared to aim)
Class III	± 1.5	± 2.0
Class II	± 1.0	± 1.5
Class I	± 0.5	± 0.7

For specification purposes, RAP will be categorized as follows:

Class III – A maximum of 10.0 percent of Class III RAP may be used in any base, intermediate base, surface, or shim mixture. A maximum of 20.0 percent of Class III RAP may be used in hand-placed mixes for item 403.209.

Class II – A maximum of 20.0 percent Class II RAP in any base, binder, surface, or shim course.

Class I – A maximum of 20.0 percent Class I RAP may be used in any base, intermediate base, surface, or shim mixture without requiring a change to the specified asphalt binder. A maximum of 30.0 percent Class I RAP may be used in in any base or intermediate base mixture provided that a PG 58-28 or PG 58-34 asphalt binder is used. A maximum of 30.0 percent Class I RAP may be used in any surface or shim mixture provided that PG 58-34 asphalt binder is used. Mixtures exceeding 20.0 percent Class I RAP must be evaluated and approved by the Department.

The Contractor may use up to two different RAP sources in any one mix design. The total RAP percentage of the mix shall not exceed the maximum allowed for the highest classification RAP source used (i.e. if a Class I & Class III used, total RAP must not exceed 30.0%). The blended RAP material must meet all the requirements of the classification for which the RAP is entered (i.e. 10% Class III with 20% Class I, blend must meet Class I criteria). The Department may take belt cuts of the blended RAP to verify the material meets these requirements. If the Contractor elects to use more than one RAP source in a design, the Contractor shall provide an acceptable point of sampling blended RAP material from the feed belt.

In the event that RAP source or properties change, the Contractor shall notify the Department of the change and submit new documentation stating the new source or properties a minimum of 72 hours prior to the change to allow for obtaining new samples and approval.

Revise this Section by removing 703.7 and 703.9 in its entirety and replace with the following:

703.07 Aggregates for HMA Pavements Coarse and fine aggregate for hot mix asphalt pavements shall be of such gradation that when combined in the proper proportions, including filler, if required, the resultant blend will meet the composition of mixture for the type of pavement specified.

Coarse aggregate, that material retained on the No. 4 sieve, shall be crushed stone or crushed gravel and, unless otherwise stipulated, shall consist of clean, tough, durable fragments free from an excess of soft or disintegrated pieces and free from stone coated with dirt or other objectionable matter. Coarse aggregate shall not exceed an absorption of 2.0 percent by weight as determined by AASHTO T 85.

Fine aggregate, material that passes the No. 4 sieve, shall consist of natural sand, manufactured sand, or a combination of these. It shall consist of hard, tough grains, free from injurious amounts of clay, loam, or other deleterious substances. Fine aggregate shall not exceed an absorption of 2.3 percent by weight as determined by AASHTO T 84.

All individual aggregates for hot mix asphalt pavements shall meet Table 3 requirements (excluding LCP) unless otherwise noted. The Department reserves the right to sample and test the aggregate for any of the following properties at any time:

TABLE 3: Aggregate Consensus Properties Criteria

Estimated Traffic, Million 18 kip ESALs	AASHTO T 335 (minimum %)	AASHTO T 304 Method A **	ASTM D 4791 Method B	AASHTO T 176	Aggregate shall meet at least one of these:		
					AASHTO T 327	AASHTO T 96	WSDOT T 113*
< 3.0	75/60	≥ 40%	≤ 10%	≥ 45	≤ 18.0%	≤ 40%	≥ 30
3.0 to < 10	90/80	≥ 45%		≥ 50		≤ 35%	
≥ 10	95/90					≤ 30%	N/A

* As determined by Washington State DOT Test Method T 113, Method of Test for Determination of Degradation Value except that the reported degradation value will be the result of testing a single composite specimen from that portion of the sample that passes the ½ inch sieve and is retained on the No. 10 sieve.

** Property will be evaluated on a mix design basis by calculating a weighted average based upon individual aggregate values (weighted average by the percentage proportion of the aggregate within the design).

AASHTO T 335 - “90/80” denotes that 90 percent of the coarse aggregate has one fractured face and 80 percent has two fractured faces.

AASHTO T 304 - Criteria are presented as percent air voids in loosely compacted fine aggregate, (U).

ASTM D4791 - Criteria are presented as maximum percent by weight of flat and elongated particles (5:1 ratio).

The entire HMA wearing course shall come from the same source of material and the same job mix formula, except when permission is obtained from the Department to change sources.

703.09 HMA Mixture Composition The coarse and fine aggregate shall meet the requirements of Section 703.07. The several aggregate fractions for mixtures shall be sized, graded, and combined in such proportions that the resulting composite blends, including RAP aggregate will meet the grading requirements of the following table:

Aggregate Gradation Control Points

Nominal Maximum Aggregate Size---Control Points (Percent Passing)						
Sieve Designation	Type 25 mm	Type 19 mm	Type 12.5 mm	Type 9.5 mm	Type 9.5 mm Thin Lift Mixture (TLM)	Type 4.75 mm
Percent By Weight Passing - Combined Aggregate						
37.5 mm	100					
25 mm	90-100	100				
19 mm	-90	90-100	100			
12.5 mm	-	-90	90-100	100	100	100
9.5 mm	-	-	-90	90-100	95-100	95-100
4.75 mm	-	-	-	-90	60-95	80-100
2.36 mm	19-45	23-49	28-58	32-67	47-65	40 - 80
1.18 mm	-	-	-	-	-	-
0.60 mm	-	-	-	-	-	-
0.30 mm	-	-	-	-	-	-
0.075 mm	2.0-6.0	2.0-6.0	2.0-6.0	2.0-7.0*	2.0-7.0*	2.0-7.0

* For 9.5 mm nominal maximum aggregate size mixtures, the maximum design aim for the percent passing the 75 µm sieve is 6.5%.

SECTION 709 REINFORCING STEEL AND WELDED STEEL WIRE FABRIC

709.01 Reinforcing Steel Remove the second paragraph of Section 709.01 of the standard specification beginning with “Low-Carbon, Chromium,…” and replace with the following:

“ Low-carbon, chromium, reinforcing steel shall be deformed bars conforming to the requirements of ASTM A1035. Bars shall be Grade 100 and alloy Type CS unless otherwise specified on the Plans. “

SECTION 710 FENCE AND GUARDRAIL

710.06 Fence Posts and Braces Revise the first Paragraph so that it reads:

“Wood posts shall be of cedar, white oak, or tamarack or other AWPAs approved species, of the diameter or section and length shown on the plans.”

Remove the fourth paragraph which starts “ That portion of wood posts...”.

Revise the paragraph beginning with “Braces shall be of spruce, eastern hemlock ... so that it now reads:

“Braces shall be of spruce, eastern hemlock, Norway pine, pitch pine, or tamarack timbers or other AWPAs approved species, or spruce, cedar, tamarack or other AWPAs approved species round posts of sufficient length to make a diagonal brace between adjacent posts. All wood posts and braces shall be pressure-treated in accordance with AASHTO M 133 and AWPAs U1, UC4A Commodity Specification B: Posts. “

710.07 Guardrail Posts Revise this section so that the first sentence of section a. reads:

“a. Wood posts shall be of Norway pine, southern yellow pine, pitch pine, Douglas fir, red pine, white pine, or eastern hemlock or other AWPAs approved species.”

Revise the next paragraph so that it reads:

Wood posts and offset brackets shall be preservative treated in accordance with the requirements of AASHTO M 133 and AWPAs U1, UC4A Commodity Specification B: Posts.

710.08 Guardrail Hardware Revise this subsection by replacing “AASHTO M 298” with “ASTM B695”

SECTION 711 MISCELLANEOUS BRIDGE MATERIAL

711.06 Stud Shear Connector Anchors and Fasteners Amend this section by deleting it in its entirety and replacing it with:

“Shear connectors shall meet the dimensional tolerances of Figure 9.1 of the ANSI/AASHTO/AWS D1.5 Bridge Welding Code (D1.5 Code). Shear connectors, anchors and fasteners shall meet the material requirements of Section 9 of the D1.5 Code. Shear connectors shall meet the mechanical property requirements of Table 9.1, Type B of the D1.5 Code. Anchors and fasteners shall meet the mechanical property requirements of Table 9.1 of the D1.5 Code, Type A.”

SECTION 712
MISCELLANEOUS HIGHWAY MATERIAL

712.061 Structural Precast Units Amend this section by adding the following sentence to the end of the first paragraph of the Construction subsection:

“Facilities certified by NPCA or PCI shall provide to the Fabrication Engineer a copy of their annual audit to include deficiency reports and corrective actions.”

Revise this section by changing the letter “b” of ASTM C1611 of the Concrete Testing subsection so that it reads:

“b. Air content shall be 5.0% to 8.0%.”

SECTION 713
STRUCTURAL STEEL AND RELATED MATERIAL

Section 713.01 Structural Steel Replace paragraph two in its entirety with the following:

“Main load-carrying components subject to tensile stresses or stress reversal shall meet the notch toughness requirements in AASHTO M 270M, Table 11, Zone 2, for non-fracture critical steel or Table 12, Zone 2 for fracture critical steel. Frequency of tension tests shall comply with the requirements of S1.”

Section 713.02 High Strength Bolts Revise this subsection by removing the portion from the beginning up to and including TABLE 1 – Test Schedule*, and replace it with:

“Bolts shall conform to the requirements of ASTM F3125, Grade A325, Type 1 or Type 3. Type 3 bolts shall be supplied for all structures utilizing unpainted AASHTO M 270M weathering steel. Type 1 galvanized bolts shall be used for all structures utilizing metallized or galvanized steel.

Nuts shall meet the requirements of ASTM A563.

Circular and beveled washers shall conform to the requirements of ASTM F436.

Direct Tension Indicators (DTI’S) shall conform to the requirements of ASTM F959. DTI’s for use with painted steel shall have a plain “as fabricated” finish. DTI’s for use with unpainted steel shall be galvanized to the requirements of ASTM B695 Class 50, Type I and have a fusion-bonded epoxy coating. DTI’s used with galvanized steel, metallized steel and steel coated with a zinc-rich primer shall be galvanized to the requirements of ASTM B695 Class 50, Type I.

“Twist Off” Type Tension Control Structural Bolt/Nut/Washer Assemblies shall meet the requirements of ASTM F3125, Grade F1852.

Bolts, nuts and washers specified to be galvanized, shall be galvanized in accordance with AASHTO M 232 (ASTM A153), ASTM F2329, or ASTM B695 Class 50, Type I.

All fastener (bolts and nuts), whether black or galvanized, shall be coated with a suitable lubricant. Galvanized nuts shall be lubricated with a lubricant containing a visible dye.

Each lot of bolts, nuts, washers and DTI's shall be tested by the manufacturer in accordance with the tests tabulated in Table 1 - Test Schedule. The testing frequency for bolts, nuts and washers from each shipping lot of fasteners shall be as specified in the applicable AASHTO/ASTM Standard Specifications. The testing frequency for each production lot of DTI's shall be as specified in ASTM F959.

TABLE 1 - Test Schedule*

Bolts	Tensile Strength (Wedge Test)	ASTM F606
	Proof Load	ASTM F606
	Hardness	ASTM F606
	Coating Thickness	ASTM B695
Nuts	Proof Load	ASTM F606
	Hardness	ASTM F606
	Coating Thickness	ASTM B695
Washers	Hardness	ASTM F606
	Coating Thickness	ASTM B695
DTI's	Coating Thickness	ASTM B695
	Compression Load	ASTM F959

Section 716

STRUCTURAL ALUMINUM AND RELATED MATERIAL

716.01 Aluminum Railings: Revise this subsection by removing section d. and replacing with:

d. Steel Anchor Assembly Steel spacers for post anchors shall conform to the requirements of ASTM A36. Nuts embedded in concrete shall conform to the requirements of ASTM A307.

Anchor bolts, exposed nuts and washers shall conform to the requirements of ASTM A449 or ASTM F1554, Grade 55 and shall be galvanized in accordance with AASHTO M 232 (ASTM A153), ASTM F2329, or ASTM B695, Class 50, Type I.

SECTION 718

TRAFFIC SIGNALS MATERIAL

718.03 Signal Mounting Amend the paragraph beginning with “All trunions, brackets and...” by adding “**For polycarbonate signal heads with more than 3 sections or requiring mounting extensions greater than 12 inches in length, reinforcing plates shall be used to reinforce the housings at the point of attachment.**” to the end of the paragraph.

718.08 Controller Cabinet Revise this subsection by replacing the paragraph beginning with “The cabinet shall be supplied with LED light panels...” on or about page 7-66 with **“The cabinet shall be supplied with white LED light panels which shall automatically illuminate via a door open switch whenever one of the four main cabinet doors are opened for the ground mount cabinet or two main doors for the side of pole cabinet. The ground mounted cabinet shall contain four LED light panels per side totaling eight panels for the cabinet; one panel each at the top and bottom portion of the front side and back side on the Control side and Power/Auxiliary side of the cabinet. Each light panel shall produce a minimum of 250 lumens for a total minimum lumen output of 2000 lumens with all eight panels illuminated. The minimum output per side would be 1000 lumens. The LED panels shall be protected by a clear shatterproof shield. The side of pole mounted cabinet shall contain four light panels; one at the top of the rack assembly and one at the bottom rack assembly on each side of the cabinet.**

A second door open status switch per door shall activate a controller input to log a report event that one of the doors was opened. All door open status switches shall be connected to the same controller input. For the ground mount cabinet, there shall be two switches on each of the four main doors. For the side-of-pole mount cabinet, there shall be two switches on each of the two main doors.”

Revise this subsection by replacing the paragraph beginning with “The cabinet shall be supplied with a generator panel ...” on or about page 7-68 with:

“The cabinet shall be supplied with a generator panel. The generator panel shall consist of a manual transfer switch and a twist-lock connector for generator hookup. The transfer switch knob and twist-lock connector shall be located inside a stainless steel enclosure with a separate lockable door accessed with a Corbin #2 key. The unit shall be mounted on the left, exterior of the control side wall of the ground mount cabinet a minimum of 36” above the surrounding grade and on the lower left side of the pole mounted cabinet. The generator transfer switch shall be a Reliance C30A1N Signa Series or approved equal. “

Revise this subsection by removing the following from the paragraph beginning with “The ground mounted cabinet shall be supplied and installed with an electric service meter socket trim and electrical service disconnect switch ...” on or about page 7-69: **“(removed: thus preventing that space from being used either by equipment supplied as part of the project, or future equipment that would be installed in the rack system. Joe indicated that he would add this language to the detail so it is covered.)”**.

Revise this subsection by replacing the following in the paragraph beginning with “The Contractor shall reconfigure the default user name...” on or around page 7-70; “MaineDOT IT” with **“MaineDOT Traffic Division”**.

In the paragraph beginning with “Tests shall be conducted by the contractor...” on or around page 7-73, amend this subsection by removing **“in the state of Maine and”** after “The facility shall be”.

Amend this Section by adding the following subsection:

718.13 Field Monitoring Unit (FMU) This item of work shall conform to this specification. This item shall consist of furnishing and installing a Field Monitoring Unit (FMU) and software, as well as all needed accessories required for a full and complete installation, including but not limited to power adapters, Ethernet cables, and interface cables, as described herein.

Where applicable, communications from MaineDOT's cloud-based Central Management System (CMS) to the on-street traffic signal controllers shall be made through fiber optic interconnect cable connected back to existing internet connections and/or the Field Monitoring Unit (FMU). The Contractor shall furnish and install all materials necessary for a complete and operational fiber optic interconnection to all project intersections as shown on the plans. All connections to the CMS cloud-based system shall be via a secure VPN network.

The FMU shall be the only remote connection device used by isolated intersections to connect to the cloud-based system. All connections shall be encrypted VPN tunnels. The Contractor shall coordinate all configuration settings with MaineDOT IT and the Engineer.

The FMU central web based interface shall be a separate element from the CMS.

MATERIALS: The materials for this work shall conform to the following requirements:

1. The work under this item specifies the requirements for the FMU. The FMU shall operate independent of the brand/type of intersection controller deployed in the ATC traffic cabinet.
2. The FMU shall conform to the following requirements:
 - 2.1 The FMU shall function correctly between -34 degrees C and +74 degrees C.
 - 2.2 The FMU shall be provided with appropriately rated connectors that allows the FMU to be exchanged by unplugging connectors, without tools.
 - 2.3 The FMU shall monitor and log all ATC Controller and ATC cabinet faults and or alarms.
 - 2.4 The FMU shall be wired directly to the ATC cabinet.
 - 2.5 The FMU shall have an internal cellular modem running at 4G LTE.
 - 2.5.1 The Cellular modem shall be designed to be replaced / upgraded to 5G service when available.
 - 2.6 The FMU shall incorporate an integrated GPS and cell modem.
 - 2.7 The configuration of the FMU shall be accomplished by accessing the internal web server with a browser. It shall be possible to configure the FMU without any special software.
 - 2.8 The FMU shall be powered via a standard 120V input power.

- 2.9 The FMU shall allow for the routing of the controller configuration packets to and from the controller (either by Ethernet or serial communications) for any type of controller utilized by the MaineDOT. In this way it shall be possible to configure the controller and utilize the controller specific software to interrogate the controller, and the FMU shall provide the communications pipe which allows this to be accomplished.
- 2.10 The FMU shall, within the size limitations above, include a battery and battery charging/monitoring circuit, to allow the FMU to function correctly even when all power to the intersection has failed. The battery shall continue to power the FMU for a minimum of 5 hours after all power has failed to the intersection.
- 2.11 The FMU shall incorporate an integrated GPS which will allow the FMU to geo-locate itself on the FMU management software map, without configuration.
- 2.12 The FMU shall operate without requiring a static IP address. The only configuration required at the FMU is to enter the URL of where the FMU management software is hosted.
- 2.13 In the event that the cell service is interrupted or is not available, the FMU shall store any events that occur in internal memory and forward these events automatically to the FMU management software when the cell service is restored. In this way, a complete record of events at the device can be maintained even if cell service is interrupted for a period. The system will store 5000 events.
- 2.14 The FMU shall utilize HTTP and HTTPS protocols, and XML data structures, for communication with the FMU management software. In this way the data will be open for future expansion and competition. The use of secret proprietary protocols is not permitted.
- 2.15 The FMU shall include Ethernet communications via an Ethernet Port with RJ45 connector.
- 2.16 The FMU shall include weather proof antennas.

3. Map Display FMU Management Software

- 3.1 The FMU shall include a scrollable, zoomable map display, with the intersections and other monitored devices shown as representative icons on the map. The map shall include the ability to see the intersections using Google Streetview.
- 3.2 The alarm status of the intersection shall be clearly indicated on the icon on the map, so that the user can see at a glance which intersections are in alarm.
- 3.3 The map display shall also include a list of intersections, with the number and priority of alarms indicated on the list. Intersections in high priority alarm shall be moved to the top

of the list, followed by medium priority, low priority and then finally by intersections not in alarm.

- 3.4 The icons shall change to be able to clearly indicate if an intersection is offline.
- 3.5 Clicking on the icon on the map shall expose a box with the current parameters of the intersection shown.
- 3.6 The default map display position and zoom shall be configurable by user, so that the user's view will default to show the intersections that the user is responsible for managing.
- 3.7 The map view shall have the ability to show Google traffic overlays on the map.

4. Intersection Detail Display FMU Management Software

- 4.1 It shall be possible to drill down, either from the map icon or from the list, to a device level detail for the intersection, which as a minimum shall display the following parameters:
 - 4.1.1 The alarm status, with priority indicated, and a text description of the alarm (if an alarm is present for this device).
 - 4.1.2 The time since the last communication with the device
 - 4.1.3 The following parameters (real time now values, minimum for the day values, maximum for the day values, and average for the day values)
 - 4.1.3.1 The AC mains voltage (value)
 - 4.1.3.2 The battery back-up voltage (value)
 - 4.1.3.3 The cabinet temperature (value)
 - 4.1.3.4 The cabinet humidity (value)
 - 4.1.3.5 The presence of AC power (OK or Fail)
 - 4.1.3.6 The flashing status of the intersection (OK or Flashing)
 - 4.1.3.7 Stop Time status (OK or Stop Time Active)
 - 4.1.3.8 The cabinet door status (Open or Closed)
 - 4.1.3.9 The intersection fan status (Fan On or Fan off)

4.1.4 It shall be possible to view graphs of each of the value parameters in graphical form, over the recent two-week period. This includes real time graphs of:

4.1.4.1 The AC mains voltage

4.1.4.2 The battery back-up voltage

4.1.4.3 The cabinet temperature

4.1.4.4 The cabinet humidity

5. Diagnostics and Log Display FMU Management Software

5.1 From the device level detail within the FMU management software, it shall be possible to drill down to get the raw data; the error logs; and the communications logs to allow a technician to fault-find problems.

5.2 It shall be possible to filter the logs by Device; by Device Type and/or by Group as well as between dates.

5.3 It shall be possible to print these selected logs to a local printer or a PDF file.

5.4 It shall be possible to export these logs to Excel on the local computer for further analysis.

6. Alarms FMU Management Software

6.1 The FMU management software shall have a comprehensive alarm generation capability

6.2 It shall be possible to configure alarms to be generated on any parameter becoming out of tolerance, including analog values, digital values and enumerated values.

6.3 Alarms shall be configurable to be of Low, High or Critical Priority.

6.4 The alarm priority shall be displayed throughout the FMU management software, on all displays, using color codes such as red-critical; yellow – high; and amber-low to indicate the priority of the alarm.

6.5 The current active alarms shall be accessible for view via an expandable window, to see which alarms are active and when the alarm occurred. The highest priority alarms shall rise to the top of the list.

7. Alerts FMU Management Software

7.1 The FMU management software shall have comprehensive alerting capability, to enable the response personnel to be notified when an abnormal situation has occurred.

- 7.2 It shall be possible to configure alerts to one or more personnel for each alarm. This will cause, as selected, an SMS and/or an email to be sent to the person when an alarm occurs.
- 7.3 The alert shall be configurable to optionally send via email and/or via SMS a message when an alarm clears.
- 7.4 The intention is that the FMU management software provides the alerts to the user in near real time. The SMS and email shall be issued within 30 seconds of the occurrence of event which results in an alert being issued.

8. **Hosting and Connectivity and Service FMU / FMU Management Software**

- 8.1 The contractor shall supply the FMU with the FMU manufacturers 10 year options for Connectivity and Service, as part of the purchase price. The Connectivity and Service agreement shall include at a minimum:
- 8.1.1 Cellular Connectivity
 - 8.1.2 No cellular overage charges
 - 8.1.3 Extended warranty on the hardware for the period of the Connectivity and Service Agreement
 - 8.1.4 Over-the-air software updates
 - 8.1.5 Over-the-air security updates
 - 8.1.6 Future Connected Vehicles Service

Section 719 SIGNING MATERIAL

719.072 Overhead Signing: Revise this subsection by replacing it in entirety with:

“Sign panels mounted to independent sign support structures and support structure components mounted to bridges passing over the highway are considered to be overhead signing. Overhead signing shall be mounted on W6 by 9 steel beams conforming to the requirements of ASTM A992/A992M, galvanized in accordance with AASHTO M 111 (ASTM A123), or the same size aluminum beams conforming to ASTM B221M, alloys and tempers of 6061-T6, 6063-T6 or 6005-T5. These components shall be horizontally spaced a maximum of 5¼ feet on center, extending from the bottom of sign panel to the top. If supplemental signs are included in the contract, these beams will extend from the bottom of the main sign panel to the top of the supplemental sign panel. The maximum distance from the edge of the sign to the center of the W6 by 9 shall not exceed approximately 3¼ feet.

On independent sign support structures, these W6 by 9 beam components shall be fastened to chords with a pair of appropriately sized U-bolts on each side of the web at each fastening

location. A similar pair of U-bolt assemblies shall be used in attaching each chord of an overhead component to upright supports. U-bolts for steel support structures shall conform to ASTM A449, Type 1. U-bolt hardware, which includes nuts, flat washers, and helical lock washers, shall be galvanized in accordance with AASHTO M 232 (ASTM A153), ASTM F2329, or ASTM B695, Class 50, Type I. Washers shall conform to the requirements of ASTM F436. The U-bolt material for aluminum support structures, or a combination of steel and aluminum structural components, shall be stainless steel conforming to the requirements of ASTM F593, alloy group 1, with a minimum yield strength of 45 ksi. Steel support structures may also utilize stainless steel hardware assemblies as an alternative to galvanized steel. Nuts shall be of the locking type with nylon inserts. Washers shall conform to the requirements of ASTM A276, Type 302. Flat washers, without helical lock washers, will be acceptable in this stainless steel assembly.

On bridge mounted structures, the fastener configurations shall be depicted in the contract documents. “

SECTION 720 STRUCTURAL SUPPORTS FOR HIGHWAY SIGNS, LUMINAIRES AND TRAFFIC SIGNALS

720.03 Steel Supports: Revise this subsection by removing the paragraph beginning with “Chord flange splice fastener” and replacing with:

“Chord flange splice fastener assemblies shall conform to ASTM A325, Type 1, and galvanized in accordance with AASHTO M 232 (ASTM A153), ASTM F2329, or ASTM B695, Class 50, Type I. Other fastener assemblies shall be as specified in Section 719.07, or as approved by the Fabrication Engineer.”

720.06 Steel H-beam: Revise this subsection by replacing it in its entirety with:

“Steel H-beam Post shall conform to the requirements of ASTM A992. All work shall conform to the applicable provisions of Section 504 – Structural Steel. Steel shall be hot-dip galvanized in accordance with AASHTO M 111 (ASTM A123). All steel hardware for use with H-beam poles shall be galvanized in accordance with AASHTO M 232 (ASTM A153), ASTM F2329, or ASTM B695, Class 50, Type I.”

720.07 Anchor Bolts: Revise this subsection by replacing it in its entirety with:

“Anchor bolts and nuts supplied for aluminum and/or steel supports shall conform to ASTM A449, Type 1, or ASTM F1554, Grade 55, both with a minimum yield strength of 55 ksi. Anchor bolts shall be supplied with 2 heavy hex nuts and 2 hardened washers and unless otherwise specified the anchor bolts shall have a 90° bend with a 6 inch minimum leg length at the lower end. The anchor bolts, nuts and hardened washers shall be galvanized in accordance with AASHTO M 232 (ASTM A153), ASTM F2329, or ASTM B695, Class 50, Type I. The bolt

shall be zinc-coated 12 inches from the exposed end, unless otherwise specified. If the anchor bolts are to be used with breakaway devices incorporating the function of a nut, for example, longitudinally grooved breakaway couplings, nuts or washers will not be required.

Alternate materials, grades, and designs may be used for anchor bolts subject to approval of the Fabrication Engineer.”

720.09 Wood Ornamental Light Standard: Revise this subsection by removing the paragraph beginning with “All bolts shall be” and replacing it with:

“All bolts shall be galvanized in accordance with AASHTO M 232 (ASTM A153), ASTM F2329, or ASTM B695, Class 50, Type I.”

720.12 Wood Sign Posts Revise the first sentence so that it reads:

“Wood sign posts shall be rectangular, straight and sound timber, cut from live growing native spruce, red pine, hemlock, cedar trees or other AWWA approved species, free from loose knots or other structurally weakening defects of importance, such as shake or holes or heart rot.”

Revise the third paragraph that starts with “When pressure treated...” so that it reads:

“All sign posts shall be pressure-treated in accordance with AASHTO M 133 and AWWA Standard U1, UC4A, Commodity Specification A: Sawn Products.”

APPENDIX A TO DIVISION 100

SECTION 1 - BIDDING PROVISIONS

A. Federally Required Certifications By signing and delivering a Bid, the Bidder certifies as provided in all certifications set forth in this Appendix A - Federal Contract Provisions Supplement including:

- Certification Regarding No Kickbacks to Procure Contract as provided on this page 1 below.
- Certification Regarding Non-collusion as provided on page 1 below.
- Certification Regarding Non-segregated Facilities as provided by FHWA Form 1273, section III set forth on page 21 below.
- "Certification Regarding Debarment, Suspension, Ineligibility and Voluntary Exclusion" as provided by FHWA Form 1273, section XI set forth on page 32 below.
- "Certification Regarding Use of Contract Funds for Lobbying" as provided by FHWA Form 1273, section XII set forth on page 35 below.

Unless otherwise provided below, the term "Bidder", for the purposes of these certifications, includes the Bidder, its principals, and the person(s) signing the Bid. Upon execution of the Contract, the Bidder (then called the Contractor) will again make all the certifications indicated in this paragraph above.

CERTIFICATION REGARDING NO KICKBACKS TO PROCURE CONTRACT Except expressly stated by the Bidder on sheets submitted with the Bid (if any), the Bidder hereby certifies, to the best of its knowledge and belief, that it has not:

(A) employed or retained for a commission, percentage, brokerage, contingent fee, or other consideration, any firm or person (other than a bona fide employee working solely for me) to solicit or secure this contract;

(B) agreed, as an express or implied condition for obtaining this contract, to employ or retain the services of any firm or person in connection with carrying out the contract, or;

(C) paid, or agreed to pay, to any firm, organization, or person (other than a bona fide employee working solely for me) any fee, contribution, donation, or consideration of any kind for, or in connection with, procuring or carrying out the contract;

By signing and submitting a Bid, the Bidder acknowledges that this certification is to be furnished to the Maine Department of Transportation and the Federal Highway Administration, U.S. Department of Transportation in connection with this contract in anticipation of federal aid highway funds and is subject to applicable state and federal laws, both criminal and civil.

CERTIFICATION REGARDING NONCOLLUSION Under penalty of perjury as provided by federal law (28 U.S.C. §1746), the Bidder hereby certifies, to the best of its knowledge and belief, that:

the Bidder has not, either directly or indirectly, entered into any agreement, participated in any collusion, or otherwise taken any action in restraint of competitive bidding in connection with the Contract.

For a related provisions, see Section 102.7.2 (C) of the Standard Specifications - "Effects of Signing and Delivery of Bids" - "Certifications", Section 3 of this Appendix A entitled "Other Federal Requirements" including section XI - "Certification Regarding Debarment, Suspension, Ineligibility, and Voluntary Exclusion" and section XII. - "Certification Regarding Use of Contract Funds for Lobbying."

B. Bid Rigging Hotline To report bid rigging activities call: **1-800-424-9071**

The U.S. Department of Transportation (DOT) operates the above toll-free "hotline" Monday through Friday, 8:00 a.m. to 5:00 p.m., eastern time. Anyone with knowledge of possible bid rigging, bidder collusion, or other fraudulent activities should use the "hotline" to report such activities.

The "hotline" is part of the DOT's continuing effort to identify and investigate highway construction contract fraud and abuse and is operated under the direction of the DOT Inspector General. All information will be treated confidentially and caller anonymity will be respected.

SECTION 2 - FEDERAL EEO AND CIVIL RIGHTS REQUIREMENTS

Unless expressly otherwise provided in the Bid Documents, the provisions contained in this Section 2 of this "Federal Contract Provisions Supplement" are hereby incorporated into the Bid Documents and Contract.

A. Nondiscrimination & Civil Rights - Title VI The Contractor and its subcontractors shall not discriminate on the basis of race, color, national origin, or sex in the performance of this Contract. The Contractor shall carry out applicable requirements of 49 CFR Part 26 in the award and administration of DOT assisted contracts. Failure by the Contractor to carry out these requirements is a material breach of this contract, which may result in the termination of this contract or such other remedy as the Department deems appropriate. The Contractor and subcontractors shall comply with Title VI of the Civil Rights Act of 1964, as amended, and with all State of Maine and other Federal Civil Rights laws.

For related provisions, see Subsection B - "Nondiscrimination and Affirmative Action - Executive Order 11246" of this Section 2 and Section 3 - Other Federal Requirements of this "Federal Contract Provisions Supplement" including section II - "Nondiscrimination" of the "Required Contract Provisions, Federal Aid Construction Contracts", FHWA-1273.

B. Nondiscrimination and Affirmative Action - Executive Order 11246 Pursuant to Executive Order 11246, which was issued by President Johnson in 1965 and amended in 1967 and 1978, this Contract provides as follows.

The Contractor shall take specific affirmative actions to ensure equal employment opportunity. The evaluation of the Contractor's compliance with these specifications shall be

based upon its efforts to achieve maximum results from its actions. The Contractor shall document these efforts fully, and shall implement affirmative action steps at least as extensive as the following:

Ensure and maintain a working environment free of harassment, intimidations, and coercion at all sites, and in all facilities at which the Contractor's employees are assigned to work. The Contractor, where possible, will assign two or more women to each construction project. The Contractor shall specifically ensure that all forepersons, superintendents, and other on-site supervisory personnel are aware of and carry out the Contractor's obligation to maintain such a working environment, with specific attention to minority or female individuals working at such sites or in such facilities.

Establish and maintain a current list of minority and female recruitment sources, provide written notification to minority and female recruitment sources and to community organizations when the Contractor or its union have employment opportunities available, and to maintain a record of the organization's responses.

Maintain a current file of the names, addresses and telephone numbers of each minority and female off-the-street applicant and minority or female referral from a union, a recruitment source or community organization and of what action was taken with respect to each such individual. If such individual was sent to the union hiring hall for referral and was not referred back to the Contractor by the union or, if referred, not employed by the Contractor, this shall be documented in the file with the reason therefore, along with whatever additional actions the Contractor may have taken.

Provide immediate written notification to the Department's Civil Rights Office when the union or unions with which the Contractor has a collective bargaining agreement has not referred to the Contractor a minority person or woman sent by the Contractor, or when the Contractor has other information that the union referral process has impeded the Design-Builder's efforts to meet its obligations.

Develop on-the-job training opportunities and/or participate in training programs for the area which expressly include minorities and women, including upgrading programs and apprenticeship and trainee programs relevant to the Contractor's employment needs, especially those programs funded or approved by the Department of Labor. The Contractor shall provide notice of these programs to the sources compiled under B above.

Disseminate the Contractor's EEO policy by providing notice of the policy to unions and training programs and requesting their cooperation in assisting the Contractor in meeting its EEO obligation; by including it in any policy manual and collective bargaining agreement; by publicizing it in the company newspaper, annual report, etc.; by specific review of the policy with all management personnel and with all minority and female employees at least once a year; and by posting the company EEO policy on bulletin boards accessible to all employees at each location where construction work is performed.

Review, at least annually, the company's EEO policy and affirmative action obligations under these specifications with all employees having any responsibility for hiring,

assignment, layoff, termination, or other employment decisions including specific review of these items with on-site supervisory personnel such as Superintendents, General Forepersons, etc., prior to the initiation of construction work at any job site. A written record shall be made and maintained identifying the time and place of these meetings, persons attending, subject matter discussed, and disposition of the subject matter.

Disseminate the Contractor's EEO policy externally by including it in any advertising in the news media, specifically including minority and female news media, and providing written notification to and discussing the Contractor's EEO policy with other Contractor's and Subcontractors with whom the Contractor does or anticipates doing business.

Direct its recruitment efforts, both orally and written to minority, female and community organizations, to schools with minority and female students and to minority and female recruitment and training organizations serving the Contractor's recruitment area and employment needs. Not later than one month prior to the date for the acceptance of applications for apprenticeship or other training by any recruitment source, the Contractor shall send written notification to organizations such as the above describing the openings, screenings, procedures, and test to be used in the selection process.

Encourage present minority and female employees to recruit other minority persons and women and, where reasonable, provide after school, summer and vacation employment to minority and female youth, both on the site and in other areas of a Contractor's workforce.

Validate all tests and other selection requirements.

Conduct, at least annually, an inventory and evaluation at least of all minority and female personnel for promotional opportunities and encourage these employees to seek or to prepare for, through appropriate training, etc., such opportunities.

Ensure that seniority practices, job classifications, work assignments and other personnel practices, do not have a discriminatory effect by continually monitoring all personnel and employment related activities to ensure that the EEO policy and the Contractor's obligations under these specifications are being carried out.

Ensure that all facilities and company activities are non segregated except that separate or single-user toilet and necessary changing facilities shall be provided to assure privacy between the sexes.

Document and maintain a record of all solicitations of offers for subcontracts from minority and female construction Contractor's and suppliers, including circulation of solicitations to minority and female Contractor associations and other business associations.

Conduct a review, at least annually, of all supervisors' adherence to and performance under the Contractor's EEO policies and affirmative action obligations.

C. Goals for Employment of Women and Minorities Per Executive Order 11246, craft tradesperson goals are 6.9% women and .5% minorities employed. However, goals may be adjusted upward at the mutual agreement of the Contractor and the Department. Calculation of these percentages shall not include On-the-Job Training Program trainees, and shall not include clerical or field clerk position employees.

For a more complete presentation of requirements for such Goals, see the federally required document "Goals for Employment of Females and Minorities" set forth in the next 6 pages below.

Start of GOALS FOR EMPLOYMENT OF FEMALE AND MINORITIES
Federally Required Contract Document

§60-4.2 Solicitations

(d) The following notice shall be included in, and shall be part of, all solicitations for offers and bids on all Federal and federally assisted construction contracts or subcontracts in excess of \$10,000 to be performed in geographical areas designated by the Director pursuant to §60-4.6 of this part (see 41 CFR 60-4.2(a)):

Notice of Requirement for Affirmative Action to Ensure Equal Opportunity (Executive Order 11246)

1. The Offeror's or bidder's attention is called to the "Equal Opportunity Clause" and the "Standard Federal Equal Employment Specifications" set forth herein.
2. The goals and timetables for minority and female participation, expressed in percentage terms for the Contractor's aggregate work force in each trade on all construction work in the covered area, are as follows:

<u>Goals for female participation in each trade</u>	6.9%
---	------

Goals for minority participation for each trade

Maine

001 Bangor, ME	0.8%
----------------	------

Non-SMSA Counties (Aroostook, Hancock, Penobscot, Piscataquis, Waldo, Washington)

002 Portland-Lewiston, ME

SMSA Counties: 4243 Lewiston-Auburn, ME (Androscoggin)	0.5%
---	------

6403 Portland, ME (Cumberland, Sagadahoc)	0.6%
--	------

Non-SMSA Counties: (Franklin, Kennebec, Knox, Lincoln, Oxford, Somerset, York)	0.5%
---	------

These goals are applicable to all the Contractor's construction work (whether or not it is Federal or federally assisted) performed in the covered area. If the contractor performs construction work in a geographical area located outside of the covered area, it shall apply the goals established for such geographical area where the work is actually performed. With regard to this second area, the contractor also is subject to the goals for both its federally involved and non federally involved construction.

The contractor's compliance with the Executive Order and the regulations in 41 CFR Part 60-4 shall be based on its implementation of the Equal Opportunity Clause, specific affirmative action obligations required by the specifications set forth in 41 CFR 60-4.3(a), and its efforts to meet the goals. The hours of minority and female employment and training must be substantially uniform throughout the length of the contract, and in each trade, and the contractor shall make a good faith effort to employ minorities and women evenly on each of its projects. The transfer of minority or female employees or trainees from Contractor to Contractor or from project to project for the sole purpose of meeting the Contractor's goals shall be in violation of the contract, the Executive Order and the regulations in 41 CFR Part 60-4. Compliance with the goals will be measured against the total work hours performed.

3. The Contractor shall provide written notification to the Director of the Office of Federal Contract Compliance Programs within 10 working days of award of any construction subcontract in excess of \$10,000 at any tier for construction work under the contract resulting from this solicitation. The notification shall list the name, address and telephone number of the subcontractor, employer identification number of the subcontractor, estimated dollar amount of the subcontract; estimated started and completion dates of the subcontract; and the geographical area in which the subcontract is to be performed.

4. As used in this Notice, and in the Contract resulting from this solicitation, the "covered area" is (insert description of the geographical areas where the contract is to be performed giving the state, county and city, if any).

STANDARD FEDERAL EQUAL EMPLOYMENT OPPORTUNITY CONSTRUCTION
CONTRACT SPECIFICATIONS (EXECUTIVE ORDER 11246)

1. As used in these specifications:

- a. "Covered area" means the geographical area described in the solicitation from which this contract resulted;
- b. "Director" means Director, Office of Federal Contract Compliance Programs, United States Department of Labor, or any person to whom the Director delegates authority;
- c. "Employer identification number" means the Federal Social Security number used on the Employer's Quarterly Federal Tax Return, U.S. Treasury Department form 941;
- d. "Minority" includes:
 - (i) Black (all persons having origins in any of the Black African racial groups not of Hispanic origin);

- (ii) Hispanic (all persons of Mexican, Puerto Rican, Cuban, Central or South American or other Spanish Culture or origin, regardless of race);
 - (iii) Asian and Pacific Islander (all persons having origins in any of the original peoples of the Far East, Southeast Asia, the Indian Subcontinent, or the Pacific Islands); and
 - (iv) American Indian or Alaskan Native (all persons having origins in any of the original peoples of the North America and maintaining identifiable tribal affiliations through membership and participation or community identification).
2. Whenever the Contractor, or any subcontractor at any tier, subcontracts a portion of the work involving any construction trade, it shall physically include in each subcontract in excess of \$10,000 the provisions of these specifications and the Notice which contains the applicable goals for minority and female participation and which is set forth in the solicitations from which this contract resulted.
 3. If the contractor, is participating (pursuant to 41 CFR 60-4.5) in a Hometown Plan approved by the U.S. Department of Labor in the covered area either individually or through an association, its affirmative action obligations on all work in the Plan area (including goals and timetables) shall be in accordance with that Plan for those trades which have unions participating in the Plan. Contractors must be able to demonstrate their participation in and compliance with the provisions of any such Hometown Plan. Each Contractor or Subcontractor participating in an approved Plan is individually required to comply with its obligations under the EEO clause, and to make a good faith effort to achieve each goal under the Plan in each trade in which it has employees. The overall good faith performance by other Contractors for Subcontractors toward a goal in an approved Plan does not excuse any covered Contractor's or Subcontractor's failure to take good faith efforts to achieve the Plan goals and timetables.
 4. The Contractor shall implement the specific affirmative action standards provided in paragraphs 7 a. through p. of these specifications. The goals set forth in the solicitation from which this contract resulted are expressed as percentages of the total hours of employment and training of minority and female utilization the Contractor should reasonably be able to achieve in each construction trade in which it has employees in contractors performing construction work in geographical areas where they do not have a Federal or federally assisted construction contract shall apply the minority and female goals established for the geographical areas where the work is being performed. Goals are published periodically in the Federal Register in notice form and such notices may be obtained from any Office of Federal Contract Compliance Programs office or from Federal procurement contracting officers. The Contractor is expected to make substantially uniform progress in meeting its goals in each craft during the period specific.
 5. Neither the provisions of any collective bargaining agreement, nor the failure by a union with whom the Contractor has a collective bargaining agreement, to refer either minorities or women shall excuse the Contractor's obligations under these specifications, Executive Order 11246, or the regulations promulgated pursuant, thereto.
 6. In order for the non working training hours of apprentices and trainees to be counted in meeting the goals, such apprentices and trainees must be employed by the Contractor during the training period, and the Contractor must have made a commitment to employ the

apprentices and trainees at the completion of their training, subject to the availability of employment opportunities. Trainees must be trained pursuant to training programs approved by the U.S. Department of Labor.

7. The Contractor shall take specific affirmative actions to ensure equal employment opportunity. The evaluation of the Contractor's compliance with these specifications shall be based upon its effort to achieve maximum results from its actions. The Contractor shall document these efforts fully, and shall implement affirmative action steps at least as expensive as the following:
 - a. Ensure and maintain a working environment free of harassment, intimidation, coercion at all sites, and in all facilities at which the Contractor's employees are assigned to work. The Contractor, when possible, will assign two or more women to each construction project. The Contractor shall specifically ensure that all foremen, superintendents, and other on-site supervisory personnel are aware of and carry out the Contractor's obligation to maintain such a working environment, with specific attention to minority or female individuals working at such sites or in such facilities.
 - b. Establish and maintain a current list of minority and female recruitment sources provide written notification to minority and female recruitment sources and to community organizations when the Contractor or its unions have employment opportunities available, and maintain a record of the organization's responses.
 - c. Maintain a current file of the names, addresses and telephone numbers of each minority and female off-the-street applicant and minority or female referral from a union, a recruitment sources or community organization and of what action was taken with respect to each such individual. If such individual was sent to the union hiring hall for referral and was not referred back to the Contractor by the union or, if referred, not employed by the Contractor, this shall be documented in the file with the reason therefore, along with whatever additional actions the Contractor may have taken.
 - d. Provide immediate written notification to the Director when the union or unions with which the Contractor has a collective bargaining agreement has not referred to the Contractor a minority person or woman sent by the Contractor, or when the Contractor has other information that the union referral process has impeded the Contractor's efforts to meet its obligations.
 - e. Develop on-the-job training opportunities and/or participate in training programs for the area which expressly include minorities and women, including upgrading programs and apprenticeship and trainee programs relevant to the Contractor's employment needs, especially those programs funded or approved by the Department of Labor. The Contractor shall provide notice of these programs to the sources complied under 7b above.
 - f. Disseminate the Contractor's EEO policy by providing notice of the policy to unions and training programs and requesting their cooperation in assisting the Contractor in meeting its EEO obligations; by including in any policy manual and collective bargaining agreement; by publicizing it in the company newspaper, annual report, etc.; by specific

review of the policy with all management personnel and with all minority and female employees at least once a year; and by posting the company EEO policy on bulletin boards accessible to all employees at each location where construction work is performed.

- g. Review, at least annually, the company's EEO policy and affirmative action obligations under these specifications with all employees having any responsibility for hiring, assignment, layoff, termination or other employment decisions including specific review of these items with on-site supervisory personnel such as Superintendents, General Foremen, etc., prior to the initiation of construction work at any job site. A written record shall be made and maintained identifying the time and place of these meetings, persons attending, subject matter discussed, and disposition of the subject matter.
- h. Disseminate the Contractor's EEO policy externally by including it in any advertising in the news media, specifically including minority and female news media, and providing written notification to and discussing the Contractor's EEO policy with other Contractors and Subcontractors with whom the Contractor does or anticipates doing business.
- i. Direct its recruitment, efforts, both oral and written, to minority, female and community organizations, to schools with minority and female students and to minority and female recruitment and training organizations serving the Contractor's recruitment area and employment needs. Not later than one month other training by any recruitment source, the Contractor shall send written notification to organizations such as the above, describing prior to the date for the acceptance of applications for apprenticeship or the openings, screening procedures, and tests to be used in the selection process.
- j. Encourage present minority and female employees to recruit other minority persons and women and, where reasonable, provide after school, summer and vacation employment to minority and female youth both on site and in other areas of a Contractor's work force.
- k. Validate all tests and other selection requirements where there is an obligation to do so under 41 CFR Part 60-3.
- l. Conduct, at least annually, an inventory and evaluation at least of all minority and female personnel for promotional opportunities and encourage these employees to seek or to prepare for, through appropriate training, etc., such opportunities.
- m. Ensure that seniority practices, job classifications, work assignments and other personnel practices, do not have a discriminatory effect by continually monitoring all personnel and employment related activities to ensure that the EEO policy and the Contractor's obligations under these specifications are being carried out.
- n. Ensure that all facilities and company activities are non segregated except that separate or single-user toilet and necessary changing facilities shall be provided to assure privacy between the sexes.
- o. Document and maintain a record of all solicitations of offers for subcontracts from minority and female construction contractors and suppliers, including circulation of

solicitation to minority and female contractor associations and other business associations.

- p. Conduct a review, at least annually, of all supervisor's adherence to and performance under the Contractor's EEO policies and affirmative action obligations.
8. Contractors are encouraged to participate in voluntary associations which assist in fulfilling one or more of their affirmative action obligations (7 a through p.). The efforts of a contractor association, joint contractor-union, contractor-community, or other similar group of which the contractor is a member and participant, may be asserted as fulfilling any one or more of its obligations under 7 a through p. of these specifications provided that the contractor actively participates in the group, makes every effort to assure that the group has a positive impact on the employment of minorities and women in the industry, ensures that the concrete benefits of the program and reflected in the Contractor's minority and female work force participation, makes a good faith effort to meet its individual goals and timetables, and can provide access to documentation which demonstrates the effectiveness of actions take on behalf of the Contractor. The obligation to comply, however, is the Contractor's and failure of such a group to fulfill an obligation shall not be a defense for the Contractor's noncompliance.
9. A single goal for minorities and a separate single goal for women have been established. The Contractor, however, is required to provide equal employment opportunity and to take affirmative action for all minority groups, both male and female, and all women, both minority and non-minority. Consequently, the Contractor may be in violation of the Executive Order if a particular group is employed in a substantially disparate manner (for example, specific minority group of women is underutilized.)
10. The Contractor shall not use the goals and timetables or affirmative action even through the Contractor has achieved its goals for women generally, the Contractor may be in violation of the Executive Order if standards to discriminate against any person because of race, color, religion, sex, or national origin.
11. The Contractor shall not enter into any Subcontract with any person or firm debarred from Government contracts pursuant to Executive Order 11246.
12. The Contractor shall carry out such sanctions and penalties for violation of these specifications and of the Equal Opportunity Clause, including suspension, termination and cancellation of existing subcontracts as may be imposed or ordered pursuant to Executive Order 11246, as amended, and its implementation regulations by the Office of Federal Contract Compliance Programs. Any Contractor who fails to carry out such sanctions and penalties shall be in violation of these specifications and Executive Order 11246, as amended.
13. The Contractor, in fulfilling its obligations under these specifications, shall implement specific affirmative action steps, at least as extensive as those standards prescribed in paragraph 7 of these specifications, so as to achieve maximum results from its efforts to ensure equal employment opportunity. If the Contractor fails to comply with the

requirements of the Executive Order, the implementing regulations, or these specifications, the Director shall proceed in accordance with 41 CFR 60-4.6.

14. The Contractor shall designate a responsible official to monitor all employment related activity to ensure that the company EEO policy is being carried out, to submit reports relating to the provisions hereof as may be required by the Government and to keep records. Records shall at least include for each employee the name, address, telephone numbers, construction trade, union affiliation if any, employee identification number when assigned, social security number, race, sex, status (e.g. mechanic, apprentice, trainee, helper, or laborer), dates of changes in status, hours worked per week in the indicated trade, rate of pay, and location at which the work was performed. Records be maintained in an easily understandable and retrievable form; however, to the degree that existing records satisfy this requirement, contractors shall not be required to maintain separate records.
15. Nothing herein provided shall be construed as a limitation upon the application of other laws which establish different standards of compliance or upon the application of requirements for the hiring of local or other area residents (e.g., those under the Public Works Employment Act of 1977 and the Community Development Block Grant Program).

End of GOALS FOR EMPLOYMENT OF FEMALES AND MINORITIES
Federally Required Contract Document

D. Section '**D Disadvantaged Business Enterprise (DBE) Requirements**' is removed in its entirety. The DBE material is in:

Section 105.10 EQUAL OPPORTUNITY AND CIVIL RIGHTS.

SECTION 3 - OTHER FEDERAL REQUIREMENTS

Unless expressly otherwise provided in the Bid Documents, the provisions contained in this Section 3 of this "Federal Contract Provisions Supplement" are hereby incorporated into the Bid Documents and Contract.

A. Buy America

If the cost of products purchased for permanent use in this project which are manufactured of steel, iron or the application of any coating to products of these materials exceeds 0.1 percent of the contract amount, or \$2,500.00, whichever is greater, the products shall have been manufactured and the coating applied in the United States. The coating materials are not subject to this clause, only the application of the coating. In computing that amount, only the cost of the product and coating application cost will be included.

Ore, for the manufacture of steel or iron, may be from outside the United States; however, all other manufacturing processes of steel or iron must be in the United States to qualify as having been manufactured in the United States.

United States includes the 50 United States and any place subject to the jurisdiction thereof.

Products of steel include, but are not limited to, such products as structural steel, piles, guardrail, steel culverts, reinforcing steel, structural plate and steel supports for signs, luminaries and signals.

Products of iron include, but are not limited to, such products as cast iron grates.

Application of coatings include, but are not limited to, such applications as epoxy, galvanized and paint.

To assure compliance with this section, the Contractor shall submit a certification letter on its letterhead to the Department stating the following:

“This is to certify that products made of steel, iron or the application of any coating to products of these materials whose costs are in excess of \$2,500.00 or 0.1 percent of the original contract amount, whichever is greater, were manufactured and the coating, if one was required, was applied in the United States.”

B. Materials

a. Convict Produced Materials References: 23 U.S.C. 114(b)(2), 23 CFR 635.417

Applicability: FHWA's prohibition against the use of convict material only applies to Federal-aid highways. Materials produced after July 1, 1991, by convict labor may only be incorporated in a Federal-aid highway construction project if: 1) such materials have been produced by convicts who are on parole, supervised release, or probation from a prison; or 2) such material has been produced in a qualified prison facility, e.g., prison industry, with the amount produced during any 12-month period, for use in Federal-aid projects, not exceeding the amount produced, for such use, during the 12-month period ending July 1, 1987.

Materials obtained from prison facilities (e.g., prison industries) are subject to the same requirements for Federal-aid participation that are imposed upon materials acquired from other sources. Materials manufactured or produced by convict labor will be given no preferential treatment.

The preferred method of obtaining materials for a project is through normal contracting procedures which require the contractor to furnish all materials to be incorporated in the work. The contractor selects the source, public or private, from which the materials are to be obtained (23 CFR 635.407). Prison industries are prohibited from bidding on projects directly (23 CFR 635.112e), but may act as material supplier to construction contractors.

Prison materials may also be approved as State-furnished material. However, since public agencies may not bid in competition with private firms, direct acquisition of materials from a prison industry for use as State-furnished material is subject to a public interest finding with the Division Administrator's concurrence (23 CFR 635.407d). Selection of materials produced by convict labor as State-furnished materials for mandatory use should be cleared prior to the submittal of the Plans Specifications & Estimates (PS&E).

b. Patented/Proprietary Products References: 23 U.S.C. 112, 23 CFR 635.411

FHWA will not participate, directly or indirectly, in payment for any premium or royalty on any patented or proprietary material, specification, or process specifically set forth in the plans and specifications for a project, unless:

- the item is purchased or obtained through competitive bidding with equally suitable unpatented items,
- the STA certifies either that the proprietary or patented item is essential for synchronization with the existing highway facilities or that no equally suitable alternative exists, or
- the item is used for research or for a special type of construction on relatively short sections of road for experimental purposes. States should follow FHWA's procedures for "Construction Projects Incorporating Experimental Features" ([expermnt.htm](#)) for the submittal of work plans and evaluations.

The primary purpose of the policy is to have competition in selection of materials and allow for development of new materials and products. The policy further permits materials and products that are judged equal may be bid under generic specifications. If only patented or proprietary products are acceptable, they shall be bid as alternatives with all, or at least a reasonable number of, acceptable materials or products listed; and the Division Administrator may approve a single source if it can be found that its utilization is in the public interest.

Trade names are generally the key to identifying patented or proprietary materials. Trade name examples include 3M, Corten, etc. Generally, products identified by their brand or trade name are not to be specified without an "or equal" phrase, and, if trade names are used, all, or at least a reasonable number of acceptable "equal" materials or products should be listed. The licensing of several suppliers to produce a product does not change the fact that it is a single product and should not be specified to the exclusion of other equally suitable products.

c. State Preference References: 23 U.S.C. 112, 23 CFR 635.409

Materials produced within Maine shall not be favored to the exclusion of comparable materials produced outside of Maine. State preference clauses give particular advantage to the designated source and thus restrict competition. Therefore, State preference provisions shall not be used on any Federal-aid construction projects.

This policy also applies to State preference actions against materials of foreign origin, except as otherwise permitted by Federal law. Thus, States cannot give preference to in-State material sources over foreign material sources. Under the Buy America provisions, the States are permitted to expand the Buy America restrictions provided that the STA is legally authorized under State law to impose more stringent requirements.

d. State Owned/Furnished/Designated Materials References: 23 U.S.C. 112, 23 CFR 635.407

Current FHWA policy requires that the contractor must furnish all materials to be incorporated in the work, and the contractor shall be permitted to select the sources from which the materials are to be obtained. Exceptions to this requirement may be made when there is a definite finding, by MaineDOT and concurred in by Federal Highway Administration's (FHWA) Division Administrator, that it is in the public interest to require the contractor to use materials furnished by the MaineDOT or from sources designated by MaineDOT. The exception policy can best be understood by separating State-furnished materials into the categories of manufactured materials and local natural materials.

Manufactured Materials When the use of State-furnished manufactured materials is approved based on a public interest finding, such use must be made mandatory. The optional use of State-furnished manufactured materials is in violation of our policy prohibiting public agencies from competing with private firms. Manufactured materials to be furnished by MaineDOT must be acquired through competitive bidding, unless there is a public interest finding for another method, and concurred in by FHWA's Division Administrator.

Local Natural Materials When MaineDOT owns or controls a local natural materials source such as a borrow pit or a stockpile of salvaged pavement material, etc., the materials may be designated for either optional or mandatory use; however, mandatory use will require a public interest finding (PIF) and FHWA's Division Administrator's concurrence.

In order to permit prospective bidders to properly prepare their bids, the location, cost, and any conditions to be met for obtaining materials that are made available to the contractor shall be stated in the bidding documents.

Mandatory Disposal Sites Normally, the disposal site for surplus excavated materials is to be of the contractor's choosing; although, an optional site(s) may be shown in the contract provisions. A mandatory site shall be specified when there is a finding by MaineDOT, with the concurrence of the Division Administrator, that such placement is the most economical or that the environment would be substantially enhanced without excessive cost. Discussion of the mandatory use of a disposal site in the environmental document may serve as the basis for the public interest finding.

Summarizing FHWA policy for the mandatory use of borrow or disposal sites:

- mandatory use of either requires a public interest finding and FHWA's Division Administrator's concurrence,
- mandatory use of either may be based on environmental consideration where the environment will be substantially enhanced without excessive additional cost, and
- where the use is based on environmental considerations, the discussion in the environmental document may be used as the basis for the public interest finding.

Factors to justify a public interest finding should include such items as cost effectiveness, system integrity, and local shortages of material.

C. Standard FHWA Contract Provisions - FHWA 1273

Unless expressly otherwise provided in the Bid Documents, the following “Required Contract Provisions, Federal Aid Construction Contracts”, FHWA-1273, are hereby incorporated into the Bid Documents and Contract.

Cargo Preference Act : Contractor and Subcontractor Clauses. “Use of United States-flag vessels: The contractor agrees—“(1) To utilize privately owned United States-flag commercial vessels to ship at least 50 percent of the gross tonnage (computed separately for dry bulk carriers, dry cargo liners, and tankers) involved, whenever shipping any equipment, material, or commodities pursuant to this contract, to the extent such vessels are available at fair and reasonable rates for United States-flag commercial vessels.”(2) To furnish within 20 days following the date of loading for shipments originating within the United States or within 30 working days following the date of loading for shipments originating outside the United States, a legible copy of a rated, ‘on-board’ commercial ocean bill-of-lading in English for each shipment of cargo described in paragraph (1) of this section to both the Contracting Officer (through the prime contractor in the case of subcontractor bills-of-lading) and to the Division of National Cargo, Office of Market Development, Maritime Administration, Washington, DC 20590.”(3) To insert the substance of the provisions of this clause in all subcontracts issued pursuant to this contract.”(Reorganization Plans No. 21 of 1950 (64 Stat. 1273) and No. 7 of 1961 (75 Stat. 840) as amended by Pub. L. 91-469 (84 Stat. 1036) and Department of Commerce Organization Order 10-8 (38 FR 19707, July 23, 1973)) [42 FR 57126, Nov. 1, 1977]

The Cargo Preference Act requirements apply to materials or equipment that are acquired for a specific Federal-aid highway project. In general, the requirements are not applicable to goods or materials that come into inventories independent of an FHWA funded-contract. For example, the requirements would not apply to shipments of Portland cement, asphalt cement, or aggregates, as industry suppliers and contractors use these materials to replenish existing inventories. In general, most of the materials used for highway construction originate from existing inventories and are not acquired solely for a specific Federal-aid project. However, if materials or equipment are acquired solely for a Federal-aid project, then the Cargo Preference Act requirements apply.”

Start of FHWA 1273 REQUIRED CONTRACT PROVISIONS
FEDERAL-AID CONSTRUCTION CONTRACTS (As revised through October 23, 2023)

**REQUIRED CONTRACT PROVISIONS
FEDERAL-AID CONSTRUCTION CONTRACTS**

- I. General
- II. Nondiscrimination
- III. Non-segregated Facilities
- IV. Davis-Bacon and Related Act Provisions
- V. Contract Work Hours and Safety Standards Act Provisions
- VI. Subletting or Assigning the Contract
- VII. Safety: Accident Prevention
- VIII. False Statements Concerning Highway Projects
- IX. Implementation of Clean Air Act and Federal Water Pollution Control Act
- X. Certification Regarding Debarment, Suspension, Ineligibility and Voluntary Exclusion
- XI. Certification Regarding Use of Contract Funds for Lobbying
- XII. Use of United States-Flag Vessels:

ATTACHMENTS

A. Employment and Materials Preference for Appalachian Development Highway System or Appalachian Local Access Road Contracts (included in Appalachian contracts only)

I. GENERAL

1. Form FHWA-1273 must be physically incorporated in each construction contract funded under title 23, United States Code, as required in 23 CFR 633.102(b) (excluding emergency contracts solely intended for debris removal). The contractor (or subcontractor) must insert this form in each subcontract and further require its inclusion in all lower tier subcontracts (excluding purchase orders, rental agreements and other agreements for supplies or services). 23 CFR 633.102(e).

The applicable requirements of Form FHWA-1273 are incorporated by reference for work done under any purchase order, rental agreement or agreement for other services. The prime contractor shall be responsible for compliance by any subcontractor, lower-tier subcontractor or service provider. 23 CFR 633.102(e).

Form FHWA-1273 must be included in all Federal-aid design-build contracts, in all subcontracts and in lower tier subcontracts (excluding subcontracts for design services, purchase orders, rental agreements and other agreements for supplies or services) in accordance with 23 CFR 633.102. The design-builder shall be responsible for compliance by any subcontractor, lower-tier subcontractor or service provider.

Contracting agencies may reference Form FHWA-1273 in solicitation-for-bids or request-for-proposals documents, however, the Form FHWA-1273 must be physically incorporated (not referenced) in all contracts, subcontracts and lower-tier subcontracts (excluding purchase orders, rental agreements and other agreements for supplies or services related to a construction contract). 23 CFR 633.102(b).

2. Subject to the applicability criteria noted in the following sections, these contract provisions shall apply to all work

performed on the contract by the contractor's own organization and with the assistance of workers under the contractor's immediate superintendence and to all work performed on the contract by piecework, station work, or by subcontract. 23 CFR 633.102(d).

3. A breach of any of the stipulations contained in these Required Contract Provisions may be sufficient grounds for withholding of progress payments, withholding of final payment, termination of the contract, suspension / debarment or any other action determined to be appropriate by the contracting agency and FHWA.

4. Selection of Labor: During the performance of this contract, the contractor shall not use convict labor for any purpose within the limits of a construction project on a Federal-aid highway unless it is labor performed by convicts who are on parole, supervised release, or probation. 23 U.S.C. 114(b). The term Federal-aid highway does not include roadways functionally classified as local roads or rural minor collectors. 23 U.S.C. 101(a).

II. NONDISCRIMINATION (23 CFR 230.107(a); 23 CFR Part 230, Subpart A, Appendix A; EO 11246)

The provisions of this section related to 23 CFR Part 230, Subpart A, Appendix A are applicable to all Federal-aid construction contracts and to all related construction subcontracts of \$10,000 or more. The provisions of 23 CFR Part 230 are not applicable to material supply, engineering, or architectural service contracts.

In addition, the contractor and all subcontractors must comply with the following policies: Executive Order 11246, 41 CFR Part 60, 29 CFR Parts 1625-1627, 23 U.S.C. 140, Section 504 of the Rehabilitation Act of 1973, as amended (29 U.S.C. 794), Title VI of the Civil Rights Act of 1964, as amended (42 U.S.C. 2000d et seq.), and related regulations including 49 CFR Parts 21, 26, and 27; and 23 CFR Parts 200, 230, and 633.

The contractor and all subcontractors must comply with: the requirements of the Equal Opportunity Clause in 41 CFR 60-1.4(b) and, for all construction contracts exceeding \$10,000, the Standard Federal Equal Employment Opportunity Construction Contract Specifications in 41 CFR 60-4.3.

Note: The U.S. Department of Labor has exclusive authority to determine compliance with Executive Order 11246 and the policies of the Secretary of Labor including 41 CFR Part 60, and 29 CFR Parts 1625-1627. The contracting agency and the FHWA have the authority and the responsibility to ensure compliance with 23 U.S.C. 140, Section 504 of the Rehabilitation Act of 1973, as amended (29 U.S.C. 794), and Title VI of the Civil Rights Act of 1964, as amended (42 U.S.C. 2000d et seq.), and related regulations including 49 CFR Parts 21, 26, and 27; and 23 CFR Parts 200, 230, and 633.

The following provision is adopted from 23 CFR Part 230, Subpart A, Appendix A, with appropriate revisions to conform to the U.S. Department of Labor (US DOL) and FHWA requirements.

1. Equal Employment Opportunity: Equal Employment Opportunity (EEO) requirements not to discriminate and to take affirmative action to assure equal opportunity as set forth under laws, executive orders, rules, regulations (see 28 CFR Part 35, 29 CFR Part 1630, 29 CFR Parts 1625-1627, 41 CFR Part 60 and 49 CFR Part 27) and orders of the Secretary of Labor as modified by the provisions prescribed herein, and imposed pursuant to 23 U.S.C. 140, shall constitute the EEO and specific affirmative action standards for the contractor's project activities under this contract. The provisions of the Americans with Disabilities Act of 1990 (42 U.S.C. 12101 et seq.) set forth under 28 CFR Part 35 and 29 CFR Part 1630 are incorporated by reference in this contract. In the execution of this contract, the contractor agrees to comply with the following minimum specific requirement activities of EEO:

a. The contractor will work with the contracting agency and the Federal Government to ensure that it has made every good faith effort to provide equal opportunity with respect to all of its terms and conditions of employment and in their review of activities under the contract. 23 CFR 230.409 (g)(4) & (5).

b. The contractor will accept as its operating policy the following statement:

"It is the policy of this Company to assure that applicants are employed, and that employees are treated during employment, without regard to their race, religion, sex, sexual orientation, gender identity, color, national origin, age or disability. Such action shall include: employment, upgrading, demotion, or transfer; recruitment or recruitment advertising; layoff or termination; rates of pay or other forms of compensation; and selection for training, including apprenticeship, pre-apprenticeship, and/or on-the-job training."

2. EEO Officer: The contractor will designate and make known to the contracting officers an EEO Officer who will have the responsibility for and must be capable of effectively administering and promoting an active EEO program and who must be assigned adequate authority and responsibility to do so.

3. Dissemination of Policy: All members of the contractor's staff who are authorized to hire, supervise, promote, and discharge employees, or who recommend such action or are substantially involved in such action, will be made fully cognizant of and will implement the contractor's EEO policy and contractual responsibilities to provide EEO in each grade and classification of employment. To ensure that the above agreement will be met, the following actions will be taken as a minimum:

a. Periodic meetings of supervisory and personnel office employees will be conducted before the start of work and then not less often than once every six months, at which time the contractor's EEO policy and its implementation will be reviewed and explained. The meetings will be conducted by the EEO Officer or other knowledgeable company official.

b. All new supervisory or personnel office employees will be given a thorough indoctrination by the EEO Officer, covering all major aspects of the contractor's EEO obligations within thirty days following their reporting for duty with the contractor.

c. All personnel who are engaged in direct recruitment for the project will be instructed by the EEO Officer in the contractor's procedures for locating and hiring minorities and women.

d. Notices and posters setting forth the contractor's EEO policy will be placed in areas readily accessible to employees, applicants for employment and potential employees.

e. The contractor's EEO policy and the procedures to implement such policy will be brought to the attention of employees by means of meetings, employee handbooks, or other appropriate means.

4. Recruitment: When advertising for employees, the contractor will include in all advertisements for employees the notation: "An Equal Opportunity Employer." All such advertisements will be placed in publications having a large circulation among minorities and women in the area from which the project work force would normally be derived.

a. The contractor will, unless precluded by a valid bargaining agreement, conduct systematic and direct recruitment through public and private employee referral sources likely to yield qualified minorities and women. To meet this requirement, the contractor will identify sources of potential minority group employees and establish with such identified sources procedures whereby minority and women applicants may be referred to the contractor for employment consideration.

b. In the event the contractor has a valid bargaining agreement providing for exclusive hiring hall referrals, the contractor is expected to observe the provisions of that agreement to the extent that the system meets the contractor's compliance with EEO contract provisions. Where implementation of such an agreement has the effect of discriminating against minorities or women, or obligates the contractor to do the same, such implementation violates Federal nondiscrimination provisions.

c. The contractor will encourage its present employees to refer minorities and women as applicants for employment. Information and procedures with regard to referring such applicants will be discussed with employees.

5. Personnel Actions: Wages, working conditions, and employee benefits shall be established and administered, and personnel actions of every type, including hiring, upgrading, promotion, transfer, demotion, layoff, and termination, shall be taken without regard to race, color, religion, sex, sexual orientation, gender identity, national origin, age or disability. The following procedures shall be followed:

a. The contractor will conduct periodic inspections of project sites to ensure that working conditions and employee facilities do not indicate discriminatory treatment of project site personnel.

b. The contractor will periodically evaluate the spread of wages paid within each classification to determine any evidence of discriminatory wage practices.

c. The contractor will periodically review selected personnel actions in depth to determine whether there is evidence of discrimination. Where evidence is found, the contractor will promptly take corrective action. If the review indicates that the discrimination may extend beyond the actions reviewed, such corrective action shall include all affected persons.

d. The contractor will promptly investigate all complaints of alleged discrimination made to the contractor in connection with its obligations under this contract, will attempt to resolve such complaints, and will take appropriate corrective action

within a reasonable time. If the investigation indicates that the discrimination may affect persons other than the complainant, such corrective action shall include such other persons. Upon completion of each investigation, the contractor will inform every complainant of all of their avenues of appeal.

6. Training and Promotion:

a. The contractor will assist in locating, qualifying, and increasing the skills of minorities and women who are applicants for employment or current employees. Such efforts should be aimed at developing full journey level status employees in the type of trade or job classification involved.

b. Consistent with the contractor's work force requirements and as permissible under Federal and State regulations, the contractor shall make full use of training programs (i.e., apprenticeship and on-the-job training programs for the geographical area of contract performance). In the event a special provision for training is provided under this contract, this subparagraph will be superseded as indicated in the special provision. The contracting agency may reserve training positions for persons who receive welfare assistance in accordance with 23 U.S.C. 140(a).

c. The contractor will advise employees and applicants for employment of available training programs and entrance requirements for each.

d. The contractor will periodically review the training and promotion potential of employees who are minorities and women and will encourage eligible employees to apply for such training and promotion.

7. Unions: If the contractor relies in whole or in part upon unions as a source of employees, the contractor will use good faith efforts to obtain the cooperation of such unions to increase opportunities for minorities and women. 23 CFR 230.409. Actions by the contractor, either directly or through a contractor's association acting as agent, will include the procedures set forth below:

a. The contractor will use good faith efforts to develop, in cooperation with the unions, joint training programs aimed toward qualifying more minorities and women for membership in the unions and increasing the skills of minorities and women so that they may qualify for higher paying employment.

b. The contractor will use good faith efforts to incorporate an EEO clause into each union agreement to the end that such union will be contractually bound to refer applicants without regard to their race, color, religion, sex, sexual orientation, gender identity, national origin, age, or disability.

c. The contractor is to obtain information as to the referral practices and policies of the labor union except that to the extent such information is within the exclusive possession of the labor union and such labor union refuses to furnish such information to the contractor, the contractor shall so certify to the contracting agency and shall set forth what efforts have been made to obtain such information.

d. In the event the union is unable to provide the contractor with a reasonable flow of referrals within the time limit set forth in the collective bargaining agreement, the contractor will, through independent recruitment efforts, fill the employment vacancies without regard to race, color, religion, sex, sexual orientation, gender identity, national origin, age, or disability; making full efforts to obtain qualified and/or qualifiable minorities and women. The failure of a union to provide

sufficient referrals (even though it is obligated to provide exclusive referrals under the terms of a collective bargaining agreement) does not relieve the contractor from the requirements of this paragraph. In the event the union referral practice prevents the contractor from meeting the obligations pursuant to Executive Order 11246, as amended, and these special provisions, such contractor shall immediately notify the contracting agency.

8. Reasonable Accommodation for Applicants /

Employees with Disabilities: The contractor must be familiar with the requirements for and comply with the Americans with Disabilities Act and all rules and regulations established thereunder. Employers must provide reasonable accommodation in all employment activities unless to do so would cause an undue hardship.

9. Selection of Subcontractors, Procurement of Materials and Leasing of Equipment:

The contractor shall not discriminate on the grounds of race, color, religion, sex, sexual orientation, gender identity, national origin, age, or disability in the selection and retention of subcontractors, including procurement of materials and leases of equipment. The contractor shall take all necessary and reasonable steps to ensure nondiscrimination in the administration of this contract.

a. The contractor shall notify all potential subcontractors, suppliers, and lessors of their EEO obligations under this contract.

b. The contractor will use good faith efforts to ensure subcontractor compliance with their EEO obligations.

10. Assurances Required:

a. The requirements of 49 CFR Part 26 and the State DOT's FHWA-approved Disadvantaged Business Enterprise (DBE) program are incorporated by reference.

b. The contractor, subrecipient or subcontractor shall not discriminate on the basis of race, color, national origin, or sex in the performance of this contract. The contractor shall carry out applicable requirements of 49 CFR part 26 in the award and administration of DOT-assisted contracts. Failure by the contractor to carry out these requirements is a material breach of this contract, which may result in the termination of this contract or such other remedy as the recipient deems appropriate, which may include, but is not limited to:

- (1) Withholding monthly progress payments;
- (2) Assessing sanctions;
- (3) Liquidated damages; and/or
- (4) Disqualifying the contractor from future bidding as non-responsible.

c. The Title VI and nondiscrimination provisions of U.S. DOT Order 1050.2A at Appendixes A and E are incorporated by reference. 49 CFR Part 21.

11. Records and Reports: The contractor shall keep such records as necessary to document compliance with the EEO requirements. Such records shall be retained for a period of three years following the date of the final payment to the contractor for all contract work and shall be available at reasonable times and places for inspection by authorized representatives of the contracting agency and the FHWA.

a. The records kept by the contractor shall document the following:

(1) The number and work hours of minority and non-minority group members and women employed in each work classification on the project;

(2) The progress and efforts being made in cooperation with unions, when applicable, to increase employment opportunities for minorities and women; and

(3) The progress and efforts being made in locating, hiring, training, qualifying, and upgrading minorities and women.

b. The contractors and subcontractors will submit an annual report to the contracting agency each July for the duration of the project indicating the number of minority, women, and non-minority group employees currently engaged in each work classification required by the contract work. This information is to be reported on [Form FHWA-1391](#). The staffing data should represent the project work force on board in all or any part of the last payroll period preceding the end of July. If on-the-job training is being required by special provision, the contractor will be required to collect and report training data. The employment data should reflect the work force on board during all or any part of the last payroll period preceding the end of July.

III. NONSEGREGATED FACILITIES

This provision is applicable to all Federal-aid construction contracts and to all related construction subcontracts of more than \$10,000. 41 CFR 60-1.5.

As prescribed by 41 CFR 60-1.8, the contractor must ensure that facilities provided for employees are provided in such a manner that segregation on the basis of race, color, religion, sex, sexual orientation, gender identity, or national origin cannot result. The contractor may neither require such segregated use by written or oral policies nor tolerate such use by employee custom. The contractor's obligation extends further to ensure that its employees are not assigned to perform their services at any location under the contractor's control where the facilities are segregated. The term "facilities" includes waiting rooms, work areas, restaurants and other eating areas, time clocks, restrooms, washrooms, locker rooms and other storage or dressing areas, parking lots, drinking fountains, recreation or entertainment areas, transportation, and housing provided for employees. The contractor shall provide separate or single-user restrooms and necessary dressing or sleeping areas to assure privacy between sexes.

IV. DAVIS-BACON AND RELATED ACT PROVISIONS

This section is applicable to all Federal-aid construction projects exceeding \$2,000 and to all related subcontracts and lower-tier subcontracts (regardless of subcontract size), in accordance with 29 CFR 5.5. The requirements apply to all projects located within the right-of-way of a roadway that is functionally classified as Federal-aid highway. 23 U.S.C. 113. This excludes roadways functionally classified as local roads or rural minor collectors, which are exempt. 23 U.S.C. 101. Where applicable law requires that projects be treated as a project on a Federal-aid highway, the provisions of this subpart will apply regardless of the location of the project. Examples include: Surface Transportation Block Grant Program projects funded under 23 U.S.C. 133 [excluding recreational trails projects], the Nationally Significant Freight and Highway

Projects funded under 23 U.S.C. 117, and National Highway Freight Program projects funded under 23 U.S.C. 167.

The following provisions are from the U.S. Department of Labor regulations in 29 CFR 5.5 "Contract provisions and related matters" with minor revisions to conform to the FHWA-1273 format and FHWA program requirements.

1. Minimum wages (29 CFR 5.5)

a. *Wage rates and fringe benefits.* All laborers and mechanics employed or working upon the site of the work (or otherwise working in construction or development of the project under a development statute), will be paid unconditionally and not less often than once a week, and without subsequent deduction or rebate on any account (except such payroll deductions as are permitted by regulations issued by the Secretary of Labor under the Copeland Act ([29 CFR part 3](#))), the full amount of basic hourly wages and bona fide fringe benefits (or cash equivalents thereof) due at time of payment computed at rates not less than those contained in the wage determination of the Secretary of Labor which is attached hereto and made a part hereof, regardless of any contractual relationship which may be alleged to exist between the contractor and such laborers and mechanics. As provided in paragraphs (d) and (e) of 29 CFR 5.5, the appropriate wage determinations are effective by operation of law even if they have not been attached to the contract. Contributions made or costs reasonably anticipated for bona fide fringe benefits under the Davis-Bacon Act ([40 U.S.C. 3141\(2\)\(B\)](#)) on behalf of laborers or mechanics are considered wages paid to such laborers or mechanics, subject to the provisions of paragraph 1.e. of this section; also, regular contributions made or costs incurred for more than a weekly period (but not less often than quarterly) under plans, funds, or programs which cover the particular weekly period, are deemed to be constructively made or incurred during such weekly period. Such laborers and mechanics must be paid the appropriate wage rate and fringe benefits on the wage determination for the classification(s) of work actually performed, without regard to skill, except as provided in paragraph 4. of this section. Laborers or mechanics performing work in more than one classification may be compensated at the rate specified for each classification for the time actually worked therein: *Provided*, That the employer's payroll records accurately set forth the time spent in each classification in which work is performed. The wage determination (including any additional classifications and wage rates conformed under paragraph 1.c. of this section) and the Davis-Bacon poster (WH-1321) must be posted at all times by the contractor and its subcontractors at the site of the work in a prominent and accessible place where it can be easily seen by the workers.

b. *Frequently recurring classifications.* (1) In addition to wage and fringe benefit rates that have been determined to be prevailing under the procedures set forth in [29 CFR part 1](#), a wage determination may contain, pursuant to § 1.3(f), wage and fringe benefit rates for classifications of laborers and mechanics for which conformance requests are regularly submitted pursuant to paragraph 1.c. of this section, provided that:

(i) The work performed by the classification is not performed by a classification in the wage determination for which a prevailing wage rate has been determined;

(ii) The classification is used in the area by the construction industry; and

(iii) The wage rate for the classification bears a reasonable relationship to the prevailing wage rates contained in the wage determination.

(2) The Administrator will establish wage rates for such classifications in accordance with paragraph 1.c.(1)(iii) of this section. Work performed in such a classification must be paid at no less than the wage and fringe benefit rate listed on the wage determination for such classification.

c. *Conformance.* (1) The contracting officer must require that any class of laborers or mechanics, including helpers, which is not listed in the wage determination and which is to be employed under the contract be classified in conformance with the wage determination. Conformance of an additional classification and wage rate and fringe benefits is appropriate only when the following criteria have been met:

(i) The work to be performed by the classification requested is not performed by a classification in the wage determination; and

(ii) The classification is used in the area by the construction industry; and

(iii) The proposed wage rate, including any bona fide fringe benefits, bears a reasonable relationship to the wage rates contained in the wage determination.

(2) The conformance process may not be used to split, subdivide, or otherwise avoid application of classifications listed in the wage determination.

(3) If the contractor and the laborers and mechanics to be employed in the classification (if known), or their representatives, and the contracting officer agree on the classification and wage rate (including the amount designated for fringe benefits where appropriate), a report of the action taken will be sent by the contracting officer by email to DBAconformance@dol.gov. The Administrator, or an authorized representative, will approve, modify, or disapprove every additional classification action within 30 days of receipt and so advise the contracting officer or will notify the contracting officer within the 30-day period that additional time is necessary.

(4) In the event the contractor, the laborers or mechanics to be employed in the classification or their representatives, and the contracting officer do not agree on the proposed classification and wage rate (including the amount designated for fringe benefits, where appropriate), the contracting officer will, by email to DBAconformance@dol.gov, refer the questions, including the views of all interested parties and the recommendation of the contracting officer, to the Administrator for determination. The Administrator, or an authorized representative, will issue a determination within 30 days of receipt and so advise the contracting officer or will notify the contracting officer within the 30-day period that additional time is necessary.

(5) The contracting officer must promptly notify the contractor of the action taken by the Wage and Hour Division

under paragraphs 1.c.(3) and (4) of this section. The contractor must furnish a written copy of such determination to each affected worker or it must be posted as a part of the wage determination. The wage rate (including fringe benefits where appropriate) determined pursuant to paragraph 1.c.(3) or (4) of this section must be paid to all workers performing work in the classification under this contract from the first day on which work is performed in the classification.

d. *Fringe benefits not expressed as an hourly rate.* Whenever the minimum wage rate prescribed in the contract for a class of laborers or mechanics includes a fringe benefit which is not expressed as an hourly rate, the contractor may either pay the benefit as stated in the wage determination or may pay another bona fide fringe benefit or an hourly cash equivalent thereof.

e. *Unfunded plans.* If the contractor does not make payments to a trustee or other third person, the contractor may consider as part of the wages of any laborer or mechanic the amount of any costs reasonably anticipated in providing bona fide fringe benefits under a plan or program, *Provided*, That the Secretary of Labor has found, upon the written request of the contractor, in accordance with the criteria set forth in § 5.28, that the applicable standards of the Davis-Bacon Act have been met. The Secretary of Labor may require the contractor to set aside in a separate account assets for the meeting of obligations under the plan or program.

f. *Interest.* In the event of a failure to pay all or part of the wages required by the contract, the contractor will be required to pay interest on any underpayment of wages.

2. Withholding (29 CFR 5.5)

a. *Withholding requirements.* The contracting agency may, upon its own action, or must, upon written request of an authorized representative of the Department of Labor, withhold or cause to be withheld from the contractor so much of the accrued payments or advances as may be considered necessary to satisfy the liabilities of the prime contractor or any subcontractor for the full amount of wages and monetary relief, including interest, required by the clauses set forth in this section for violations of this contract, or to satisfy any such liabilities required by any other Federal contract, or federally assisted contract subject to Davis-Bacon labor standards, that is held by the same prime contractor (as defined in § 5.2). The necessary funds may be withheld from the contractor under this contract, any other Federal contract with the same prime contractor, or any other federally assisted contract that is subject to Davis-Bacon labor standards requirements and is held by the same prime contractor, regardless of whether the other contract was awarded or assisted by the same agency, and such funds may be used to satisfy the contractor liability for which the funds were withheld. In the event of a contractor's failure to pay any laborer or mechanic, including any apprentice or helper working on the site of the work all or part of the wages required by the contract, or upon the contractor's failure to submit the required records as discussed in paragraph 3.d. of this section, the contracting agency may on its own initiative and after written notice to the contractor, take such action as may be necessary to cause the suspension of any further payment, advance, or guarantee of funds until such violations have ceased.

b. *Priority to withheld funds.* The Department has priority to funds withheld or to be withheld in accordance with paragraph

2.a. of this section or Section V, paragraph 3.a., or both, over claims to those funds by:

- (1) A contractor's surety(ies), including without limitation performance bond sureties and payment bond sureties;
- (2) A contracting agency for its procurement costs;
- (3) A trustee(s) (either a court-appointed trustee or a U.S. trustee, or both) in bankruptcy of a contractor, or a contractor's bankruptcy estate;
- (4) A contractor's assignee(s);
- (5) A contractor's successor(s); or
- (6) A claim asserted under the Prompt Payment Act, [31 U.S.C. 3901–3907](#).

3. Records and certified payrolls (29 CFR 5.5)

a. *Basic record requirements (1) Length of record retention.* All regular payrolls and other basic records must be maintained by the contractor and any subcontractor during the course of the work and preserved for all laborers and mechanics working at the site of the work (or otherwise working in construction or development of the project under a development statute) for a period of at least 3 years after all the work on the prime contract is completed.

(2) *Information required.* Such records must contain the name; Social Security number; last known address, telephone number, and email address of each such worker; each worker's correct classification(s) of work actually performed; hourly rates of wages paid (including rates of contributions or costs anticipated for bona fide fringe benefits or cash equivalents thereof of the types described in [40 U.S.C. 3141\(2\)\(B\)](#) of the Davis-Bacon Act); daily and weekly number of hours actually worked in total and on each covered contract; deductions made; and actual wages paid.

(3) *Additional records relating to fringe benefits.* Whenever the Secretary of Labor has found under paragraph 1.e. of this section that the wages of any laborer or mechanic include the amount of any costs reasonably anticipated in providing benefits under a plan or program described in [40 U.S.C. 3141\(2\)\(B\)](#) of the Davis-Bacon Act, the contractor must maintain records which show that the commitment to provide such benefits is enforceable, that the plan or program is financially responsible, and that the plan or program has been communicated in writing to the laborers or mechanics affected, and records which show the costs anticipated or the actual cost incurred in providing such benefits.

(4) *Additional records relating to apprenticeship.* Contractors with apprentices working under approved programs must maintain written evidence of the registration of apprenticeship programs, the registration of the apprentices, and the ratios and wage rates prescribed in the applicable programs.

b. *Certified payroll requirements (1) Frequency and method of submission.* The contractor or subcontractor must submit weekly, for each week in which any DBA- or Related Acts-covered work is performed, certified payrolls to the contracting

agency. The prime contractor is responsible for the submission of all certified payrolls by all subcontractors. A contracting agency or prime contractor may permit or require contractors to submit certified payrolls through an electronic system, as long as the electronic system requires a legally valid electronic signature; the system allows the contractor, the contracting agency, and the Department of Labor to access the certified payrolls upon request for at least 3 years after the work on the prime contract has been completed; and the contracting agency or prime contractor permits other methods of submission in situations where the contractor is unable or limited in its ability to use or access the electronic system.

(2) *Information required.* The certified payrolls submitted must set out accurately and completely all of the information required to be maintained under paragraph 3.a.(2) of this section, except that full Social Security numbers and last known addresses, telephone numbers, and email addresses must not be included on weekly transmittals. Instead, the certified payrolls need only include an individually identifying number for each worker (e.g., the last four digits of the worker's Social Security number). The required weekly certified payroll information may be submitted using Optional Form WH-347 or in any other format desired. Optional Form WH-347 is available for this purpose from the Wage and Hour Division website at <https://www.dol.gov/sites/dolgov/files/WHD/legacy/files/wh347.pdf> or its successor website. It is not a violation of this section for a prime contractor to require a subcontractor to provide full Social Security numbers and last known addresses, telephone numbers, and email addresses to the prime contractor for its own records, without weekly submission by the subcontractor to the contracting agency.

(3) *Statement of Compliance.* Each certified payroll submitted must be accompanied by a "Statement of Compliance," signed by the contractor or subcontractor, or the contractor's or subcontractor's agent who pays or supervises the payment of the persons working on the contract, and must certify the following:

(i) That the certified payroll for the payroll period contains the information required to be provided under paragraph 3.b. of this section, the appropriate information and basic records are being maintained under paragraph 3.a. of this section, and such information and records are correct and complete;

(ii) That each laborer or mechanic (including each helper and apprentice) working on the contract during the payroll period has been paid the full weekly wages earned, without rebate, either directly or indirectly, and that no deductions have been made either directly or indirectly from the full wages earned, other than permissible deductions as set forth in [29 CFR part 3](#); and

(iii) That each laborer or mechanic has been paid not less than the applicable wage rates and fringe benefits or cash equivalents for the classification(s) of work actually performed, as specified in the applicable wage determination incorporated into the contract.

(4) *Use of Optional Form WH-347.* The weekly submission of a properly executed certification set forth on the reverse side of Optional Form WH-347 will satisfy the requirement for submission of the "Statement of Compliance" required by paragraph 3.b.(3) of this section.

(5) *Signature.* The signature by the contractor, subcontractor, or the contractor's or subcontractor's agent must be an original handwritten signature or a legally valid electronic signature.

(6) *Falsification.* The falsification of any of the above certifications may subject the contractor or subcontractor to civil or criminal prosecution under [18 U.S.C. 1001](#) and [31 U.S.C. 3729](#).

(7) *Length of certified payroll retention.* The contractor or subcontractor must preserve all certified payrolls during the course of the work and for a period of 3 years after all the work on the prime contract is completed.

c. *Contracts, subcontracts, and related documents.* The contractor or subcontractor must maintain this contract or subcontract and related documents including, without limitation, bids, proposals, amendments, modifications, and extensions. The contractor or subcontractor must preserve these contracts, subcontracts, and related documents during the course of the work and for a period of 3 years after all the work on the prime contract is completed.

d. *Required disclosures and access (1) Required record disclosures and access to workers.* The contractor or subcontractor must make the records required under paragraphs 3.a. through 3.c. of this section, and any other documents that the contracting agency, the State DOT, the FHWA, or the Department of Labor deems necessary to determine compliance with the labor standards provisions of any of the applicable statutes referenced by § 5.1, available for inspection, copying, or transcription by authorized representatives of the contracting agency, the State DOT, the FHWA, or the Department of Labor, and must permit such representatives to interview workers during working hours on the job.

(2) *Sanctions for non-compliance with records and worker access requirements.* If the contractor or subcontractor fails to submit the required records or to make them available, or refuses to permit worker interviews during working hours on the job, the Federal agency may, after written notice to the contractor, sponsor, applicant, owner, or other entity, as the case may be, that maintains such records or that employs such workers, take such action as may be necessary to cause the suspension of any further payment, advance, or guarantee of funds. Furthermore, failure to submit the required records upon request or to make such records available, or to permit worker interviews during working hours on the job, may be grounds for debarment action pursuant to § 5.12. In addition, any contractor or other person that fails to submit the required records or make those records available to WHD within the time WHD requests that the records be produced will be precluded from introducing as evidence in an administrative proceeding under [29 CFR part 6](#) any of the required records that were not provided or made available to WHD. WHD will take into consideration a reasonable request from the contractor or person for an extension of the time for submission of records. WHD will determine the reasonableness of the request and may consider, among other things, the location of the records and the volume of production.

(3) *Required information disclosures.* Contractors and subcontractors must maintain the full Social Security number and last known address, telephone number, and email address

of each covered worker, and must provide them upon request to the contracting agency, the State DOT, the FHWA, the contractor, or the Wage and Hour Division of the Department of Labor for purposes of an investigation or other compliance action.

4. Apprentices and equal employment opportunity (29 CFR 5.5)

a. *Apprentices (1) Rate of pay.* Apprentices will be permitted to work at less than the predetermined rate for the work they perform when they are employed pursuant to and individually registered in a bona fide apprenticeship program registered with the U.S. Department of Labor, Employment and Training Administration, Office of Apprenticeship (OA), or with a State Apprenticeship Agency recognized by the OA. A person who is not individually registered in the program, but who has been certified by the OA or a State Apprenticeship Agency (where appropriate) to be eligible for probationary employment as an apprentice, will be permitted to work at less than the predetermined rate for the work they perform in the first 90 days of probationary employment as an apprentice in such a program. In the event the OA or a State Apprenticeship Agency recognized by the OA withdraws approval of an apprenticeship program, the contractor will no longer be permitted to use apprentices at less than the applicable predetermined rate for the work performed until an acceptable program is approved.

(2) *Fringe benefits.* Apprentices must be paid fringe benefits in accordance with the provisions of the apprenticeship program. If the apprenticeship program does not specify fringe benefits, apprentices must be paid the full amount of fringe benefits listed on the wage determination for the applicable classification. If the Administrator determines that a different practice prevails for the applicable apprentice classification, fringe benefits must be paid in accordance with that determination.

(3) *Apprenticeship ratio.* The allowable ratio of apprentices to journeyworkers on the job site in any craft classification must not be greater than the ratio permitted to the contractor as to the entire work force under the registered program or the ratio applicable to the locality of the project pursuant to paragraph 4.a.(4) of this section. Any worker listed on a payroll at an apprentice wage rate, who is not registered or otherwise employed as stated in paragraph 4.a.(1) of this section, must be paid not less than the applicable wage rate on the wage determination for the classification of work actually performed. In addition, any apprentice performing work on the job site in excess of the ratio permitted under this section must be paid not less than the applicable wage rate on the wage determination for the work actually performed.

(4) *Reciprocity of ratios and wage rates.* Where a contractor is performing construction on a project in a locality other than the locality in which its program is registered, the ratios and wage rates (expressed in percentages of the journeyworker's hourly rate) applicable within the locality in which the construction is being performed must be observed. If there is no applicable ratio or wage rate for the locality of the project, the ratio and wage rate specified in the contractor's registered program must be observed.

b. *Equal employment opportunity.* The use of apprentices and journeyworkers under this part must be in conformity with

the equal employment opportunity requirements of Executive Order 11246, as amended, and [29 CFR part 30](#).

c. Apprentices and Trainees (programs of the U.S. DOT).

Apprentices and trainees working under apprenticeship and skill training programs which have been certified by the Secretary of Transportation as promoting EEO in connection with Federal-aid highway construction programs are not subject to the requirements of paragraph 4 of this Section IV. 23 CFR 230.111(e)(2). The straight time hourly wage rates for apprentices and trainees under such programs will be established by the particular programs. The ratio of apprentices and trainees to journeyworkers shall not be greater than permitted by the terms of the particular program.

5. Compliance with Copeland Act requirements. The contractor shall comply with the requirements of 29 CFR part 3, which are incorporated by reference in this contract as provided in 29 CFR 5.5.

6. Subcontracts. The contractor or subcontractor must insert FHWA-1273 in any subcontracts, along with the applicable wage determination(s) and such other clauses or contract modifications as the contracting agency may by appropriate instructions require, and a clause requiring the subcontractors to include these clauses and wage determination(s) in any lower tier subcontracts. The prime contractor is responsible for the compliance by any subcontractor or lower tier subcontractor with all the contract clauses in this section. In the event of any violations of these clauses, the prime contractor and any subcontractor(s) responsible will be liable for any unpaid wages and monetary relief, including interest from the date of the underpayment or loss, due to any workers of lower-tier subcontractors, and may be subject to debarment, as appropriate. 29 CFR 5.5.

7. Contract termination: debarment. A breach of the contract clauses in 29 CFR 5.5 may be grounds for termination of the contract, and for debarment as a contractor and a subcontractor as provided in 29 CFR 5.12.

8. Compliance with Davis-Bacon and Related Act requirements. All rulings and interpretations of the Davis-Bacon and Related Acts contained in 29 CFR parts 1, 3, and 5 are herein incorporated by reference in this contract as provided in 29 CFR 5.5.

9. Disputes concerning labor standards. As provided in 29 CFR 5.5, disputes arising out of the labor standards provisions of this contract shall not be subject to the general disputes clause of this contract. Such disputes shall be resolved in accordance with the procedures of the Department of Labor set forth in 29 CFR parts 5, 6, and 7. Disputes within the meaning of this clause include disputes between the contractor (or any of its subcontractors) and the contracting agency, the U.S. Department of Labor, or the employees or their representatives.

10. Certification of eligibility. a. By entering into this contract, the contractor certifies that neither it nor any person or firm who has an interest in the contractor's firm is a person or firm ineligible to be awarded Government contracts by virtue of [40 U.S.C. 3144\(b\)](#) or § 5.12(a).

b. No part of this contract shall be subcontracted to any person or firm ineligible for award of a Government contract by virtue of [40 U.S.C. 3144\(b\)](#) or § 5.12(a).

c. The penalty for making false statements is prescribed in the U.S. Code, Title 18 Crimes and Criminal Procedure, [18 U.S.C. 1001](#).

11. Anti-retaliation. It is unlawful for any person to discharge, demote, intimidate, threaten, restrain, coerce, blacklist, harass, or in any other manner discriminate against, or to cause any person to discharge, demote, intimidate, threaten, restrain, coerce, blacklist, harass, or in any other manner discriminate against, any worker or job applicant for:

a. Notifying any contractor of any conduct which the worker reasonably believes constitutes a violation of the DBA, Related Acts, this part, or [29 CFR part 1](#) or [3](#);

b. Filing any complaint, initiating or causing to be initiated any proceeding, or otherwise asserting or seeking to assert on behalf of themselves or others any right or protection under the DBA, Related Acts, this part, or [29 CFR part 1](#) or [3](#);

c. Cooperating in any investigation or other compliance action, or testifying in any proceeding under the DBA, Related Acts, this part, or [29 CFR part 1](#) or [3](#); or

d. Informing any other person about their rights under the DBA, Related Acts, this part, or [29 CFR part 1](#) or [3](#).

V. CONTRACT WORK HOURS AND SAFETY STANDARDS ACT

Pursuant to 29 CFR 5.5(b), the following clauses apply to any Federal-aid construction contract in an amount in excess of \$100,000 and subject to the overtime provisions of the Contract Work Hours and Safety Standards Act. These clauses shall be inserted in addition to the clauses required by 29 CFR 5.5(a) or 29 CFR 4.6. As used in this paragraph, the terms laborers and mechanics include watchpersons and guards.

1. Overtime requirements. No contractor or subcontractor contracting for any part of the contract work which may require or involve the employment of laborers or mechanics shall require or permit any such laborer or mechanic in any workweek in which he or she is employed on such work to work in excess of forty hours in such workweek unless such laborer or mechanic receives compensation at a rate not less than one and one-half times the basic rate of pay for all hours worked in excess of forty hours in such workweek. 29 CFR 5.5.

2. Violation; liability for unpaid wages; liquidated damages. In the event of any violation of the clause set forth in paragraph 1. of this section the contractor and any subcontractor responsible therefor shall be liable for the unpaid wages and interest from the date of the underpayment. In addition, such contractor and subcontractor shall be liable to the United States (in the case of work done under contract for the District of Columbia or a territory, to such District or to such territory), for liquidated damages. Such liquidated damages shall be computed with respect to each individual laborer or

mechanic, including watchpersons and guards, employed in violation of the clause set forth in paragraph 1. of this section, in the sum currently provided in 29 CFR 5.5(b)(2)* for each calendar day on which such individual was required or permitted to work in excess of the standard workweek of forty hours without payment of the overtime wages required by the clause set forth in paragraph 1. of this section.

* \$31 as of January 15, 2023 (See 88 FR 88 FR 2210) as may be adjusted annually by the Department of Labor, pursuant to the Federal Civil Penalties Inflation Adjustment Act of 1990.

3. Withholding for unpaid wages and liquidated damages

a. *Withholding process.* The FHWA or the contracting agency may, upon its own action, or must, upon written request of an authorized representative of the Department of Labor, withhold or cause to be withheld from the contractor so much of the accrued payments or advances as may be considered necessary to satisfy the liabilities of the prime contractor or any subcontractor for any unpaid wages; monetary relief, including interest; and liquidated damages required by the clauses set forth in this section on this contract, any other Federal contract with the same prime contractor, or any other federally assisted contract subject to the Contract Work Hours and Safety Standards Act that is held by the same prime contractor (as defined in § 5.2). The necessary funds may be withheld from the contractor under this contract, any other Federal contract with the same prime contractor, or any other federally assisted contract that is subject to the Contract Work Hours and Safety Standards Act and is held by the same prime contractor, regardless of whether the other contract was awarded or assisted by the same agency, and such funds may be used to satisfy the contractor liability for which the funds were withheld.

b. *Priority to withheld funds.* The Department has priority to funds withheld or to be withheld in accordance with Section IV paragraph 2.a. or paragraph 3.a. of this section, or both, over claims to those funds by:

- (1) A contractor's surety(ies), including without limitation performance bond sureties and payment bond sureties;
- (2) A contracting agency for its procurement costs;
- (3) A trustee(s) (either a court-appointed trustee or a U.S. trustee, or both) in bankruptcy of a contractor, or a contractor's bankruptcy estate;
- (4) A contractor's assignee(s);
- (5) A contractor's successor(s); or
- (6) A claim asserted under the Prompt Payment Act, [31 U.S.C. 3901](#)–3907.

4. **Subcontracts.** The contractor or subcontractor must insert in any subcontracts the clauses set forth in paragraphs 1. through 5. of this section and a clause requiring the subcontractors to include these clauses in any lower tier subcontracts. The prime contractor is responsible for compliance by any subcontractor or lower tier subcontractor with the clauses set forth in paragraphs 1. through 5. In the

event of any violations of these clauses, the prime contractor and any subcontractor(s) responsible will be liable for any unpaid wages and monetary relief, including interest from the date of the underpayment or loss, due to any workers of lower-tier subcontractors, and associated liquidated damages and may be subject to debarment, as appropriate.

5. Anti-retaliation. It is unlawful for any person to discharge, demote, intimidate, threaten, restrain, coerce, blacklist, harass, or in any other manner discriminate against, or to cause any person to discharge, demote, intimidate, threaten, restrain, coerce, blacklist, harass, or in any other manner discriminate against, any worker or job applicant for:

a. Notifying any contractor of any conduct which the worker reasonably believes constitutes a violation of the Contract Work Hours and Safety Standards Act (CWHSSA) or its implementing regulations in this part;

b. Filing any complaint, initiating or causing to be initiated any proceeding, or otherwise asserting or seeking to assert on behalf of themselves or others any right or protection under CWHSSA or this part;

c. Cooperating in any investigation or other compliance action, or testifying in any proceeding under CWHSSA or this part; or

d. Informing any other person about their rights under CWHSSA or this part.

VI. SUBLETTING OR ASSIGNING THE CONTRACT

This provision is applicable to all Federal-aid construction contracts on the National Highway System pursuant to 23 CFR 635.116.

1. The contractor shall perform with its own organization contract work amounting to not less than 30 percent (or a greater percentage if specified elsewhere in the contract) of the total original contract price, excluding any specialty items designated by the contracting agency. Specialty items may be performed by subcontract and the amount of any such specialty items performed may be deducted from the total original contract price before computing the amount of work required to be performed by the contractor's own organization (23 CFR 635.116).

a. The term "perform work with its own organization" in paragraph 1 of Section VI refers to workers employed or leased by the prime contractor, and equipment owned or rented by the prime contractor, with or without operators. Such term does not include employees or equipment of a subcontractor or lower tier subcontractor, agents of the prime contractor, or any other assignees. The term may include payments for the costs of hiring leased employees from an employee leasing firm meeting all relevant Federal and State regulatory requirements. Leased employees may only be included in this term if the prime contractor meets all of the following conditions: (based on longstanding interpretation)

- (1) the prime contractor maintains control over the supervision of the day-to-day activities of the leased employees;
- (2) the prime contractor remains responsible for the quality of the work of the leased employees;

- (3) the prime contractor retains all power to accept or exclude individual employees from work on the project; and
- (4) the prime contractor remains ultimately responsible for the payment of predetermined minimum wages, the submission of payrolls, statements of compliance and all other Federal regulatory requirements.

b. "Specialty Items" shall be construed to be limited to work that requires highly specialized knowledge, abilities, or equipment not ordinarily available in the type of contracting organizations qualified and expected to bid or propose on the contract as a whole and in general are to be limited to minor components of the overall contract. 23 CFR 635.102.

2. Pursuant to 23 CFR 635.116(a), the contract amount upon which the requirements set forth in paragraph (1) of Section VI is computed includes the cost of material and manufactured products which are to be purchased or produced by the contractor under the contract provisions.

3. Pursuant to 23 CFR 635.116(c), the contractor shall furnish (a) a competent superintendent or supervisor who is employed by the firm, has full authority to direct performance of the work in accordance with the contract requirements, and is in charge of all construction operations (regardless of who performs the work) and (b) such other of its own organizational resources (supervision, management, and engineering services) as the contracting officer determines is necessary to assure the performance of the contract.

4. No portion of the contract shall be sublet, assigned or otherwise disposed of except with the written consent of the contracting officer, or authorized representative, and such consent when given shall not be construed to relieve the contractor of any responsibility for the fulfillment of the contract. Written consent will be given only after the contracting agency has assured that each subcontract is evidenced in writing and that it contains all pertinent provisions and requirements of the prime contract. (based on long-standing interpretation of 23 CFR 635.116).

5. The 30-percent self-performance requirement of paragraph (1) is not applicable to design-build contracts; however, contracting agencies may establish their own self-performance requirements. 23 CFR 635.116(d).

VII. SAFETY: ACCIDENT PREVENTION

This provision is applicable to all Federal-aid construction contracts and to all related subcontracts.

1. In the performance of this contract the contractor shall comply with all applicable Federal, State, and local laws governing safety, health, and sanitation (23 CFR Part 635). The contractor shall provide all safeguards, safety devices and protective equipment and take any other needed actions as it determines, or as the contracting officer may determine, to be reasonably necessary to protect the life and health of employees on the job and the safety of the public and to protect property in connection with the performance of the work covered by the contract. 23 CFR 635.108.

2. It is a condition of this contract, and shall be made a condition of each subcontract, which the contractor enters into pursuant to this contract, that the contractor and any subcontractor shall not permit any employee, in performance of the contract, to work in surroundings or under conditions which are unsanitary, hazardous or dangerous to his/her health or safety, as determined under construction safety and

health standards (29 CFR Part 1926) promulgated by the Secretary of Labor, in accordance with Section 107 of the Contract Work Hours and Safety Standards Act (40 U.S.C. 3704). 29 CFR 1926.10.

3. Pursuant to 29 CFR 1926.3, it is a condition of this contract that the Secretary of Labor or authorized representative thereof, shall have right of entry to any site of contract performance to inspect or investigate the matter of compliance with the construction safety and health standards and to carry out the duties of the Secretary under Section 107 of the Contract Work Hours and Safety Standards Act (40 U.S.C. 3704).

VIII. FALSE STATEMENTS CONCERNING HIGHWAY PROJECTS

This provision is applicable to all Federal-aid construction contracts and to all related subcontracts.

In order to assure high quality and durable construction in conformity with approved plans and specifications and a high degree of reliability on statements and representations made by engineers, contractors, suppliers, and workers on Federal-aid highway projects, it is essential that all persons concerned with the project perform their functions as carefully, thoroughly, and honestly as possible. Willful falsification, distortion, or misrepresentation with respect to any facts related to the project is a violation of Federal law. To prevent any misunderstanding regarding the seriousness of these and similar acts, Form FHWA-1022 shall be posted on each Federal-aid highway project (23 CFR Part 635) in one or more places where it is readily available to all persons concerned with the project:

18 U.S.C. 1020 reads as follows:

"Whoever, being an officer, agent, or employee of the United States, or of any State or Territory, or whoever, whether a person, association, firm, or corporation, knowingly makes any false statement, false representation, or false report as to the character, quality, quantity, or cost of the material used or to be used, or the quantity or quality of the work performed or to be performed, or the cost thereof in connection with the submission of plans, maps, specifications, contracts, or costs of construction on any highway or related project submitted for approval to the Secretary of Transportation; or

Whoever knowingly makes any false statement, false representation, false report or false claim with respect to the character, quality, quantity, or cost of any work performed or to be performed, or materials furnished or to be furnished, in connection with the construction of any highway or related project approved by the Secretary of Transportation; or

Whoever knowingly makes any false statement or false representation as to material fact in any statement, certificate, or report submitted pursuant to provisions of the Federal-aid Roads Act approved July 11, 1916, (39 Stat. 355), as amended and supplemented;

Shall be fined under this title or imprisoned not more than 5 years or both."

IX. IMPLEMENTATION OF CLEAN AIR ACT AND FEDERAL WATER POLLUTION CONTROL ACT (42 U.S.C. 7606; 2 CFR 200.88; EO 11738)

This provision is applicable to all Federal-aid construction contracts in excess of \$150,000 and to all related subcontracts. 48 CFR 2.101; 2 CFR 200.327.

By submission of this bid/proposal or the execution of this contract or subcontract, as appropriate, the bidder, proposer, Federal-aid construction contractor, subcontractor, supplier, or vendor agrees to comply with all applicable standards, orders or regulations issued pursuant to the Clean Air Act (42 U.S.C. 7401-7671q) and the Federal Water Pollution Control Act, as amended (33 U.S.C. 1251-1387). Violations must be reported to the Federal Highway Administration and the Regional Office of the Environmental Protection Agency. 2 CFR Part 200, Appendix II.

The contractor agrees to include or cause to be included the requirements of this Section in every subcontract, and further agrees to take such action as the contracting agency may direct as a means of enforcing such requirements. 2 CFR 200.327.

X. CERTIFICATION REGARDING DEBARMENT, SUSPENSION, INELIGIBILITY AND VOLUNTARY EXCLUSION

This provision is applicable to all Federal-aid construction contracts, design-build contracts, subcontracts, lower-tier subcontracts, purchase orders, lease agreements, consultant contracts or any other covered transaction requiring FHWA approval or that is estimated to cost \$25,000 or more – as defined in 2 CFR Parts 180 and 1200. 2 CFR 180.220 and 1200.220.

1. Instructions for Certification – First Tier Participants:

- a. By signing and submitting this proposal, the prospective first tier participant is providing the certification set out below.
- b. The inability of a person to provide the certification set out below will not necessarily result in denial of participation in this covered transaction. The prospective first tier participant shall submit an explanation of why it cannot provide the certification set out below. The certification or explanation will be considered in connection with the department or agency's determination whether to enter into this transaction. However, failure of the prospective first tier participant to furnish a certification or an explanation shall disqualify such a person from participation in this transaction. 2 CFR 180.320.
- c. The certification in this clause is a material representation of fact upon which reliance was placed when the contracting agency determined to enter into this transaction. If it is later determined that the prospective participant knowingly rendered an erroneous certification, in addition to other remedies available to the Federal Government, the contracting agency may terminate this transaction for cause of default. 2 CFR 180.325.
- d. The prospective first tier participant shall provide immediate written notice to the contracting agency to whom this proposal is submitted if any time the prospective first tier participant learns that its certification was erroneous when submitted or has become erroneous by reason of changed circumstances. 2 CFR 180.345 and 180.350.

e. The terms "covered transaction," "debarred," "suspended," "ineligible," "participant," "person," "principal," and "voluntarily excluded," as used in this clause, are defined in 2 CFR Parts 180, Subpart I, 180.900-180.1020, and 1200. "First Tier Covered Transactions" refers to any covered transaction between a recipient or subrecipient of Federal funds and a participant (such as the prime or general contract). "Lower Tier Covered Transactions" refers to any covered transaction under a First Tier Covered Transaction (such as subcontracts). "First Tier Participant" refers to the participant who has entered into a covered transaction with a recipient or subrecipient of Federal funds (such as the prime or general contractor). "Lower Tier Participant" refers any participant who has entered into a covered transaction with a First Tier Participant or other Lower Tier Participants (such as subcontractors and suppliers).

f. The prospective first tier participant agrees by submitting this proposal that, should the proposed covered transaction be entered into, it shall not knowingly enter into any lower tier covered transaction with a person who is debarred, suspended, declared ineligible, or voluntarily excluded from participation in this covered transaction, unless authorized by the department or agency entering into this transaction. 2 CFR 180.330.

g. The prospective first tier participant further agrees by submitting this proposal that it will include the clause titled "Certification Regarding Debarment, Suspension, Ineligibility and Voluntary Exclusion-Lower Tier Covered Transactions," provided by the department or contracting agency, entering into this covered transaction, without modification, in all lower tier covered transactions and in all solicitations for lower tier covered transactions exceeding the \$25,000 threshold. 2 CFR 180.220 and 180.300.

h. A participant in a covered transaction may rely upon a certification of a prospective participant in a lower tier covered transaction that is not debarred, suspended, ineligible, or voluntarily excluded from the covered transaction, unless it knows that the certification is erroneous. 2 CFR 180.300; 180.320, and 180.325. A participant is responsible for ensuring that its principals are not suspended, debarred, or otherwise ineligible to participate in covered transactions. 2 CFR 180.335. To verify the eligibility of its principals, as well as the eligibility of any lower tier prospective participants, each participant may, but is not required to, check the System for Award Management website (<https://www.sam.gov/>). 2 CFR 180.300, 180.320, and 180.325.

i. Nothing contained in the foregoing shall be construed to require the establishment of a system of records in order to render in good faith the certification required by this clause. The knowledge and information of the prospective participant is not required to exceed that which is normally possessed by a prudent person in the ordinary course of business dealings.

j. Except for transactions authorized under paragraph (f) of these instructions, if a participant in a covered transaction knowingly enters into a lower tier covered transaction with a person who is suspended, debarred, ineligible, or voluntarily excluded from participation in this transaction, in addition to other remedies available to the Federal Government, the department or agency may terminate this transaction for cause or default. 2 CFR 180.325.

2. Certification Regarding Debarment, Suspension, Ineligibility and Voluntary Exclusion – First Tier Participants:

a. The prospective first tier participant certifies to the best of its knowledge and belief, that it and its principals:

(1) Are not presently debarred, suspended, proposed for debarment, declared ineligible, or voluntarily excluded from participating in covered transactions by any Federal department or agency, 2 CFR 180.335;

(2) Have not within a three-year period preceding this proposal been convicted of or had a civil judgment rendered against them for commission of fraud or a criminal offense in connection with obtaining, attempting to obtain, or performing a public (Federal, State, or local) transaction or contract under a public transaction; violation of Federal or State antitrust statutes or commission of embezzlement, theft, forgery, bribery, falsification or destruction of records, making false statements, or receiving stolen property, 2 CFR 180.800;

(3) Are not presently indicted for or otherwise criminally or civilly charged by a governmental entity (Federal, State or local) with commission of any of the offenses enumerated in paragraph (a)(2) of this certification, 2 CFR 180.700 and 180.800; and

(4) Have not within a three-year period preceding this application/proposal had one or more public transactions (Federal, State or local) terminated for cause or default. 2 CFR 180.335(d).

(5) Are not a corporation that has been convicted of a felony violation under any Federal law within the two-year period preceding this proposal (USDOT Order 4200.6 implementing appropriations act requirements); and

(6) Are not a corporation with any unpaid Federal tax liability that has been assessed, for which all judicial and administrative remedies have been exhausted, or have lapsed, and that is not being paid in a timely manner pursuant to an agreement with the authority responsible for collecting the tax liability (USDOT Order 4200.6 implementing appropriations act requirements).

b. Where the prospective participant is unable to certify to any of the statements in this certification, such prospective participant should attach an explanation to this proposal. 2 CFR 180.335 and 180.340.

3. Instructions for Certification - Lower Tier Participants:

(Applicable to all subcontracts, purchase orders, and other lower tier transactions requiring prior FHWA approval or estimated to cost \$25,000 or more - 2 CFR Parts 180 and 1200). 2 CFR 180.220 and 1200.220.

a. By signing and submitting this proposal, the prospective lower tier participant is providing the certification set out below.

b. The certification in this clause is a material representation of fact upon which reliance was placed when this transaction was entered into. If it is later determined that the prospective lower tier participant knowingly rendered an erroneous certification, in addition to other remedies available to the Federal Government, the department, or agency with which

this transaction originated may pursue available remedies, including suspension and/or debarment.

c. The prospective lower tier participant shall provide immediate written notice to the person to which this proposal is submitted if at any time the prospective lower tier participant learns that its certification was erroneous by reason of changed circumstances. 2 CFR 180.365.

d. The terms "covered transaction," "debarred," "suspended," "ineligible," "participant," "person," "principal," and "voluntarily excluded," as used in this clause, are defined in 2 CFR Parts 180, Subpart I, 180.900 – 180.1020, and 1200. You may contact the person to which this proposal is submitted for assistance in obtaining a copy of those regulations. "First Tier Covered Transactions" refers to any covered transaction between a recipient or subrecipient of Federal funds and a participant (such as the prime or general contract). "Lower Tier Covered Transactions" refers to any covered transaction under a First Tier Covered Transaction (such as subcontracts). "First Tier Participant" refers to the participant who has entered into a covered transaction with a recipient or subrecipient of Federal funds (such as the prime or general contractor). "Lower Tier Participant" refers any participant who has entered into a covered transaction with a First Tier Participant or other Lower Tier Participants (such as subcontractors and suppliers).

e. The prospective lower tier participant agrees by submitting this proposal that, should the proposed covered transaction be entered into, it shall not knowingly enter into any lower tier covered transaction with a person who is debarred, suspended, declared ineligible, or voluntarily excluded from participation in this covered transaction, unless authorized by the department or agency with which this transaction originated. 2 CFR 1200.220 and 1200.332.

f. The prospective lower tier participant further agrees by submitting this proposal that it will include this clause titled "Certification Regarding Debarment, Suspension, Ineligibility and Voluntary Exclusion-Lower Tier Covered Transaction," without modification, in all lower tier covered transactions and in all solicitations for lower tier covered transactions exceeding the \$25,000 threshold. 2 CFR 180.220 and 1200.220.

g. A participant in a covered transaction may rely upon a certification of a prospective participant in a lower tier covered transaction that is not debarred, suspended, ineligible, or voluntarily excluded from the covered transaction, unless it knows that the certification is erroneous. A participant is responsible for ensuring that its principals are not suspended, debarred, or otherwise ineligible to participate in covered transactions. To verify the eligibility of its principals, as well as the eligibility of any lower tier prospective participants, each participant may, but is not required to, check the System for Award Management website (<https://www.sam.gov/>), which is compiled by the General Services Administration. 2 CFR 180.300, 180.320, 180.330, and 180.335.

h. Nothing contained in the foregoing shall be construed to require establishment of a system of records in order to render in good faith the certification required by this clause. The knowledge and information of participant is not required to exceed that which is normally possessed by a prudent person in the ordinary course of business dealings.

i. Except for transactions authorized under paragraph e of these instructions, if a participant in a covered transaction knowingly enters into a lower tier covered transaction with a person who is suspended, debarred, ineligible, or voluntarily

excluded from participation in this transaction, in addition to other remedies available to the Federal Government, the department or agency with which this transaction originated may pursue available remedies, including suspension and/or debarment. 2 CFR 180.325.

* * * * *

4. Certification Regarding Debarment, Suspension, Ineligibility and Voluntary Exclusion--Lower Tier Participants:

a. The prospective lower tier participant certifies, by submission of this proposal, that neither it nor its principals:

(1) is presently debarred, suspended, proposed for debarment, declared ineligible, or voluntarily excluded from participating in covered transactions by any Federal department or agency, 2 CFR 180.355;

(2) is a corporation that has been convicted of a felony violation under any Federal law within the two-year period preceding this proposal (USDOT Order 4200.6 implementing appropriations act requirements); and

(3) is a corporation with any unpaid Federal tax liability that has been assessed, for which all judicial and administrative remedies have been exhausted, or have lapsed, and that is not being paid in a timely manner pursuant to an agreement with the authority responsible for collecting the tax liability. (USDOT Order 4200.6 implementing appropriations act requirements)

b. Where the prospective lower tier participant is unable to certify to any of the statements in this certification, such prospective participant should attach an explanation to this proposal.

* * * * *

XI. CERTIFICATION REGARDING USE OF CONTRACT FUNDS FOR LOBBYING

This provision is applicable to all Federal-aid construction contracts and to all related subcontracts which exceed \$100,000. 49 CFR Part 20, App. A.

1. The prospective participant certifies, by signing and submitting this bid or proposal, to the best of his or her knowledge and belief, that:

a. No Federal appropriated funds have been paid or will be paid, by or on behalf of the undersigned, to any person for influencing or attempting to influence an officer or employee of any Federal agency, a Member of Congress, an officer or employee of Congress, or an employee of a Member of Congress in connection with the awarding of any Federal contract, the making of any Federal grant, the making of any Federal loan, the entering into of any cooperative agreement, and the extension, continuation, renewal, amendment, or modification of any Federal contract, grant, loan, or cooperative agreement.

b. If any funds other than Federal appropriated funds have been paid or will be paid to any person for influencing or attempting to influence an officer or employee of any Federal agency, a Member of Congress, an officer or employee of Congress, or an employee of a Member of Congress in connection with this Federal contract, grant, loan, or

cooperative agreement, the undersigned shall complete and submit Standard Form-LLL, "Disclosure Form to Report Lobbying," in accordance with its instructions.

2. This certification is a material representation of fact upon which reliance was placed when this transaction was made or entered into. Submission of this certification is a prerequisite for making or entering into this transaction imposed by 31 U.S.C. 1352. Any person who fails to file the required certification shall be subject to a civil penalty of not less than \$10,000 and not more than \$100,000 for each such failure.

3. The prospective participant also agrees by submitting its bid or proposal that the participant shall require that the language of this certification be included in all lower tier subcontracts, which exceed \$100,000 and that all such recipients shall certify and disclose accordingly.

XII. USE OF UNITED STATES-FLAG VESSELS:

This provision is applicable to all Federal-aid construction contracts, design-build contracts, subcontracts, lower-tier subcontracts, purchase orders, lease agreements, or any other covered transaction. 46 CFR Part 381.

This requirement applies to material or equipment that is acquired for a specific Federal-aid highway project. 46 CFR 381.7. It is not applicable to goods or materials that come into inventories independent of an FHWA funded-contract.

When oceanic shipments (or shipments across the Great Lakes) are necessary for materials or equipment acquired for a specific Federal-aid construction project, the bidder, proposer, contractor, subcontractor, or vendor agrees:

1. To utilize privately owned United States-flag commercial vessels to ship at least 50 percent of the gross tonnage (computed separately for dry bulk carriers, dry cargo liners, and tankers) involved, whenever shipping any equipment, material, or commodities pursuant to this contract, to the extent such vessels are available at fair and reasonable rates for United States-flag commercial vessels. 46 CFR 381.7.

2. To furnish within 20 days following the date of loading for shipments originating within the United States or within 30 working days following the date of loading for shipments originating outside the United States, a legible copy of a rated, 'on-board' commercial ocean bill-of-lading in English for each shipment of cargo described in paragraph (b)(1) of this section to both the Contracting Officer (through the prime contractor in the case of subcontractor bills-of-lading) and to the Office of Cargo and Commercial Sealift (MAR-620), Maritime Administration, Washington, DC 20590. (MARAD requires copies of the ocean carrier's (master) bills of lading, certified onboard, dated, with rates and charges. These bills of lading may contain business sensitive information and therefore may be submitted directly to MARAD by the Ocean Transportation Intermediary on behalf of the contractor). 46 CFR 381.7.

**ATTACHMENT A - EMPLOYMENT AND MATERIALS
PREFERENCE FOR APPALACHIAN DEVELOPMENT
HIGHWAY SYSTEM OR APPALACHIAN LOCAL ACCESS
ROAD CONTRACTS (23 CFR 633, Subpart B, Appendix B)**

This provision is applicable to all Federal-aid projects funded under the Appalachian Regional Development Act of 1965.

1. During the performance of this contract, the contractor undertaking to do work which is, or reasonably may be, done as on-site work, shall give preference to qualified persons who regularly reside in the labor area as designated by the DOL wherein the contract work is situated, or the subregion, or the Appalachian counties of the State wherein the contract work is situated, except:

a. To the extent that qualified persons regularly residing in the area are not available.

b. For the reasonable needs of the contractor to employ supervisory or specially experienced personnel necessary to assure an efficient execution of the contract work.

c. For the obligation of the contractor to offer employment to present or former employees as the result of a lawful collective bargaining contract, provided that the number of nonresident persons employed under this subparagraph (1c) shall not exceed 20 percent of the total number of employees employed by the contractor on the contract work, except as provided in subparagraph (4) below.

2. The contractor shall place a job order with the State Employment Service indicating (a) the classifications of the laborers, mechanics and other employees required to perform the contract work, (b) the number of employees required in each classification, (c) the date on which the participant estimates such employees will be required, and (d) any other pertinent information required by the State Employment Service to complete the job order form. The job order may be placed with the State Employment Service in writing or by telephone. If during the course of the contract work, the information submitted by the contractor in the original job order is substantially modified, the participant shall promptly notify the State Employment Service.

3. The contractor shall give full consideration to all qualified job applicants referred to him by the State Employment Service. The contractor is not required to grant employment to any job applicants who, in his opinion, are not qualified to perform the classification of work required.

4. If, within one week following the placing of a job order by the contractor with the State Employment Service, the State Employment Service is unable to refer any qualified job applicants to the contractor, or less than the number requested, the State Employment Service will forward a certificate to the contractor indicating the unavailability of applicants. Such certificate shall be made a part of the contractor's permanent project records. Upon receipt of this certificate, the contractor may employ persons who do not normally reside in the labor area to fill positions covered by the certificate, notwithstanding the provisions of subparagraph (1c) above.

5. The provisions of 23 CFR 633.207(e) allow the contracting agency to provide a contractual preference for the use of mineral resource materials native to the Appalachian region.

6. The contractor shall include the provisions of Sections 1 through 4 of this Attachment A in every subcontract for work which is, or reasonably may be, done as on-site work.

The United States Department of Transportation (USDOT)

Standard Title VI/Non-Discrimination Assurances

DOT Order No. 1050.2A

The **Maine Department of Transportation** (herein referred to as the "Recipient"), **HEREBY AGREES THAT**, as a condition to receiving any Federal financial assistance from the U.S. Department of Transportation (DOT), through Federal Highway Administration (herein referred to as "FHWA" is subject to and will comply with the following:

Statutory/Regulatory Authorities

- Title VI of the Civil Rights Act of 1964 (42 U.S.C. § 2000d *et seq.*, 78 stat. 252), (prohibits discrimination on the basis of race, color, national origin);
- 49 C.F.R. Part 21 (entitled *Non-discrimination In Federally-Assisted Programs Of The Department Of Transportation-Effectuation Of Title VI Of The Civil Rights Act Of 1964*);
- 28 C.F.R. section 50.3 (U.S. Department of Justice Guidelines for Enforcement of Title VI of the Civil Rights Act of 1964);

The preceding statutory and regulatory cites hereinafter are referred to as the "Acts" and "Regulations," respectively.

General Assurances

In accordance with the Acts, the Regulations, and other pertinent directives, circulars, policy, memoranda, and/or guidance, the Recipient hereby gives assurance that it will promptly take any measures necessary to ensure that:

"No person in the United States shall, on the grounds of race, color, or national origin, be excluded from participation in, be denied the benefits of, or be otherwise subjected to discrimination under any program or activity, for which the Recipient receives Federal financial assistance from DOT, including the FHWA.

The Civil Rights Restoration Act of 1987 clarified the original intent of Congress, with respect to Title VI and other Non-discrimination requirements (The Age Discrimination Act of 1975, and Section 504 of the Rehabilitation Act of 1973), by restoring the broad, institutional-wide scope and coverage of these non-discrimination statutes and requirements to include all programs and activities of the Recipient, so long as any portion of the program is Federally assisted.

Specific Assurances

More specifically, and without limiting the above general Assurance, the Recipient agrees with and gives the following Assurances with respect to its Federally assisted **FHWA Program**.

1. The Recipient agrees that each "activity," "facility," or "program," as defined in §§ 21.23(b) and 21.2(e) of 49 C.F.R. § 21 will be (with regard to an "activity") facilitated, or will be (with regard to a "facility") operated, or will be (with regard to a "program") conducted in compliance with all requirements imposed by, or pursuant to the Acts and the Regulations.
2. The Recipient will insert the following notification in all solicitations for bids, Requests For Proposals for work, or material subject to the Acts and the Regulations made in connection with all **FHWA Programs** and, in adapted form, in all proposals for negotiated agreements regardless of funding source:

*"The **Maine Department of Transportation**, in accordance with the provisions of Title VI of the Civil Rights Act of 1964 (78 Stat. 252, 42 U.S.C. §§ 2000d to 2000d-4) and the Regulations, hereby notifies all bidders that it will affirmatively ensure that any contract entered into pursuant to this advertisement, disadvantaged business enterprises will be afforded full and fair opportunity to submit bids in response to this invitation and will not be discriminated against on the grounds of race, color, or national origin in consideration for an award."*

3. The Recipient will insert the clauses of Appendix A and E of this Assurance in every contract or agreement subject to the Acts and the Regulations.
4. The Recipient will insert the clauses of Appendix B of this Assurance, as a covenant running with the land, in any deed from the United States affecting or recording a transfer of real property, structures, use, or improvements thereon or interest therein to a Recipient.
5. That where the Recipient receives Federal financial assistance to construct a facility, or part of a facility, the Assurance will extend to the entire facility and facilities operated in connection therewith.
6. That where the Recipient receives Federal financial assistance in the form, or for the acquisition of real property or an interest in real property, the Assurance will extend to rights to space on, over, or under such property.
7. That the Recipient will include the clauses set forth in Appendix C and Appendix D of this Assurance, as a covenant running with the land, in any future deeds,

leases, licenses, permits, or similar instruments entered into by the Recipient with other parties:

- a. for the subsequent transfer of real property acquired or improved under the applicable activity, project, or program; and
 - b. for the construction or use of, or access to, space on, over, or under real property acquired or improved under the applicable activity, project, or program.
8. That this Assurance obligates the Recipient for the period during which Federal financial assistance is extended to the program, except where the Federal financial assistance is to provide, or is in the form of, personal property, or real property, or interest therein, or structures or improvements thereon, in which case the Assurance obligates the Recipient, or any transferee for the longer of the following periods:
- A. the period during which the property is used for a purpose for which the Federal financial assistance is extended, or for another purpose involving the provision of similar services or benefits; or
 - b. the period during which the Recipient retains ownership or possession of the property.
9. The Recipient will provide for such methods of administration for the program as are found by the Secretary of Transportation or the official to whom he/she delegates specific authority to give reasonable guarantee that it, other recipients, sub-recipients, sub-grantees, contractors, subcontractors, consultants, transferees, successors in interest, and other participants of Federal financial assistance under such program will comply with all requirements imposed or pursuant to the Acts, the Regulations, and this Assurance.
10. The Recipient agrees that the United States has a right to seek judicial enforcement with regard to any matter arising under the Acts, the Regulations, and this Assurance.

By signing this ASSURANCE, **Maine Department of Transportation** also agrees to comply (and require any sub-recipients, sub-grantees, contractors, successors, transferees, and/or assignees to comply) with all applicable provisions governing the **FHWA's** access to records, accounts, documents, information, facilities, and staff. You also recognize that you must comply with any program or compliance reviews, and/or complaint investigations conducted by the **FHWA**. You must keep records, reports, and submit the material for review upon request to **FHWA** or its designee in a timely, complete, and accurate way. Additionally, you must comply with all other reporting, data collection, and evaluation requirements, as prescribed by law or detailed in program guidance.

APPENDIX A

During the performance of this contract, the contractor, for itself, its assignees, and successors in interest (hereinafter referred to as the "contractor") agrees as follows:

1. **Compliance with Regulations:** The contractor (hereinafter includes consultants) will comply with the Acts and the Regulations relative to Non-discrimination in Federally-assisted programs of the U.S. Department of Transportation, **Federal Highway Administration (FHWA)**, as they may be amended from time to time, which are herein incorporated by reference and made a part of this contract.
2. **Non-discrimination:** The contractor, with regard to the work performed by it during the contract, will not discriminate on the grounds of race, color, or national origin in the selection and retention of subcontractors, including procurements of materials and leases of equipment. The contractor will not participate directly or indirectly in the discrimination prohibited by the Acts and the Regulations, including employment practices when the contract covers any activity, project, or program set forth in Appendix B of 49 CFR Part 21.
3. **Solicitations for Subcontracts, Including Procurements of Materials and Equipment:** In all solicitations, either by competitive bidding, or negotiation made by the contractor for work to be performed under a subcontract, including procurements of materials, or leases of equipment, each potential subcontractor or supplier will be notified by the contractor of the contractor's obligations under this contract and the Acts and the Regulations relative to Non-discrimination on the grounds of race, color, or national origin.
4. **Information and Reports:** The contractor will provide all information and reports required by the Acts, the Regulations, and directives issued pursuant thereto and will permit access to its books, records, accounts, other sources of information, and its facilities as may be determined by the Recipient or the **FHWA** to be pertinent to ascertain compliance with such Acts, Regulations, and instructions. Where any information required of a contractor is in the exclusive possession of another who fails or refuses to furnish the information, the contractor will so certify to the Recipient or the **FHWA** as appropriate, and will set forth what efforts it has made to obtain the information.
5. **Sanctions for Noncompliance:** In the event of a contractor's noncompliance with the Non-discrimination provisions of this contract, the Recipient will impose such contract sanctions as it or the **FHWA** may determine to be appropriate, including, but not limited to:

- a. withholding payments to the contractor under the contract until the contractor complies; and/or
 - b. cancelling, terminating, or suspending a contract, in whole or in part.
6. **Incorporation of Provisions:** The contractor will include the provisions of paragraphs one through six in every subcontract, including procurements of materials and leases of equipment, unless exempt by the Acts, the Regulations and directives issued pursuant thereto. The contractor will take action with respect to any subcontract or procurement as the Recipient or the FHWA may direct as a means of enforcing such provisions including sanctions for noncompliance. Provided, that if the contractor becomes involved in, or is threatened with litigation by a subcontractor, or supplier because of such direction, the contractor may request the Recipient to enter into any litigation to protect the interests of the Recipient. In addition, the contractor may request the United States to enter into the litigation to protect the interests of the United States.

APPENDIX B

CLAUSES FOR DEEDS TRANSFERRING UNITED STATES PROPERTY

The following clauses will be included in deeds effecting or recording the transfer of real property, structures, or improvements thereon, or granting interest therein from the United States pursuant to the provisions of Assurance 4:

NOW, THEREFORE, the U.S. Department of Transportation as authorized by law and upon the condition that the **Maine Department of Transportation** will accept title to the lands and maintain the project constructed thereon in accordance with all requirements imposed by Title 49, Code of Federal Regulations, Department of Transportation, subtitle A, Office of the Secretary, part 21, Non-discrimination in Federally-assisted Programs of the Department of Transportation pertaining to and effectuating the provisions of Title VI of the Civil Rights Act of 1964 (78 Stat. 252; 42 U.S.C. § 2000d to 2000d-4), the Regulations for the Administration of **Federal Highway Administration (FHWA) Program**, and the policies and procedures prescribed by the **FHWA** of the U.S. Department of Transportation in accordance and in compliance with all requirements imposed by Title 49, Code of Federal Regulations, U.S. Department of Transportation, Subtitle A, Office of the Secretary, Part 21, Non-discrimination in Federally-assisted programs of the U.S. Department of Transportation pertaining to and effectuating the provisions of Title VI of the Civil Rights Act of 1964 (78 Stat. 252; 42 U.S.C. § 2000d to 2000d-4), does hereby remise, release, quitclaim and convey unto the **Maine Department of Transportation** all the right, title and interest of the U.S. Department of Transportation in and to said lands described in Exhibit A attached hereto and made a part hereof.

(HABENDUM CLAUSE)

TO HAVE AND TO HOLD said lands and interests therein unto **Maine Department of Transportation** and its successors forever, subject, however, to the covenants, conditions, restrictions and reservations herein contained as follows, which will remain in effect for the period during which the real property or structures are used for a purpose for which Federal financial assistance is extended or for another purpose involving the provision of similar services or benefits and will be binding on the **Maine Department of Transportation**, its successors and assigns.

The **Maine Department of Transportation**, in consideration of the conveyance of said lands and interests in lands, does hereby covenant and agree as a covenant running with the land for itself, its successors and assigns, that (1) no person will on the grounds of race, color, or national origin, be excluded from participation in, be denied the benefits of, or be otherwise subjected to discrimination with regard to any facility located wholly or in part on, over, or under such lands hereby conveyed [,] [and]* (2) that the **Maine Department of Transportation** will use the lands and interests in lands and interests in lands so conveyed, in compliance with all requirements imposed by or pursuant to Title 49, Code of Federal Regulations, U.S. Department of Transportation, Subtitle A, Office of the Secretary, Part 21, Non-discrimination in Federally-assisted programs of the U.S. Department of Transportation, Effectuation of Title VI of the Civil Rights Act of 1964, and as said Regulations and Acts may be amended[, and (3) that in the event of breach of any of the above-mentioned non-discrimination conditions, the Department will have a right to enter or re-enter said lands and facilities on said land, and that above described land and facilities will thereon revert to and vest in and become the absolute property of the U.S. Department of Transportation

and its assigns as such interest existed prior to this instruction].*

(*Reverter clause and related language to be used only when it is determined that such a clause is necessary in order to make clear the purpose of Title VI.)

APPENDIX C

CLAUSES FOR TRANSFER OF REAL PROPERTY ACQUIRED OR IMPROVED UNDER THE ACTIVITY, FACILITY, OR PROGRAM

The following clauses will be included in deeds, licenses, leases, permits, or similar instruments entered into by the **Maine Department of Transportation** pursuant to the provisions of Assurance 7(a):

- A. The (grantee, lessee, permittee, etc. as appropriate) for himself/herself, his/her heirs, personal representatives, successors in interest, and assigns, as a part of the consideration hereof, does hereby covenant and agree [in the case of deeds and leases add "as a covenant running with the land"] that:
 1. In the event facilities are constructed, maintained, or otherwise operated on the property described in this (deed, license, lease, permit, etc.) for a purpose for which a U.S. Department of Transportation activity, facility, or program is extended or for another purpose involving the provision of similar services or benefits, the (grantee, licensee, lessee, permittee, etc.) will maintain and operate such facilities and services in compliance with all requirements imposed by the Acts and Regulations (as may be amended) such that no person on the grounds of race, color, or national origin, will be excluded from participation in, denied the benefits of, or be otherwise subjected to discrimination in the use of said facilities.
- B. With respect to licenses, leases, permits, etc., in the event of breach of any of the above Non-discrimination covenants, **Maine Department of Transportation** will have the right to terminate the (lease, license, permit, etc.) and to enter, re-enter, and repossess said lands and facilities thereon, and hold the same as if the (lease, license, permit, etc.) had never been made or issued.*
- C. With respect to a deed, in the event of breach of any of the above Non-discrimination covenants, the **Maine Department of Transportation** will have the right to enter or re-enter the lands and facilities thereon, and the above described lands and facilities will there upon revert to and vest in and become the absolute property of the **Maine Department of Transportation** and its assigns.*

(*Reverter clause and related language to be used only when it is determined that such a clause is necessary to make clear the purpose of Title VI.)

APPENDIX D

CLAUSES FOR CONSTRUCTION/USE/ACCESS TO REAL PROPERTY ACQUIRED UNDER THE ACTIVITY, FACILITY OR PROGRAM

The following clauses will be included in deeds, licenses, permits, or similar instruments/agreements entered into by **Maine Department of Transportation** pursuant to the provisions of Assurance 7(b):

- A. The (grantee, licensee, permittee, etc., as appropriate) for himself/herself, his/her heirs, personal representatives, successors in interest, and assigns, as a part of the consideration hereof, does hereby covenant and agree (in the case of deeds and leases add, "as a covenant running with the land") that (1) no person on the ground of race, color, or national origin, will be excluded from participation in, denied the benefits of, or be otherwise subjected to discrimination in the use of said facilities, (2) that in the construction of any improvements on, over, or under such land, and the furnishing of services thereon, no person on the ground of race, color, or national origin, will be excluded from participation in, denied the benefits of, or otherwise be subjected to discrimination, (3) that the (grantee, licensee, lessee, permittee, etc.) will use the premises in compliance with all other requirements imposed by or pursuant to the Acts and Regulations, as amended, set forth in this Assurance.
- B. With respect to (licenses, leases, permits, etc.), in the event of breach of any of the above Non-discrimination covenants, **Maine Department of Transportation** will have the right to terminate the (license, permit, etc., as appropriate) and to enter or re-enter and repossess said land and the facilities thereon, and hold the same as if said (license, permit, etc., as appropriate) had never been made or issued.*
- C. With respect to deeds, in the event of breach of any of the above Non-discrimination covenants, **Maine Department of Transportation** will there upon revert to and vest in and become the absolute property of **Maine Department of Transportation** and its assigns.*

(*Reverter clause and related language to be used only when it is determined that such a clause is necessary to make clear the purpose of Title VI.)

APPENDIX E

During the performance of this contract, the contractor, for itself, its assignees, and successors in interest (hereinafter referred to as the "contractor") agrees to comply with the following non-discrimination statutes and authorities; including but not limited to:

Pertinent Non-Discrimination Authorities:

- Title VI of the Civil Rights Act of 1964 (42 U.S.C. § 2000d *et seq.*, 78 stat. 252), (prohibits discrimination on the basis of race, color, national origin); and 49 CFR Part 21.
- The Uniform Relocation Assistance and Real Property Acquisition Policies Act of 1970, (42 U.S.C. § 4601), (prohibits unfair treatment of persons displaced or whose property has been acquired because of Federal or Federal-aid programs and projects);
- Federal-Aid Highway Act of 1973, (23 U.S.C. § 324 *et seq.*), (prohibits discrimination on the basis of sex);
- Section 504 of the Rehabilitation Act of 1973, (29 U.S.C. § 794 *et seq.*), as amended, (prohibits discrimination on the basis of disability); and 49 CFR Part 27;
- The Age Discrimination Act of 1975, as amended, (42 U.S.C. § 6101 *et seq.*), (prohibits discrimination on the basis of age);
- Airport and Airway Improvement Act of 1982, (49 USC § 471, Section 47123), as amended, (prohibits discrimination based on race, creed, color, national origin, or sex);
- The Civil Rights Restoration Act of 1987, (PL 100-209), (Broadened the scope, coverage and applicability of Title VI of the Civil Rights Act of 1964, The Age Discrimination Act of 1975 and Section 504 of the Rehabilitation Act of 1973, by expanding the definition of the terms "programs or activities" to include all of the programs or activities of the Federal-aid recipients, sub-recipients and contractors, whether such programs or activities are Federally funded or not);
- Titles II and III of the Americans with Disabilities Act, which prohibit discrimination on the basis of disability in the operation of public entities, public and private transportation systems, places of public accommodation, and certain testing entities (42 U.S.C. §§ 12131-12189) as implemented by Department of Transportation regulations at 49 C.F.R. parts 37 and 38;
- The Federal Aviation Administration's Non-discrimination statute (49 U.S.C. § 47123) (prohibits discrimination on the basis of race, color, national origin, and sex);
- Executive Order 12898, Federal Actions to Address Environmental Justice in Minority Populations and Low-Income Populations, which ensures discrimination against minority populations by discouraging programs, policies, and activities with disproportionately high and adverse human health or environmental effects on minority and low-income populations;
- Executive Order 13166, Improving Access to Services for Persons with Limited English Proficiency, and resulting agency guidance, national origin discrimination includes discrimination because of limited English proficiency (LEP). To ensure

compliance with Title VI, you must take reasonable steps to
-ensure that LEP persons have meaningful access to your programs (70 Fed. Reg. at
74087 to 74100);

- Title IX of the Education Amendments of 1972, as amended, which prohibits you from discriminating because of sex in education programs or activities (20 U.S.C. 1681 et seq).