

**Updated 04/28/17**

# **STATE PROJECT**

## BIDDING INSTRUCTIONS

### FOR ALL PROJECTS:

1. Use pen and ink to complete all paper Bids.
2. As a minimum, the following must be received prior to the time of Bid opening:

#### For a Paper Bid:

- a) a copy of the Notice to Contractors, b) the completed Acknowledgement of Bid Amendments form, c) the completed Schedule of Items, d) two copies of the completed and signed Contract Offer, Agreement & Award form, e) a Bid Guaranty, (if required), and f) any other certifications or Bid requirements listed in the Bid Documents as due by Bid opening.

#### For an Electronic Bid:

- a) a completed Bid using Expedite® software and submitted via the Bid Express™ web-based service, b) an electronic Bid Guaranty (if required) or a faxed copy of a Bid Bond (with original to be delivered within 72 hours), and c) any other Certifications or Bid requirements listed in the Bid Documents as due by Bid opening.
3. Include prices for all items in the Schedule of Items (excluding non-selected alternates).
4. Bid Guaranty acceptable forms are:
  - a) a properly completed and signed Bid Bond on the Department's prescribed form (or on a form that does not contain any significant variations from the Department's form as determined by the Department) for 5% of the Bid Amount or
  - b) an Official Bank Check, Cashier's Check, Certified Check, U.S. Postal Money Order or Negotiable Certificate of Deposit in the amount stated in the Notice to Contractors or
  - c) an electronic bid bond submitted with an electronic bid.
5. If a paper Bid is to be sent, "FedEx First Overnight" delivery is suggested as the package is delivered directly to the DOT Headquarters Building located at 16 Child Street in Augusta. Other means, such as U.S. Postal Service's Express Mail has proven not to be reliable.

### IN ADDITION, FOR FEDERAL AID PROJECTS:

6. Complete the DBE Proposed Utilization form, and submit with your bid. If you are submitting your bid electronically, you must FAX the form to (207) 624-3431. This is a curable defect.

*If you need further information regarding Bid preparation, call the DOT  
Contracts Section at (207) 624-3410.*

*For complete bidding requirements, refer to Section 102 of the Maine Department  
of Transportation, Standard Specifications, November 2014 Edition.*

# NOTICE

The Maine Department of Transportation is attempting to improve the way Bid Amendments/Addendums are handled, and allow for an electronic downloading of bid packages from our website, while continuing to maintain an optional plan holders list.

Prospective bidders, subcontractors or suppliers who wish to download a copy of the bid package and receive a courtesy notification of project specific bid amendments must fill out the on-line plan holder registration form and provide an email address to the MDOT Contracts mailbox at: [MDOT.contracts@maine.gov](mailto:MDOT.contracts@maine.gov). Each bid package will require a separate request.

Additionally, interested parties will be responsible for reviewing and retrieving the Bid Amendments from our web site, and acknowledging receipt and incorporating those Bid Amendments in their bids using the Acknowledgement of Bid Amendment Form.

The downloading of bid packages from the MDOT website is not the same as providing an electronic bid to the Department. Electronic bids must be submitted via <http://www.BIDX.com>. For information on electronic bidding contact Rebecca Snowden at [rebecca.snowden@maine.gov](mailto:rebecca.snowden@maine.gov) or Diane Barnes at [diane.barnes@maine.gov](mailto:diane.barnes@maine.gov).

# NOTICE

For security and other reasons, all Bid Packages which are mailed, shall be provided in double (one envelope inside the other) envelopes. The *Inner Envelope* shall have the following information provided on it:

Bid Enclosed - Do Not Open

PIN:

Town:

Date of Bid Opening:

Name of Contractor with mailing address and telephone number:

In Addition to the usual address information, the *Outer Envelope* should have written or typed on it:

Double Envelope: Bid Enclosed

PIN:

Town:

Date of Bid Opening:

Name of Contractor:

*This should not be much of a change for those of you who use Federal Express or similar services.*

Hand-carried Bids may be in one envelope as before, and should be marked with the following information:

Bid Enclosed: Do Not Open

PIN:

Town:

Name of Contractor:

October 16, 2001

**STATE OF MAINE DEPARTMENT OF TRANSPORTATION**  
Bid Guaranty-Bid Bond Form

**KNOW ALL MEN BY THESE PRESENTS THAT** \_\_\_\_\_

\_\_\_\_\_, of the City/Town of \_\_\_\_\_ and State of \_\_\_\_\_

as Principal, and \_\_\_\_\_ as Surety, a

Corporation duly organized under the laws of the State of \_\_\_\_\_ and having a usual place of

Business in \_\_\_\_\_ and hereby held and firmly bound unto the Treasurer of

the State of Maine in the sum of \_\_\_\_\_ for payment which Principal and Surety bind

themselves, their heirs, executors, administrators, successors and assigns, jointly and severally.

The condition of this obligation is that the Principal has submitted to the Maine Department of

Transportation, hereafter Department, a certain bid, attached hereto and incorporated as a

part herein, to enter into a written contract for the construction of \_\_\_\_\_

\_\_\_\_\_ and if the Department shall accept said bid

and the Principal shall execute and deliver a contract in the form attached hereto (properly

completed in accordance with said bid) and shall furnish bonds for this faithful performance of

said contract, and for the payment of all persons performing labor or furnishing material in

connection therewith, and shall in all other respects perform the agreement created by the

acceptance of said bid, then this obligation shall be null and void; otherwise it shall remain in full

force, and effect.

Signed and sealed this \_\_\_\_\_ day of \_\_\_\_\_ 20\_\_\_\_\_

WITNESS:

\_\_\_\_\_

\_\_\_\_\_

\_\_\_\_\_

WITNESS

\_\_\_\_\_

\_\_\_\_\_

\_\_\_\_\_

PRINCIPAL:

By \_\_\_\_\_

By: \_\_\_\_\_

By: \_\_\_\_\_

SURETY:

By \_\_\_\_\_

By: \_\_\_\_\_

Name of Local Agency: \_\_\_\_\_

# NOTICE

Bidders:

Please use the attached “Request for Information” form when submitting questions concerning specific Contracts that have been advertised for Bid, include additional numbered pages as required. RFI’s may be faxed to 207-624-3431, submitted electronically through the Departments web page of advertised projects by selecting the RFI tab on the project details page or via e-mail to [RFI-Contracts.MDOT@maine.gov](mailto:RFI-Contracts.MDOT@maine.gov).

These are the only allowable mechanisms for answering Project specific questions. Maine DOT will not be bound to any answers to Project specific questions received during the Bidding phase through other processes.

When submitting RFIs by Email please follow the same guidelines as stated on the “Request for Information” form and include the word “RFI” along with the Project name and Identification number in the subject line.



### **Vendor Registration**

Prospective Bidders must register as a vendor with the Department of Administrative & Financial Services if the vendor is awarded a contract. Vendors will not be able to receive payment without first being registered. Vendors/Contractors will find information and register through the following link –

<http://www.maine.gov/purchases/venbid/index.shtml>

**STATE OF MAINE DEPARTMENT OF TRANSPORTATION  
NOTICE TO CONTRACTORS**

Sealed Bids addressed to the Maine Department of Transportation, Augusta, Maine 04333 and endorsed on the wrapper "Bids for Cyclical Pavement Resurfacing with Safety Improvements in the Towns of Randolph and Chelsea" will be received from contractors at the Reception Desk, MaineDOT Building, Capitol Street, Augusta, Maine, until 11:00 o'clock A.M. (prevailing time) on April 4, 2018 and at that time and place publicly opened and read. Bids will be accepted from all bidders. The lowest responsive bidder must have completed, or successfully complete, a Highway Construction, Paving, or project specific prequalification to be considered for the award of this contract. **We now accept electronic bids for those bid packages posted on the bidx.com website. Electronic bids do not have to be accompanied by paper bids. Please note: The Department will accept a facsimile of the bid bond; however, the original bid bond must then be received at the MDOT Contract Section within 72 hours of the bid opening.** Until further notice, dual bids (one paper, one electronic) will be accepted, with the paper copy taking precedence.

Description: 023398.00, WIN 23398.00.

Location: In Kennebec County, project is located in Randolph beginning at Water Street and extending northeast 5.50 miles to Eastern Avenue in Chelsea.

Outline of Work: Cyclical Pavement Resurfacing with Safety Improvements and other incidental work.

For general information regarding Bidding and Contracting procedures, contact George Macdougall at (207) 624-3410. Our webpage at <http://www.maine.gov/mdot/contractors/> contains a copy of the Schedule of Items, Plan Holders List, written portions of bid amendments, drawings, bid results and an electronic form for RFI submittal. For Project-specific information fax all questions to **Scott Bickford** at (207) 624-3431, use electronic RFI form or email questions to [RFI-Contracts.MDOT@maine.gov](mailto:RFI-Contracts.MDOT@maine.gov), project name and identification number should be in the subject line. Questions received after 12:00 noon of Monday (or if that Monday is a state holiday, Friday) prior to bid date will not be answered. Bidders shall not contact any other Departmental staff for clarification of Contract provisions, and the Department will not be responsible for any interpretations so obtained. TTY users call Maine Relay 711.

Specifications and bid forms may be seen at the MaineDOT Building in Augusta, Maine and at the Department of Transportation's Regional Office in Augusta. They may be purchased from the Department between the hours of 8:00 a.m. to 4:30 p.m. by cash, credit card (Visa/Mastercard) or check payable to Treasurer, State of Maine sent to Maine Department of Transportation, Attn.: Mailroom, 16 State House Station, Augusta, Maine 04333-0016. They also may be purchased by telephone at (207) 624-3536 between the hours of 8:00 a.m. to 4:30 p.m. Bid Book \$10 (\$13 by mail), payment in advance, all non-refundable.

Each Bid must be made upon blank forms provided by the Department and must be accompanied by a bid bond at 5% of the bid amount or an official bank check, cashier's check, certified check, certificate of deposit, or United States postal money order in the amount of **\$25,000** payable to Treasurer, State of Maine as a Bid guarantee. A Contract Performance Surety Bond and a Contract Payment Surety Bond, each in the amount of 100 percent of the Contract price, will be required of the successful Bidder.

This Contract is subject to all applicable State Laws.

All work shall be governed by "State of Maine, Department of Transportation, Standard Specifications, November 2014 Edition," price \$10 [\$15 by mail], and "Standard Details, November 2014 Edition," price \$10 [\$15 by mail]. They also may be purchased by telephone at (207) 624-3536 between the hours of 8:00 a.m. to 4:30 p.m. Standard Detail updates can be found at <http://www.maine.gov/mdot/contractors/publications/>.

The right is hereby reserved to the MaineDOT to reject any or all bids.

Augusta, Maine  
March 14, 2018

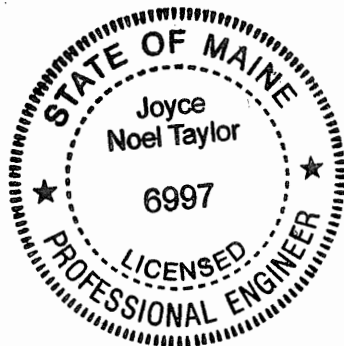

A handwritten signature in black ink that reads "Joyce Noel Taylor".

JOYCE NOEL TAYLOR P. E.  
CHIEF ENGINEER

# NOTICE

All bids for Federal Projects **shall** be accompanied by the DBE Proposed Utilization form. If you are submitting an electronic bid, the DBE Utilization Form may be faxed to 207-624-3431. Failure to submit the form with the bid will be considered a curable defect.

**SPECIAL PROVISION 102.7.3**  
**ACKNOWLEDGMENT OF BID AMENDMENTS**

With this form, the Bidder acknowledges its responsibility to check for all Amendments to the Bid Package. For each Project under Advertisement, Amendments are located at <http://www.maine.gov/mdot/contractors/> . It is the responsibility of the Bidder to determine if there are Amendments to the Project, to download them, to incorporate them into their Bid Package, and to reference the Amendment number and the date on the form below. The Maine DOT will not post Bid Amendments any later than noon the day before Bid opening without individually notifying all the planholders.

Amendment Number	Date

The Contractor, for itself, its successors and assigns, hereby acknowledges that it has received all of the above referenced Amendments to the Bid Package.

**CONTRACTOR**

\_\_\_\_\_  
Date

\_\_\_\_\_  
Signature of authorized representative

\_\_\_\_\_  
(Name and Title Printed)

Maine Department of Transportation

Proposal Schedule of Items

Proposal ID: 023398.00

Project(s): 023398.00

SECTION: 1 HIGHWAY ITEMS

Alt Set ID: Alt Mbr ID:

Contractor: \_\_\_\_\_

Proposal Line Number	Item ID Description	Approximate Quantity and Units	Unit Price		Bid Amount	
			Dollars	Cents	Dollars	Cents
0010	202.203 PAVEMENT BUTT JOINTS	2,025.000 SY	_____	 _____	_____	 _____
0020	403.209 HOT MIX ASPHALT 9.5 MM (SIDEWALKS, DRIVES, INCIDENTALS)	160.000 T	_____	 _____	_____	 _____
0030	403.211 HOT MIX ASPHALT (SHIMMING)	2,175.000 T	_____	 _____	_____	 _____
0040	409.15 BITUMINOUS TACK COAT - APPLIED	4,900.000 G	_____	 _____	_____	 _____
0050	461.210 9.5 MM HMA - CYCLICAL PAVEMENT RESURFACING	4,451.000 T	_____	 _____	_____	 _____
0060	604.18 ADJUSTING MANHOLE OR CATCH BASIN TO GRADE	13.000 EA	_____	 _____	_____	 _____
0070	606.231 GUARDRAIL TYPE 3C - 15 FOOT RADIUS AND LESS	12.500 LF	_____	 _____	_____	 _____
0080	608.26 CURB RAMP DETECTABLE WARNING FIELD	60.000 SF	_____	 _____	_____	 _____
0090	608.45 CONSTRUCT SIDEWALK	47.000 SY	_____	 _____	_____	 _____
0100	609.31 CURB TYPE 3	440.000 LF	_____	 _____	_____	 _____
0110	613.319 EROSION CONTROL BLANKET	2,500.000 SY	_____	 _____	_____	 _____
0120	618.14 SEEDING METHOD NUMBER 2	125.000 UN	_____	 _____	_____	 _____

## Maine Department of Transportation

## Proposal Schedule of Items

Proposal ID: 023398.00

Project(s): 023398.00

SECTION: 1 HIGHWAY ITEMS

Alt Set ID:

Alt Mbr ID:

Contractor: \_\_\_\_\_

Proposal Line Number	Item ID Description	Approximate Quantity and Units	Unit Price		Bid Amount	
			Dollars	Cents	Dollars	Cents
0130	619.12 MULCH	125.000 UN	_____	 _____	_____	 _____
0140	627.75 WHITE OR YELLOW PAVEMENT & CURB MARKING	501.000 SF	_____	 _____	_____	 _____
0150	627.78 TEMPORARY 4 INCH PAINTED PAVEMENT MARKING LINE, WHITE OR YELLOW	115,155.000 LF	_____	 _____	_____	 _____
0160	629.05 HAND LABOR, STRAIGHT TIME	30.000 HR	_____	 _____	_____	 _____
0170	631.12 ALL PURPOSE EXCAVATOR (INCLUDING OPERATOR)	100.000 HR	_____	 _____	_____	 _____
0180	631.172 TRUCK - LARGE (INCLUDING OPERATOR)	200.000 HR	_____	 _____	_____	 _____
0190	652.34 CONE	220.000 EA	_____	 _____	_____	 _____
0200	652.35 CONSTRUCTION SIGNS	1,110.000 SF	_____	 _____	_____	 _____
0210	652.36 MAINTENANCE OF TRAFFIC CONTROL DEVICES	44.000 CD	_____	 _____	_____	 _____
0220	652.38 FLAGGER	550.000 HR	_____	 _____	_____	 _____
0230	656.75 TEMPORARY SOIL EROSION AND WATER POLLUTION CONTROL	LUMP SUM		 LUMP SUM	_____	 _____

Maine Department of Transportation

Proposal Schedule of Items

Proposal ID: 023398.00

Project(s): 023398.00

SECTION: 1 HIGHWAY ITEMS

Alt Set ID: Alt Mbr ID:

Contractor: \_\_\_\_\_

Proposal Line Number	Item ID Description	Approximate Quantity and Units	Unit Price		Bid Amount	
			Dollars	Cents	Dollars	Cents
0240	659.10 MOBILIZATION	LUMP SUM	LUMP SUM		_____	_____
0250	812.162 ADJUSTING SEWER MANHOLE TO GRADE	10.000 EA	_____	_____	_____	_____
0260	812.163 MODIFY SEWER MH, ADJUST FRAME & COVER	18.000 EA	_____	_____	_____	_____
0270	812.164 REBUILDING SEWER MANHOLE	9.000 EA	_____	_____	_____	_____
Section: 1			Total:		_____	_____
			Total Bid:		_____	_____

## CONTRACT AGREEMENT, OFFER & AWARD

AGREEMENT made on the date last signed below, by and between the State of Maine, acting through and by its Department of Transportation (Department), an agency of state government with its principal administrative offices located at Child Street, Augusta, Maine, with a mailing address at 16 State House Station, Augusta, Maine 04333-0016, and \_\_\_\_\_ a corporation or other legal entity organized under the laws of the State of \_\_\_\_\_, with its principal place of business located at \_\_\_\_\_

The Department and the Contractor, in consideration of the mutual promises set forth in this Agreement (the "Contract"), hereby agree as follows:

### **A. The Work.**

The Contractor agrees to complete all Work as specified or indicated in the Contract including Extra Work in conformity with the Contract, **WIN 23398.00 for the Cyclical Pavement Resurfacing with Safety Improvements, Towns of Randolph and Chelsea, County of Kennebec, Maine.** The Work includes construction, maintenance during construction, warranty as provided in the Contract, and other incidental work.

The Contractor shall be responsible for furnishing all supervision, labor, equipment, tools supplies, permanent materials and temporary materials required to perform the Work including construction quality control including inspection, testing and documentation, all required documentation at the conclusion of the project, warranting its work and performing all other work indicated in the Contract.

The Department shall have the right to alter the nature and extent of the Work as provided in the Contract; payment to be made as provided in the same.

### **B. Time.**

The Contractor agrees to complete all Work, except warranty work, on or before **September 22, 2018.** Further, the Department may deduct from moneys otherwise due the Contractor, not as a penalty, but as Liquidated Damages in accordance with Sections 107.7 and 107.8 of the State of Maine Department of Transportation "Standard Specifications, November 2014 Edition" and related Special Provisions.

**C. Price.**

The quantities given in the Schedule of Items of the Bid Package will be used as the basis for determining the original Contract amount and for determining the amounts of the required Performance Surety Bond and Payment Surety Bond, and that the amount of this offer is \_\_\_\_\_

\_\_\_\_\_ Performance Bond and Payment Bond each being 100% of the amount of this Contract.

**D. Contract.**

This Contract, which may be amended, modified, or supplemented in writing only, consists of the Contract documents as defined in the Plans, Standard Specifications, November 2014 Edition, Standard Details November 2014 Edition as updated through advertisement, Supplemental Specifications, Special Provisions, Contract Agreement; and Contract Bonds. It is agreed and understood that this Contract will be governed by the documents listed above.

**E. Certifications.**

By signing below, the Contractor hereby certifies that to the best of the Contractor's knowledge and belief:

1. All of the statements, representations, covenants, and/or certifications required or set forth in the Bid and the Bid Documents, including those in the Contract are still complete and accurate as of the date of this Agreement.
2. The Contractor knows of no legal, contractual, or financial impediment to entering into this Contract.
3. The person signing below is legally authorized by the Contractor to sign this Contract on behalf of the Contractor and to legally bind the Contractor to the terms of the Contract.

**F. Offer.**

The undersigned, having carefully examined the site of work, the Plans, Standard Specifications November 2014 Edition, Standard Details November 2014 Edition as updated through advertisement, Supplemental Specifications, Special Provisions, Contract Agreement; and Contract Bonds contained herein for construction of: **WIN 23398.00 for the Cyclical Pavement Resurfacing with Safety Improvements, Towns of Randolph and Chelsea, County of Kennebec**, State of Maine, on which bids will be received until the time specified in the “Notice to Contractors” do(es) hereby bid and offer to enter into this contract to supply all the materials, tools, equipment and labor to construct the whole of the Work in strict accordance with the terms and conditions of this Contract at the unit prices in the attached “Schedule of Items”.

The Offeror agrees to perform the work required at the price specified above and in accordance with the bids provided in the attached “Schedule of Items” in strict accordance with the terms of this solicitation, and to provide the appropriate insurance and bonds if this offer is accepted by the Government in writing.

As Offeror also agrees:

First: To do any extra work, not covered by the attached “Schedule of Items”, which may be ordered by the Resident, and to accept as full compensation the amount determined upon a “Force Account” basis as provided in the Standard Specifications, November 2014 Edition, and as addressed in the contract documents.

Second: That the bid bond at 5% of the bid amount or the official bank check, cashier’s check, certificate of deposit or U. S. Postal Money Order in the amount given in the “Notice to Contractors”, payable to the Treasurer of the State of Maine and accompanying this bid, shall be forfeited, as liquidated damages, if in case this bid is accepted, and the undersigned shall fail to abide by the terms and conditions of the offer and fail to furnish satisfactory insurance and Contract bonds under the conditions stipulated in the Specifications within 15 days of notice of intent to award the contract.

Third: To begin the Work as stated in Section 107.2 of the Standard Specifications November 2014 Edition and complete the Work within the time limits given in the Special Provisions of this Contract.

Fourth: That this offer shall remain open for 30 calendar days after the date of opening of bids.

Fifth: The Bidder hereby certifies, to the best of its knowledge and belief that: the Bidder has not, either directly or indirectly, entered into any agreement, participated in any collusion, or otherwise taken any action in restraint of competitive bidding in connection with its bid, and its subsequent contract with the Department.

IN WITNESS WHEREOF, the Contractor, for itself, its successors and assigns, hereby execute two duplicate originals of this Agreement and thereby binds itself to all covenants, terms, and obligations contained in the Contract Documents.

CONTRACTOR

\_\_\_\_\_

Date

\_\_\_\_\_  
(Signature of Legally Authorized Representative  
of the Contractor)

\_\_\_\_\_

Witness

\_\_\_\_\_  
(Name and Title Printed)

**G. Award.**

Your offer is hereby accepted.  
documents referenced herein.

This award consummates the Contract, and the

MAINE DEPARTMENT OF TRANSPORTATION

\_\_\_\_\_

Date

\_\_\_\_\_  
By: David Bernhardt, Commissioner

\_\_\_\_\_

Witness

## **CONTRACT AGREEMENT, OFFER & AWARD**

AGREEMENT made on the date last signed below, by and between the State of Maine, acting through and by its Department of Transportation (Department), an agency of state government with its principal administrative offices located at Child Street, Augusta, Maine, with a mailing address at 16 State House Station, Augusta, Maine 04333-0016, and \_\_\_\_\_ a corporation or other legal entity organized under the laws of the State of \_\_\_\_\_, with its principal place of business located at \_\_\_\_\_

The Department and the Contractor, in consideration of the mutual promises set forth in this Agreement (the "Contract"), hereby agree as follows:

### **A. The Work.**

The Contractor agrees to complete all Work as specified or indicated in the Contract including Extra Work in conformity with the Contract, **WIN 23398.00 for the Cyclical Pavement Resurfacing with Safety Improvements, Towns of Randolph and Chelsea, County of Kennebec, Maine.** The Work includes construction, maintenance during construction, warranty as provided in the Contract, and other incidental work.

The Contractor shall be responsible for furnishing all supervision, labor, equipment, tools supplies, permanent materials and temporary materials required to perform the Work including construction quality control including inspection, testing and documentation, all required documentation at the conclusion of the project, warranting its work and performing all other work indicated in the Contract.

The Department shall have the right to alter the nature and extent of the Work as provided in the Contract; payment to be made as provided in the same.

### **B. Time.**

The Contractor agrees to complete all Work, except warranty work, on or before **September 22, 2018.** Further, the Department may deduct from moneys otherwise due the Contractor, not as a penalty, but as Liquidated Damages in accordance with Sections 107.7 and 107.8 of the State of Maine Department of Transportation "Standard Specifications, November 2014 Edition" and related Special Provisions.

**C. Price.**

The quantities given in the Schedule of Items of the Bid Package will be used as the basis for determining the original Contract amount and for determining the amounts of the required Performance Surety Bond and Payment Surety Bond, and that the amount of this offer is \_\_\_\_\_

\_\_\_\_\_ \$ \_\_\_\_\_ Performance Bond and Payment Bond each being 100% of the amount of this Contract.

**D. Contract.**

This Contract, which may be amended, modified, or supplemented in writing only, consists of the Contract documents as defined in the Plans, Standard Specifications, November 2014 Edition, Standard Details November 2014 Edition as updated through advertisement, Supplemental Specifications, Special Provisions, Contract Agreement; and Contract Bonds. It is agreed and understood that this Contract will be governed by the documents listed above.

**E. Certifications.**

By signing below, the Contractor hereby certifies that to the best of the Contractor's knowledge and belief:

1. All of the statements, representations, covenants, and/or certifications required or set forth in the Bid and the Bid Documents, including those in the Contract are still complete and accurate as of the date of this Agreement.
2. The Contractor knows of no legal, contractual, or financial impediment to entering into this Contract.
3. The person signing below is legally authorized by the Contractor to sign this Contract on behalf of the Contractor and to legally bind the Contractor to the terms of the Contract.

**F. Offer.**

The undersigned, having carefully examined the site of work, the Plans, Standard Specifications November 2014 Edition, Standard Details November 2014 Edition as updated through advertisement, Supplemental Specifications, Special Provisions, Contract Agreement; and Contract Bonds contained herein for construction of: **WIN 23398.00 for the Cyclical Pavement Resurfacing with Safety Improvements, Towns of Randolph and Chelsea, County of Kennebec**, State of Maine, on which bids will be received until the time specified in the “Notice to Contractors” do(es) hereby bid and offer to enter into this contract to supply all the materials, tools, equipment and labor to construct the whole of the Work in strict accordance with the terms and conditions of this Contract at the unit prices in the attached “Schedule of Items”.

The Offeror agrees to perform the work required at the price specified above and in accordance with the bids provided in the attached “Schedule of Items” in strict accordance with the terms of this solicitation, and to provide the appropriate insurance and bonds if this offer is accepted by the Government in writing.

As Offeror also agrees:

First: To do any extra work, not covered by the attached “Schedule of Items”, which may be ordered by the Resident, and to accept as full compensation the amount determined upon a “Force Account” basis as provided in the Standard Specifications, November 2014 Edition, and as addressed in the contract documents.

Second: That the bid bond at 5% of the bid amount or the official bank check, cashier’s check, certificate of deposit or U. S. Postal Money Order in the amount given in the “Notice to Contractors”, payable to the Treasurer of the State of Maine and accompanying this bid, shall be forfeited, as liquidated damages, if in case this bid is accepted, and the undersigned shall fail to abide by the terms and conditions of the offer and fail to furnish satisfactory insurance and Contract bonds under the conditions stipulated in the Specifications within 15 days of notice of intent to award the contract.

Third: To begin the Work as stated in Section 107.2 of the Standard Specifications November 2014 Edition and complete the Work within the time limits given in the Special Provisions of this Contract.

Fourth: That this offer shall remain open for 30 calendar days after the date of opening of bids.

Fifth: The Bidder hereby certifies, to the best of its knowledge and belief that: the Bidder has not, either directly or indirectly, entered into any agreement, participated in any collusion, or otherwise taken any action in restraint of competitive bidding in connection with its bid, and its subsequent contract with the Department.

IN WITNESS WHEREOF, the Contractor, for itself, its successors and assigns, hereby execute two duplicate originals of this Agreement and thereby binds itself to all covenants, terms, and obligations contained in the Contract Documents.

CONTRACTOR

\_\_\_\_\_

Date

\_\_\_\_\_  
(Signature of Legally Authorized Representative  
of the Contractor)

\_\_\_\_\_

Witness

\_\_\_\_\_  
(Name and Title Printed)

**G. Award.**

Your offer is hereby accepted.  
documents referenced herein.

This award consummates the Contract, and the

MAINE DEPARTMENT OF TRANSPORTATION

\_\_\_\_\_

Date

\_\_\_\_\_  
By: David Bernhardt, Commissioner

\_\_\_\_\_

Witness

## CONTRACT AGREEMENT, OFFER & AWARD

AGREEMENT made on the date last signed below, by and between the State of Maine, acting through and by its Department of Transportation (Department), an agency of state government with its principal administrative offices located at Child Street Augusta, Maine, with a mailing address at 16 State House Station, Augusta, Maine 04333-0016, and  
(Name of the firm bidding the job)  
a corporation or other legal entity organized under the laws of the State of Maine, with its principal place of business located at (address of the firm bidding the job)

The Department and the Contractor, in consideration of the mutual promises set forth in this Agreement (the "Contract"), hereby agree as follows:

**A. The Work.**

The Contractor agrees to complete all Work as specified or indicated in the Contract including Extra Work in conformity with the Contract, PIN No. **1224.00**, for the **Hot Mix Asphalt Overlay** in the town/city of **South Nowhere**, County of **Washington**, Maine. The Work includes construction, maintenance during construction, warranty as provided in the Contract, and other incidental work.

The Contractor shall be responsible for furnishing all supervision, labor, equipment, tools supplies, permanent materials and temporary materials required to perform the Work including construction quality control including inspection, testing and documentation, all required documentation at the conclusion of the project, warranting its work and performing all other work indicated in the Contract.

The Department shall have the right to alter the nature and extent of the Work as provided in the Contract; payment to be made as provided in the same.

**B. Time.**

The Contractor agrees to complete all Work, except warranty work, on or before **November 15, 2006**. Further, the Department may deduct from moneys otherwise due the Contractor, not as a penalty, but as Liquidated Damages in accordance with Sections 107.7 and 107.8 of the State of Maine Department of Transportation Standard Specifications, Revision of December 2002 and related Special Provisions.

**C. Price.**

The quantities given in the Schedule of Items of the Bid Package will be used as the basis for determining the original Contract amount and for determining the amounts of the required Performance Surety Bond and Payment Surety Bond, and that the amount of this offer is           (Place bid here in alphabetical form such as One Hundred and Two dollars and 10 cents)            
\$ (repeat bid here in numerical terms, such as \$102.10) Performance Bond and Payment Bond each being 100% of the amount of this Contract.

**D. Contract.**

This Contract, which may be amended, modified, or supplemented in writing only, consists of the Contract documents as defined in the Plans, Standard Specifications, Revision of December 2002, Standard Details Revision of December 2002, Supplemental Specifications, Special Provisions, Contract Agreement; and Contract Bonds. It is agreed and understood that this Contract will be governed by the documents listed above.

**E. Certifications.**

By signing below, the Contractor hereby certifies that to the best of the Contractor's knowledge and belief:

1. All of the statements, representations, covenants, and/or certifications required or set forth in the Bid and the Bid Documents, including those in Appendix A to Division 100 of the Standard Specifications Revision of December 2002 (Federal Contract Provisions Supplement), and the Contract are still complete and accurate as of the date of this Agreement.
2. The Contractor knows of no legal, contractual, or financial impediment to entering into this Contract.
3. The person signing below is legally authorized by the Contractor to sign this Contract on behalf of the Contractor and to legally bind the Contractor to the terms of the Contract.

**F. Offer.**

The undersigned, having carefully examined the site of work, the Plans, Standard Specifications, Revision of December 2002, Standard Details Revision of December 2002, Supplemental Specifications, Special Provisions, Contract Agreement; and Contract Bonds contained herein for construction of:

**PIN 1234.00 South Nowhere, Hot Mix Asphalt Overlay**,

State of Maine, on which bids will be received until the time specified in the "Notice to Contractors" do(es) hereby bid and offer to enter into this contract to supply all the materials, tools, equipment and labor to construct the whole of the Work in strict accordance with the terms and conditions of this Contract at the unit prices in the attached "Schedule of Items".

The Offeror agrees to perform the work required at the price specified above and in accordance with the bids provided in the attached "Schedule of Items" in strict accordance with the terms of this solicitation, and to provide the appropriate insurance and bonds if this offer is accepted by the Government in writing.

As Offeror also agrees:

First: To do any extra work, not covered by the attached "Schedule of Items", which may be ordered by the Resident, and to accept as full compensation the amount determined upon a "Force Account" basis as provided in the Standard Specifications, Revision of December 2002, and as addressed in the contract documents.

Second: That the bid bond at 5% of the bid amount or the official bank check, cashier's check, certificate of deposit or U. S. Postal Money Order in the amount given in the "Notice to Contractors", payable to the Treasurer of the State of Maine and accompanying this bid, shall be forfeited, as liquidated damages, if in case this bid is accepted, and the undersigned shall fail to abide by the terms and conditions of the offer and fail to furnish satisfactory insurance and Contract bonds under the conditions stipulated in the Specifications within 15 days of notice of intent to award the contract.

Third: To begin the Work as stated in Section 107.2 of the Standard Specifications Revision of 2002 and complete the Work within the time limits given in the Special Provisions of this Contract.

Fourth: The Contractor will be bound to the Disadvantaged Business Enterprise (DBE) Requirements contained in the attached Notice (Additional Instructions to Bidders) and submit a completed Contractor's Disadvantaged Business Enterprise Utilization Plan with their bid.

Fifth: That this offer shall remain open for 30 calendar days after the date of opening of bids.

Sixth: The Bidder hereby certifies, to the best of its knowledge and belief that: the Bidder has not, either directly or indirectly, entered into any agreement, participated in any collusion, or otherwise taken any action in restraint of competitive bidding in connection with its bid, and its subsequent contract with the Department.

IN WITNESS WHEREOF, the Contractor, for itself, its successors and assigns, hereby execute two duplicate originals of this Agreement and thereby binds itself to all covenants, terms, and obligations contained in the Contract Documents.

\_\_\_\_\_  
Date

\_\_\_\_\_  
**(Witness Sign Here)**  
Witness

\_\_\_\_\_  
**(Sign Here)**  
(Signature of Legally Authorized Representative of the Contractor)

\_\_\_\_\_  
**(Print Name Here)**  
(Name and Title Printed)

CONTRACTOR

**G. Award.**

Your offer is hereby accepted.

This award consummates the Contract, and the documents referenced herein.

MAINE DEPARTMENT OF TRANSPORTATION

\_\_\_\_\_  
Date

\_\_\_\_\_  
By: David Bernhardt, Commissioner

\_\_\_\_\_  
(Witness)

STATE OF MAINE  
DEPARTMENT OF TRANSPORTATION



**RANDOLPH-CHELSEA**

KENNEBEC COUNTY

ROUTE 226

STATE PROJECT NO. 0233398.00

PROJECT LENGTH : 5.50 MILES



Scale in Miles  
0 1 2  
LOCATION MAP

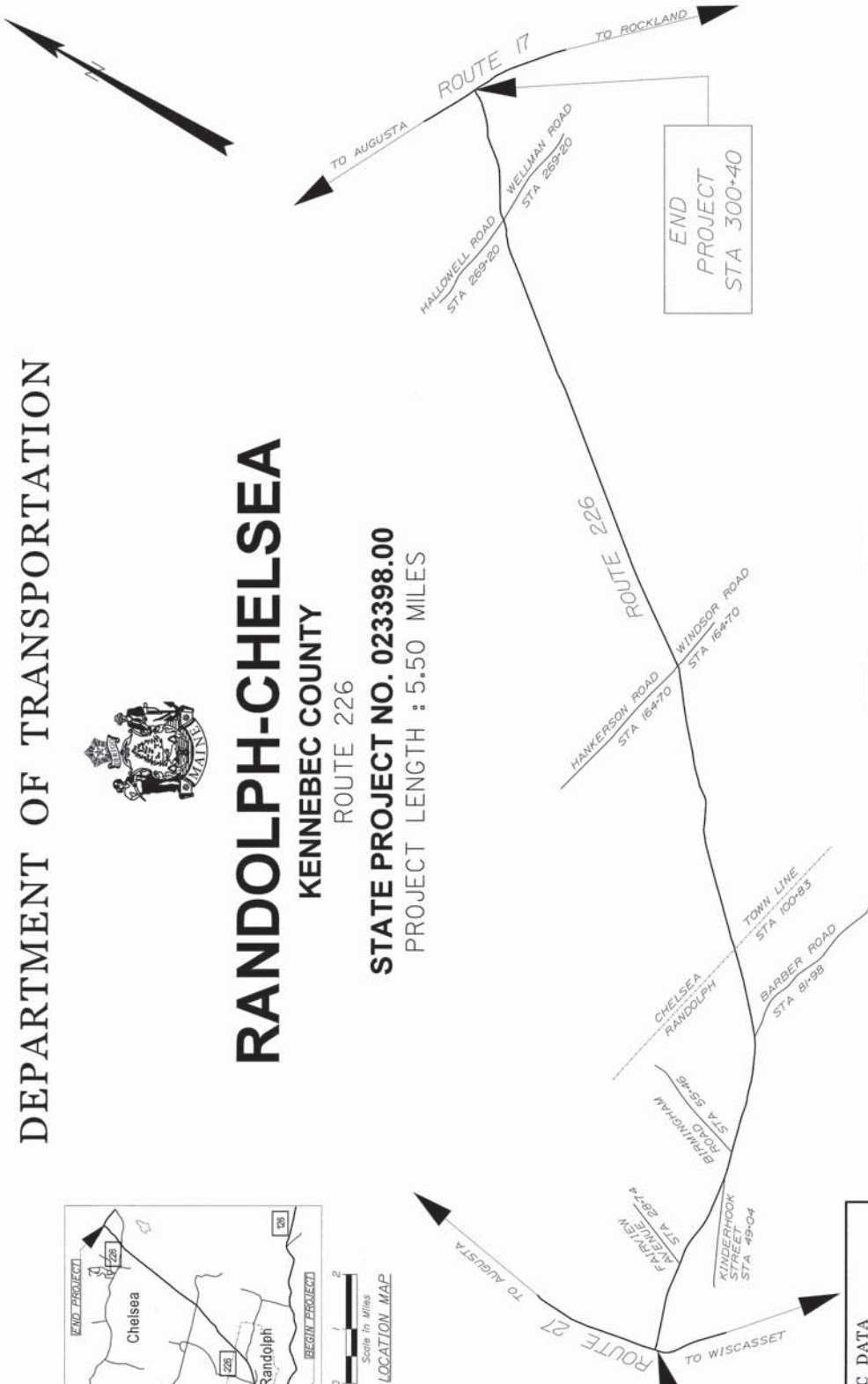

**TRAFFIC DATA**  
SR 226 E/O SR 27/126

Current (2018) AADT	6710
Future (2030) AADT	7520
DRV - % of AADT	10%
Decks - % of AADT	10%
% Heavy Trucks (AADT)	5%
% Heavy Trucks (DHV)	4%
Directional Distribution (DHV)	60%
18 kip Equivalent P 2.0	193
18 kip Equivalent P 2.5	184
Design Speed (mph)	45
Functional Class	Major Urban Coll
Corridor Priority	3

<b>PROJECT LOCATION:</b>	BEGINNING AT WATER STREET (ROUTE 27) AND EXTENDING NORTHEASTERLY 5.50 MILES TO EASTERN AVENUE (ROUTE 17).
<b>PROGRAM AREA:</b>	HIGHWAY PROGRAM
<b>SCOPE OF WORK:</b>	3/4" HOT MIX ASPHALT CYCLICAL PAVEMENT RESURFACING WITH MINIMUM SPOT SHIMS.

STATE OF MAINE  
DEPARTMENT OF TRANSPORTATION

APPROVED

DATE

COMMISSIONER

CHIEF ENGINEER

STATE OF MAINE PROFESSIONAL ENGINEER

DATE

P.E. NUMBER

SIGNATURE

PROJECT INFORMATION

PROGRAM

PROJECT MANAGER

PROJECT NUMBER

CONTRACT DATE

RANDOLPH-CHELSEA  
ROUTE 226

TITLE SHEET

SHEET NUMBER

1

OF 1

PROJ. MANAGER	DATE
DESIGNED BY	DATE
CHECKED BY	DATE
IN CHARGE	DATE
REVISIONS 1	
REVISIONS 2	
REVISIONS 3	
REVISIONS 4	

DATE	BY
DATE	BY
DATE	BY
DATE	BY

NOTE:

1. THE PAVEMENT DEPTHS AS SHOWN ON THE PLANS ARE INTENDED TO BE NOMINAL.
2. WHEN SUPERELEVATION EXCEEDS THE SLOPE OF THE LOW SIDE, THE MINIMUM SLOPE OF THE SHOULDER SHALL MAKE THE SAME SLOPE AS THE TRAVELWAY.
3. CROWNS FOR BOTH NORMAL AND SUPERELEVATION SECTIONS OF TWO COURSES OF PAVEMENT SHALL BE STRAIGHT.
4. THE ALGEBRAIC DIFFERENCE BETWEEN THE SHOULDER AND TRAVELWAY CROSS SLOPES SHALL NOT EXCEED 8%.
5. THE STATIONING SHOWN UNDER EACH TYPICAL IS APPROXIMATE.

CYCLICAL PAVEMENT RESURFACING

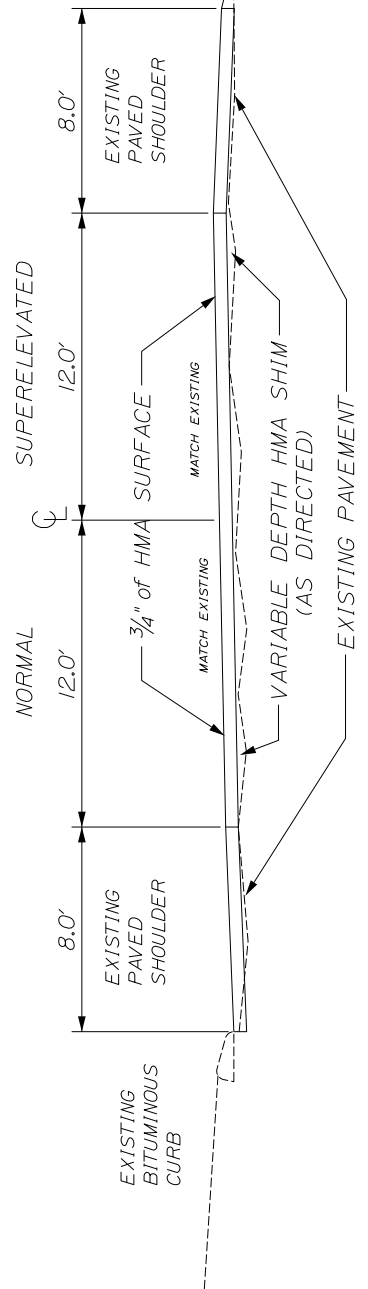

STA 10+00 to 50+00

NOT TO SCALE

CYCLICAL PAVEMENT RESURFACING  
SHOWING EXISTING GUARDRAIL  
AND CURB

NOTE:

1. THE PAVEMENT DEPTHS AS SHOWN ON THE PLANS ARE INTENDED TO BE NOMINAL.
2. WHEN SUPERELEVATION EXCEEDS THE SLOPE OF THE LOW SIDE SHOULDER, THE LOW SIDE SHOULDER SHALL HAVE THE SAME SLOPE AS THE TRAVELWAY.
3. CROWNS FOR BOTH NORMAL AND SUPERELEVATION SECTIONS FOR ALL COURSES OF PAVEMENT SHALL BE STRAIGHT.
4. THE ALGEBRAIC DIFFERENCE BETWEEN THE SHOULDER AND TRAVELWAY CROSS SLOPES FOLLOWED SHALL NOT EXCEED 8%.
5. THE STATIONING SHOWN UNDER EACH TYPICAL IS APPROXIMATE.

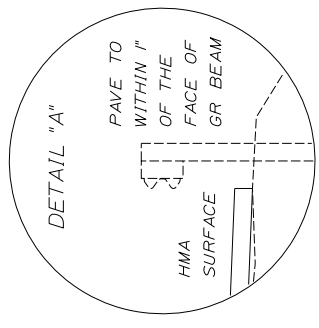
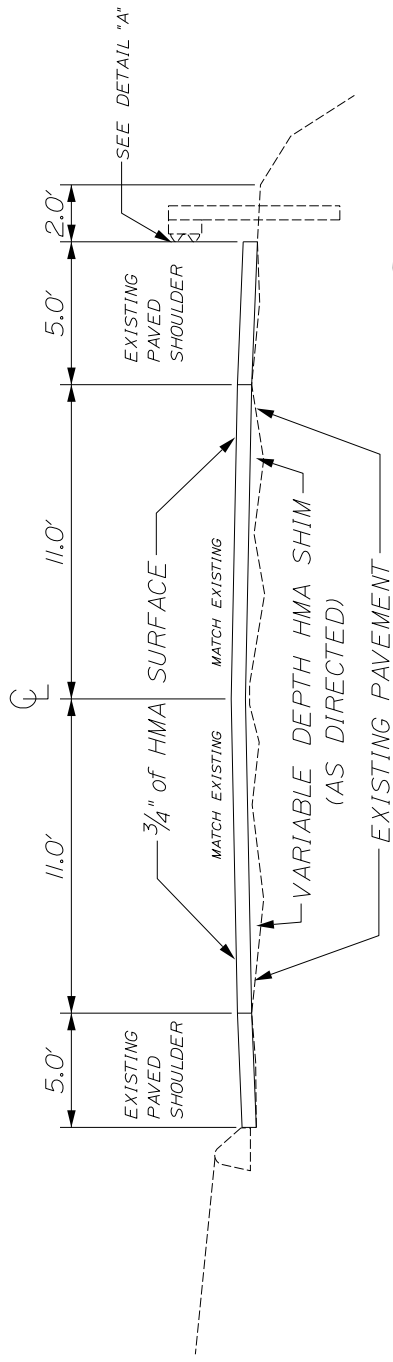

STA 50+00 to 300+40

NOT TO SCALE

PROJECT NUMBER	0000000000
DATE	
DESIGN-DATE	
CHECK-DATE	
DESIGN-REVISIONS	
REVISIONS	
REVISIONS 2	
REVISIONS 1	
FIELD CHANGES	
DATE	
P.E. NUMBER	
SIGNATURE	

- NOTE:
1. THE PAVEMENT DEPTHS AS SHOWN ON THE PLANS ARE INTENDED TO BE NOMINAL.
  2. WHEN SUPERELEVATION EXCEEDS THE SLOPE OF THE LOW SIDE SHOULDER THE LOW SIDE SHOULDER SHALL HAVE THE SAME SLOPE AS THE TRAVELWAY.
  3. CROWNS FOR BOTH NORMAL AND SUPERELEVATION SECTIONS FOR ALL COURSES OF PAVEMENT SHALL BE STRAIGHT.
  4. THE ALGEBRAIC DIFFERENCE BETWEEN THE SHOULDER AND TRAVELWAY CROSS SLOPES ROLL-OVER SHALL NOT EXCEED 8%.
  5. THE STATIONING SHOWN UNDER EACH TYPICAL IS APPROXIMATE.

CYCLICAL PAVEMENT RESURFACING  
SHOWING EXISTING PAVED SHOULDERS  
AND INSLOPE AREAS

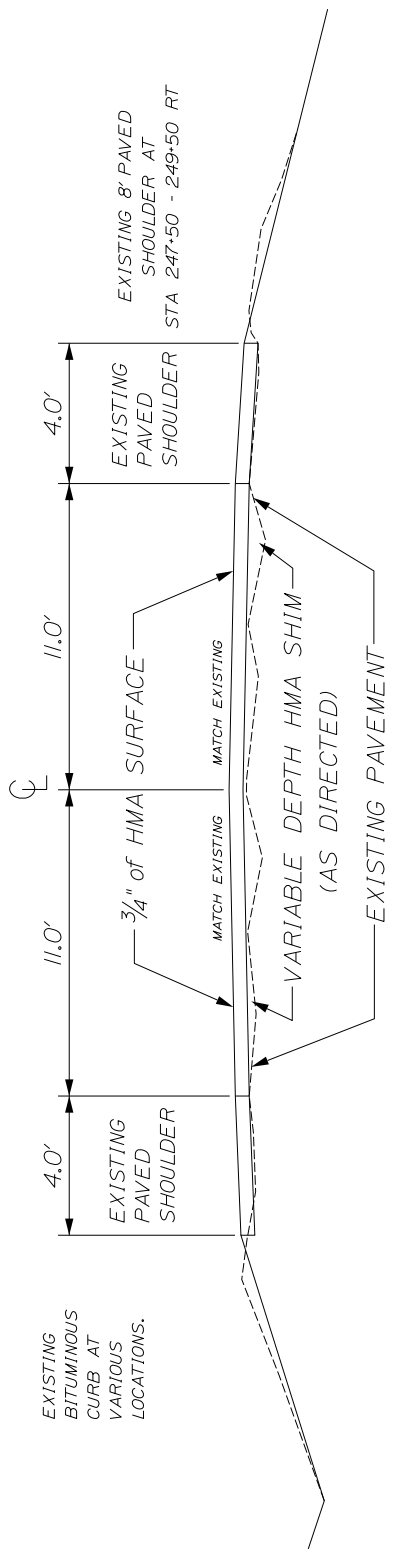

STA 50+00 to 300+40

NOT TO SCALE



**PROJECT STATIONING**

	148+75	35 MPH Speed Limit Sign
CMP Pole #106/85	145+43	
CMP Pole #102/89	139+26	
Jacks Lane	129+48	Forest Lane
CMP Pole #92/99	126+99	
NET&T Pole #86/105	118+16	
Town line Randolph/Chelsea	100+83	Town line Randolph/Chelsea
	81+98	Barber Road
Parkwood Drive	74+25	
Applewood Drive	66+27	
	56+93	Maureen Avenue
Birmingham Road	55+46	
	50+80	Wells Road
	49+04	Kinderhook Street
Ridge Road	32+06	
Fairview Avenue	28+74	
	22+19	Pine Street
Court Street	17+47	
Pleasant Street	14+71	
Maple Street	12+77	South Maple Street
Begin Project	10+00	Begin Project

**PROJECT STATIONING**

End Project	300+40	End Project
	285+78	CMP Pole #5/104
Hallowell Road	269+20	Wellman Road
Chelsea School Sign	248+28	
	238+57	Bridge #3030
	233+95	Brook Lane
Harlan Street	214+30	
	200+38	Hillcrest Drive
NET&T Pole #19/56	192+15	
NET&T Pole #12/63	180+90	
	180+51	45 MPH Speed Limit Sing
Hankerson Road	164+70	Windsor Road
	151+86	Hideaway Acres

**CONSTRUCTION NOTES**

**Item 202.203 – Pavement Butt Joints**

10+00 Start

300+40 End

Use as necessary in side roads, catch basins, and paved drives as directed

**Item 403.211 – Hot Mix Asphalt, 9.5 mm (Shim)**

<b><u>Left</u></b>	<b><u>Right</u></b>
10+30 – 36+00	10+30 – 36+00
45+00 – 51+00	53+00 – 55+00
56+00 – 59+00	61+50 – 64+50
62+50 – 68+00	67+00 – 76+50
70+50 – 76+50	84+00 – 86+00
78+50 – 99+50	88+50 – 90+50
104+00 – 108+00	94+50 – 97+50
114+00 – 123+00	118+00 – 120+75
132+00 --141+00	127+75 – 132+50
143+00 – 150+00	137+00 – 141+00
166+00 – 188+00	144+50 – 148+00
195+00 – 208+00	150+50 – 154+00
210+00 – 227+50	157+50 – 161+00
230+00 – 238+00	166+00 – 184+50
245+00 – 247+00	190+00 – 196+00
250+00 – 258+25	201+00 – 208+00
273+00 – 283+00	230+00 - 238+00
	244+50 – 254+00
	258+25 – 265+50
	267+50 – 268+75
	269+50 – 282+00
	286+00 – 289+50

Shims will be adjusted in the spring by the Department. Shoulder shim will be 4' +/-

**Item 411.10 – Untreated Aggregate Surface Course, Truck Measure**

This item to be used for lips, mailboxes, and other areas as directed by the Department.

**CONSTRUCTION NOTES**

**Item 604.18 – Adjust Manhole or Catch Basin to Grade**

<u>Left</u>	<u>Right</u>
10+47	10+53
13+01	13+81
19+31	16+40
23+36	19+31
42+34	22+69
45+55	237+77
48+26	

Quantities may be adjusted in the spring.

**Item 606.231 – Guardrail Type 3c – 15’ Radius and Less**

105+97.5 Left – 106+10 Left 12.5’

**Item 608.26 – Curb Ramp Detectable Warning Fields**

See Item 608.45

**Item 608.45 – Construct Sidewalk**

12+50 - 12+57 Left Maple Street  
 12+90 – 12+97 Left Maple Street  
 14+44 – 14+51 Left Pleasant Street  
 14+91 – 14+98 Left Pleasant Street  
 17+20 – 17+27 Left Court Street  
 17+57 – 17+64 Left Court Street

**Item 609.31 Curb Type 3.**

12+50 - 12+57 Left Maple Street 7’  
 12+90 – 12+97 Left Maple Street. 7’  
 14+44 – 14+51 Left Pleasant Street 7’  
 14+91 – 14+98 Left Pleasant Street 7’  
 17+20 – 17+27 Left Court Street 7’  
 17+57 – 17+64 Left Court Street 7’  
 23+64 – 23+30 Left 16’  
 47+14 – 47+80 Left 66’  
 Undetermined Locations 198’

## CONSTRUCTION NOTES

### **Item 627.75 – White or Yellow Pavement and Curb Marking Line**

#### Crosswalks

12+77 Left Maple Street

14+71 Left Pleasant Street

17+47 Left Court Street

Painted crosswalk will be Piano Keys.

#### Stop Bars

55+46 Left Birmingham Road 2 x 14'

81+98 Right Barber Road 2' x 12'

300+28 Right Mainline 2' x 42'

### **Item 627.78 – Temporary 4" Pavement Marking Line, White or Yellow**

Temporary center lines and edge lines shall be painted on all matched pavement within one week.

Multilane sections, truck lanes, and milled surfaces must be striped daily on all matched pavement layers.

All temporary lines shall be painted prior to final striping.

Final striping will be done by the Department.

### **Item 629 & 631 – Hand Labor & Equipment Rental**

These items shall be used to grade slopes and ditch as determined by the Department.

### **Item 652.35 – Construction Signs**

Two "Road Work Next 6 Miles" will be required as part of this project.

**GENERAL NOTES**

1. All joints between existing and proposed hot bituminous pavement shall be butted. Payment shall be made under Item 202.203 Pavement Butt Joint.
2. Construct butt joints at all paved drives and entrances. Butt joints shall have a minimum width of 18" or as directed by the Resident.
3. Grind transition tapers at Catch Basins under Item 202.203 Pavement Butt Joints in accordance with Standard Detail 609(05) or as directed by the Resident.
4. Where deemed necessary by the Resident, unsuitable excess material shall be removed from the edges of shoulders and placed in designated areas or disposed of. Payment will be made under the appropriate contract items.
5. The Contractor shall place suitable existing or other material acceptable to the Resident on all pavement edges to allow a drop off no greater than the surface pavement thickness. The material shall be graded to match existing in-slope or as directed by the Resident before surface is placed. The Contractor will be paid under appropriate equipment rental items. Borrow is not authorized until all acceptable waste material has been utilized. Seed and Mulch will be paid for at the contract unit price.
6. Driveway fill side slopes shall be the same as the non-guardrail fill slopes unless otherwise noted on the plans.
7. All waste material not used on the project shall be disposed of off the project in acceptable waste areas reviewed by the Resident. Grading, seeding and mulching of waste areas shall be considered incidental.
8. Required ditch protection shown on the plans or in the Construction Notes is for estimating purposes only. The actual type and location of ditch protection may be altered by the Resident.
9. Any necessary cleaning of existing pavement prior to paving (or milling) shall be incidental to the related paving (or milling) items. This includes killing and removal of all vegetative matter.
10. All existing paved shoulders and widenings to be resurfaced as directed by the Resident.
11. When super elevation exceeds the slope of the low side shoulder, the shoulder pavement will have same slope as traveled way.
12. No existing drainage shall be abandoned, removed or plugged without prior approval of the Resident.

**GENERAL NOTES**

13. Holes created by Guardrail removal will be filled and compacted with approved materials as directed by the Resident. Payment to be considered incidental to the guardrail items.
14. Guardrail which is removed and not reused on the project shall become the property of the Contractor. Removal and disposal shall be considered incidental to the guardrail items.
15. Backing up bituminous or concrete slipform curb is incidental to the curb items. In areas where new bituminous or concrete slipform curb is designated to replace existing, the removal of the old bituminous or concrete slipform curb shall be incidental to the new curb. If called for on the plans or directed by the Resident, loam or dirty borrow will be paid for separately.
16. The Contractor will be responsible for maintaining all existing mailboxes to ensure that the mail will be deliverable. Payment for this work will be made under the appropriate rental items.
17. Any damage to the slopes caused by the Contractor's equipment, personnel, or operation shall be repaired to the satisfaction of the resident. All work, equipment, and materials required to make repairs shall be at the Contractor's expense.
18. No separate payment for superintendent or foreman will be made for the supervision of equipment and layout of work being paid for under the equipment rental items.
19. "Undetermined Locations" shall be determined by the Resident.
20. Stations referenced are approximate.
21. The contractor will place appropriately marked stakes at the following locations on the project: striping pattern changes, cross-slope changes, and every 500' for stationing. The contractor will paint every full station (100') on the existing roadway and will transfer the painted stationing through all intermediate lifts (not surface). Appropriately sized striping pattern changes will be painted on surface. Stationing control must be placed before work can commence. Cross-slope and striping change controls must be placed before paving can commence.
22. Excluding water and gas gate valves, all HMA for patching around adjusted, altered, or rebuilt utility structures shall meet the gradation requirements of a 9.5 mm or 12.5 mm mixture. The Contractor shall saw cut the existing pavement for the patch at least two feet away from the nearest edge of the structure. The Contractor shall place HMA in lifts of 3" or less, as directed by the resident, and compact the HMA using a minimum of a 150-pound plate compactor. HMA for patching around adjusted, altered, or rebuilt utility structures is considered incidental to the respective pay item for adjust, alter, or rebuild utility structure.

**State of Maine  
Department of Labor  
Bureau of Labor Standards  
Augusta, Maine 04333-0045  
Telephone (207) 623-7906**

**Wage Determination - In accordance with 26 MRSA §1301 et. seq., this is a determination by the Bureau of Labor Standards, of the fair minimum wage rate to be paid to laborers and workers employed on the below titled project.**

**Title of Project -----23398.00-Randolph-Chelsea, Rte 226**

**Location of Project --Randolph-Chelsea, Kennebec County**

**2018 Fair Minimum Wage Rates  
Highway & Earth Kennebec County**

<u>Occupation Title</u>	<u>Minimum Wage</u>	<u>Minimum Benefit</u>	<u>Total</u>	<u>Occupation Title</u>	<u>Minimum Wage</u>	<u>Minimum Benefit</u>	<u>Total</u>
Asphalt Raker	\$17.63	\$0.56	\$18.19	Ironworker – Ornamental	\$23.13	\$4.80	\$27.93
Backhoe Loader Operator	\$20.00	\$2.23	\$22.23	Ironworker - Reinforcing	\$24.79	\$10.60	\$35.39
Boom Truck (Truck Crane) Operator	\$21.66	\$6.86	\$28.52	Ironworker - Structural	\$21.80	\$4.88	\$26.68
Bulldozer Operator	\$21.50	\$4.38	\$25.88	Laborer (Includes Helper-Tender)	\$14.50	\$0.95	\$15.45
Carpenter	\$21.00	\$2.36	\$23.36	Laborer - Skilled	\$17.00	\$2.48	\$19.48
Cement Mason/Finisher	\$17.00	\$0.56	\$17.56	Line Erector-Power/Cable Splicer	\$26.00	\$7.59	\$33.59
Crane Operator =>15 Tons)	\$26.00	\$5.97	\$31.97	Loader Operator - Front-End	\$19.00	\$2.88	\$21.88
Crusher Plant Operator	\$18.00	\$3.46	\$21.46	Mechanic- Maintenance	\$20.85	\$3.02	\$23.87
Diver	\$28.50	\$1.48	\$29.98	Painter	\$17.00	\$0.00	\$17.00
Driller -Rock	\$18.38	\$2.60	\$20.98	Paver Operator	\$19.13	\$4.42	\$23.55
Earth Auger Operator	\$22.97	\$6.17	\$29.14	Pipelayer	\$18.00	\$3.16	\$21.16
Electrician - Licensed	\$26.00	\$4.67	\$30.67	Pump Installer	\$21.00	\$3.73	\$24.73
Electrician Helper/Cable Puller (Licensed)	\$17.00	\$2.84	\$19.84	Reclaimer Operator	\$19.13	\$2.98	\$22.11
Elevator Constructor/Installer	\$19.25	\$1.62	\$20.87	Roller Operator - Earth	\$16.00	\$1.89	\$17.89
Excavator Operator	\$21.05	\$2.94	\$23.99	Roller Operator - Pavement	\$18.15	\$2.19	\$20.34
Fence Setter	\$17.25	\$1.72	\$18.97	Screed/Wheelman	\$18.60	\$3.68	\$22.28
Flagger	\$12.00	\$0.00	\$12.00	Truck Driver - Light	\$16.75	\$1.71	\$18.46
Grader/Scraper Operator	\$21.33	\$5.65	\$26.98	Truck Driver - Medium	\$17.75	\$1.99	\$19.74
Highway Worker/Guardrail Installer	\$16.50	\$0.79	\$17.29	Truck Driver - Heavy	\$16.00	\$1.71	\$17.71
Hot Top Plant Operator	\$23.88	\$5.62	\$29.50	Truck Driver - Tractor Trailer	\$18.50	\$2.60	\$21.10

**The Laborer classifications include a wide range of work duties. Therefore, if any specific occupation to be employed on this project is not listed in this determination, call the Bureau of Labor Standards at the above number for further clarification.**

**Welders are classified in the trade to which the welding is incidental.**

**Apprentices - The minimum wage rate for registered apprentices are those set forth in the standards and policies of the Maine State Apprenticeship and Training Council for approved apprenticeship programs.**

**Posting of Schedule - Posting of this schedule is required in accordance with 26 MRSA §1301 et. seq., by any contractor holding a State contract for construction valued at \$50,000 or more and any subcontractors to such a contractor.**

**Appeal - Any person affected by the determination of these rates may appeal to the Commissioner of Labor by filing a written notice with the Commissioner stating the specific grounds of the objection within ten (10) days from the filing of these rates.**

**Determination No: HI-070-2018**

**A true copy**

**Filing Date: February 22, 2018**

**Attest: Scott A. Cotnoir**

**Expiration Date: 12-31-2018**

**Scott A. Cotnoir  
Wage & Hour Director**

**SPECIAL PROVISIONS**  
**SECTION 104**  
**Utilities**

**UTILITY COORDINATION**

The contractor has primary responsibility for coordinating their work with utilities after contract award. The contractor shall communicate directly with the utilities regarding any utility work necessary to maintain the contractor’s schedule and prevent project construction delays. The contractor shall notify the resident of any issues.

**THE CONTRACTOR SHALL PLAN AND CONDUCT WORK ACCORDINGLY.**

**MEETING**

A Preconstruction Utility Conference, as defined in Subsection 104.4.6 of the Standard Specifications {is} required.

**GENERAL INFORMATION**

These Special Provisions outline the arrangements that have been made by the Department for utility and/or railroad work to be undertaken in conjunction with this project. The following list identifies all known utilities or railroads having facilities presently located within the limits of this project or intending to install facilities during project construction.

Utilities have been notified and will be furnished a project specification.

**Overview:**

<b>Utility/Railroad</b>	<b>Aerial</b>	<b>Underground</b>	<b>Railroad</b>
AT&T Co		X	
Central Maine Power Company	X		
Charter Communications	X		
FairPoint Communications - Northern New England Telephone Operations LLC	X	X	
Gardiner Water District		X	
Town of Randolph		X	
Summit Natural Gas of Maine		X	

Town: **Randolph - Chelsea**  
 Project: **023398.00**  
 Date: **January 11, 2018**

<b>Utility Contact Information</b>		
<b>Utility/Railroad</b>	<b>Contact Person</b>	<b>Contact Phone</b>
AT&T Co	Mark Larchar	(207)213-9248
Central Maine Power Company	Tim Robbins	(207)626-9443
Charter Communications	Joshua Mooers	(207)620-3409
FairPoint Communications	Michael Atwater	(207)626-2012
Gardiner Water District	Richard Gray	(207)582-5500
Town of Randolph	Art Forand	(207)582-5808
Summit Natural Gas of Maine	Bryan Haberman	(207)331-6574
Summit Natural Gas of Maine	Garth Vdoviak	(207)621-8000

Temporary utility adjustments are **{not}** anticipated on this project however, should the contractor choose to have any poles temporarily relocated, all work will be done by Pole owner at the contractor's request and expense at no additional cost to the Department.

All adjustments are to be made by the respective utility/railroad unless otherwise specified herein.

Fire hydrants shall not be disturbed until all necessary work has been accomplished to provide proper fire protection.

Utility working days are Monday through Friday.

**AERIAL**

No Aerial Utility adjustments are anticipated at this time for the project. Though unexpected, if utility relocations become necessary, they will be scheduled in compliance with Section 104 of the Standard Specifications and will be done by the utilities after the Contractor has finished their work.

***Utility Specific Issues:***

All utilities require **5 working days advance notice** prior to any operations involving work around their lines.

Utility adjustments are anticipated as part of this project.

**\*\* POLE LIST \*\***

Existing Pole CMP 0 ½ FP 99/41 transfer lines from older pole to newer pole & remove old pole  
 Existing Pole FP 91/43/FP 99/FP 44 transfer lines from older pole to newer pole & remove old pole  
 Existing Pole CMP 46/FP 48 transfer lines from older pole to newer pole & remove old pole  
 Existing Pole CMP 49/FP 51 transfer lines from older pole to newer pole & remove old pole  
 Existing Pole CMP 50/FP 52 transfer lines from older pole to newer pole & remove old pole  
 Existing Pole CMP 50S/FP 52S transfer lines from older pole to newer pole & remove old pole  
 Existing Pole CMP 50 transfer lines from older pole to newer pole & remove old pole  
 Existing Pole CMP 50S transfer lines from older pole to newer pole & remove old pole  
 Existing Pole FP 56 transfer lines from older pole to newer pole & remove old pole  
 Existing Pole FP 55 transfer lines from older pole to newer pole & remove old pole  
 Existing Pole FP 58/CMP 55 ½ transfer lines from older pole to newer pole & remove old pole  
 Existing Pole FP 79/112 transfer lines from older pole to newer pole & remove old pole  
 Existing Pole FP 99/80/111 transfer lines from older pole to newer pole & remove old pole  
 Existing Pole FP 81/110 transfer lines from older pole to newer pole & remove old pole

The Aerial utilities will work together on fixing several issues where the guy wires are coming down towards the roadway, transfers and replacing poles with safety issues. The appropriate utility will remove old poles when all transfers have been done.

The Aerial utilities require **5 working days advance notice** prior to any operations involving work around their lines.

**SUBSURFACE**

Utility	Summary of Work	Estimate of Working Days
Gardiner Water District	Raising valve boxes	6
		Total: 6

***Utility Specific Issues:***

**AT & T** has buried cable along the project. AT & T requires **5 working days advance notice** prior to any operations involving the relocation of their lines.

**FairPoint** has buried cable along the project. Fairpoint requires **5 working days advance notice** prior to any operations involving the relocation of their lines.

Town: **Randolph - Chelsea**  
Project: **023398.00**  
Date: **January 11, 2018**

**Gardiner Water District (GWD)** has a drinking water system located within the limits of the project. As a result of this project GWD will be rebuilding/adjusting **14** Water Gates Valves to grade as a result of this project. GWD **requires 10 working days advance notice** prior to have a person onsite while the contractor is digging near their facilities or to make any adjustments to them.

**Summit Natural Gas of Maine** has a pipe line within the project limits. Coordinate with Summit Natural Gas of Maine in advance of excavation within the proximity of the main so they can provide on-site representative. Summit Natural Gas of Maine **requires 5 working days advance notice** prior to any operations involving work around their buried lines.

**Town of Randolph** has a sewer system located within the limits of the project. Town of Randolph has entered into an agreement with MaineDOT to include this relocation as part of the Project. As a result of this project MaineDOT's contractor will be adjusting **10** Sewer manholes, modifying/altering **18** manholes and rebuilding **9** manholes to grade within the project. Town of Randolph **requires 5 working days advance notice** prior to have a person onsite while the contractor is digging near their facilities or to make any adjustments to them.

#### **MAINTAINING UTILITY LOCATION MARKINGS**

The Contractor will be responsible for maintaining the buried utility location markings following the initial locating by the appropriate utility or their designated representative.

#### **UTILITY SIGNING**

Any utility working within the construction limits of this project shall ensure that the traveling public is adequately protected at all times. All work areas shall be signed, lighted, and traffic flaggers employed as determined by field conditions. All traffic controls shall be in accordance with the latest edition of the Manual on Uniform Traffic Control Devices for Streets and Highways, as issued by the Federal Highway Administration.

Project WIN: 23398.00

**SPECIAL PROVISION 105**  
**CONSTRUCTION AREA**

A Construction Area located in the **Towns of Randolph and Chelsea** has been established by the Maine Department of Transportation (MDOT) in accordance with provisions of 29-A § 2382 Maine Revised Statutes Annotated (MRSA).

- (a) The section of highway under construction in Kennebec County on Route 226, WIN 23398.00 begins in Randolph at Water Street (Route 27) and extends northeasterly 5.50 miles to Eastern Avenue (Route 17) in Chelsea.

Per 29-A § 2382 (7) MRSA, the MDOT may “*issue permits for stated periods of time for loads and equipment employed on public way construction projects, United States Government projects or construction of private ways, when within construction areas established by the Department of Transportation. The permit:*

*A. Must be procured from the municipal officers for a construction area within that municipality;*

*B. May require the contractor to be responsible for damage to ways used in the construction areas and may provide for:*

*(1) Withholding by the agency contracting the work of final payment under contract; or*

*(2) The furnishing of a bond by the contractor to guarantee suitable repair or payment of damages.*

*The suitability of repairs or the amount of damage is to be determined by the Department of Transportation on state-maintained ways and bridges, otherwise by the municipal officers;*

*C. May be granted by the Department of Transportation or by the state engineer in charge of the construction contract; and*

*D. For construction areas, carries no fee and does not come within the scope of this section.”*

The Municipal Officers for the **Towns of Randolph and Chelsea** agreed that an Overlimit Permit will be issued to the Contractor for the purpose of using loads and equipment on municipal ways in excess of the limits as specified in 29-A MRSA, on the municipal ways as described in the “Construction Area”.

As noted above, a bond may be required by the municipality, the exact amount of said bond to be determined prior to use of any municipal way. The MDOT will assist in determining the bond amount if requested by the municipality.

The maximum speed limits for trucks on any town way will be 25 mph (40 m per hour) unless a higher legal limit is specifically agreed upon in writing by the Municipal Officers concerned.

**SPECIAL PROVISION**  
**SECTION 105**  
General Scope of Work  
(Limitations of Operations)

1. The Contractor shall be limited to one paving operation per day (excluding hand work) unless authorized by the Resident.
2. Absences must be requested at least 72 hours in advance, and are subject to Department approval based on existing roadway condition, paving deadlines, adherence to schedule, traffic restrictions, detours, etc. The Contractor must assure that the roadway surface and signage are maintained for safe passage of the traveling public during any approved absences. The Contract Completion Date will not be modified due to approved absences.
3. The Contractor shall plan operations so that the Resident will have sufficient advance notification to provide the necessary inspection and testing. Sufficient notification will be considered 48 hours.
4. The Contractor shall provide a 48-hour notice prior to working any Saturday.
5. At a minimum the contractor will maintain one 11' wide lane of alternating traffic.
6. No lane closures will be allowed between Route 27 and Birmingham Road from 7:00 am to 8:00 am and from 3:00 pm to 6:00 pm
7. The contractor may elect to work at night provided that they obtain written permission from the municipalities impacted.

SPECIAL PROVISION  
SECTION 107  
PROSECUTION AND PROGRESS  
(Contract Time)

This Contract shall be completed within **44** continuous calendar days. The Contractor may begin work anytime in accordance with Standard Specification 104.4.2 and upon approval of all required submittals. The Contract Completion Date will be no later than **September 22, 2018**

At least 21 calendar days prior to the desired Begin Construction Date, the Contractor shall submit an **electronic copy of their signed request to begin work and the Begin Construction Date.** This signed request shall be sent read receipt through **email** with their **Schedule of Work**, in accordance with Standard Specification 107.4.2, to **[Shawn.Smith@Maine.gov](mailto:Shawn.Smith@Maine.gov)**, **[Emory.Lovely@Maine.gov](mailto:Emory.Lovely@Maine.gov)**, **[Thomas.Stevens@Maine.gov](mailto:Thomas.Stevens@Maine.gov)** and **[Scott.Bickford@Maine.gov](mailto:Scott.Bickford@Maine.gov)**. The Contractor shall notify all utility contacts listed in the 104 Special Provision and provide the utility contacts the submitted schedule of work within 2 calendar days of the schedule of work submittal. **A penalty in the amount of \$500/day will be assessed for each calendar day or partial calendar day beyond June 15<sup>th</sup> that the schedule of work is not received.** Upon receipt of the schedule of work, a pre-construction meeting will be scheduled. A Contract Modification will be executed to document the new Contract Completion Date based upon the Begin Construction Date. The modified Contract Completion Date shall not exceed the Contract Completion Date specified in this special provision.

The Contractor may request to adjust the submitted schedule of work and Begin Construction Date once after the initial submittal. The Department will allow adjustments in the Begin Construction Date of up to seven calendar days if the request is made at least 21 calendar days prior to the updated Begin Construction Date. This signed request shall be sent read receipt through **email** with their **Schedule of Work**, in accordance with Standard Specification 107.4.2, to **[Shawn.Smith@Maine.gov](mailto:Shawn.Smith@Maine.gov)**, **[Emory.Lovely@Maine.gov](mailto:Emory.Lovely@Maine.gov)**, **[Thomas.Stevens@Maine.gov](mailto:Thomas.Stevens@Maine.gov)** and **[Scott.Bickford@Maine.gov](mailto:Scott.Bickford@Maine.gov)**. The Contractor shall notify all utility contacts listed in the 104 Special Provision and provide the utility contacts the updated schedule of work within 2 calendar days of the request to adjust the Begin Construction Date.

Once operations commence, for every weekday not worked the Contractor will be charged supplemental liquidated damages per Section 107.7.2 of the Standard Specifications; excluding days lost to inclement weather, holidays, and approved absences.

Work will not be allowed from Friday, May 25, 2018 at 12:00pm (Noon) until Tuesday, May 29, 2018 at 6:00am due to Memorial Day. Work will not be allowed from Tuesday, July 3, 2018 at 12:00pm (Noon) until Thursday, July 5, 2018 at 6:00 am due to the 4<sup>th</sup> of July. Work will not be allowed from Friday, August 31, 2018 at 12:00pm (Noon) until Tuesday, September 4, 2018 at 6:00am due to Labor Day.

**SPECIAL PROVISION**  
**SECTION 107**  
**SCHEDULING OF WORK**

Replace Section 107.4.2 with the following:

”107.4.2 Schedule of Work Required Within 21 Days of Contract Execution and before beginning any on-site activities, the Contractor shall provide the Department with its Schedule of Work. The Contractor shall plan the Work, including the activity of Subcontractors, vendors, and suppliers, such that all Work will be performed in Substantial Conformity with its Schedule of Work. The Schedule must include sufficient time for the Department to perform its functions as indicated in this Contract, including QA inspection and testing, approval of the Contractor's TCP, SEWPCP and QCP, and review of Working Drawings.

At a minimum, the Schedule of Work shall include a bar chart which shows the major Work activities, milestones, durations, **submittals and approvals**, and a timeline. Milestones to be included in the schedule include: (A) start of Work, (B) beginning and ending of planned Work suspensions, (C) Completion of Physical Work, and (D) Completion. If the Contractor Plans to Complete the Work before the specified Completion date, the Schedule shall so indicate.

Any restrictions that affect the Schedule of Work such as paving restrictions or In-Stream Work windows must be charted with the related activities to demonstrate that the Schedule of Work complies with the Contract.

The Department will review the Schedule of Work and provide comments to the Contractor within 20 days of receipt of the schedule. The Contractor will make the requested changes to the schedule and issue the finalized version to the Department.”

**SPECIAL PROVISION**  
**SECTION 401 - HOT MIX ASPHALT PAVEMENT**

The Standard Specification 401 – Hot Mix Asphalt Pavement, has been modified with the following revisions. All sections not revised by this Supplemental Specification shall be as outlined in Section 401 of the Standard Specifications.

401.07 Hot Mix Asphalt Plant

401.071 General Requirements HMA plants shall conform to AASHTO M156-97.

a. Truck Scales When the hot mix asphalt is to be weighed on scales meeting the requirements of Section 108 - Payment, the scales shall be inspected and sealed by the State Sealer as often as the Department deems necessary to verify their accuracy.

Plant scales shall be checked prior to the start of the paving season, and each time a plant is moved to a new location. Subsequent checks will be made as determined by the Resident. The Contractor will have at least ten 50 pound masses for scale testing.

b. Additives Additives (WMA, anti-strip, etc.) not directly introduced into the binder at the terminal shall be introduced into the HMA plant per the supplier's recommendations and shall be approved by the Asphalt Pavement Engineer, Pavement Quality Manager, or their authorized representative. The system for introducing additives shall be interlocked with the aggregate feed or weigh system to maintain correct proportions for all rates of production and batch sizes. Additive introduction systems shall be controlled by a proportioning device to the amount required on the JMF plus or minus 0.1% of the target. Additive introduction systems shall be interlocked with the plant and the recordation (batch tickets or drum recordation) shall display the additive and the weight and percentage added.

c. Stockpiles HMA plants shall have sufficient space for stockpiles, with a minimum of supply for 2 days production of all aggregate products used in MaineDOT approved mix designs currently under production for the facility at all times. A minimum stockpile supply of 100 ton (70 yards) shall be maintained at all times no matter the production rate for the HMA plant. Stockpiles shall be separated and built to minimize segregation.

401.18 Quality Control Method A, B & C The Contractor shall operate in accordance with the approved Quality Control Plan (QCP) to assure a product meeting the contract requirements. The QCP shall meet the requirements of Section 106.6 - Acceptance and this Section. The Contractor shall not begin paving operations until the Department approves the QCP in writing.

The QCP shall address any items that affect the quality of the Hot Mix Asphalt Pavement including, but not limited to, the following:

- a. JMF(s)
- b. Hot mix asphalt plant details
- c. Stockpile Management (to include provisions for how the requirements of 401.071c will be met)
- d. Make and type of paver(s)
- e. Make and type of rollers including weight, weight per inch of steel wheels, and average contact pressure for pneumatic tired rollers
- f. Name of QCP Administrator, and certification number
- g. Name of Process Control Technician(s) and certification number(s)
- h. Name of Quality Control Technicians(s) and certification number(s)
- i. Mixing & transportation including process for ensuring that truck bodies are clean and free of debris or contamination that could adversely affect the finished pavement
- j. Testing Plan
- k. Laydown operations including longitudinal joint construction, procedures for avoiding paving in inclement weather, type of release agent to be used on trucks tools and rollers, compaction of shoulders, tacking of all joints, methods to ensure that segregation is minimized, procedures to determine the maximum rolling and paving speeds based on best engineering practices as well as past experience in achieving the best possible smoothness of the pavement. Solvent based agents developed to strip asphalts from aggregates will not be allowed as release agents.
- l. Examples of Quality Control forms including a daily plant report, daily paving report, and delivery slip template for any plant to be utilized.
- m. Silo management and details (can show storage for use on project of up to 36 hours)
- n. Provisions for varying mix temperature due to extraordinary conditions or production limitations. If a warm-mix technology is utilized, a proposed target production temperature range (not to exceed 50°F) will be provided for each mix design.
- o. Name and responsibilities of the Responsible onsite Paving Supervisor.
- p. Method for calibration/verification of Density Gauge
- q. A note that all testing will be done in accordance with AASHTO and the MaineDOT Policies and Procedures for HMA Sampling and Testing.
- r. A detailed description of RAP processing, stockpiling and introduction into the plant as well as a note detailing conditions under which the percent of RAP will vary from that specified on the JMF.
- s. A detailed procedure outlining when production will be halted due to QC or Acceptance testing results.
- t. A plan to address the change in PGAB source or supplier and the potential co-mingling of differing PGAB's.
- u. A procedure to take immediate possession of acceptance samples once released by MaineDOT and deliver said samples to the designated acceptance laboratory.
- v. Provisions for how the QCP will be communicated to the Contractor's field personnel

The Contractor shall cease paving operations whenever one of the following occurs on a lot in progress:

- a. Method A: The Pay Factor for VMA, Voids @  $N_d$ , Percent PGAB, composite gradation, VFB, fines to effective binder or density using all Acceptance or all Quality Control tests for the current lot is less than 0.85. No ceasing of paving operations shall be required for fines to effective binder if the mean test value is equal to the LSL or USL and  $s = 0$ .
- b. Method B: The Pay Factor for VMA, Voids @  $N_d$ , Percent PGAB, composite gradation, VFB, fines to effective binder or density using all Acceptance or all Quality Control tests for the current lot is less than 0.90. No ceasing of paving operations shall be required for fines to effective binder if the mean test value is equal to the LSL or USL and  $s = 0$ .
- c. Method C: The Pay Factor for Percent PGAB, percent passing the nominal maximum sieve, percent passing 2.36 mm sieve, percent passing 0.300 mm sieve, percent passing 0.075 mm sieve or density using all Acceptance or all available Quality Control tests for the current lot is less than 0.85. No ceasing of paving operations shall be required for percent passing the nominal maximum sieve, percent passing 2.36 mm sieve, percent passing 0.300 mm sieve, or percent passing 0.075 mm sieve if the mean test value is equal to the LSL or USL and  $s = 0$ .
- d. The Coarse Aggregate Angularity or Fine Aggregate Angularity value falls below the requirements of Table 3: Aggregate Consensus Properties Criteria in Section 703.07 for the design traffic level.
- e. Each of the first 2 control tests for a Method A or B lot fall outside the upper or lower limits for VMA, Voids @  $N_d$ , or Percent PGAB; or under Method C, each of the first 2 control tests for the lot fall outside the upper or lower limits for the nominal maximum, 2.36 mm, 0.300 mm or 0.075 mm sieves, or percent PGAB.
- f. The Flat and Elongated Particles value exceeds 10% by ASTM D4791.
- g. There is any visible damage to the aggregate due to over-densification other than on variable depth shim courses.
- h. The Contractor fails to follow the approved QCP.

401.203 Method C Lot Size will be the entire production per JMF for the project, or if so agreed at the Pre-paving Conference, equal lots of up to 4500 tons, with unanticipated over-runs of up to 1500 ton rolled into the last lot. Sublot sizes shall be 750 ton for mixture properties, 500 ton for base or binder densities and 250 ton for surface densities. The minimum number of sublots for mixture properties shall be 4, and the minimum number of sublots for density shall be five.

TABLE 7: METHOD C ACCEPTANCE LIMITS

Property	USL and LSL
Passing 4.75 mm and larger sieves	Target +/-7%
Passing 2.36 mm to 1.18 mm sieves	Target +/-5%
Passing 0.60 mm	Target +/-4%
Passing 0.30 mm to 0.075 mm sieve	Target +/-2%
PGAB Content	Target +/-0.4%
% TMD (In place density)	95.0% +/- 2.5%

#### Pay Adjustment Method C

The Department will use density, Performance Graded Asphalt Binder content, and the percent passing the nominal maximum, 2.36 mm, 0.300 mm and 0.075 mm sieves for the type of HMA represented in the JMF. If the PGAB content falls below 0.80, then the PGAB pay factor shall be 0.55.

Density: For mixes having a density requirement, the Department will determine a pay factor using Table 7: Method C Acceptance Limits:

$$PA = (\text{density PF} - 1.0)(Q)(P) \times 0.50$$

PGAB Content and Gradation The Department will determine a pay factor using Table 7: Method C Acceptance Limits. The Department will calculate the price adjustment for Mixture Properties as follows:

$$PA = (\% \text{ Passing Nom. Max PF} - 1.0)(Q)(P) \times 0.05 + (\% \text{ passing 2.36 mm PF} - 1.0)(Q)(P) \times 0.05 + (\% \text{ passing 0.30 mm PF} - 1.0)(Q)(P) \times 0.05 + (\% \text{ passing 0.075 mm PF} - 1.0)(Q)(P) \times 0.10 + (\text{PGAB PF} - 1.0)(Q)(P) \times 0.25$$

401.223 Process for Dispute Resolution (Methods A B & C only)

TABLE 10: DISPUTE RESOLUTION VARIANCE LIMITS

PGAB Content	+/-0.4%
G <sub>mb</sub>	+/-0.030
G <sub>mm</sub>	+/-0.020
Voids @ N <sub>d</sub>	+/-0.8%
VMA	+/-0.8%
Passing 4.75 mm and larger sieves	+/- 4.0%
Passing 2.36 mm to 0.60 mm sieves	+/- 3.0%
Passing 0.30 mm to 0.15	+/- 2.0 %
0.075 mm sieve	+/- 0.8%

**SPECIAL PROVISION**  
**SECTION 403**  
**HOT MIX ASPHALT**

Desc. Of Course	Grad Design.	Item Number	Total Thick	No. Of Layers	Comp. Notes
<b><u>¾" HMA Overlay with Shim</u></b>					
<b><u>Travelway &amp; Shoulders (As Indicated)</u></b>					
Wearing	9.5 mm	461.210	¾"	1	1,2,4,9,11,14,20,27
Shim	9.5 mm	403.211	variable	1/more	1,2,4,9,11,14,20
<b><u>Drives, Misc.</u></b>					
Wearing	9.5 mm	403.209	1"	1/more	1,2,3,10,11,14

**COMPLEMENTARY NOTES**

1. The required PGAB for this mixture will meet a **PG 64-28** grading. All asphalt grades utilized on the Project shall be treated with an approved liquid anti-strip. PG binders shall be treated with a minimum 0.50 percent anti-strip by weight of asphalt binder used unless otherwise recommended by the anti-strip manufacturer. The PGAB and anti-strip blend shall meet the **PG 64-28** requirements. The Contractor shall provide supporting test data showing the PGAB and anti-strip blend meet the required criteria.
2. The incentive/disincentive provisions for density shall not apply. Rollers shall meet the requirements of this special provision. The use of an oscillating steel roller shall be required to compact all mixtures pavements placed on bridge decks.
3. The design traffic level for mix placed shall be <0.3 million ESALS. The design, verification, Quality Control, and Acceptance tests for this mix will be performed at **50 gyrations**.
4. The design traffic level for mix placed shall be 0.3 to <3 million ESALS. The design, verification, Quality Control, and Acceptance tests for this mix will be performed at **50 gyrations**.
9. Section 106.6 Acceptance, (2) Method C. The Contractor may request a contract modification to change to testing method "A" prior to work starting on this item.
10. Section 106.6 Acceptance, (2) Method D.
11. The combined aggregate gradation required for this item shall be classified as a 9.5mm "**fine graded**" mixture, (using the Primary Control Sieve control point) as defined in 703.09.
14. The combined aggregate gradation required for this item shall be classified as a 9.5mm Thin Lift Mixture (TLM) mixture, using the Aggregate Gradation Control Points as defined in 703.09.

20. The Contractor may place the specified HMA pavement course, not to exceed 1 inch compacted depth, over the full single travel lane width, for each production day. If this option is utilized the Contractor will be required to place a matching course of HMA over the adjacent section of travel lane before weekend suspension. The Contractor will also be responsible for installing additional warning signage that clearly defines the centerline elevation differential hazard. Unless otherwise addressed in the contract, the Contractor shall install additional centerline delineation such as a double RPM application, or temporary painted line for centerline at the end of each production day. The Traffic Control Plan shall be amended to include this option and the additional requirements. All signs and traffic control devices will conform to Section 719.01, and Section 652, and will be installed prior to the work, at a maximum spacing of 0.50 mile for the entire length of effected roadway section. On roadways with two-way traffic, the Contractor will be required to place the specified course over the full width of the mainline traveled way being paved prior to opening the sections to weekend or holiday traffic. If this option is utilized, all additional signing, labor, traffic control devices, or incidentals will not be paid for directly, will be considered incidental to the appropriate 652 items.
27. See Special Provision 461 – Cyclical Pavement Resurfacing

#### Tack Coat

A tack coat of emulsified asphalt, RS-1, RS-1h, CRS-1 or CRS-1h, Item 409.15 shall be applied to any existing pavement at a rate of approximately 0.030 gal/yd<sup>2</sup>, and on milled pavement approximately 0.05 gal/yd<sup>2</sup> prior to placing a new course. A fog coat of emulsified asphalt shall be applied between shim /base courses and surface course as well as to any bridge membrane prior to the placement of HMA layers at a rate not to exceed 0.030 gal/yd<sup>2</sup>. Tack used will be paid for at the contract unit price for Item 409.15 Bituminous Tack Coat.

SPECIAL PROVISION SECTION 461  
**HOT MIX ASPHALT**  
(Cyclical Pavement Resurfacing)

Description The Contractor shall furnish a uniformly blended, homogeneous mixture placed as one or more courses of Hot Mix Asphalt Pavement (HMA) on an approved base in accordance with the contract documents and in reasonably close conformity with the lines, grades, thickness, and typical cross sections shown on the plans or established by the Resident. The Department shall accept this work under Quality Assurance provisions as specified in Standard Specification Section 400; Subsection 401 - Hot Mix Asphalt Pavement, and Standard Specifications Section 106 - Quality.

The following shall be added to the Standard Specification Section 108.4.1 Price Adjustment for Hot Mix Asphalt:

Item 461.210 Hot Mix Asphalt - 9.5 mm (Cyclical Pavement Resurfacing)

Item 461.210-6.2%

The Cyclical Pavement Resurfacing shall meet all of the Materials, Seasonal Limitations, Equipment, and Construction requirements of Section 401, with the following additions and changes.

Weather and Seasonal Limitations All work shall be in accordance with Division 400 – Pavements; Section 401 – Hot Mix Asphalt Pavement , subsection 401.06- Weather and Seasonal Limitations, with the exception of the following revisions;

The minimum pavement surface temperature for application of the tack coat and placement of the wearing course is 50° F. Paver Placed Surface shall be completed by the Saturday after September 15<sup>th</sup>. If an accepted WMA technology is utilized, the Cyclical Pavement Resurfacing shall be completed by the Saturday after October 1<sup>st</sup>.

Materials The combined aggregate gradation required for this item shall be classified as a 9.5mm Thin Lift Mixture (TLM) mixture, using the Aggregate Gradation Control Points as defined in 703.09.

Compaction As a minimum, compaction of the Cyclical Pavement Resurfacing will be obtained using a minimal roller train consisting of a 10 ton vibratory roller, 16 ton pneumatic roller, and a 10 ton finish roller. As a minimum, the pavement will rolled by a dual drum vibratory roller operating in high frequency / low amplitude mode, a pneumatic roller will be used over the entire paved surface, and shall be finished with a dual drum roller operation in static mode. Once the methods are established, rolling patterns, equipment, and methods will become part of the QCP. Failure to conform to these requirements will be treated as a second incident under 106.4.6 QCP Non-compliance.

Acceptance Method A, B & C – Control Strip Requirements Mixtures shall be evaluated under Method C criteria unless otherwise specified in the 403 special provision. Test strips will not be required. If using a new mix design, the Contractor may make any final adjustments to the job mix formula in accordance to Standard Specifications, Section 401, subsection 401.03 – Composition of Mixtures.

The Contractor will be required to provide a QCT onsite for the placement of the Cyclical Pavement Resurfacing mixes. A control section will be established at the beginning of the first day of surface placement. The QCT will monitor placement activities and maximize the density of the material for each day of placement. The QCT will be required to perform density testing of the mixture using a density meter (according to ASTM D 2950). The QCT will monitor pavement density to establish roller patterns. The control section mixture will be rolled by each roller until the density readings show less than 1 pcf change for the final roller passes. This density will be used as the target TMD for the mixture. The remainder of the areas to be paved shall be compacted to a minimum density of 98% of the target density as determined in the control section.

The Contractor shall record and provide reports of each day's results, including a daily paving report listing the mixture type, mixture temperatures, equipment used, environmental conditions, and number of roller passes used to obtain the target TMD. Reports shall be signed by the QCT and presented to the Department's representative by the end of the working day. The QCT shall be required to be onsite during all mainline paving operations.

The Department may halt the production and placement of the Cyclical Pavement Resurfacing and require the construction of a new control strip if the Department finds that material being produced, hauled, or placed does not meet the requirements of Sections 401.08 through 401.18.

Method of Measurement The Department will measure Cyclical Pavement Resurfacing pavement by the ton in accordance with Section 109 - Measurement and Payment.

Basis of Payment The Department will pay for the Work, in place and accepted, in accordance with the applicable sections of this Special Provision; at the contract unit price per ton for the Pay Item listed in Special Provision Section 403 – Hot Mix Asphalt.

Payment will be made under:

<u>Pay Item</u>	<u>Pay Unit</u>
461.210 9.5mm HMA – Cyclical Pavement Resurfacing	Ton

SPECIAL PROVISION  
SECTION 652  
MAINTENANCE OF TRAFFIC

Approaches. Approach signing shall include the following signs at a minimum. Field conditions may warrant the use of additional signs as determined by the Resident..

Road Work Next X\* Miles  
Road Work 500 Feet (Ahead)  
End Road Work

Work Areas. At each work site, signs and channelizing devices shall be used as directed by the Resident.

Signs include:

Road Work xxxx<sup>1</sup>.  
One Lane Road Ahead  
Flagger Sign

Other typical signs include:

Be Prepared to Stop  
Low Shoulder  
Bump  
Pavement Ends

The above lists of Approach signs and Work Area signs are representative of the contract requirements. Other sign legends may be required.

The Contractor shall conduct their operations in such a manner that the roadway will not be restricted to one lane for more than 2,500 feet at each work area. To encourage quality paving in warm-weather conditions, the length can be extended to 4,000 feet depending on the traffic impacts. Where more than one work area restricts traffic to one lane operation, these work areas shall be separated by at least 1 mile of two way operation.

**Temporary Centerline** A temporary centerline shall be placed each day on all new pavement to be used by traffic. The temporary centerline, when specified of reflectorized traffic paint, shall conform to the standard marking patterns used for permanent markings. Failure to apply a temporary centerline daily will result in a Traffic Control Violation and suspension of paving operations until temporary markers are applied to all previously placed pavement.

<sup>1</sup> “Road Work Ahead” to be used in short duration operations and “Road Work xx feet” to be used in stationary operations as directed by the Resident.

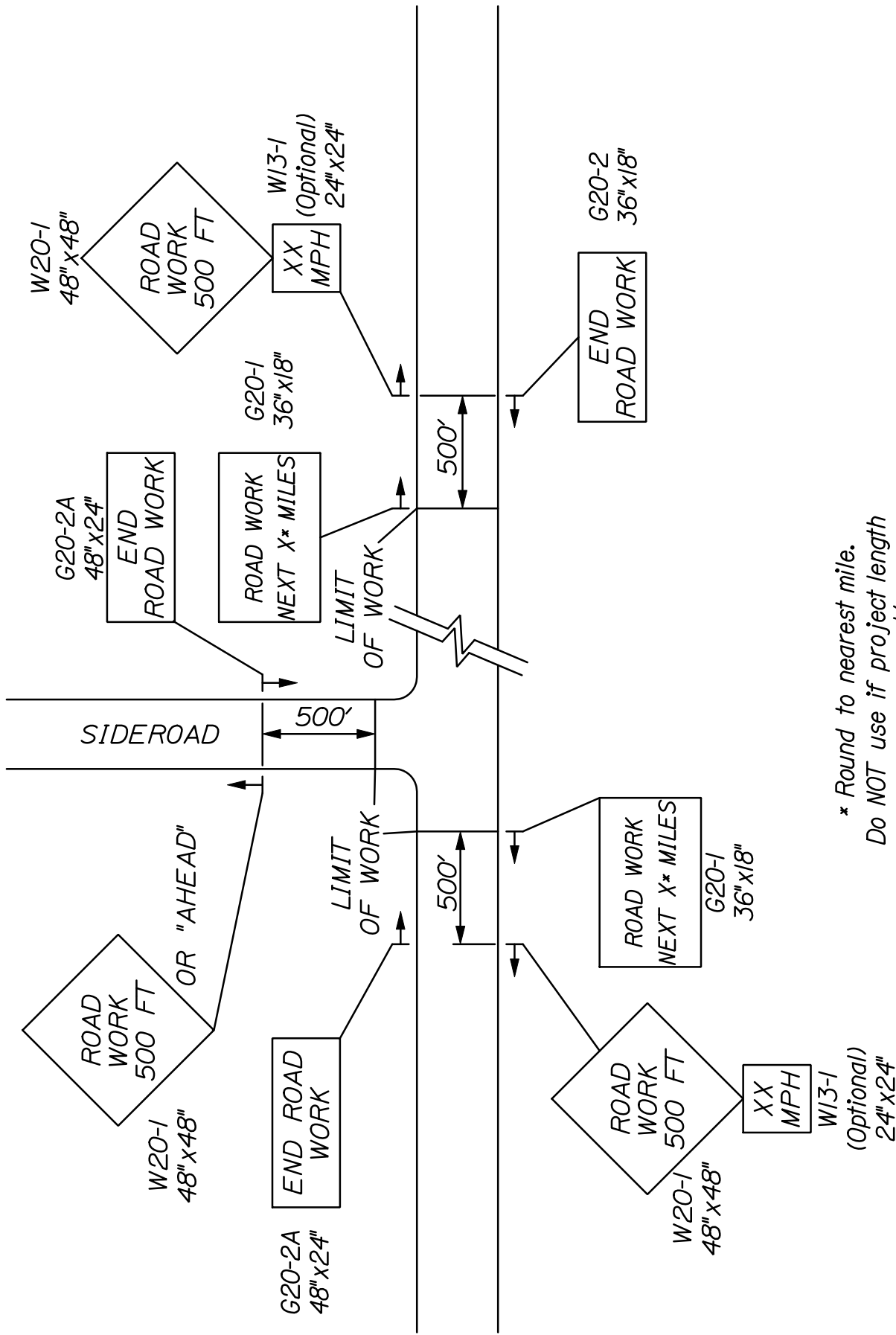

\* Round to nearest mile.  
 Do NOT use if project length  
 is less than a 1/2 mile.

~ PROJECT APPROACH SIGNING ~  
 TWO WAY TRAFFIC

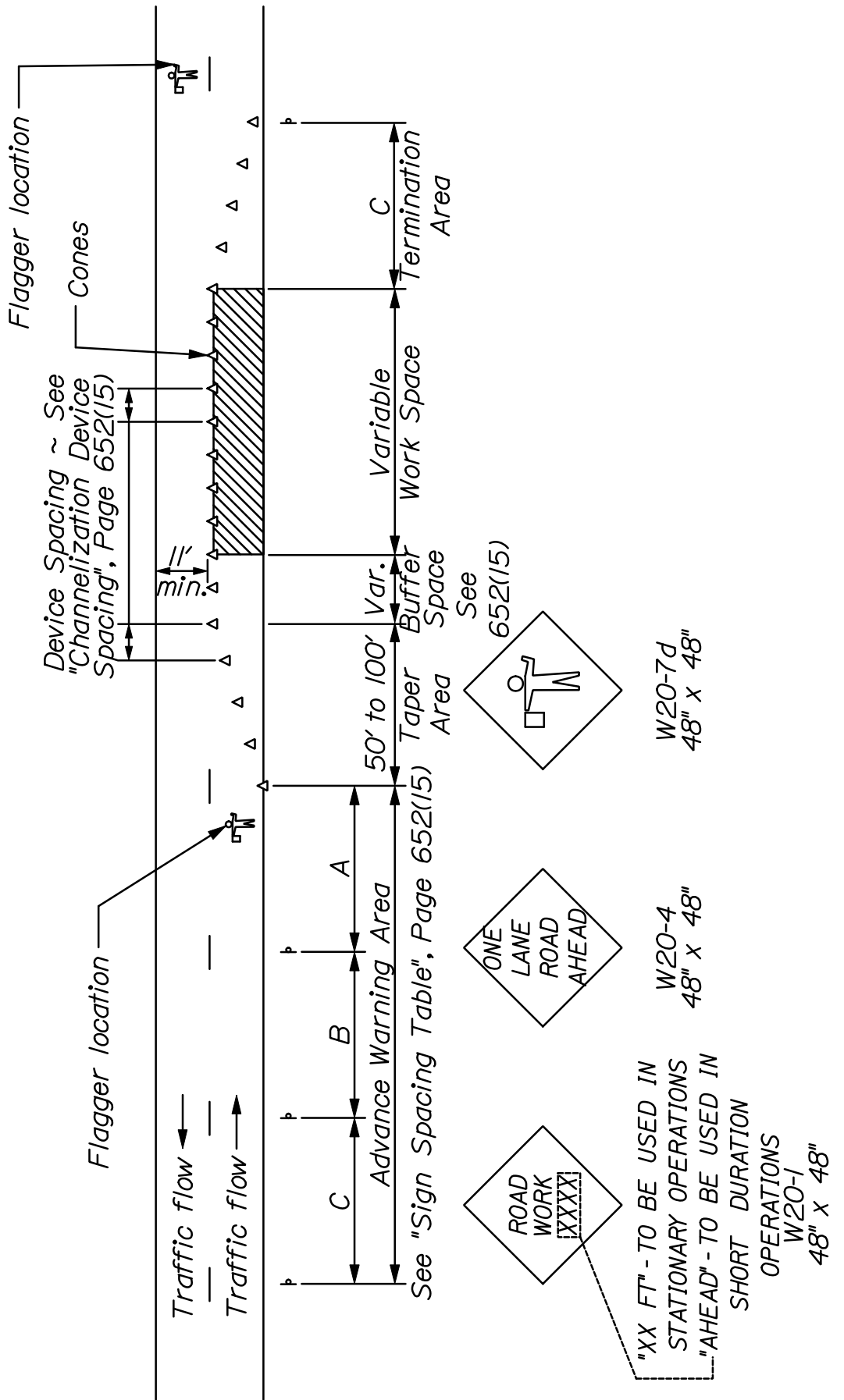

~ TYPICAL APPLICATION: TWO -WAY, TWO LANE ROADWAY,  
 CLOSING ONE LANE USING FLAGGERS ~

\* Formulas for L are as follows:  
For speed limits of 40 mph or less:

$$L = \frac{WS^2}{60}$$

For speed limits of 45 mph or greater:

$$L = WS$$

\* Formulas for L are as follows:

A minimum of 5 channelization devices shall be used in the taper.

TYPE OF TAPER	TAPER LENGTH (L)*
Merging Taper	at least L
Shifting Taper	at least 0.5 L
Shoulder Taper	at least 0.33 L
One-Lane, Two-Way Traffic Taper	100 ft maximum
Downstream Taper	100 ft per lane

#### CHANNELIZATION DEVICE SPACING

The spacing of channelization devices shall not exceed a distance in feet equal to 1.0 times the speed limit in mph when used for taper channelization, and a distance in feet of 2.0 times the speed limit in mph when used for tangent channelization.

#### GENERAL NOTES:

1. Final placement of signs and devices may be changed to fit field conditions as approved by the Resident.
2. Maintain same number of lanes for a shifting taper.
3. Shoulder taper allowed when a minimum of 10 feet can be open from centerline for lane.

Road Type	Distance Between Signs**		
	A	B	C
Urban 30 mph or less	100	100	100
Urban 35 mph and greater	350	350	350
Rural	500	500	500
Expressway / Urban Parkway	1000	1500	2640

\*\*Distances are shown in feet.

#### SUGGESTED BUFFER ZONE LENGTHS

Speed (mph)	Length (feet)	Speed (mph)	Length (feet)
20	115	40	325
25	155	45	360
30	200	50	425
35	250	55	495

SPECIAL PROVISION  
SECTION 812  
SEWER MANHOLE

**Modify Sewer Manhole and Adjust Frame and Cover to Grade**

**Description** This work shall consist of making modifications to sewer manhole and adjusting frame and cover to grade as indicated in the Bid Book, Plans, or as directed by the Resident.

Modify Sewer Manhole shall consist of replacing the frame and cover, removing and re-installing concrete rings, composite riser rings, or brick & mortar and adjusting a manhole frame to the required final grade, slope and height including any temporary lowering for milling and any other adjustments that may be necessary prior to setting the final grade and in accordance with this Section, Standard Specification Section 604 - Manholes, Inlets, and Catch Basins, and Standard Details Section 604.

**Method of Adjustment**

The Contractor shall saw cut the existing pavement for the patch at least two feet away from the nearest edge of the structure.

The existing sewer frame/cover shall be replaced, and bricks or riser rings shall be removed and sewer frame/cover adjustment shall be achieved using concrete rings and mortar. Bricks may be used for shimming and fine adjustments only.

Unless otherwise provided on the plans, mortar for these structures shall meet the requirements of Section 705.02 – Joint Mortar.

Protection from traffic shall be maintained until the mortar is properly cured.

All HMA for patching around adjusted, altered, or rebuilt utility structures shall meet the gradation requirements of a 9.5 mm or 12.5 mm mixture and shall be placed to the full depth of the existing pavement. The Contractor shall place HMA in lifts of 1” or less, as directed by the resident, and compact the HMA using a minimum of a 150 pound plate compactor. HMA for patching around adjusted, altered, or rebuilt utility structures is considered incidental to the respective pay item for adjust, alter, or rebuild utility structure.

All salvaged material not reused (frames, grates, covers and granite curb) for adjustments shall remain the property of the City/District unless otherwise directed.

Each manhole that is modified shall be cleaned of all accumulated silt, debris and other foreign matter before final acceptance of the work and such cleaning shall be considered incidental to the adjust item.

Town: **Randolph - Chelsea**  
Project: **023398.00**  
Date: **January 11, 2018**

Manhole frame finish grade tolerance shall be 0” above and 3/8” below finished pavement grade.

**BUY AMERICA**

Utility construction work performed as part this federal-aid project is subject to the requirements of Buy America in accordance with Federal Regulation 23 CFR 635.410 Section 1518. Specific requirements are presented in Maine DOT Standard Specification Section 100, Appendix A, Section 3.A., Buy America.

**Method of Measurement** Modify Sewer manhole will be measured by the unit price each, complete and in place.

**Basis of Payment** Modify Sewer Manhole item shall be full compensation for all equipment, labor, manhole frames/covers, concrete rings, brick and incidental materials (including pavement) necessary to modify sewer manhole and adjust frame and cover to grade as specified above.

<b><u>Pay Item</u></b>	<b><u>Pay Unit</u></b>
812.163 Modify Sewer Manhole and Adjust Frame and Cover to Grade	Each

SPECIAL PROVISION  
SECTION 812  
SEWER MANHOLE

**Adjusting Sewer Manhole Frame and Cover to Grade**

**Description** This work shall consist of adjusting sewer manhole frame and cover to grade as indicated in the Bid Book, Plans, or as directed by the Resident.

Adjusting Sewer Manhole shall consist of removing the frame and cover, removing and re-installing concrete rings, and adjusting a manhole frame to the required final grade, slope and height including any temporary lowering for milling and any other adjustments that may be necessary prior to setting the final grade and in accordance with this Section, Standard Specification Section 604 - Manholes, Inlets, and Catch Basins, and Standard Details Section 604.

**Method of Adjustment**

The Contractor shall saw cut the existing pavement for the patch at least two feet away from the nearest edge of the structure.

The existing sewer frame/cover, and courses of brick shall be removed and structure thoroughly cleaned. The surface between the remaining structure and the new masonry work shall be scarified, washed and cleaned before constructing the new masonry work. Then add new concrete rings as necessary to reset to the new grade using Portland Type II cement mortar, concrete rings or other materials approved by the Resident. Bricks may be used for adjusting and shimming only.

The exterior face of the concrete grade rings and manhole frames shall be protected with by applying 1 heavy coat of asphalt sealant.

Unless otherwise provided, mortar for these structures shall meet the requirements of Section 705.02 – Joint Mortar.

Protection from traffic shall be maintained until the mortar is properly cured.

All HMA for patching around adjusted, altered, or rebuilt utility structures shall meet the gradation requirements of a 9.5 mm or 12.5 mm mixture. The Contractor shall place HMA in lifts of 1” or less, as directed by the resident, and compact the HMA using a minimum of a 150 pound plate compactor. HMA for patching around adjusted, altered, or rebuilt utility structures is considered incidental to the respective pay item for adjust, alter, or rebuild utility structure.

Each manhole that is adjusted shall be cleaned of all accumulated silt, debris and other foreign matter before final acceptance of the work and such cleaning shall be considered incidental to the adjust item.

Manhole frame finish grade tolerance shall be 0” above and ¼” below finished pavement grade.

**Method of Measurement** Adjusted Sewer manhole will be measured by the unit price each, complete and in place.

**Basis of Payment** Adjusted Sewer Manhole item shall be full compensation for all equipment, labor, concrete rings, brick and incidental materials (including pavement) necessary to adjust the sewer manhole frame and cover to grade as specified above.

<b><u>Pay Item</u></b>	<b><u>Pay Unit</u></b>
812.162 Adjusted Sewer Manhole Frame and Cover to Grade	Each

**SPECIAL PROVISION**  
**SECTION 812**  
**SEWER MANHOLE**

**Rebuild Sewer Manhole**

**Description**

This work shall consist of Rebuilding existing sewer manholes to grade as indicated in the Bid Book, Plans, or as directed by the Resident.

Rebuilding Sewer Manhole shall consist of removing the frame and cover, removing the concrete manhole cone section, installing a new concrete barrel section as necessary and re-installing the manhole cone section and a new manhole frame/cover to the required final grade in accordance with this Section, Standard Specification Section 604 - Manholes, Inlets, and Catch Basins, and Standard Details Section 604.

**Method of Rebuild Sewer Manhole**

The Contractor shall saw cut the existing pavement for the patch at least two feet away from the nearest edge of the structure.

The existing sewer frame/cover, masonry courses of brick and manhole cone section shall be removed and structure thoroughly washed and cleaned. Then add new concrete barrels as necessary and reuse/replace manhole cone section. The surface between the manhole cone and the new masonry work shall be scarified, washed and cleaned before constructing the new masonry work. The new masonry shall be constructed to the new finish grade using concrete rings and Portland Type II cement mortar. Bricks may be used for shimming and adjusting only or as directed by the Resident.

The exterior surface of the manhole cone, new masonry and manhole frames shall be protected by applying 2 coats of asphalt sealant.

Unless otherwise provided, mortar for these structures shall meet the requirements of Section 705.02 – Joint Mortar.

Protection from traffic shall be maintained until the mortar is properly cured.

All HMA for patching around adjusted, altered, or rebuilt utility structures shall meet the gradation requirements of a 9.5 mm or 12.5 mm mixture and shall be placed to the full depth of the existing pavement. The Contractor shall place HMA in lifts of 1” or less, as directed by the resident, and compact the HMA using a minimum of a 150 pound plate compactor. HMA for patching around adjusted, altered, or rebuilt utility structures is considered incidental to the respective pay item for adjust, alter, or rebuild utility structure.

Each manhole that is rebuilt shall be cleaned of all accumulated silt, debris and other foreign matter before final acceptance of the work and such cleaning shall be considered incidental to the adjust item.

Manhole frame finish grade tolerance shall be 0” above and 1/4” below finished pavement grade.

**BUY AMERICA**

Utility construction work performed as part this federal-aid project is subject to the requirements of Buy America in accordance with Federal Regulation 23 CFR 635.410 Section 1518. Specific requirements are presented in Maine DOT Standard Specification Section 100, Appendix A, Section 3.A., Buy America.

**Method of Measurement**

Rebuild Sewer Manhole will be measured by the unit price each, complete and in place.

**Basis of Payment**

Rebuild Sewer Manhole item shall be full compensation for all equipment, labor, concrete cones, concrete barrels, brick, concrete rings, frame/cover and incidental materials (including excavation, backfill and pavement) necessary to adjust the sewer manhole frame and cover to grade as specified above.

**Pay Item**

812.164 Rebuild Sewer Manhole

**Pay Unit**

Each

## STANDARD DETAIL UPDATES

Standard Details and Standard Detail updates are available at:  
<http://maine.gov/mdot/contractors/publications/standarddetail/>

<b><u>Detail #</u></b>	<b><u>Description</u></b>	<b><u>Revision Date</u></b>
501(02)	Pipe Pile Splice	3/05/2015
501(03)	H – Pile Splice	3/05/2015
504(07)	Diaphragm & Crossframe Notes	10/13/2015
505(01)	Shear Connectors	10/24/2016
507(13)	Steel Bridge Railing	6/03/2015
507(14)	Steel Bridge Railing	6/03/2015
507(31)	Barrier – Mounted Steel Bridge	8/06/2015
526(02)	Temporary Concrete Barrier	8/06/2015
652(06)	Construction Signs	10/24/2016
652(12)	Construction Traffic Control	10/24/2016
802(05)	Roadway Culvert End Slope Treatment	1/03/2017
504(10)	Drip Bar Details	9/06/2017

SUPPLEMENTAL SPECIFICATIONS  
(Corrections, Additions, & Revisions to Standard Specifications - November 2014)

**SECTION 101**  
**CONTRACT INTERPRETATION**

101.1 Abbreviations Revise the definition of AWWA to “**American Wood Protection Association**”.

101.2 Definitions

Page 1-5 – Remove the definition of Bridge in its entirety and replace with:

**“Bridge A structure that is erected over a depression or an obstruction, such as water, a highway or a railway, and has an opening measured along the centerline of the Roadway of more than 20 feet between: The faces of abutments; spring line of arches; extreme ends of openings of box culverts, pipes or pipe arches; or the extreme ends of openings for multiple box culverts, pipes or pipe arches.”**

Page 1-12 – Remove the definition of Large Culvert in its entirety and replace with:

**“Large Culvert Any structure not defined as a Culvert or Bridge that provides a drainage or non-drainage opening under the Roadway or Approaches to the Roadway, with an opening that is 5 feet but less than 10 feet.”**

Remove the definition of Minor Span in its entirety and replace with:

**“Minor Span Same definition as Bridge, except having an opening of between 10 feet and 20 feet, inclusive.”**

**SECTION 103**  
**AWARD AND CONTRACTING**

Amend this Section by adding the following:

**“103.1a Tie Bids - In the case where two responsive bids from responsible bidders are equal monetarily, the Department shall determine the apparent low bidder by flipping a coin. The coin shall have sides clearly marked as heads and tails. The contractor whose first letter in their official company name that comes first in the alphabet shall be heads.**

**If there are three bids, each bidder will flip the coin and the bidder with the odd toss will be the winner. (i.e. if the results are two heads and a tails, the bidder who had tails is the winner). For a three way tie, bidders may flip their own coin or have the Contracts Engineer flip for them.**

**The coin flip will occur at the next bid opening by the Contracts and Specifications Engineer or a designee. The tied bidders may attend the coin flip in person or watch on the internet as they choose.”**

In 103.3.2 Notice of Determination Revise this section by removing sections A – M and replacing with the following A - K:

**(A) Default(s) or termination(s) on past or current Contracts.**

**(B) Failure on past or current Contracts to pay or settle all bills for labor, Materials or services;**

**to comply with directives of the Department, to fulfill warranty obligations, or to provide Closeout Documentation.**

**(C) "Below Standard" performance as determined from the Department's Contractor's Performance Rating process.**

**(D) Insufficient bonding capability or Inability of the Contractor to obtain or retain performance or Payment Bonds meeting MDOT requirements, or a pattern of unsupported Claims.**

**(E) Failure to accept an Award of a Contract made by the Department.**

**(F) Failure to provide information requested by the Department in a timely manner.**

**(G) Debarment, suspension or a denial of prequalification or 'award of contract' by any federal, State, or local governmental procurement agency or the Contractor's Agreement to refrain from Bidding as part of the settlement with any such agencies or any of the reasons contained in Section 102.02 of the "Rules Regarding Debarment of Contractors", Maine Department of Transportation Register 17-229, Chapter 102 (October 2, 1985).**

**(H) Failure to demonstrate ability to do work to the satisfaction and at the sole discretion of the Department.**

**(I) Number of personnel working directly for the Contractor with applicable knowledge and experience is significantly below industry standards.**

**(J) Safety Record, Environmental Record, Civil Rights or Equal Opportunity Record significantly below industry standards.**

**(K) Serious misconduct that the Department reasonably determines will substantially and adversely affect the cost, quality or timeliness of Work, or the safety of Workers or the public, any deceptive, evasive or fraudulent statements or omissions contained in the Application, made or omitted at any interview or hearing, or otherwise made to or omitted from the Department; or any other substantial deficiencies in experience or conduct that are clearly below industry standards and that clearly demonstrate in the sole discretion of the Department, that the Contractor is "Not Qualified".**

## **SECTION 104** **GENERAL RIGHTS AND RESPONSIBILITIES**

This Section shall be amended by adding the following two sub-sections:

**104.3.8.1 Electronic Payroll Submission** On federally funded projects the prime contractor, all subcontractors, and lower-tier subcontractors will submit their certified payrolls electronically utilizing the Elations system. There is no charge to the contracting community for the use of this service. The submission of paper payrolls will not be allowed or accepted. Additional information can be found at <http://www.maine.gov/mdot/contractors/> under the “Bidder Info” go to “Electronic Payroll System.”

**104.3.8.2 Payment Tracking** On federally funded projects the prime contractor and all subcontractors and lower-tier subcontractors will track and confirm the delivery and receipt of all payments through the Elation System

**104.4.10 Coordination of Road Closure / Bridge Closure / Bridge Width Restrictions**

Revise the last sentence by adding a period after ‘Resident’; remove the “and” after Resident; and adding “**not covered by Pay Items**” between ‘costs’ and ‘will’. So that the last paragraph reads “**All Newspaper notices, radio announcements and any notifications will be subject to the approval of the Resident. All costs not covered by Pay Items will be considered incidental to the Contract.**”.

**104.5.5 Prompt Payment of Subcontractors** Add the following paragraph to this subsection:

**C. Payment Tracking Federal Projects** On federally funded projects, the prime contractor, subcontractors and lower-tier subcontractors will track and confirm the delivery and receipt of all payments through the Elation System. They will be responsible for entering all payments to all sub and lower tier contractors. MaineDOT will run a query monthly to ensure that contractors are complying and generate an e-mail to contractors who have not responded to confirm receipt of MaineDOT payment or contractor payment to lower tier subcontractors.

## **SECTION 105** **GENERAL SCOPE OF WORK**

**105.2.5 Compliance with Health and Safety Laws** Remove the second paragraph of this subsection in its entirety and replace with:

**“For related provisions, see Sections 105.2.3 – Project Specific Emergency Planning, 105.3 – Traffic Control and Management and 105.4 – Maintenance of work.”**

**105.4.5 Special Detours** Remove this subsection in its entirety and replace with:

**“105.4.5 Maintenance of Existing Structures When a new Bridge or Minor Span is being installed on a new alignment and the existing structure is to remain in service, the Department will maintain the existing structure and the portions of the roadway required for maintaining traffic until such time that the new structure is opened to traffic and the existing structure is taken out of service. A similar situation exists when a new Bridge or Minor Span is being installed on the same alignment as the existing structure, requiring a temporary detour to be installed by the Contractor per Section 510, Special Detours, prior to removal of the existing structure. In this case, the Department will maintain the existing structure and the portions of the existing roadway required for maintaining traffic until such time that either the temporary detour is opened to traffic or the Contractor begins any work on the existing structure, including, but not limited to, repairs, modifications, moving, demolition or removal. In either case, once the new structure or temporary detour is opened to traffic, or the Contractor begins any work on the existing structure, the Contractor shall be solely responsible for all maintenance of the existing structure and the portions of the existing approaches that lie outside the new roadway or the temporary detour, respectively. This specification is not intended to supersede Standard Specification Section 104.3.11, Responsibility for Property of Others.”**

**105.6.2.4 Department Verification Add the following to the end of the first sentence: “or other approved method, such as reference staking, to allow the Department to independently verify the accuracy of the work, as approved by the Department.”**

## **SECTION 106** **QUALITY**

**106.3.4 Storage Revise this Section by adding the following sentence after the first sentence: “Materials shall not be stored under or in close proximity to Highway Structures unless the Contractor receives written permission from the Resident.”**

**106.4.1 General - In the first sentence, remove “When required by Special Provision,” and replace with “When required elsewhere in the Contract,”**

Revise Subsection C by replacing the last sentence with the following:

**Approval of both standard and project specific QCPs shall be as outlined in paragraph B above, with the exception that the initial 14 day review period for standard plans will begin on March 1, and that the supplemental project specific QCP for the project shall be submitted a minimum of 14 days prior to any related work being performed with an initial review period of 7 days.**

**SECTION 108**  
**PAYMENT**

108.3 Retainage - Remove the paragraph beginning with “The Contractor may withdraw...” in its entirety.

108.4.1 Price Adjustment for Hot Mix Asphalt:

Remove this section in its entirety and replace with the following

**For all contracts with hot mix asphalt in excess of 500 tons total, a price adjustment for performance graded binder will be made for the following pay items:**

<b>Item 403.102</b>	<b>Hot Mix Asphalt – Special Areas</b>
<b>Item 403.206</b>	<b>Hot Mix Asphalt - 25 mm</b>
<b>Item 403.207</b>	<b>Hot Mix Asphalt - 19 mm</b>
<b>Item 403.2071</b>	<b>Hot Mix Asphalt - 19 mm (Polymer Modified)</b>
<b>Item 403.2072</b>	<b>Hot Mix Asphalt - 19 mm (Asphalt Rich Base)</b>
<b>Item 403.208</b>	<b>Hot Mix Asphalt - 12.5 mm</b>
<b>Item 403.2081</b>	<b>Hot Mix Asphalt - 12.5 mm (Polymer Modified)</b>
<b>Item 403.209</b>	<b>Hot Mix Asphalt - 9.5 mm (sidewalks, drives, &amp; incidentals)</b>
<b>Item 403.210</b>	<b>Hot Mix Asphalt - 9.5 mm</b>
<b>Item 403.2101</b>	<b>Hot Mix Asphalt - 9.5 mm (Polymer Modified)</b>
<b>Item 403.2102</b>	<b>Hot Mix Asphalt - 9.5 mm (Asphalt Rich Base)</b>
<b>Item 403.2104</b>	<b>Hot Mix Asphalt - 9.5 mm (Thin Lift Surface Treatment)</b>
<b>Item 403.21041</b>	<b>Hot Mix Asphalt - 9.5 mm (Polymer Modified Thin Lift Surface Treatment)</b>
<b>Item 403.211</b>	<b>Hot Mix Asphalt – Shim</b>
<b>Item 403.2111</b>	<b>Hot Mix Asphalt – Shim (Polymer Modified)</b>
<b>Item 403.212</b>	<b>Hot Mix Asphalt - 4.75 mm (Shim)</b>
<b>Item 403.213</b>	<b>Hot Mix Asphalt - 12.5 mm (base and intermediate course)</b>
<b>Item 403.2131</b>	<b>Hot Mix Asphalt - 12.5 mm (base and intermediate course Polymer Modified)</b>
<b>Item 403.2132</b>	<b>Hot Mix Asphalt - 12.5 mm (Asphalt Rich Base and intermediate course)</b>
<b>Item 403.214</b>	<b>Hot Mix Asphalt - 4.75 mm (Surface)</b>
<b>Item 403.235</b>	<b>Hot Mix Asphalt (High Performance Rubberized HMA)</b>
<b>Item 403.301</b>	<b>Hot Mix Asphalt (Asphalt Rubber Gap-Graded)</b>
<b>Item 404.70</b>	<b>Colored Hot Mix Asphalt – 9.5mm (Surface)</b>
<b>Item 404.72</b>	<b>Colored Hot Mix Asphalt – 9.5mm (Islands, sidewalks, &amp; incidentals)</b>
<b>Item 461.13</b>	<b>Light Capital Pavement</b>
<b>Item 461.210</b>	<b>9.5 mm HMA - Paver Placed Surface</b>
<b>Item 462.30</b>	<b>Ultra-Thin Bonded Wearing Course</b>
<b>Item 462.301</b>	<b>Polymer Modified Ultra-Thin Bonded Wearing Course</b>

**Price adjustments will be based on the variance in costs for the performance graded binder component of hot mix asphalt. They will be determined as follows:**

The quantity of hot mix asphalt for each pay item will be multiplied by the performance graded binder percentages given in the table below times the difference in price between the base price and the period price of asphalt cement. Adjustments will be made upward or downward, as prices increase or decrease.

- Item 403.102–6.2%
- Item 403.206–4.8%
- Item 403.207–5.2%
- Item 403.2071–5.2%
- Item 403.2072–5.8%
- Item 403.208–5.6%
- Item 403.2081–5.6%
- Item 403.209–6.2%
- Item 403.210–6.2%
- Item 403.2101–6.2%
- Item 403.2102–6.8%
- Item 403.2104–6.2%
- Item 403.21041–6.2%
- Item 403.211–6.2%
- Item 403.2111–6.2%
- Item 403.212–6.8%
- Item 403.213–5.6%
- Item 403.2131–5.6%
- Item 403.2132–6.2%
- Item 403.214–6.8%
- Item 403.235–5.5%
- Item 403.301–6.2%
- Item 404.70–6.2%
- Item 404.72–6.2%
- Item 461.13–6.5%
- Item 461.210 – 6.4%
- Item 462.30–0.0021 tons/SY
- Item 462.301–0.0021 tons/SY

**Hot Mix Asphalt:** The quantity of hot mix asphalt will be determined from the quantity shown on the progress estimate for each pay period.

**Base Price:** The base price of performance graded binder to be used is the price per standard ton current with the bid opening date. This price is determined by using the average New England Selling Price (Excluding the Connecticut market area), as listed in the Asphalt Weekly Monitor.

**Period Price:** The period price of performance graded binder will be determined by the Department by using the average New England Selling Price (Excluding the Connecticut market area), listed in the Asphalt Weekly Monitor current with the paving date. The maximum Period Price for paving after the adjusted Contract Completion Date will be the Period Price on the adjusted Contract Completion Date.

## **SECTION 109** **CHANGES**

### 109.5.1 Definitions - Types of Delays

Delete Paragraph 'A' in its entirety and replace with:

**"A. Excusable Delay** Except as expressly provided otherwise by this Contract, an "Excusable Delay" is a Delay to the Critical Path that is directly and solely caused by (1) a weather related Event of such an unusually severe nature that a Federal Emergency Disaster is declared. The Contractor will only be entitled to an adjustment of time if the Project falls within the geographic boundaries prescribed under the disaster declaration. or (2) a flooding event at the effected location of the Project that results in a Q25 headwater elevation, or greater, but less than a Q50 headwater elevation. Theoretical headwater elevations will be determined by the Department; actual headwater elevations will be determined by the Contractor and verified by the Department or (3) An Uncontrollable Event."

## **APPENDIX A TO DIVISION 100**

Remove Section D in its entirety as this is now covered in Section 105.10 EQUAL OPPORTUNITY AND CIVIL RIGHTS.

## **SECTION 203** **EXCAVATION AND EMBANKMENT**

### 203.02 Materials

At the bottom of page 2-12, add as the first item in the list:

**Crushed Stone, ¾ inch      703.13**

### 203.042 Rock Excavation and Blasting

On page 2-16, add the word "No" to the third sentence in Section 5 Submittals, Subsection V, 1 so that it reads:

**"No blasting products will be allowed on the job site if the date codes are missing."**

**SECTION 304**  
**AGGREGATE BASE AND SUBBASE COURSE**

**304.02 – Aggregate** Add the following sentence before the sentence starting with “When designated on the plans...”: **“Aggregate Base Course – Type C will be capped with 2” of millings or Untreated Aggregate Surface Course – Type B. Payment for this material will be made under 304.16”**

Revise the sentence beginning “When designated on the Plans, Type E...” by removing “When designated on the Plans,” so it reads **“Type E subbase may be used 9 inches below and lower beneath the pavement.”**

**SECTION 307**  
**FULL DEPTH RECYCLED PAVEMENT**

Remove this Section in its entirety and replace with:

**SECTION 307**  
**FULL DEPTH RECYCLING**  
**(UNTREATED OR TREATED WITH EMULSIFIED ASPHALT STABILIZER)**

**307.01 Description** This work shall consist of pulverizing a portion of the existing roadway structure into a homogenous mass, adding an emulsified asphalt stabilizer (if required) to the depth of the pulverized material specified in the contract, placing and compacting this material to the lines, grades, and dimensions shown on the plans or established by the Resident.

**MATERIALS**

**307.02 Pulverized Material** Pulverized material shall consist of the existing asphalt pavement layers and one inch or more as specified of the underlying gravel, pulverized and blended into a homogenous mass. Pulverized material will be processed to 100% passing a 2 inch square mesh sieve.

**307.021 New Aggregate and Additional Recycled Material** New aggregate, if required by the contract, shall meet the requirements of Subsection 703.10 - Aggregate for Untreated Surface Course and Leveling Course, Type A. Aggregate Subbase Course Gravel Type D processed to 100 percent passing a 2 inch square mesh sieve and meeting the requirements of 703.06 – Aggregate for Base and Subbase may be used in areas requiring depths greater than 2 inches. New aggregate, will be measured and paid for under the appropriate item.

Recycled material, if required, shall consist of salvaged asphalt material from the project or from off-site stockpiles that has been processed before use to 100 percent passing a 2 inch square mesh sieve. Recycled material shall be conditionally accepted at the source by the Resident. It shall be free of winter sand, granular fill, construction debris, or other materials not generally considered asphalt pavement.

Recycled material generated and salvaged from the project shall be used within the roadway limits to the extent it is available as described in 307.09. No additional payment will be made for material salvaged from the project.

Recycled material supplied from off-site stockpiles shall be paid for as described in the contract, or by contract modification.

**307.022 Emulsified Asphalt Stabilizer.** If required, the emulsified asphalt stabilizer shall be grade MS-2, MS-4, SS-1, or CSS-1 meeting the requirements of Subsection 702.04 Emulsified Asphalt.

**307.023 Water** Water shall be clean and free from deleterious concentrations of acids, alkalis, salts or other organic or chemical substances.

**307.024 Portland Cement** If required, Portland Cement shall be Type I or II meeting the requirements of AASHTO M85.

**307.025 Hydrated Lime** If required, Hydrated Lime shall meet the requirements of AASHTO M216.

## EQUIPMENT

**307.03 Pulverizer** The pulverizer shall be a self-propelled machine, specifically manufactured for full-depth recycling work and capable of reducing the required existing materials to a size that will pass a 2 inch square mesh sieve. The machine shall be equipped with standard automatic depth controls and must maintain a consistent cutting depth and width. The machine also shall be equipped with a gauge to show depth of material being processed.

**307.04 Liquid Mixer Unit or Distributor.** If treatment of the recycled layer with emulsified asphalt is required by the contract, a liquid mixing unit or distributor shall be used to introduce the emulsified asphalt stabilizer into the pulverized material. The mixing unit shall contain a liquid distribution and mixing system which has been specifically manufactured for full-depth recycling work, capable of mixing the pulverized material with an evenly metered distribution of emulsified asphalt into a homogeneous mixture, to the depth and width required.

The mixing unit shall be designed, equipped, maintained, and operated so that emulsified asphalt stabilizer at constant temperature may be applied uniformly on variable widths of pulverized material up to 6 feet at readily determined and controlled rates from 0.01 to 1.06 gal/yd<sup>2</sup> with uniform pressure and with an allowable variation from any specified rate not to exceed 0.01 gal/ yd<sup>2</sup>. Mixing units shall include a tachometer, pressure gages, and accurate volume measuring devices or a calibrated tank and a thermometer for measuring temperatures of tank contents.

**307.041 Cement or Lime Spreader** If required by the contract, spreading of the Portland Cement or Hydrated Lime shall be done with a spreader truck designed to spread dry particulate (such as Portland Cement or Lime) or other approved means to insure a uniform distribution across the roadway and minimize fugitive dust. Pneumatic application, including through a slotted pipe, will not be permitted. Other systems that have been developed include fog systems, vacuum systems, etc. Slurry applications may also be accepted. The Department reserves the right to accept or reject the method of spreading cement. The Contractor shall provide a method for verifying that the correct amount of cement is being applied.

**307.05 Placement Equipment** Placement of the Full Depth recycled material to the required slope and grade shall be done with an approved highway grader or by another method approved by the Resident.

**307.06 Rollers** The full depth recycled material shall be rolled with a vibratory pad foot roller, a vibratory steel drum soil compactor and a pneumatic tire roller. The pad foot roller drum shall have a minimum of 112 tamping feet 3 inches in height, a minimum contact area per foot of 17 inch<sup>2</sup>, and a minimum width of 84 inches. The vibratory steel drum roller shall have a minimum 84 inch width single drum. The pneumatic tire roller shall meet the requirements of Section 401.10 and the minimum allowable tire pressure shall be 85 psi.

## MIX DESIGN

If treatment of the recycled layer with emulsified asphalt is required by the contract, the Department will supply a mix design for the emulsified asphalt stabilized material based on test results from pavement and soil analysis taken to the design depth. The Department will provide the following information prior to construction:

1. Percent of emulsified asphalt to be used.
2. Quantity of lime or cement to be added.
3. Optimum moisture content for proper compaction.
4. Additional aggregate (if required).

After a test strip has been completed or as the work progresses, it may be necessary for the Resident to make necessary adjustments to the mix design. Changes to compensation will be in accordance with the Mix Design Special Provision.

## CONSTRUCTION REQUIREMENTS

**307.06 Pulverizing** The entire depth of existing pavement shall be pulverized together with 1 inch or more of the underlying gravel into a homogenous mass. All pulverizing shall be done with equipment that will provide a homogenous mass of pulverized material, processed in-place, which will pass a 2 inch square mesh sieve.

**307.07 Weather Limitations** Full depth recycled work shall be performed when;

- A. Recycling operations will be allowed between May 15<sup>th</sup> and September 15<sup>th</sup> inclusive in Zone 1 - Areas north of US Route 2 from Gilead to Bangor and north of Route 9 from Bangor to Calais.
- B. The atmospheric temperature, as determined by an approved thermometer placed in the shade at the recycling location, is 50°F and rising.
- C. When there is no standing water on the surface.
- D. During generally dry conditions, or when weather conditions are such that proper pulverizing, mixing, grading, finishing and curing can be obtained using proper procedures, and when compaction can be accomplished as determined by the Resident.
- E. When the surface is not frozen and when overnight temperatures are expected to be above 32°F.
- F. Wind conditions are such that the spreading of lime or cement on the roadway ahead of the recycling machine will not adversely affect the operation.

**307.08 Surface Tolerance** The complete surface of the Full Depth Recycled course shall be shaped and maintained to a tolerance, above or below the required cross sectional shape, of  $\frac{3}{8}$  inch.

**307.09 Full Depth Recycling Procedure** New aggregate or recycled material meeting the requirements of Section 307.021 - New Aggregate and Additional Recycled Material, shall be added as necessary to restore cross-slope and/or grade before pulverizing. Locations will be shown on the plans or described in the construction notes. The Resident may add other locations while construction of the project is in progress. The Contractor will use recycled material to the extent it is available, in lieu of new aggregate. The material shall then be pulverized, processed, and blended into a homogeneous mass passing a 2 inch square mesh sieve. Material found not pulverized down to a 2 inch size will be required to be reprocessed by the recycler with successive passes until approved by the Resident.

Should the Contractor be required to add new aggregate or recycled material to restore cross-slope and/or grade after the initial pulverizing process, those areas will require re-processing to blend into a homogenous mass passing a 2 in square mesh sieve.

Sufficient water shall be added during the recycling process to maintain optimum moisture for compaction.

The resultant material from the initial pulverizing processes shall be graded and compacted to the cross-slope and profile shown on the plans or as directed by the Resident. The Contractor will also be responsible for re-establishing the existing profile grade. The completed surface of the full depth recycled course shall be shaped and maintained to a tolerance, above or below the required cross sectional shape, of  $\frac{3}{8}$  inch. Areas not meeting this tolerance will be repaired as described in Section 307.091. The initial pulverizing process density requirements will be the same as Section 307.101 unless otherwise directed by the Resident.

Additives, if required, shall be introduced following completion of the initial pulverizing and blending process. Emulsified asphalt stabilizer shall be incorporated into the top of the processed material as specified in section 307.04 to the depth specified in the contract by use of the liquid mixer unit or a distributor, at the rate specified in the mix design. The emulsified asphalt shall then be uniformly blended into a homogeneous mass until an apparent uniform distribution has occurred. The rate of application may be adjusted as necessary by the Resident. Cement or lime shall be introduced as described in section 307.041. The resultant material shall be graded and compacted to the cross-slope and profile shown on the plans or as directed by the Resident. The Contractor will also be responsible for re-establishing the existing profile grade.

After final compaction, the roadway surface shall be treated with a light application of water, and rolled with pneumatic-tired rollers to create a close-knit texture. The finished layer shall be free from:

- A. Surface laminations.
- B. Segregation of fine and coarse aggregate.
- C. Corrugations, centerline differential, potholes, or any other defects that may adversely affect the performance of the layer, or any layers to be placed upon it.

The Contractor shall protect and maintain the recycled layer until a lift of pavement is applied. Any damage or defects in the layer shall be repaired immediately. An even and uniform surface shall be maintained. The recycled surface shall be swept prior to hot mix asphalt overlay placement.

**307.091 Repairs** Repairs and maintenance of the recycled layers, resulting from damage caused by traffic, weather or environmental conditions, or resulting from damage caused by the Contractor's operations or equipment, shall be completed at no additional cost to the Department.

For recycled layers stabilized with emulsified asphalt, low areas will be repaired using a hot mix asphalt shim. Areas up to 1 inch high can be repaired by milling or shimming with hot mix asphalt. Areas greater than 1 inch high will be repaired using a hot mix asphalt shim. All repair work will be done with the Resident's approval at the Contractor's expense.

## TESTING REQUIREMENTS

**307.10 Quality Control** The Contractor shall operate in accordance with the approved Quality Control Plan (QCP) to assure a product meeting the contract requirements. The QCP shall meet the requirements of Section 106.4 - Quality Control and this Section. The Contractor shall not begin recycling operations until the Department approves the QCP in writing. Prior to performing any recycling process, the Department and the Contractor shall hold a Pre-recycle conference to discuss the recycling schedule, type and amount of equipment to be used, sequence of operations, and traffic control. A copy of the QC random numbers to be used on the project shall be provided to the Resident. All field supervisors including the responsible onsite recycling process supervisor shall attend this meeting.

The QCP shall address any items that affect the quality of the Recycling Process including, but not limited to, the following:

- A. Sources for all materials, including New Aggregate and Additional Recycled Material.
- B. Make and type of rollers including weight, weight per inch of steel wheels, and average contact pressure for pneumatic tired rollers.
- C. Testing Plan.
- D. Recycling operations including recycling speed, methods to ensure that segregation is minimized, grading and compacting operations.
- E. Methods for protecting the finished product from damage and procedures for any necessary corrective action.
- F. Method of grade checks.
- G. Examples of Quality Control forms.
- H. Name, responsibilities, and qualifications of the Responsible onsite Recycling Supervisor experienced and knowledgeable with the process.
- I. A note that all testing will be done in accordance with AASHTO and MDOT/ACM procedures.

The Project Superintendent shall be named in the QCP, and the responsibilities for successful implementation of the QCP shall be outlined.

The Contractor shall sample, test, and evaluate the full depth reclamation process in accordance with the following minimum frequencies:

**MINIMUM QUALITY CONTROL FREQUENCIES**

Test or Action	Frequency	Test Method
Density	1 per 1000 feet / lane	AASHTO T 310
Air Temperature	4 per day at even intervals	
Surface Temperature	At the beginning and end of each days operation	
Yield of all materials (Daily yield, yield since last test, and total project yield.)	1 per 1000 ft/lane	

The Department may view any QC test and request a QC test at any time. The Contractor shall submit all QC test reports and summaries in writing, signed by the appropriate technician, to the Department’s onsite representative by 1:00 P.M. on the next working day, except when otherwise noted in the QCP due to local restrictions. The Contractor shall make all test results, including randomly sampled densities, available to the Department onsite.

The Contractor shall cease recycling operations whenever one of the following occurs:

- A. The Contractor fails to follow the approved QCP.
- B. The Contractor fails to achieve 98 percent density after corrective action has been taken.
- C. The finished product is visually defective, as determined by the Resident.
- D. The computed yield differs from the mix design by 10 percent or more.

Recycling operations shall not resume until the Department approves the corrective action to be taken.

**307.101 Test Strip** The contractor shall assemble all items of equipment for the recycling operation on the first day of the recycling work. The Contractor shall construct a test strip for the project at a location approved by the Resident. The Responsible onsite Recycling Supervisor will work with Department personnel to determine the suitability of the mixed material, moisture control within the mixed material, and compaction and surface finish. The test strip section is required to:

- A. Demonstrate that the equipment and processes can produce recycled layers to meet the requirements specified in these special provisions.
- B. Determine the effect on the gradation of the recycled material by varying the forward speed of the recycling machine and the rotation rate of the milling drum.

- C. Determine the optimum moisture necessary to achieve proper compaction of the recycled layer.
- D. Determine the sequence and manner of rolling necessary to obtain the compaction requirements and establish a target density. The Contractor and the Department will both conduct testing with their respective gauges at this time.

The test strip shall be at least 300 feet in length of a full lane-width (or a half-road width). Full recycling production will not start until a passing test strip has been accomplished. If a test strip fails to meet the requirements of this specification, the Contractor will be required to repair or replace the test strip to the satisfaction of the Resident. Any repairs, replacement, or duplication of the test strip will be at the Contractor's expense.

After the test strip has been pulverized, and the roadway brought to proper shape, the Contractor shall add water until it is determined that optimum moisture has been obtained. The test strip shall then be rolled using the specified compaction equipment as directed until the density readings show an increase in dry density of less than 1 pcf for the final four roller passes of each roller. The Contractor and Department will each determine a target density using their respective gauges by performing several additional density tests and averaging them. The average of these tests will be used as the target density of the recycled material for QC and Acceptance purposes.

Following completion of the test strip, compaction of the material shall continue until a density of not less than 98 percent of the test strip target density has been achieved for the full width and depth of the layer. During the construction and compaction of the Full Depth Recycled base, should three consecutive Acceptance test results for density fail to meet a minimum of 95 percent of the target density, or exceed 102 percent of target density, a new test strip shall be constructed.

#### ACCEPTANCE TEST FREQUENCY

Property	Frequency	Test Method
In-place Density	1 per 2000 ft / lane	AASHTO T 310

**308.102 Curing.** No new pavement shall be placed on the full depth recycled pavement until curing has reduced the moisture content to 1 percent or less by total weight of the mixture, or a curing period of 4 days has elapsed, whichever comes first.

**307.11 Method of Measurement** Full Depth Recycled Pavement (Untreated or Treated with Emulsified Asphalt Stabilizer) will be measured by the square yard.

**307.12 Basis of Payment** The accepted quantity of Full Depth Recycled Asphalt Pavement (Untreated or Treated with Emulsified Asphalt Stabilizer) will be paid for at the contract unit price per square yard, complete in-place which price will be full compensation for furnishing all equipment, materials and labor for pulverizing, blending, placing, grading, compacting, and for all incidentals necessary to complete the work.

The addition of materials to restore profile grade and/or cross-slope in areas shown on the plans or described in the construction notes will be paid separately under designated pay items within the contract. No additional payment will be made for materials salvaged from the project.

Payments will be made under:

<b><u>Pay Item</u></b>	<b><u>Pay Unit</u></b>
<b>307.331 Full Depth Recycled Pavement (Untreated)</b>	<b>Square Yard</b>
<b>307.332 Full Depth Recycled Pavement (with Emulsified Asphalt Stabilizer) 5 in. depth</b>	<b>Square Yard</b>
<b>307.333 Full Depth Recycled Pavement (with Emulsified Asphalt Stabilizer) 6 in. depth</b>	<b>Square Yard</b>

**SECTION 411**  
**UNTREATED AGGREGATE SURFACE COURSE**

411.02 – Aggregate Add the following to the end of the first sentence: “- Type A”

**SECTION 501**  
**FOUNDATION PILES**

501.05 – Method of Measurement

- b. Piles Furnished – After the second sentence, add the sentence “**Measurement will not include any pile tips**”.
- c. Piles in Place – Add the sentence to the end of the second paragraph, “**Measurement will include the pile tips**”.
- d. Pile Tips – Add the words “**on the Pile**” to the end of the sentence.

**SECTION 502**  
**STRUCTURAL CONCRETE**

502.05 Composition and Proportioning

Replace Table 1 with

TABLE 1

Concrete CLASS	Minimum Compressive Strength (PSI)	Permeability as indicated by Surface Resistivity (KOhm-cm)	Entrained Air (%)		Notes
			LSL	USL	
S	3,000	LSL	LSL	USL	4,5
		N/A	N/A	N/A	
A	4,000	14	6.0	9.0	1,4,5
P	-----	-----	5.5	7.5	1,2,3,4
LP	5,000	17	6.0	9.0	1,4,5
Fill	3,000	N/A	6.0	9.0	4,5

In the list of information submitted by the contractor for a mix design:

Item J Replace “Target Coulomb Value.” with “Target KOhm-cm Value.”

**Note #1** - Remove, “...**Standard Specification Section 711.05, Protective Coating for Concrete Surfaces, and per the manufacturer’s recommendations, at no additional cost to the Department.**” and replace with, “...**Standard Specification Section 515, Protective Coating for Concrete Surfaces, at no additional cost to the Department.**”

502.1703 Acceptance Methods A and B

In the paragraph that starts with “The Department will take Acceptance...” Remove the word chloride from chloride permeability in the last sentence.

Replace the paragraph starting with “Rapid Chloride Permeability specimens...” With the following:

“Surface Resistivity specimens will be tested by the Department in accordance with AASHTO TP-95 at an age  $\geq$  56 days. Four 4 inch x 8 inch cylinders will be cast per subplot placed. The average of three concrete specimens per subplot will constitute a test result and this average will be used to determine the permeability for pay adjustment computations.”

502.1706 Acceptance Method C

Remove in its entirety and Replace with:

**502.1706 Acceptance Method C** The Department will determine the acceptability of the concrete through Acceptance testing. Acceptance tests will include compressive strength, air content and permeability. Method C concrete not meeting the requirements listed in Table 1 shall be removed and replaced at no cost to the Department. At the Department’s sole discretion, material not meeting requirements may be left in place and paid for at a reduced price as described in Section 502.195.

502.1707 Resolution of Disputed Acceptance Test Results  
Section B

Remove “Rapid Chloride” from the section heading.  
In paragraph 4 replace T-277 with TP-95

502.192 Pay Adjustment for Chloride Permeability

Remove “Chloride” from the heading and from the first sentence.

Replace the sentence that starts with “values greater than...” and replace with “values less than 10 KOhms-cm for Class A concrete or 11 KOhms-cm for Class LP concrete shall be subject to rejection and replacement, at no additional cost to the Department.”

502.194 Pay Adjustments for Compressive Strength, Chloride Permeability and Air Content, Methods A and B

Remove the word “Chloride” from the section heading and from the equation for CPF.

502.195 Pay Adjustment Method C

In Table 6: Method C Pay Reductions (page 5-53)  
Under “Entrained Air” for “Class Fill”, in the first line,  
change from “< 4.0 (Removal)” to “< 4.5 (Removal)”

In Table 6: Method C PAY REDUCTIONS, revise the Chloride Permeability section by removing it in its entirety and replacing it with:

Surface Resistivity {Permeability in Kohm-cms and Pay Reduction per CY}			
15-16 (\$50)	13 (\$25)	N/A	N/A
13-14 (\$75)	12(\$50)	N/A	N/A
12 (\$100)	11 (\$75)	N/A	N/A
11 (\$125)	10 (\$100)	N/A	N/A
< 11 (Removal)	< 10 (Removal)	N/A	N/A

## **SECTION 503** **REINFORCING STEEL**

503.06 Placing and Fastening Revise this Subsection by removing, in its entirety, the paragraph which begins, “Stainless steel reinforcement shall not be tied to any other type of reinforcement.....”

## **SECTION 504** **STRUCTURAL STEEL**

504.26 Welding Remove the second paragraph beginning with “The range of heat....” in its entirety.

504.29 Welding ASTM A 709 HPS 70W Steel. Remove the third paragraph beginning with “Make Weld runoff tabs...” in its entirety.

## **SECTION 510** **SPECIAL DETOURS**

510.032 Geometric and Approach Design a. Horizontal alignment  
The third paragraph of this section is revised to read as follows:

“The roadway width shall be increased on curved portions of the Special Detour to account for the off tracking characteristics of WB-62 vehicle in accordance with **the AASHTO publication A Policy On Geometric Design of Highways and Streets (the Green Book), chapter 3 table entitled Design Widths of Pavements for Turning Roadways.**”

## **SECTION 527** **ENERGY ABSORBING UNIT**

527.02 Materials This section is revised to read as follows.

527.02 Materials Work Zone Crash Cushions must comply with NCHRP Report 350. Work Zone Crash Cushions shall be selected from MaineDOT’s Qualified Products List of Crash Cushions / Impact Attenuators, or an approved equal.

## **SECTION 534** **PRECAST STRUCTURAL CONCRETE**

534.14 Process Control Test Cylinders  
Revise this subsection to read:

“**534.14 Acceptance and Quality Control Testing of Concrete Refer to Section 712.061.**”

## **SECTION 535** **PRECAST, PRESTRESSED CONCRETE SUPERSTRUCTURE**

### Section 535.08 – Quality Assurance

Revise the second paragraph to read:

**“The QAI will perform acceptance sampling and testing and will witness or review documentation, workmanship and testing to assure the Work is being performed in accordance with the Contract Documents.”**

### Section 535.15 - Process Control Test Cylinders

Revise the first paragraph to read:

**“535.15 Acceptance and Quality Control Testing of Concrete Acceptance of structural precast/prestressed units, for each day’s production, will be determined by the Department, based on compliance with this specification and satisfactory concrete testing results. At least once per week, the QAI will make 2 concrete cylinders (6 cylinders when the Contract includes permeability requirements) for use by the Department; cylinders shall be standard cured in accordance with AASHTO T23 (ASTM C31). The QAI will perform entrained air content and slump flow testing, determine water-cement ratio and determine temperature of the sampled concrete at the time of cylinder casting. All testing equipment required by the QAI to perform this testing shall be provided in accordance with Standard Specification Section 502.041, Testing Equipment. In addition, the Contractor shall provide a slump cone meeting the requirements of AASHTO T 119. Providing and maintaining testing and curing equipment shall be considered incidental to the work and no additional payment will be made.”**

Insert the following as the second paragraph of Section 535.15:

**“Quality Control concrete test cylinders shall be made for each day’s cast and each form bed used. Cylinders tested to determine strand release strength and design strength shall be field cured in accordance with AASHTO T23 (ASTM C31). 28 day cylinders shall be standard cured. Record unit identification, entrained air content, water-cement ratio, slump flow and temperature of the sampled concrete at the time of cylinder casting.”**

## **SECTION 604** **MANHOLES, INLETS CATCH BASINS**

### 604.04 Adjusting Catch Basins and Manholes,

Add the following paragraph to the end of 604.04 b:

**The Department will allow the use of metal ring inserts set into the manhole top frame or composite risers placed beneath the manhole frame to adjust manhole slope and grade for paving projects. The use of metal ring inserts shall be in accordance with 604.04 d. Ring Insert Requirements. The use of composite risers shall be in accordance with 604.04 e. Composite Riser Requirements.**

Add the following paragraph after the first paragraph of 604.04 c:

**The Department will allow the use of metal ring inserts set into the manhole top frame or composite risers placed beneath the manhole frame to adjust manhole slope and grade for paving projects. The use of metal ring inserts shall be in accordance with 604.04 d. Ring Insert Requirements. The use of composite risers shall be in accordance with 604.04 e. Composite Riser Requirements.**

Add the following sections to 604.04:

**d. Ring Insert Requirements Ring inserts to adjust manhole top frame slope and grade will be allowed in accordance with the following requirements:**

**1) Materials**

- i. All ring inserts must be made of iron. *Multiple ring inserts will not be allowed.* The single ring insert may be any height up to a maximum of 2 inches tall.**
- ii. Ring inserts shall not be welded to the manhole frame to prevent brittle failure of the cast iron frame.**
- iii. Ring inserts shall be fastened to the manhole frame using liquid steel-filled epoxy such as Loctite Fixmaster Steel Liquid or equivalent. The epoxy shall be installed in accordance with the manufacturer's recommendations.**

**2) Where Ring Inserts May/May Not Be Used**

- i. MaineDOT will allow the use of a single manhole ring insert to raise manholes on state and state-aid highways.**
- ii. *Manhole ring inserts may not be used along state and state-aid highway sections where the speed limit is 40 miles per hour or more.* The standard brick and mortar or flat composite risers beneath the manhole frame must be used at these locations.**

### 3) Construction Requirements For The Use of Iron Manhole Ring Inserts

- i. Wherever iron ring inserts are used to raise manhole top elevations, the rings shall be fastened to the existing manhole frame using liquid steel-filled epoxy. The liquid steel-filled epoxy shall be placed evenly around the entire manhole frame before placing the ring insert. *Unbonded ring inserts will not be allowed.* If the manufacturer's recommended construction practices result in loose or unacceptable manhole cover restraint, standard brick and mortar or flat composite risers beneath the manhole frame must be used at these locations.

**e. Composite Riser Requirements** Flat or beveled, doughnut-shaped, composite risers placed beneath the manhole frame to adjust slope and grade are allowed. The composite riser shall be fastened to both the top of the concrete cone and bottom of the manhole frame with the manufacturer's recommended epoxy. Composite risers may be used at all locations on state and state-aid highways under any legal speed limit without restriction.

## **SECTION 606** **GUARDRAIL**

**606.09 Basis of Payment** Amend the first sentence of the eighth paragraph of this subsection by removing the word "meter" and replace it with "linear foot".

## **SECTION 608** **SIDEWALKS**

**608.021 Sidewalk Materials** Revise this section by removing the second paragraph which begins with "Portland cement concrete shall..." in its entirety and replace with "**Portland cement concrete shall be Class A and meet the requirements of Section 502, Structural Concrete.**"

## **SECTION 609** **CURB**

**609.03 Vertical Stone Curb, Terminal Section and Transition Sections and Portland Cement Concrete Curb, Terminal Sections and Transition Sections**

Amend this section by adding the following paragraph to the end of it:

**"The Contractor may elect to substitute concrete to backfill Stone Curbing or Stone Edging at their option. If the concrete backfill option is elected, the following is added to Standard Specification 609 – Curb"**

609.02 Materials Amend this section by adding the following to it:

<b>Portland cement and Portland Pozzolan Cement</b>	<b>701.01</b>
<b>Water</b>	<b>701.02</b>
<b>Fine Aggregate for Concrete</b>	<b>703.01</b>
<b>Coarse Aggregate for Concrete</b>	<b>703.02</b>

**The Contractor shall submit a concrete mix design for the Portland Cement Concrete to the Resident, with a minimum designed compressive strength of 4000 psi Class A concrete.**

609.10 Basis of Payment Revise by changing the fifth paragraph which begins with “There will be no separate payment...” this section by removing the word “cement” and replacing it with “**concrete fill, mortar**”.

## **SECTION 619** **MULCH**

619.07 Basis of Payment Amend this section by adding the words “; **Bark Mulch and Erosion Control Mix will be paid for by the Cubic Yard;**” into the first sentence so that it reads:

“The accepted areas mulched will be paid for at the contract price per unit; **Bark Mulch and Erosion Control Mix will be paid for by the Cubic Yard;** which shall be full compensation for furnishing and spreading the hay or straw and mulch binder, cellulose fiber mulch, bark mulch or erosion control mix.

Revise the second sentence by removing “ **for pay item 619.1201**” So that it reads:

**“When Mulch is measured in Bales, each bale will be paid for at 60% of the contract price per Unit”.**

Revise this section by removing all pay items and replace them with the following:

<b>619.12 Mulch</b>	<b>Unit</b>
<b>619.13 Bark Mulch</b>	<b>Cubic Yard</b>
<b>619.14 Erosion Control Mix</b>	<b>Cubic Yard</b>

## **SECTION 621** **LANDSCAPING**

621.0002 Materials - General

In the list of items change “Organic Humus” to “**Humus**”.

621.0019 Plant Pits and Beds

c Class A Planting

In the third paragraph beginning with “ The plant pit...” change “½ inch” to “**1 inch**”

**SECTION 626**  
**FOUNDATIONS, CONDUIT AND JUNCTION BOXES FOR HIGHWAY  
SIGNING, LIGHTING AND SIGNALS**

626.02 General Amend the Material list by adding the following to the list:

Gravel Borrow	703.20
---------------	--------

Revise the Material List by removing:

Prewired Conduit	715.04
Metallic Junction and Fuse Box	715.05

626.021 Miscellaneous Material Amend this section by adding the following to the end of it:

**“All concrete for concrete encasement of conduit shall be Fill Class concrete in accordance with the applicable requirements of Section 502 – Structural Concrete.”**

Amend the third paragraph that begins with “If grouting is necessary...” by adding “**included on the Qualified Product List and**” after the word “material”.

626.03 General Amend this section by adding the following section to the end of it

**“626.0301 Electrical Supply Lines and Service Connections The following requirements shall apply to Electric Supply Lines and Service Connections feeding traffic signalization equipment control boxes and lighting breaker boxes.**

**Whenever possible, the meter and breaker panel feeding traffic signal control boxes or lighting control boxes shall be constructed within 30 feet of the service drop pole.**

**All service connections to MaineDOT traffic signal control boxes or lighting breaker boxes constructed in trenches shall be in steel conduit or concrete encased PVC conduit.**

**Where trenchless technologies are employed to install the service connection conduit, Schedule 120 PVC conduit shall be used for the trenchless bore section of conduit. In addition, concrete encasement shall be used for any conduit placed in trench sections more than 10 feet before or after the limits of the trenchless bore conduit.**

**The construction practices described above shall be used for service connections up to a maximum of 600 feet. There may be rare exceptional cases where the service connection must exceed 600 feet. In these cases, the power companies may require primary power be run over 600 feet for the purpose of power consumption and dependable service. These cases will be evaluated on a case-by-case basis for alternate power feed methods and/or the need for steel or concrete encased conduit.”**

626.031 Conduit Revise this section by removing the second paragraph which begins with “Trenches for conduits...” and replace it with the following:

**“Trenches for conduits shall be excavated to a width that will permit proper installation of the conduit and to a minimum depth of 3 feet below finish grade as measured from the top of the conduit. If deeper depths are required, the conduit shall be installed at the depth shown on the plans or as directed. Conduit shall not interfere with poles, guardrail posts, sign foundations or other objects.”**

Amend the third paragraph which begins with “All junction or pull boxes...” by adding “**concrete, in accordance with the applicable requirements of Section 502 – Structural Concrete,**” after Class LP.

Revise the fifth paragraph which begins with “After the trench has been...” by adding the following to the end of it:

**“Where concrete encasement is required around the conduit, backfilling with approved material may begin adjacent to and above the encased conduit no sooner than 24 hours after concrete placement.”**

Remove the following:

**“All underground conduit shall be placed to at least the depth shown on the plans and shall not interfere with poles, guardrail posts, sign foundations or other objects.”**

Revise the paragraph beginning with “All conduit ends shall...” by removing “Prewired Conduit shall be sealed during construction to prevent entry of moisture, dirt, or rocks.”

626.033 Polyvinylchloride Conduit Installation Amend the first paragraph of this section which begins with “Polyvinylchloride conduit and High Density...” by adding the following to the end of it:

**“In addition, PVC conduit used for Electrical Supply Lines and Services feeding control cabinets for traffic signalization equipment or highway lighting breaker boxes shall be concrete encased. When trenchless technologies are used to install PVC conduit, concrete encasement shall not be required.**

Concrete encasement shall consist of a minimum of 4 inches of concrete above, below and on both sides of the conduit that shall have a minimum compressive strength of 3000 psi and a maximum aggregate size of 1-inch (Fill Class concrete). The concrete encasement may be backfilled no sooner than 24 hours after placement. “

#### **“NON-METALLIC UNDER PAVEMENT CONDUIT INSTALLATION**

Where noted on the drawings, non-metallic under pavement conduit of schedule 80 or greater rating shall be provided to facilitate conduit crossing of the existing highway and ramps without disruption to the existing highway and ramp pavement surface. The non-metallic under pavement conduit shall be hydraulically jacked or directional bored below the highway and ramp at a depth of not less than (36 inches). Under pavement conduit shall extend for a distance of (10 feet) beyond the highway or ramp edge at each side.”

Amend the sixth paragraph which begins with “Where PVC conduit runs are...” by changing “3 inch minimum bedding” to “**6 inch minimum bedding**”.

#### **626.034 Concrete Foundations**

Revise this section by removing the third paragraph which begins with “In the absence of Design Requirements...” in its entirety and replace with the following:

**“In the absence of design requirements being provided on the plans, the Contractor shall prepare and submit the foundation design(s) to the Department for review. The Contractor may propose an alternate shallow spread footing or drilled shaft configuration/design than that set forth on the drawings. Design shall be in accordance with AASHTO LRFD Specifications for Structural Supports for Highway Sign, Luminaires and Traffic Signals, current edition; AASHTO LRFD Bridge Design Specifications, current edition; and FHWA-NHI-10-016 Drilled Shafts, Construction Procedures and Design Methods, current edition. Where conflicting requirements occur, the more stringent requirements shall govern. In addition to other design requirements, foundation design shall account for Torsion for which a minimum Factor of Safety equal to 1.2 shall be achieved. In evaluating axial capacity and torsional resistance in cohesionless soils, load transfer coefficient or side resistance coefficient (beta,  $\beta$ ) will be used in accordance with Subsection 13.3.5.1 of FHWA-NHI-10-016, with beta determined in accordance with Equations 13-13 and 13-11 for silty sands to sandy silts (with varying amounts of gravel). The design criteria for the resistance of drilled shaft and spread footing foundations against overturning, sliding and bearing capacity failure shall meet the requirements of Section 4 of AASHTO LRFD Bridge Design Specifications, current edition. The structural design of foundations shall meet the requirements of AASHTO LRFD Bridge Design Specifications, current edition. The Contractor shall submit to the Department for review, three (3) copies of detailed plans and calculations of the proposed design. Design shall be prepared and sealed by a Professional Engineer licensed in the State of Maine. Construction of foundation(s) shall not commence until the Department has reviewed the foundation design.”**

On Page 6-85, add the following paragraph before the paragraph beginning with “Drilled shafts shall not be...”.

**“ No foundation design will be required for 18- and 24-inch diameter foundations for structures less than 30-feet tall and with no projecting arms. A foundation design prepared by a Professional Engineer licensed in accordance with the laws of the State of Maine will be required for all other foundations Precast foundations will be permitted for 18 and 24-inch diameter foundations for structures less than 30-feet tall and with no projecting arms. Where precast foundations are permitted flowable concrete fill shall be used as backfill in the annular space, and placed from the bottom up. Construction of precast foundations shall conform to the Standard Details and all requirements of Section 712.061 except that the concrete shall have a minimum permeability of 17 kOhm-cm and the use of calcium nitrite will not be required. “**

On Page 6-86, Revise the paragraph beginning with “Concrete for drilled shafts...” so that a portion of it reads as follows:

**“...The Contractor shall provide temporary dewatering of excavations for foundations such that concrete is placed in the dry. Concrete for drilled shafts shall be placed in accordance with Section 502.10 as temporary casing is withdrawn to prevent debris from contaminating the foundation and to ensure concrete is cast against the surrounding soil. Concrete for drilled shafts and spread footings shall be Class LP in accordance with Section 502 - Structural Concrete. Precast foundations will not be permitted except as specified above in this Section. Backfill for spread footing foundations shall be Gravel Borrow meeting the requirements of Section 703.20 - Gravel Borrow.....”**

626.05 Basis of Payment Amend this section by removing the following paragraphs:

The one which starts with “Payment will be made for the total number of linear feet of prewired conduit...”

The one which starts with “Prewired conduit within the foundations...”

Amend this subsection by adding the following paragraph and Pay Items:

**“Payment will be made for the total number of linear feet of under pavement conduit actually furnished, installed and accepted at the contract price per linear foot. This price shall include the cost of: furnishing and installing the conduit; excavating; furnishing special backfilling materials, pull wire, fittings, grounding and bonding; test cleaning interiors of conduits and all materials, labor, equipment and incidentals necessary to complete the work.”**

<b>Pay Item</b>	<b>PayUnit</b>
<b>626.221 Non-metallic Conduit, Concrete Encased</b>	<b>Linear Foot</b>
<b>626.251 Non-Metallic Under pavement Conduit (Schedule 80 or greater rating)</b>	<b>Linear Foot</b>

Remove the following Pay Items:

626.23	Prewired Conduit Secondary Wiring	Linear Foot
626.24	Prewired Conduit Primary Wiring	Linear Foot

**SECTION 627**  
**PAVEMENT MARKINGS**

Revise this section by removing it in its entirety and replacing with the following:

**627.01 Description** This work shall consist of furnishing and placing reflectorized pavement lines and markings, removing pavement lines and markings, and furnishing and applying reflectorized paint to curbing in reasonably close conformity with the plans and as designated.

**627.02 Materials** Materials shall conform to the requirements specified in the following Sections of Division 700 - Materials.

Pavement Marking Paint	708.03
Reflectorized Plastic Pavement Marking	712.05

Temporary Bi-directional Yellow Delineators shall be Temporary Object Markers (T.O.M.) as manufactured by the Davidson Plastic Company, 18726 East Valley Highway, Kent, WA 98031 or an approved equal.

**627.04 General** All pavement lines and markings shall be applied in accordance with the latest edition of Manual on Uniform Traffic Control Devices.

Longitudinal lines placed on tangent roadway segments shall be straight and true. Longitudinal lines placed on curves shall be continuous smoothly curved lines consistent with the roadway alignment. All pavement markings placed shall meet the tolerance limits shown on the plans.

Unless otherwise shown on the plans, non-interstate lines shall be 4 inches wide and broken lines shall consist of alternate 10 foot painted line segments and 30 foot gaps. On controlled access divided highways and on the interstate system lines shall be 6 inches wide and broken lines shall consist of alternate 15 foot painted line segments and 25 foot gaps. Width tolerance shall be +/- 1/4 inch.

Temporary pavement marking lines, defined in Special Provision Section 652, Maintenance of Traffic, Temporary Centerline, will be applied as many times as necessary to properly delineate traffic lanes for the safe passage of traffic. Bi-directional delineators may be used in place of temporary lines, except where specified otherwise in Special Provision 652 Maintenance of Traffic, Temporary Centerline. Delineators will be applied at 40 foot intervals.

In overnight lane closure areas that are not to be overlaid, temporary plastic lines or raised pavement markers shall be used through the length of the taper.

Newly painted lines, markings and curb shall be protected from traffic by the use of cones, stationary vehicles or other approved methods until the paint is dry.

**627.05 Preparation of Surface** Immediately before applying the pavement marking paint to the pavement or curb, the surface shall be dry and entirely free from dirt, grease, oil, or other foreign matter.

Surface preparation for application of plastic markings shall conform to the manufacturer's recommendations.

**627.06 Application** Prior to applying paint for final pavement lines, the Contractor shall perform a test for paint thickness by furnishing and placing a piece of smooth, clean metal with an area of at least 144 in<sup>2</sup> in the path of the striping truck. The striping truck shall be passed over the piece of metal, painting the surface as it passes, without applying beads. The result of this test will be used to determine the pressure setting and speed of the truck when applying paint to obtain the specified thickness. Additional paint thickness testing may be required on the final paint markings. The wet thickness of paint without beads on final pavement lines shall be a minimum of 16 mils.

On other final pavement markings and on curb, where the paint is applied by hand painting or spraying, application shall be in two uniform covering coats, each at least 10 mils thick. Before the second coat of paint has dried, the glass beads shall be applied by a pressure system that will force the glass beads onto the undried paint as uniformly as possible.

Glass beads shall be applied to the final and temporary pavement lines, marking and curb at a sufficient rate and in sufficient quantity to assure complete and uniform coverage of hand painted surfaces and achieve proper reflectivity.

Permanent and temporary white lines and markings shall have a minimum final reflectivity value of 250 millicandelas per square meter per lux (mcd/m<sup>2</sup>/lux) and permanent and temporary yellow lines and markings shall have a minimum final reflectivity value of 150 millicandelas per square meter per lux (mcd/m<sup>2</sup>/lux), as measured by the Department. Measurements taken to determine reflectivity shall be done within 4 weeks after final placement.

If the final reflectivity values are less than the described minimums, the Contractor shall repaint those areas not meeting required reflectivity at no cost to the Department. If the final reflectivity values are less than the described minimums after the second attempt, the Contractor will submit in writing a plan of action to meet the reflectivity minimums prior to continuing any work. Once the plan has been reviewed and approved by the Department, the Contractor shall re apply at no cost to the Department.

Temporary painted lines and markings shall be applied as specified for permanent painted lines, except that the thickness shall be a minimum of 16 mils.

Temporary pliant polymer marking material shall be used for temporary markings on the final pavement and on pavements not to be resurfaced when such pavement markings do not conform to the final pavement markings pattern.

The plastic final pavement lines and markings shall be applied in accordance with the manufacturer's recommendations by the inlay method of application.

**627.07 Establishment Period** Inlaid plastic pavement lines and marking material furnished and installed under this contract for final pavement markings shall still be subject to a six-month period of establishment.

The period of establishment shall commence as soon as the plastic pavement lines and markings are complete and in place and shall continue for six months. At the end of the establishment period, a minimum of 95% of the plastic pavement lines and markings shall still be in place to be acceptable.

If less than 95% of the plastic pavement lines and markings are in place after six months, the Contractor shall replace all unsatisfactory plastic pavement lines and markings on the project without additional payment. Plastic pavement lines and markings designated for replacement shall be installed according to these specifications, unless otherwise directed. Plastic pavement lines and markings replaced at the end of the six month establishment period will not be subject to a further establishment period.

**627.08 Removing Lines and Markings** When it is necessary to remove pavement lines and markings, it shall be done by high pressure water, grinding or other approved acceptable means. The method chosen must be capable of completely eradicating the existing line or marking without excessive damage to the pavement. Burning and the use of solvents to remove temporary markings from final pavement or from existing pavement not to be resurfaced will not be permitted.

**627.09 Method of Measurement** The quantity of pavement marking lines identified in the contract as a plan quantity pay item, the measurement of payment will be the number of feet shown in the Schedule of Items. This quantity will be considered final and no adjustments will be made except when changes resulting in increases or decreases are made by the Resident.

The accepted quantity of temporary or permanent pavement marking lines when identified in the contract as a linear foot item shall be measured and paid for at the contract unit price per linear foot for the total amount applied and accepted.

Double yellow centerline, broken or solid, will be considered one line for measurement purposes. The measurement of broken lines will include the gaps when painted and will not include the gaps when plastic. Double Yellow Centerline, broken or solid shall not be paid through intersections or side roads and will be paid for the actual length of painted line.

Broken white lines will include the gaps when painted and will not include the gaps when plastic inlaid pavement lines are applied. Yellow or white solid edge lines and will not be paid through intersections or side roads and will be measured by the actual length of painted line.

Temporary pavement marking lines shall not be paid through intersections or side roads and will be measured per linear foot of actual length of painted and accepted.

Reflectorized curb will be measured or computed by the square foot of curb surface actually painted and reflectorized.

The accepted quantity of removing existing pavement markings will be measured by the square foot.

Temporary Bi-directional Yellow Delineators will be measured by each unit, complete in place, maintained, and accepted.

**627.10 Basis of Payment** The accepted quantity of pavement marking lines identified in the contract as a plan quantity pay item will be paid for at the contract unit price for plan quantity. No adjustment will be made to the quantity for payment, except as described 627.09 Method of Measurement

The quantity of permanent or temporary pavement marking lines identified in the contract paid by the linear foot will be measured for payment as described under section 627.09 Method of Measurement.

All other permanent pavement markings will be paid for at the contract unit price per square foot in accordance with 627.09 Method of Measurement.

If allowed by Special Provision, the Contractor may utilize Temporary Bi-Directional Yellow and White (as required) Delineators. When utilized, payment will be made as temporary pavement marking lines, measured and paid at the contract unit price per linear foot. Such payment will include as many applications as required and removal.

Payment for final plastic pavement lines and markings will be made in two parts. The first payment of 75% will be made when plastic pavement lines and markings are placed. The payment of the remaining 25% will be made at the end of the establishment period for all plastic line and pavement markings accepted.

The accepted quantity of any pavement marking lines will be paid for at the contract unit price and will include as many applications as required and removal when required.

The accepted quantity of Temporary Bi-directional Yellow Delineators will be paid for at the contract unit price.

Payment will be made under:

<u>Pay Item</u>	<u>Pay Unit</u>
627.18 12 inch Solid White Pavement Marking Line	Linear Foot
627.711 White or Yellow Pavement Marking Line - Plan Quantity	Linear Foot
627.733 4" White or Yellow Painted Pavement Marking Line	Linear Foot
627.744 6" White or Yellow Painted Pavement Marking Line	Linear Foot
627.75 White or Yellow Pavement & Curb Marking	Square Foot
627.77 Removing Existing Pavement Marking	Square Foot
627.78 Temporary 4" Painted Pavement Marking Line, White or Yellow	Linear Foot
627.781 Temporary 6" Painted Pavement Marking Line, White or Yellow	Linear Foot
627.407 Reflectorized Plastic, White or Yellow Pavement Marking	Square Foot
627.4071 Reflectorized Plastic, White or Yellow Pavement Marking Line - Plan Quantity	Linear Foot
627.811 Temporary Bi-directional Yellow Delineators	Each

### SECTION 639 ENGINEERING FACILITIES

Revise this section by removing this section in its entirety and replace with the following:

**639.01 Description** This work shall consist of providing, erecting, lighting, equipping and maintaining buildings to be solely used by the Resident and other assigned Department representatives as a field office. Upon completion of the work, the buildings and equipment shall remain the property of the Contractor.

**639.02 Materials** Materials for buildings shall be of good quality customarily used in standard frame house or office trailer construction.

**639.03 General** The building of the type called for shall be provided before the start of work, and shall remain until work is completed and accepted, unless earlier removal is authorized. The location shall be approved by the Resident and should be adjacent or virtually adjacent to the Project.

A fire extinguisher shall be provided in each building or office trailer for electrical and chemical fires and effective on all solvents used in the building.

Walls, roof, floor, windows, and doors shall be tightly constructed to the required area.

Furnishings shall be supplied as called for. Doors shall be equipped with locks and all keys shall be in the possession of the Resident. Windows shall be equipped with latches so they may be locked on the inside. Window screens and screen doors shall be supplied when necessary. Adequate desk and desk space shall be provided. If a portable table is supplied, it should be adjustable to accommodate the various heights of employees. A 5-way adjustable office chair shall be provided in the quantities listed.

**639.04 Field Offices** Field Offices are designated Type A, Type B, or Type C. Buildings, including trailers, may be provided if they substantially equal or exceed the following requirements. Air conditioning, appropriate to the building size, shall be provided in all field offices.

The walls, roof, and floor of the building shall be completely insulated with a minimum insulation value of R-15. Office trailers shall be either new or in very good used condition. The interior walls shall be covered with suitable wall paneling. The entire office trailer shall be for the exclusive use of the Resident. The office trailer shall be winterized and completely enclosed at the bottom, if the trailer will be used in cold weather.

Other types of buildings and facilities may be furnished of equal or better quality.

A public work area will be provided in the field office that shall be designed and constructed so that individuals with disabilities can approach, enter, and exit this area.

At least one accessible route to the field office shall be provided from accessible parking. The accessible route shall comply with the Americans with Disabilities Act Accessibility Guidelines (ADAAG) and this specification.

**The minimum clear width of an accessible route shall be 36 inches except at doors. The least possible slope shall be used for an accessible route. An accessible route with a running slope greater than 1:20 shall be considered a ramp. Maximum ramp slope is 1:12. The maximum rise for any run of a ramp shall be 30 inches and the minimum clear width shall be 36 inches. Nowhere shall the cross slope of an accessible route exceed 1:50. Changes in level up to ¼ inch may be vertical and without edge treatment. Changes in level between ¼ inch and ½ inch shall be beveled with a slope no greater than 1:2. Ramp floor surfaces shall be stable, firm, and slip-resistant.**

**Ground floor surfaces along accessible routes and in accessible rooms and spaces including floors, walks, ramps, stairs, and curb ramps, shall be stable, firm, and slip-resistant.**

**The main door to the public work area shall have a minimum clear opening of 32 inches with the door opened 90 degrees, measured between the face of door and the opposite stop. Minimum maneuvering clearances at doors shall be provided. The floor or ground area within the required clearances shall be level and clear.**

**The handle and other operating devices on accessible doors shall have a shape that is easy to grasp with one hand and does not require tight grasping. Lever-operated mechanisms push type mechanisms, and U-shaped handles are acceptable designs. Hardware required for accessible door passage shall be mounted no higher than 48 inches above finished floor.**

**A minimum of 3 parking spaces will be supplied for Class B & C Field Offices and 6 for Class A. One wheelchair accessible parking space shall be located on the shortest accessible route of travel from adjacent parking to an accessible entrance.**

**Level landings shall be provided at bottom and top of each run. The landing shall be at least as wide as the ramp run leading to it with a minimum length of 60 inches.**

**If a ramp run has a rise greater than 6 inches or a horizontal projection greater than 72 inches, then it shall have handrails on both sides. Handrails shall have the following features:**

- 1) Handrails shall be provided along both sides of ramp segments. The inside handrail on switchback ramps shall always be continuous.**
- 2) If handrails are not continuous, they shall extend at least 12 inches beyond the top and bottom of the ramp segment and shall be parallel with the floor or ground surface.**
- 3) The clear space between the handrail and the wall shall be 1½ inch.**
- 4) Gripping surfaces shall be continuous.**
- 5) Top of handrail gripping surfaces shall be mounted between 34 and 38 inches above ramp surfaces.**

- 6) Ends of handrails shall be either rounded or returned smoothly to floor, wall, or post.
- 7) Handrails shall not rotate within their fittings.
- 8) The diameter or width of the gripping surfaces of a handrail shall be 1¼ to 1½ inch, or the shape shall provide an equivalent gripping surface.

Firm and sturdy steps shall also be provided with 7 inch maximum riser and 11 inch minimum depth, and at least one handrail extending from the top of the steps to a minimum 12 inches beyond the bottom of the steps.

The Contractor will make reasonable effort(s) to provide wheelchair accessible toilet facilities when "portable" facilities are provided.

The Contractor shall provide wheelchair accessible toilet facilities when flush type facilities, that is, those with running water, are provided; and the Contractor shall provide wheelchair accessible portable facilities, if used, when the contract duration exceeds two continuous construction seasons.

In addition to the facilities previously specified in this subsection, each field office shall meet the following minimum requirements:

<u>Description</u>	<u>Quantity</u>		
	<u>Type A</u>	<u>Type B</u>	<u>Type C</u>
Floor Area (Outside Dimension) - ft <sup>2</sup>	312	220	125
Inside Wall Height – feet	7	7	7
Window Area - ft <sup>2</sup>	55	35	35
Drafting Table Surface Area - ft <sup>2</sup>	15	15	15
Drafting Stools - each	2	1	1
Office Desks - each	2	1	1
Ergonomic Swivel Chairs -ea (5-way adjustable)	3	2	2
Folding Chairs - each	3	2	2
Lighting Units - each	4	2	2
Electric Wall Outlets - each	6	4	3
Power Strip Surge Protectors - each	3	2	1
Wall Closets - each	1	1	1
Plan Rack for minimum of 6 sets of plans	1	1	0
Toilet Facility	1	1	1
Wastebaskets - each	2	2	1

All windows shall be provided with shades or blinds.

**The toilet facility shall be for the exclusive use of State personnel. If requested, the Contractor will supply a lock to ensure exclusive use.**

**The Resident will have the option to reject any furniture or supplies provided to the field office based on general condition.**

**One hundred ten volt, 60 cycle, continuous electric service shall be supplied for lighting and 15 amp duplex wall outlets. Lighting shall consist of florescent light units with rapid start bulbs or LED shop style lights located over the work areas for a minimum of 50 foot candles overall. At least one external light source will be provided.**

**Drafting surfaces shall be 40 inches above the floor and have shelves beneath. Shelves for plans and rolls shall also be furnished overhead. Drafting stools shall be approximately 28 inches high.**

**Desks shall be single or double pedestal standard office type, and shall be in addition to “built-in” type desks in the office trailer.**

**Field offices shall be furnished with one four-drawer letter size metal filing cabinet.**

**Wall closets shall be 21 inches wide, 15 inches deep, and at least 4 feet high.**

**Each office shall be furnished with a broom, dustpan, sweeping compound, trash bags, and with cleaning material for cleaning glass. If the field office is carpeted, then a vacuum cleaner will be provided. The contractor will be responsible for disposing of trash from the field office.**

**The Contractor shall provide a fully functional wireless desktop copier/scanner/printer, capable of copying field books, for the Resident’s use during the project. All maintenance and supplies, except paper, shall be the responsibility of the Contractor.**

**The Contractor shall provide bottled water and a microwave for the duration of the project. All maintenance and supplies shall be the responsibility of the Contractor. Alternate source of water, such as a water cooler, may be provided as approved by resident.**

**The Contractor shall provide a 4 cubic-foot refrigerator in the field office for the duration of the project.**

**Each office shall be furnished with a 10-person general-purpose first aid kit. The first aid kit shall be periodically inspected and refilled as necessary.**

**639.08 Heat Heat appropriate to the building size shall be supplied by the Contractor to maintain an acceptable room temperature during occupancy.**

**639.091 Broadband Connection** The contractor will supply one computer broadband connection, modem lease and router. The router shall have wireless access and be 802.11n or newer capable. The type of connection supplied will be contingent upon the availability of services (i.e. DSL or Cable Broadband). It shall be the contractor's option to provide dynamic or static IP addresses through the service. The selected service will have a minimum download connection of 5.0 Mbps and 1.0 Mbps upload. The contractor shall be responsible for the installation charges and all reinstallation charges following suspended periods. Monthly service and maintenance charges shall be billed by the Internet Service Provider (ISP) directly to the contractor.

**639.10 Method of Measurement** Field office will be measured by the unit or lump sum for each building provided, equipped and maintained satisfactorily.

**639.11 Basis of Payment** The accepted quantity of field office will be paid for at the contract unit price each or lump sum which payment shall be full compensation for furnishing until contract completion, erecting, equipping, maintaining, furnishing electricity, heating, installing and maintaining toilet facilities and if necessary removing the buildings or office trailers.

Payment for these items will be made in 3 parts; the first payment of ½ to be made after the Contractor has supplied the building or office trailer and it has been approved. The remaining payments shall be made at intervals as follows:

A second payment of ¼ shall be made when one-half of the anticipated work has been completed.

The final payment of the remaining ¼ shall be made upon completion of the work.

Payment will be made under:

	<u>Pay Item</u>	<u>Pay Unit</u>
639.18	Field Office, Type A	Each
639.19	Field Office, Type B	Each
639.20	Field Office, Type C	Each

## **SECTION 652** **MAINTENANCE OF TRAFFIC**

**652.2.4 Other Devices** Revise this Section by removing the following paragraph:  
“ STOP/SLOW paddles shall be the primary and preferred hand held signaling device. Flags shall be limited to Emergencies. The paddle shall have an octagonal shape and be at least 18 inches wide with letters at least 6 inches high and should be fabricated from semi-rigid material”

And replace with these two paragraphs

**“Flaggers shall use a STOP / SLOW hand held paddle as the primary and preferred hand signaling device. Use of flags shall be limited to emergency situations.**

**STOP / SLOW paddles shall have high intensity prismatic retro reflective sheeting Type XI, have an octagonal shape on a rigid handle and shall be at least 18 inches wide with letters at least 6 inches high and shall be constructed from light semi-rigid material. The STOP (R1-1) face shall have white letters and a white border on a red background. The SLOW (W20-8) face shall have black letters and a black border on an orange background. Paddles in existing stock meeting the current specification (Type VII, Type VIII, or Type IX) may be utilized until the end of the service life or until 12/31/18. All new paddles must meet the Type XI requirements.”**

652.3.3 Submittal of Traffic Control Plan On page 6-148, note f, in the last sentence revise the “105.2.2” to “105.2.3” so that the last sentence reads, **“For a related provision, see Section 105.2.3 – Project Specific Emergency Planning.”**

652.3.4 General Revise the eighth paragraph by removing “Earth Berm” and replace it with **“Concrete Barrier”**.

Amend this section by adding the following paragraph before the paragraph beginning with “Special Detours and temporary structures...”:

**“A temporary ramp shall be constructed with HMA at the ends of the roadway section paved or milled each day. The use of millings or RAP will not be allowed, but cold patch may be temporarily utilized until HMA plants are open for the season. The maximum ramp change in elevation shall not exceed 4” vertical. For Interstate Highways or roadways with speed limits equaling or exceeding 50 mph; temporary ramps shall be constructed at a length of eight feet per inch of transition depth. For roadways with speed limits less than 50 mph and greater than 25 mph, temporary ramps shall be constructed at a length of four feet per inch of transition depth. For roadways with speed limits 25 mph or less, temporary ramps shall be constructed at a length of two feet per inch of transition depth. Materials, placement, maintenance, and removal shall be incidental to contract items.”**

652.4 Flaggers Revise this section by removing the first paragraph, and replace it with the following”

**“The Contractor shall furnish flaggers as required by the TCP or as otherwise specified by the Resident. All flaggers must have successfully completed a flagger test approved by the Department and administered by a Department-approved Flagger-Certifier. All flaggers must carry an official certification card with them at all times while flagging.**

**For daytime conditions, flaggers shall wear a top (vest, shirt or jacket) that is orange, yellow, yellow-green, or fluorescent versions of these colors meeting ANSI 107-2004, Class 2 or Class 3, along with a hardhat with 360 ° retro-reflectivity.**

**For nighttime conditions, flaggers shall wear all Class 3 apparel, meeting ANSI 107-2004, including a Class 3 top (vest, shirt or jacket) and a Class E bottom (pants or coveralls), shall be worn along with a hardhat with 360 ° retro-reflectivity and shall be visible at a minimum distance of 1000 ft. Flagger stations must be illuminated in nighttime conditions to assure visibility and will be specifically addressed in detail in the Contractor’s TCP”.**

**652.41 TRAFFIC OFFICERS**

Revise this subsection so that the subsection number and title is

**“652.4.1 TRAFFIC OFFICERS ”**

**SECTION 656**

**TEMPORARY SOIL EROSION AND WATER POLLUTION CONTROL**

656.5.2 If No Pay Item Add the following to the end of the first paragraph:

**“Failure by the Contractor to follow Standard Specification or Special Provision - Section 656 will result in a violation letter and a reduction in payment as shown in the schedule list in 656.5.1. The Department’s Resident or any other representative of The Department reserves the right to suspend the work at any time and request a meeting to discuss violations and remedies. The Department shall not be held responsible for any delay in the work due to any suspension under this item.”**

**SECTION 660**

**ON-THE-JOB TRAINING**

660.06 Method of Measurement

Remove the first sentence in its entirety and replace with **“ The OJT item will be measured by the number of OJT hours by a trainee who has successfully completed an approved training program.”**

660.07 Basis of payment to the Contractor

Remove the last word in the first sentence so that the first sentence reads **“ The OJT shall be paid for once successfully completed at the contract unit price per hour.”**

Payment will be made under

Change the Pay Item from **“660.22”** to **“660.21”** and change the Pay Unit from **“Each”** to **“Hour”**.

**SECTION 672**

**PRECAST CONCRETE BLOCK GRAVITY WALL**

672.035 Backfill Material– Revise this section by adding the following after the second paragraph: **Backfill materials shall meet the criteria in the following table.**

<u>Base Polymer</u>	<u>Property</u>	<u>Criteria</u>	<u>Test Method</u>
Polyester (PET)	pH	3 < pH < 9	AASHTO T-289
Polyolefin (PP & HDPE)	pH	pH > 3	AASHTO T-289

672.04 Design Requirements – Revise this section by replacing items 2 and 3 in the second paragraph with the following:

2. FHWA-NHI-10-024 and FHWA-NHI-10-025, Design and Construction of Mechanically Stabilized Earth Walls and Reinforced Soil Slopes, Volumes I and II, current edition.
3. FHWA-NHI-09-087 Corrosion/Degradation of Soil Reinforcements for Mechanically Stabilized Earth Walls and Reinforced Soil Slopes, current edition.

### SECTION 673 WETCAST SMALL LANDSCAPE BLOCK WALL

673.035 Backfill Material – Revise this section by adding the following after the second paragraph:

**Backfill materials shall meet the criteria in the following table.**

<u>Base Polymer</u>	<u>Property</u>	<u>Criteria</u>	<u>Test Method</u>
Polyester (PET)	pH	3 < pH < 9	AASHTO T-289
Polyolefin (PP & HDPE)	pH	pH > 3	AASHTO T-289

673.04 Design Requirements – Revise this section by replacing items 2 and 3 in the second paragraph with the following:

2. FHWA-NHI-10-024 and FHWA-NHI-10-025, Design and Construction of Mechanically Stabilized Earth Walls and Reinforced Soil Slopes, Volumes I and II, current edition.
3. FHWA-NHI-09-087 Corrosion/Degradation of Soil Reinforcements for Mechanically Stabilized Earth Walls and Reinforced Soil Slopes, current edition

## **SECTION 674**

### **PREFABRICATED CONCRETE MODULAR GRAVITY WALL**

#### 674.02 Materials

Amend this section by adding the following after “Concrete Units:” and before the paragraph beginning with “Tolerances”.

**Concrete shall be Class P. The concrete shall contain a minimum of 5.5 gallons per cubic yard of calcium nitrite solution.**

**The minimum permeability of the concrete as indicated by Surface Resistivity shall be 17 KOhm-cm.**

**Defects Defects which may cause rejection of precast units include, but are not limited to, the following:**

**Any discontinuity (crack, rock pocket, etc.) of the concrete which could allow moisture to reach the reinforcing steel.**

**Rock pockets or honeycomb over 6 square inches in area or over 1 inch deep.**

**Edge or corner breakage exceeding 12 inches in length or 1 inch in depth.**

**Any other defect that clearly and substantially impacts the quality, durability, or maintainability of the structure, as determined by the Fabrication Engineer.**

**Repair honeycombing, ragged or irregular edges and other non-structural or cosmetic defects using a patching material from the MaineDOT Qualified Products List (QPL). The repair, including preparation of the repair area, mixing and application and curing of the patching material, shall be in accordance with the manufacturer's product data sheet. Corners that are not exposed in the final product may be ground smooth with no further repair necessary if the depth of the defect does not exceed 1/2 inch. Remove form ties and other hardware to a depth of not less than 1 inch from the face of the concrete and patch the holes using a patching material from the MaineDOT QPL.**

**Repair structural defects only with the approval of the Fabrication Engineer. Submit a nonconformance report (NCR) to the Fabrication Engineer with a proposed repair procedure. Do not perform structural repairs without an NCR that has been reviewed by the Fabrication Engineer. Structural defects include, but are not be limited to, exposed reinforcing steel or strand, cracks in bearing areas, through cracks and cracks 0.013 inch in width that extend more than 12 inches in length in any direction. Give the QAI adequate notice prior to beginning any structural repairs.**

## **SECTION 677**

### **MECHANICALLY STABILIZED EARTH RETAINING WALL**

**677.03 Design Requirements** – Revise this section by replacing items 6, 7 and 8 in the second paragraph with the following:

- 6. FHWA-NHI-10-024, Design and Construction of Mechanically Stabilized Earth Walls and Reinforced Soil Slopes, Volumes I, current edition.**
- 7. FHWA-NHI-10-025, Design and Construction of Mechanically Stabilized Earth Walls and Reinforced Soil Slopes, Volumes II, current edition.**
- 8. FHWA-NHI-09-087 Corrosion/Degradation of Soil Reinforcements for Mechanically Stabilized Earth Walls and Reinforced Soil Slopes, current edition**

On page 6 - 203 change “636.041” to “677.041”

**Amend 677.042 Precast Panel Tolerances and Surface Finish by the addition of the following:**

**Defects** Defects which may cause rejection of precast units include, but are not limited to, the following:

**Any discontinuity (crack, rock pocket, etc.) of the concrete which could allow moisture to reach the reinforcing steel.**

**Rock pockets or honeycomb over 6 square inches in area or over 1 inch deep.**

**Edge or corner breakage exceeding 12 inches in length or 1 inch in depth.**

**Any other defect that clearly and substantially impacts the quality, durability, or maintainability of the structure, as determined by the Fabrication Engineer.**

**Repair honeycombing, ragged or irregular edges and other non-structural or cosmetic defects using a patching material from the MaineDOT Qualified Products List (QPL). The repair, including preparation of the repair area, mixing and application and curing of the patching material, shall be in accordance with the manufacturer's product data sheet. Corners that are not exposed in the final product may be ground smooth with no further repair necessary if the depth of the defect does not exceed 1/2 inch. Remove form ties and other hardware to a depth of not less than 1 inch from the face of the concrete and patch the holes using a patching material from the MaineDOT QPL.**

**Repair structural defects only with the approval of the Fabrication Engineer. Submit a nonconformance report (NCR) to the Fabrication Engineer with a proposed repair procedure. Do not perform structural repairs without an NCR that has been reviewed by the Fabrication Engineer. Structural defects include, but are not be limited to, exposed reinforcing steel or strand, cracks in bearing areas, through cracks and cracks 0.013 inch in width that extend more than 12 inches in length in any direction. Give the QAI adequate notice prior to beginning any structural repairs.**

**SECTION 702**  
**BITUMINOUS MATERIAL**

702.01 Asphalt Cement - Remove this section in its entirety and replace with the following:

**Performance-Graded Asphalt Binder (PGAB) that has not been modified with polymer shall conform to the requirements of AASHTO M 320. Polymer modified binder shall meet the requirements of AASHTO M 332 (including Appendix X1), except that the percent difference in nonrecoverable creep compliance, J<sub>nr</sub>diff, shall not be enforced. Performance-Graded Asphalt Binder shall not contain re-refined engine oil bottoms (REOB).**

**The Contractor shall arrange for the Supplier to furnish the following items to the Department's Asphalt Pavement Engineer:**

**a. A Quality Control Plan that conforms to the requirements of AASHTO R 26 "Certifying Suppliers of Performance-Graded Asphalt Binders" and**

**b. A CERTIFICATE OF ANALYSIS for all asphalt materials furnished for use on the project. The Certificate shall include the actual test results of the material in storage from which the shipments are being made. Certificates shall be supplied for each lot, batch, or blend of each type and grade of material. A new certificate shall be issued at least every 30 days or upon receiving or manufacture of a new material. The original of each Certificate of Analysis shall be mailed to the Departments Asphalt Pavement Engineer.**

**The Contractor shall give the supplier sufficient notice of orders to permit testing and certification. Material not certified will not be accepted for use.**

**Deliveries of asphalt materials shall be accompanied by a Bill of Lading containing the information required under Section 108.1.3 f. The Bill of Lading shall include the applicable certificate number and shall include a printed or stamped statement such as the following: "THIS IS TO CERTIFY THAT THE ASPHALT MATERIAL REPRESENTED BY THIS LOADING INVOICE CONFORMS TO THE SPECIFICATIONS OF THE PURCHASER FOR THE MATERIAL TYPE AND GRADE STATED THEREON."**

**In the event an intermediate hauler of the asphalt material is involved, a copy of their own delivery slip shall be furnished, as well as a copy of the supplier's loading invoice. The hauler's delivery slip and the supplier's loading invoice shall be cross-referenced by use of their respective serial numbers.**

**All non-bituminous components added to the binder prior to the sampling point for binder certification shall be included on the asphalt binder Certificate of Analysis identifying their presence. All non-bituminous components added after the certification sampling point and prior to transport shall be included on the Bill of Lading. All non-bituminous components added to the binder at the HMA plant shall be identified on the mix plant documentation and accompanied by test results and certification showing the effect of the additives introduced, if any.**

702.04 Emulsified Asphalt

Revise this Section by removing the first paragraph in its entirety and replace with the following:

**Emulsified Asphalt shall conform to the requirements of AASHTO M 140. Cationic emulsified asphalt shall conform to the requirements of AASHTO M 208. Anionic emulsified asphalt Grade RS-1h shall conform to the requirements in the following table:**

Type	Rapid-Setting	
Grade	RS-1h	
Tests on Emulsions	min	max
Viscosity, Saybolt Furol at 25°C SFS	20	100
Storage Stability test, 24-h, % <sup>A</sup>	-	1.0
Demulsibility, 35 ml, 0.02 N CaCl <sub>2</sub> , %	60	-
Sieve Test, % <sup>A</sup>	-	0.10
Residue by distillation, %	55	-
Tests on Residue from Distillation Test	min	max
Penetration, 25°C 100g, 5 s	40	90
Ductility, 25°C 5 cm/min, cm	40	-
Solubility in trichloroethylene or n-propyl bromide, %	97.5	-

<sup>A</sup> This requirement is waived if successful application of material has been achieved in the field.

## SECTION 703 AGGREGATES

703.01 Fine Aggregate for Concrete Replace the second paragraph with the following:

**“All fine aggregate shall be free from injurious amounts of organic impurities. Should the fine aggregate, when subjected to the colorimetric test for organic impurities, AASHTO T 21, produce a color darker than organic plate number 3, the fine aggregate shall be rejected.”**

703.0201 Alkali Silica Reactive Aggregates. Remove this section in its entirety and replace with the following:

**All coarse and fine aggregates proposed for use in concrete shall be tested for Alkali Silica Reactivity (ASR) potential under AASHTO T 303 (ASTM C 1260), Accelerated Detection of Potentially Deleterious Expansion of Mortar Bars Due to Alkali-Silica Reaction, prior to being accepted for use. Acceptance will be based on testing performed by an accredited independent lab submitted to the Department. Aggregate submittals will be required on a 5-year cycle, unless the source or character of the aggregate in question has changed within 5 years from the last test date.**

**As per AASHTO T 303 (ASTM C 1260): Use of a particular coarse or fine aggregate will be allowed with no restrictions when the mortar bars made with this aggregate expand less than or equal to 0.10 percent at 30 days from casting. Use of a particular coarse or fine aggregate will be classified as potentially reactive when the mortar bars made with this aggregate expand greater than 0.10 percent at 30 days from casting. Use of this aggregate will only be allowed with the use of cement-pozzolan blends and/or chemical admixtures that result in mortar bar expansion of less than 0.10 percent at 30 days from casting as tested under ASTM C 1567.**

**Acceptable pozzolans and chemical admixtures that may be used when an aggregate is classified as potentially reactive include, but are not limited to the following:**

**Class F Coal Fly Ash meeting the requirements of AASHTO M 295.**

**Ground Granulated Blast Furnace Slag (Grade 100 or 120) meeting the requirements of AASHTO M 302.**

**Densified Silica Fume meeting the requirements of AASHTO M 307.**

**Lithium based admixtures**

**Metakaolin**

**Pozzolans or chemical admixtures required to offset the effects of potentially reactive aggregates will be incorporated into the concrete at no additional cost to the Department.**

703.06 Aggregate for Base and Subbase - Remove the first two paragraphs in their entirety and replace with these:

**“The following shall apply to Sections (a.) and (c.) below. The material shall have a Micro-Deval value of 25.0 or less as determined by AASHTO T 327. If the Micro-Deval value exceeds 25.0, the Washington State Degradation DOT Test Method T113, Method of Test for Determination of Degradation Value (January 2009 version) shall be performed, except that the test shall be performed on the portion of the sample that passes the ½ in sieve and is retained on the No. 10 sieve. If the material has a Washington Degradation value of less than 15, the material shall be rejected.**

**The material used in Section (b.) below shall have a Micro-Deval value of 25.0 or less as determined by AASHTO T 327. If the Micro-Deval value exceeds 25.0 the material may be used if it does not exceed 25 percent loss on AASHTO T 96, Resistance to Degradation of Small-Size Coarse Aggregate by Abrasion and Impact in the Los Angeles Machine. “**

703.081 RAP for Asphalt Pavement

Remove this section in its entirety and replace with the following:

**703.081 RAP for Asphalt Pavement Recycled Asphalt Pavement (RAP) may be introduced into hot-mix asphalt pavement at percentages approved by the Department according to the MaineDOT Policies and Procedures for HMA Sampling and Testing.**

If approved by the Department, the Contractor shall provide documentation stating the source, test results for average residual asphalt content, and stockpile gradations showing RAP materials have been sized to meet the maximum aggregate size requirements of each mix designation. The Department will obtain samples for verification and approval prior to its use.

The maximum allowable percent of RAP shall be determined by the asphalt content, the percent passing the 0.075 mm sieve, the ratio between the percent passing the 0.075 mm sieve and the asphalt content, and Coarse Micro-Deval loss values as tested by the Department. The maximum percentage of RAP allowable shall be the lowest percentage as determined according to Table 4 below:

**Table 4: Maximum Percent RAP According to Test Results**

Classification	Maximum RAP Percentage Allowed	Asphalt content standard deviation	Percent passing 0.075 mm sieve standard deviation	Percent passing 0.075 mm sieve / asphalt content ratio	Residual aggregate M-D loss value
Class III	10%	≤ 1.0	N/A	≤ 4.0	≤ 18
Class II	20%	≤ 0.5	≤ 1.0	≤ 2.8	
Class I	30%	≤ 0.3	≤ 0.5	≤ 1.8	

The Department will monitor RAP asphalt content and gradation during production by testing samples from the stockpile at approximately 15,000 T intervals (in terms of mix production). The allowable variance limits (from the numerical average values used for mix designs) for this testing are determined based upon the maximum allowable RAP percentage, and are shown below in Table 5.

**Table 5: RAP Verification Limits**

Classification	Asphalt content (compared to aim)	Percent passing 0.075 mm sieve (compared to aim)
Class III	± 1.5	± 2.0
Class II	± 1.0	± 1.5
Class I	± 0.5	± 0.7

For specification purposes, RAP will be categorized as follows:

**Class III – A maximum of 10.0 percent of Class III RAP may be used in any base, intermediate base, surface, or shim mixture. A maximum of 20.0 percent of Class III RAP may be used in hand-placed mixes for item 403.209.**

**Class II – A maximum of 20.0 percent Class II RAP in any base, binder, surface, or shim course.**

**Class I – A maximum of 20.0 percent Class I RAP may be used in any base, intermediate base, surface, or shim mixture without requiring a change to the specified asphalt binder. A maximum of 30.0 percent Class I RAP may be used in in any base or intermediate base mixture provided that a PG 58-28 asphalt binder is used. A maximum of 30.0 percent Class I RAP may be used in any surface or shim mixture provided that PG 58-34 or 52-34 asphalt binder is used. Mixtures exceeding 20.0 percent Class I RAP must be evaluated and approved by the Department.**

**The Contractor may use up to two different RAP sources in any one mix design. The total RAP percentage of the mix shall not exceed the maximum allowed for the highest classification RAP source used (i.e. if a Class I & Class III used, total RAP must not exceed 30.0%). The blended RAP material must meet all the requirements of the classification for which the RAP is entered (i.e. 10% Class III with 20% Class I, blend must meet Class I criteria). The Department may take belt cuts of the blended RAP to verify the material meets these requirements. If the Contractor elects to use more than one RAP source in a design, the Contractor shall provide an acceptable point of sampling blended RAP material from the feed belt.**

**In the event that RAP source or properties change, the Contractor shall notify the Department of the change and submit new documentation stating the new source or properties a minimum of 72 hours prior to the change to allow for obtaining new samples and approval.**

703.19 Granular Borrow

Remove the gradation requirements table, and replace with the following:

Sieve Designation	Percentage by Weight Passing Square Mesh Sieves	
	Material for Underwater Backfill	Material for Embankment Construction
6 inch	100	
No. 40	0-70	0-70
No. 200	0-7.0	0-20.0

703.33 Stone Ballast - In the third paragraph, remove the words “less than” before 2.60 and add the words “or greater” after 2.60.

## **SECTION 708** **PAINTS AND PRESERVATIVES**

708.05 Timber Preservative Revise this section by removing it in its entirety and replacing with:  
**“Timber preservatives shall conform to the requirements of AASHTO M 133 and AWPA Standard U1. All preservatives shall meet the requirements of the US EPA regulations under the Federal Insecticide, Fungicide and Rodenticide Act.”**

## **SECTION 710** **FENCE AND GUARDRAIL**

710.07 Guardrail Posts Amend subsection ‘a’ by removing the words “white oak”, “cedar”, “tamarack”, “maple”, “beech”, “birch” and “red oak” from the first sentence. Also in the first sentence, place an “or” between “pine” and “eastern hemlock”. In the second sentence remove the words “well seasoned”. Remove the sentence beginning with “Wood posts and offset brackets...” and replace it with: **“Wood posts and offset brackets shall be preservative treated in accordance with the requirements of AASHTO M 133 and AWPA U1, UC4A Commodity Specification A: Sawn Products.”**

## **SECTION 712** **MISCELLANEOUS HIGHWAY MATERIAL**

### 712.061- Structural Precast Concrete Units

Under the heading, Quality Control and Quality Assurance, revise the fourth paragraph to read:

**“Acceptance is the prerogative of the Department. The Department will conduct Quality Assurance (QA) in accordance with Standard Specification Subsection 106.5. Testing deemed necessary by the Department that is in addition to the minimum testing requirements will be scheduled to minimize interference with the production schedule. The QAI will perform acceptance sampling and testing and will witness or review documentation, workmanship and testing to assure the Work is being performed in accordance with the Contract Documents.”**

Under the heading, Concrete Testing, revise the first paragraph to read as the following two paragraphs:

**“Concrete Testing Acceptance of structural precast units, for each day’s production, will be determined by the Department, based on compliance with this specification and satisfactory concrete testing results.**

At least once per week, the QAI will make 2 concrete cylinders (6 cylinders when the Contract includes permeability requirements) for use by the Department; cylinders shall be standard cured in accordance with AASHTO T23 (ASTM C31). The QAI will perform entrained air content and slump flow testing, determine water-cement ratio and determine temperature of the sampled concrete at the time of cylinder casting. All testing equipment required by the QAI to perform this testing shall be in accordance with Standard Specification Section 502.041, Testing Equipment. In addition, the Contractor shall provide a slump cone meeting the requirements of AASHTO T 119. Providing and maintaining testing and curing equipment shall be considered incidental to the work and no additional payment will be made.

Quality Control test cylinders shall be made and tested in accordance with the following standards:

**AASHTO T 22 (ASTM C39) Test Method for Compressive Strength of Cylindrical Concrete Specimens**

**AASHTO T23 (ASTM C31) Practice for Making and Curing Concrete Test Specimens in Field**

**AASHTO T141 (ASTM C172) Practice for Sampling Freshly Mixed Concrete**

**AASHTO T152 (ASTM C231) Test Method for Air Content of Freshly Mixed Concrete by the Pressure Method**

**AASHTO T196 (ASTM C173) Standard Test Method for Air Content of Freshly Mixed Concrete by the Volumetric Method**

**ASTM C1064 Test Method for Temperature of Freshly mixed Portland Cement Concrete**

**ASTM C1611 Standard Test Method for Slump Flow of Self-Consolidating Concrete”**

Under the heading, Concrete Testing, delete the paragraph that begins:

“At least once per week, the Contractor shall make 2 concrete cylinders.....for use by the Department.....”

### **SECTION 713**

#### **STRUCTURAL STEEL AND RELATED MATERIAL**

Section 713.01- Structural Steel Revise this Section by removing the sentence:

“ Impact test sampling and testing procedures shall be in accordance with AASHTO T.”

And replace it with: **“Impact test sampling and testing procedures shall be in accordance with AASHTO T 243 M/T 243 and AASHTO T 244.”**

## SECTION 717 ROADSIDE IMPROVEMENT MATERIAL

### 717.02 Agricultural Ground Limestone

In the table after the third paragraph which starts with “Liquid lime...” change the Specification for Nitrogen (N) from “15.5 percent of which 1% is from ammoniac nitrogen and 14.5 /5 is from Nitrate Nitrogen” to read **“15.5 % of which 1% is from Ammoniacal Nitrogen and 14.5 % is from Nitrate Nitrogen”**

717.061 Erosion Control Blankets Revise this section by removing it in its entirety and replacing it with the following:

**“717.061 Erosion Control Blankets Shall consist of a machine produced rolled blanket of biodegradable fibers, evenly distributed over the entire area of blanket, of a consistent thickness, sewn into a biodegradable mesh on the top and bottom surface using a cotton blend thread. The blanket shall remain in place when subject to shear stress of 1.55 lb/ft<sup>2</sup>. The blanket shall remain intact until grass is established. The blanket shall be a product currently listed on the department’s Qualified Products List (QPL) of Erosion Control Products. See Section 618.10 - Seeding, Maintenance and Acceptance.”**

## SECTION 720 STRUCTURAL SUPPORTS FOR HIGHWAY SIGNS, LUMINAIRES AND TRAFFIC SIGNALS

720.10 Wood Utility Pole Amend the first sentence in this section by adding “, **Red Pine**” after “Douglas Fir”.

Replace the paragraph beginning with “Wood Utility poles...” with:

**“Wood Utility poles shall be pressure treated, after fabrication in accordance with AASHTO Specifications M 133 and AWPA U1, UC4B, Commodity Specification D: Poles.”**

720.12 Wood Sign Posts Remove the first sentence and replace with **“Wood sign posts shall be rectangular, straight and sound timber, cut from live growing native spruce, red pine, hemlock or cedar trees, free from loose knots or other structurally weakening defects of importance, such as shake or holes or heart rot.”**

Remove the paragraph beginning with “When pressure treated sign posts are called for on the plans ...” with **“When pressure treated sign posts are called for on the plans, the wood shall be Yellow Pine, Number 2 or better, or the species listed above. The pressure treated wood shall meet AASHTO M 133 and AWPA Standard U1, UC4A, Commodity Specification A: Sawn Products.”**



### Environmental Summary Sheet

WIN: 23398.00  
Town: Randolph-Chelsea  
CPD Team Leader: Colin Greenan  
ENV Field Contact: Val Derosier

Date Submitted: 2/5/2018

NEPA Complete: Not Applicable, no federal action

**Section 106**  
Not Applicable, no federal nexus  
Section 106 Resources:

**Section 4(f) and 6(f)**  
Section 4(f)  
Not Applicable, no USDOT funds  
Section 6(f)  
Not Applicable, no takes

**Maine Department of Inland Fisheries and Wildlife Essential Habitat**  
Not Applicable **Timing Window:** Not Applicable

**Section 7**  
Not Applicable, no federal nexus  
**Species of Concern:**

**Essential Fish Habitat**  
Not Applicable, no in stream work proposed

**Maine Department of Conservation/Public Lands, Submerged Land Lease**  
Not Applicable

**Maine Land Use Regulation Commission**  
Not Applicable

**Maine Department of Environmental Protection**  
Not Applicable, no in stream work proposed

*\*Applicable Standards and Permits are included with the contract*

**Army Corps of Engineers: Section 10 of the Rivers and Harbors Act and Section 404 of the Clean Water Act.**  
Not Applicable, no in stream work proposed

*\*Applicable Standards and Permits are included with the contract*

**Stormwater Review**  
Not Applicable (project is within an MS4; <1 acre of area will be disturbed)

<input checked="" type="checkbox"/> <b>Special Provisions Required</b>		
Special Provision 105-Timing of Work Restriction	N/A <input checked="" type="checkbox"/>	Applicable <input type="checkbox"/>
Special Provision 656-Minor Soil Disturbance	N/A <input checked="" type="checkbox"/>	Applicable <input type="checkbox"/>
<b>Standard Specification 656-Erosion Control Plan</b>	<b>N/A <input type="checkbox"/></b>	<b>Applicable <input checked="" type="checkbox"/></b>
Special Provision 203-Dredge Spec	N/A <input checked="" type="checkbox"/>	Applicable <input type="checkbox"/>
General Note for Hazardous Waste	N/A <input checked="" type="checkbox"/>	Applicable <input type="checkbox"/>
Special Provision 203-Special Fill-Streambed Materials	N/A <input checked="" type="checkbox"/>	Applicable <input type="checkbox"/>
Special Provision 610-Stream Channel Rock	N/A <input checked="" type="checkbox"/>	Applicable <input type="checkbox"/>
Special Provision 203-Hazardous Waste	N/A <input checked="" type="checkbox"/>	Applicable <input type="checkbox"/>
Special Provision 105.9	N/A <input checked="" type="checkbox"/>	Applicable <input type="checkbox"/>

*\*All permits and approvals based on plans/scope as of: 1/18/18*