

Updated 04/28/17

FEDERAL PROJECT

BIDDING INSTRUCTIONS

FOR ALL PROJECTS:

1. Use pen and ink to complete all paper Bids.
2. As a minimum, the following must be received prior to the time of Bid opening:

For a Paper Bid:

- a) a copy of the Notice to Contractors, b) the completed Acknowledgement of Bid Amendments form, c) the completed Schedule of Items, d) two copies of the completed and signed Contract Offer, Agreement & Award form, e) a Bid Guaranty, (if required), and f) any other certifications or Bid requirements listed in the Bid Documents as due by Bid opening.

For an Electronic Bid:

- a) a completed Bid using Expedite® software and submitted via the Bid Express™ web-based service, b) an electronic Bid Guaranty (if required) or a faxed copy of a Bid Bond (with original to be delivered within 72 hours), and c) any other Certifications or Bid requirements listed in the Bid Documents as due by Bid opening.
3. Include prices for all items in the Schedule of Items (excluding non-selected alternates).
4. Bid Guaranty acceptable forms are:
 - a) a properly completed and signed Bid Bond on the Department's prescribed form (or on a form that does not contain any significant variations from the Department's form as determined by the Department) for 5% of the Bid Amount or
 - b) an Official Bank Check, Cashier's Check, Certified Check, U.S. Postal Money Order or Negotiable Certificate of Deposit in the amount stated in the Notice to Contractors or
 - c) an electronic bid bond submitted with an electronic bid.
5. If a paper Bid is to be sent, "FedEx First Overnight" delivery is suggested as the package is delivered directly to the DOT Headquarters Building located at 16 Child Street in Augusta. Other means, such as U.S. Postal Service's Express Mail has proven not to be reliable.

IN ADDITION, FOR FEDERAL AID PROJECTS:

6. Complete the DBE Proposed Utilization form, and submit with your bid. If you are submitting your bid electronically, you must FAX the form to (207) 624-3431. This is a curable defect.

*If you need further information regarding Bid preparation, call the DOT
Contracts Section at (207) 624-3410.*

*For complete bidding requirements, refer to Section 102 of the Maine Department
of Transportation, Standard Specifications, November 2014 Edition.*

NOTICE

The Maine Department of Transportation is attempting to improve the way Bid Amendments/Addendums are handled, and allow for an electronic downloading of bid packages from our website, while continuing to maintain an optional plan holders list.

Prospective bidders, subcontractors or suppliers who wish to download a copy of the bid package and receive a courtesy notification of project specific bid amendments must fill out the on-line plan holder registration form and provide an email address to the MDOT Contracts mailbox at: MDOT.contracts@maine.gov. Each bid package will require a separate request.

Additionally, interested parties will be responsible for reviewing and retrieving the Bid Amendments from our web site, and acknowledging receipt and incorporating those Bid Amendments in their bids using the Acknowledgement of Bid Amendment Form.

The downloading of bid packages from the MDOT website is not the same as providing an electronic bid to the Department. Electronic bids must be submitted via <http://www.BIDX.com>. For information on electronic bidding contact Rebecca Snowden at rebecca.snowden@maine.gov or Diane Barnes at diane.barnes@maine.gov.

NOTICE

For security and other reasons, all Bid Packages which are mailed, shall be provided in double (one envelope inside the other) envelopes. The *Inner Envelope* shall have the following information provided on it:

Bid Enclosed - Do Not Open

PIN:

Town:

Date of Bid Opening:

Name of Contractor with mailing address and telephone number:

In Addition to the usual address information, the *Outer Envelope* should have written or typed on it:

Double Envelope: Bid Enclosed

PIN:

Town:

Date of Bid Opening:

Name of Contractor:

This should not be much of a change for those of you who use Federal Express or similar services.

Hand-carried Bids may be in one envelope as before, and should be marked with the following information:

Bid Enclosed: Do Not Open

PIN:

Town:

Name of Contractor:

October 16, 2001

STATE OF MAINE DEPARTMENT OF TRANSPORTATION
Bid Guaranty-Bid Bond Form

KNOW ALL MEN BY THESE PRESENTS THAT _____

_____, of the City/Town of _____ and State of _____

as Principal, and _____ as Surety, a

Corporation duly organized under the laws of the State of _____ and having a usual place of

Business in _____ and hereby held and firmly bound unto the Treasurer of

the State of Maine in the sum of _____ for payment which Principal and Surety bind

themselves, their heirs, executors, administrators, successors and assigns, jointly and severally.

The condition of this obligation is that the Principal has submitted to the Maine Department of

Transportation, hereafter Department, a certain bid, attached hereto and incorporated as a

part herein, to enter into a written contract for the construction of _____

_____ and if the Department shall accept said bid

and the Principal shall execute and deliver a contract in the form attached hereto (properly

completed in accordance with said bid) and shall furnish bonds for this faithful performance of

said contract, and for the payment of all persons performing labor or furnishing material in

connection therewith, and shall in all other respects perform the agreement created by the

acceptance of said bid, then this obligation shall be null and void; otherwise it shall remain in full

force, and effect.

Signed and sealed this _____ day of _____ 20_____

WITNESS:

WITNESS

PRINCIPAL:

By _____

By: _____

By: _____

SURETY:

By _____

By: _____

Name of Local Agency: _____

NOTICE

Bidders:

Please use the attached “Request for Information” form when submitting questions concerning specific Contracts that have been advertised for Bid, include additional numbered pages as required. RFI’s may be faxed to 207-624-3431, submitted electronically through the Departments web page of advertised projects by selecting the RFI tab on the project details page or via e-mail to RFI-Contracts.MDOT@maine.gov.

These are the only allowable mechanisms for answering Project specific questions. Maine DOT will not be bound to any answers to Project specific questions received during the Bidding phase through other processes.

When submitting RFIs by Email please follow the same guidelines as stated on the “Request for Information” form and include the word “RFI” along with the Project name and Identification number in the subject line.

NOTICE

Disadvantaged Business Enterprise Proposed Utilization

The Apparent Low Bidder shall submit the Disadvantaged Business Enterprise Proposed Utilization form with their bid. This is a curable bid defect.

The Contractor's Disadvantaged Business Enterprise Proposed Utilization Plan form contains additional information that is required by USDOT.

The Contractor's Disadvantaged Business Enterprise Proposed Utilization Plan form should be used.

A copy of the new Contractor's Disadvantaged Business Enterprise Proposed Utilization Plan and instructions for completing it are attached.

Note: Questions about DBE firms, or to obtain a printed copy of the DBE Directory, contact The Office of Civil Rights at (207) 624-3066.

MDOT's DBE Directory of Certified firms can also be obtained at <http://www.maine.gov/mdot/civilrights/dbe.htm>

INSTRUCTIONS FOR PREPARING THE MaineDOT CONTRACTOR'S DBE/SUBCONTRACTOR UTILIZATION FORM

The Contractor Shall Extend equal opportunity to MaineDOT certified DBE firms (as listed in MaineDOT's DBE Directory of Certified Businesses) in the selection and utilization of Subcontractors and Suppliers.

SPECIFIC INSTRUCTIONS FOR COMPLETING THE FORM:

Insert Contractor name, the name of the person(s) preparing the form, and that person(s) telephone, fax number and e-mail address.

Calculate and provide percentage of your bid that will be allocated to DBE firms, Federal Project Identification Number, and location of the Project work.

In the columns, name each subcontractor, DBE and non-DBE firm to be used, provide the Unit/Item cost of the work/product to be provided by the subcontractor, give a brief description and the dollar value of the work.

Revised 1/12

FHWA DBE GOAL NOTICE FFY 2016-18
Maine Department of Transportation
Disadvantaged Business Enterprise Program

Notice is hereby given that in accordance with US DOT regulation 49 CFR Part 26, the Maine Department of Transportation has established a DBE Program for disadvantaged business participation in the federal-aid highway and bridge construction program; MaineDOT contracts covered by the program include consulting, construction, supplies, manufacturing, and service contracts.

For FFY 2016-18 (October 1, 2015 through September 30, 2018) MaineDOT has established an annual DBE participation goal of **2.0%** to be achieved through race/gender neutral means. This goal has been approved by the Federal Highway Administration and remains in effect through September 30, 2018. Maine DOT must meet this goal each federal fiscal year. If the goal is not met, MaineDOT must provide a justification for not meeting the goal and provide a plan to ensure the goal is met, which may include contract goals on certain projects that contractors will be required to meet.

MaineDOT asks all contractors, consultants and subcontractors to seek certified DBE firms for projects and to work to meet the determined 2.0% goal without the need to impose contract goals. DBE firms are listed on the MaineDOT website at:

<http://www.maine.gov/mdot/civilrights/dbe/>

Interested parties may view MaineDOT's DBE goal setting methodology also posted on this website. If you have questions regarding this goal or the DBE program you may contact Sherry Tompkins at the Maine Department of Transportation, Civil Rights Office by telephone at (207) 624-3066 or by e-mail at: sherry.tompkins@maine.gov

**MaineDOT CONTRACTOR'S DBE/SUBCONTRACTOR
PROPOSED UTILIZATION FORM**

All Bidders must furnish this form with their bid on Bid Opening day

Contractor: _____ **Telephone:** _____ **Ext** _____

Contact Person: _____ **Fax:** _____

E-mail: _____

BID DATE: _____

FEDERAL PROJECT PIN # _____ **PROJECT LOCATION:** _____

TOTAL ANTICIPATED DBE ____ % PARTICIPATION FOR THIS CONTRACT

W B E	D B E	Non DBE	Firm Name	Item Number & Description of Work	Quantity	Cost Per Unit/Item	Anticipated \$ Value
Subcontractor Total >							
DBE Total >							

**NOTE: THIS INFORMATION IS USED TO TRACK AND REPORT ANTICIPATED DBE PARTICIPATION IN ALL
FEDERALLY FUNDED MAINE DOT CONTRACTS. THE ANTICIPATED DBE AMOUNT IS VOLUNTARY AND WILL
NOT BECOME A PART OF THE CONTRACTUAL TERMS.**

Equal Opportunity Use:

Form received: ___/___/___ Verified by: _____

FHWA FTA FAA

**For a complete list of certified firms and company designation (WBE/DBE) go to
<http://www.maine.gov/mdot>**

Rev. 05/13

Maine Department of Transportation Civil Rights Office

Directory of Certified Disadvantaged Business Enterprises

Listing can be found at:

<http://www.maine.gov/mdot/civilrights/dbe.htm>

For additional information and guidance contact:

Civil Rights Office at (207) 624-3066

It is the responsibility of the Contractor to access the DBE Directory at this site in order to have the most current listing.

Vendor Registration

Prospective Bidders must register as a vendor with the Department of Administrative & Financial Services if the vendor is awarded a contract. Vendors will not be able to receive payment without first being registered. Vendors/Contractors will find information and register through the following link –

<http://www.maine.gov/purchases/venbid/index.shtml>

**STATE OF MAINE DEPARTMENT OF TRANSPORTATION
NOTICE TO CONTRACTORS**

Sealed Bids addressed to the Maine Department of Transportation, Augusta, Maine 04333 and endorsed on the wrapper “Bids for **Pavement Milling and Ultra-Thin Bonded Wearing Course in the Towns of Littleton and Monticello**” will be received from contractors at the Reception Desk, MaineDOT Building, Capitol Street, Augusta, Maine, until 11:00 o’clock A.M. (prevailing time) on **March 28, 2018** and at that time and place publicly opened and read. Bids will be accepted from all bidders. The lowest responsive bidder must have completed, or successfully complete, a **Highway Construction, Paving**, or project specific prequalification to be considered for the award of this contract. **We now accept electronic bids for those bid packages posted on the bidx.com website. Electronic bids do not have to be accompanied by paper bids. Please note: the Department will accept a facsimile of the bid bond; however, the original bid bond must then be received at the MDOT Contract Section within 72 hours of the bid opening.** Until further notice, dual bids (one paper, one electronic) will be accepted, with the paper copy taking precedence.

Description: Maine Federal Aid Project No. 2330200, WIN 23302.00.

Location: In Aroostook County, project is on US Route 1 beginning 0.38 of a mile north of Little Road in Littleton and extending northerly 10.21 miles, ending in Monticello.

Outline of Work: Pavement Milling, Ultra-Thin Bonded Wearing Course, and other incidental work.

For general information regarding Bidding and Contracting procedures, contact George Macdougall at (207) 624-3410. Our webpage at <http://www.maine.gov/mdot/contractors/> contains a copy of the Schedule of Items, Plan Holders List, written portions of bid amendments, drawings, bid results and an electronic form for RFI submittal. For Project-specific information fax all questions to **Scott Bickford** at (207) 624-3431, use electronic RFI form or email questions to RFI-Contracts.MDOT@maine.gov, project name and identification number should be in the subject line. Questions received after 12:00 noon of Monday (or if that Monday is a state holiday, Friday) prior to bid date will not be answered. Bidders shall not contact any other Departmental staff for clarification of Contract provisions, and the Department will not be responsible for any interpretations so obtained. TTY users call Maine Relay 711.

Specifications and bid forms may be seen at the MaineDOT Building in Augusta, Maine and at the Department of Transportation’s Regional Office in **Presque Isle**. They may be purchased from the Department between the hours of 8:00 a.m. to 4:30 p.m. by cash, credit card (Visa/Mastercard) or check payable to Treasurer, State of Maine sent to Maine Department of Transportation, **Attn.: Mailroom**, 16 State House Station, Augusta, Maine 04333-0016. They also may be purchased by telephone at (207) 624-3536 between the hours of 8:00 a.m. to 4:30 p.m. Bid Book \$10 (\$13 by mail), payment in advance, all non-refundable.

Each Bid must be made upon blank forms provided by the Department and must be accompanied by a bid bond at 5% of the bid amount or an official bank check, cashier’s check, certified check, certificate of deposit, or United States postal money order in the amount of **\$60,000.00** payable to Treasurer, State of Maine as a Bid guarantee. A Contract Performance Surety Bond and a Contract Payment Surety Bond, each in the amount of 100 percent of the Contract price, will be required of the successful Bidder.

This Contract is subject to all applicable Federal Laws. This contract is subject to compliance with the Disadvantaged Business Enterprise program requirements as set forth by the Maine Department of Transportation.

All work shall be governed by “State of Maine, Department of Transportation, Standard Specifications, November 2014 Edition,” price \$10 [\$15 by mail], and “Standard Details, November 2014 Edition,” price \$10 [\$15 by mail]. They also may be purchased by telephone at (207) 624-3536 between the hours of 8:00 a.m. to 4:30 p.m. Standard Detail updates can be found at <http://www.maine.gov/mdot/contractors/publications/>.

The right is hereby reserved to the MaineDOT to reject any or all bids.

Augusta, Maine
March 7, 2018

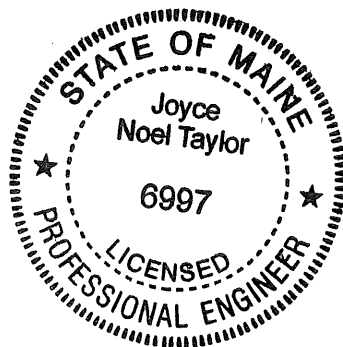

A handwritten signature in black ink that reads "Joyce Noel Taylor".

JOYCE NOEL TAYLOR P. E.
CHIEF ENGINEER

NOTICE

All bids for Federal Projects **shall** be accompanied by the DBE Proposed Utilization form. If you are submitting an electronic bid, the DBE Utilization Form may be faxed to 207-624-3431. Failure to submit the form with the bid will be considered a curable defect.

**SPECIAL PROVISION 102.7.3
ACKNOWLEDGMENT OF BID AMENDMENTS**

With this form, the Bidder acknowledges its responsibility to check for all Amendments to the Bid Package. For each Project under Advertisement, Amendments are located at <http://www.maine.gov/mdot/contractors/> . It is the responsibility of the Bidder to determine if there are Amendments to the Project, to download them, to incorporate them into their Bid Package, and to reference the Amendment number and the date on the form below. The Maine DOT will not post Bid Amendments any later than noon the day before Bid opening without individually notifying all the planholders.

Amendment Number	Date

The Contractor, for itself, its successors and assigns, hereby acknowledges that it has received all of the above referenced Amendments to the Bid Package.

CONTRACTOR

Date

Signature of authorized representative

(Name and Title Printed)

Maine Department of Transportation

Proposal Schedule of Items

Proposal ID: 023302.00

Project(s): 023302.00

SECTION: 1 HIGHWAY ITEMS

Alt Set ID: Alt Mbr ID:

Contractor: _____

Proposal Line Number	Item ID Description	Approximate Quantity and Units	Unit Price		Bid Amount	
			Dollars	Cents	Dollars	Cents
0010	202.2023 REMOVING PAVEMENT SURFACE - MEDIUM CUT DRUM	84,370.000 SY	_____	 _____	_____	 _____
0020	403.211 HOT MIX ASPHALT (SHIMMING)	100.000 T	_____	 _____	_____	 _____
0030	409.15 BITUMINOUS TACK COAT - APPLIED	50.000 G	_____	 _____	_____	 _____
0040	410.151 EMULSIFIED ASPHALT SEALCOAT, APPLIED	109,560.000 SY	_____	 _____	_____	 _____
0050	410.161 COVER COAT MATERIAL, SAND	2,400.000 LB	_____	 _____	_____	 _____
0060	424.323 ASPHALT RUBBER CRACK SEALER, APPLIED	24,440.000 LB	_____	 _____	_____	 _____
0070	462.301 POLYMER MODIFIED ULTRATHIN BONDED WEARING COURSE	160,580.000 SY	_____	 _____	_____	 _____
0080	618.13 SEEDING METHOD NUMBER 1	10.000 UN	_____	 _____	_____	 _____
0090	619.12 MULCH	10.000 UN	_____	 _____	_____	 _____
0100	627.733 4" WHITE OR YELLOW PAINTED PAVEMENT MARKING LINE	171,350.000 LF	_____	 _____	_____	 _____
0110	627.75 WHITE OR YELLOW PAVEMENT & CURB MARKING	340.000 SF	_____	 _____	_____	 _____
0120	627.77 REMOVING PAVEMENT MARKINGS	21,710.000 SF	_____	 _____	_____	 _____

Maine Department of Transportation

Proposal Schedule of Items

Proposal ID: 023302.00

Project(s): 023302.00

SECTION: 1 HIGHWAY ITEMS

Alt Set ID: Alt Mbr ID:

Contractor: _____

Proposal Line Number	Item ID Description	Approximate Quantity and Units	Unit Price		Bid Amount	
			Dollars	Cents	Dollars	Cents
0130	627.78 TEMPORARY 4 INCH PAINTED PAVEMENT MARKING LINE, WHITE OR YELLOW	406,200.000 LF	_____	 _____	_____	 _____
0140	629.05 HAND LABOR, STRAIGHT TIME	10.000 HR	_____	 _____	_____	 _____
0150	631.12 ALL PURPOSE EXCAVATOR (INCLUDING OPERATOR)	20.000 HR	_____	 _____	_____	 _____
0160	631.172 TRUCK - LARGE (INCLUDING OPERATOR)	40.000 HR	_____	 _____	_____	 _____
0170	631.212 SMALL PAVEMENT GRINDER (INCLUDING OPERATOR)	10.000 HR	_____	 _____	_____	 _____
0180	639.18 FIELD OFFICE TYPE A	1.000 EA	_____	 _____	_____	 _____
0190	652.33 DRUM	30.000 EA	_____	 _____	_____	 _____
0200	652.34 CONE	100.000 EA	_____	 _____	_____	 _____
0210	652.35 CONSTRUCTION SIGNS	590.000 SF	_____	 _____	_____	 _____
0220	652.36 MAINTENANCE OF TRAFFIC CONTROL DEVICES	55.000 CD	_____	 _____	_____	 _____
0230	652.38 FLAGGER	460.000 HR	_____	 _____	_____	 _____

Maine Department of Transportation

Proposal Schedule of Items

Proposal ID: 023302.00

Project(s): 023302.00

SECTION: 1 HIGHWAY ITEMS

Alt Set ID: Alt Mbr ID:

Contractor: _____

Proposal Line Number	Item ID Description	Approximate Quantity and Units	Unit Price		Bid Amount	
			Dollars	Cents	Dollars	Cents
0240	656.75 TEMPORARY SOIL EROSION AND WATER POLLUTION CONTROL	LUMP SUM	LUMP	SUM	_____	_____
0250	659.10 MOBILIZATION	LUMP SUM	LUMP	SUM	_____	_____
		Section: 1	Total:		_____	_____
			Total Bid:		_____	_____

CONTRACT AGREEMENT, OFFER & AWARD

AGREEMENT made on the date last signed below, by and between the State of Maine, acting through and by its Department of Transportation (Department), an agency of state government with its principal administrative offices located at Child Street, Augusta, Maine, with a mailing address at 16 State House Station, Augusta, Maine 04333-0016, and _____ a corporation or other legal entity organized under the laws of the State of _____, with its principal place of business located at _____

The Department and the Contractor, in consideration of the mutual promises set forth in this Agreement (the "Contract"), hereby agree as follows:

A. The Work.

The Contractor agrees to complete all Work as specified or indicated in the Contract including Extra Work in conformity with the Contract, **WIN 23302.00 for the Pavement Milling and Ultra-Thin Bonded Wearing Course in the Towns of Littleton and Monticello, County of Aroostook, Maine.** The Work includes construction, maintenance during construction, warranty as provided in the Contract, and other incidental work.

The Contractor shall be responsible for furnishing all supervision, labor, equipment, tools supplies, permanent materials and temporary materials required to perform the Work including construction quality control including inspection, testing and documentation, all required documentation at the conclusion of the project, warranting its work and performing all other work indicated in the Contract.

The Department shall have the right to alter the nature and extent of the Work as provided in the Contract; payment to be made as provided in the same.

B. Time.

The Contractor agrees to complete all Work, except warranty work, on or before **October 6, 2018.** Further, the Department may deduct from moneys otherwise due the Contractor, not as a penalty, but as Liquidated Damages in accordance with Sections 107.7 and 107.8 of the State of Maine Department of Transportation "Standard Specifications, November 2014 Edition" and related Special Provisions.

C. Price.

The quantities given in the Schedule of Items of the Bid Package will be used as the basis for determining the original Contract amount and for determining the amounts of the required Performance Surety Bond and Payment Surety Bond, and that the amount of this offer is _____

\$_____ Performance Bond and Payment Bond each being 100% of the amount of this Contract.

D. Contract.

This Contract, which may be amended, modified, or supplemented in writing only, consists of the Contract documents as defined in the Plans, “Standard Specifications, November 2014 Edition,” “Standard Details, November 2014 Edition” as updated through advertisement, Supplemental Specifications, Special Provisions, Contract Agreement; and Contract Bonds. It is agreed and understood that this Contract will be governed by the documents listed above.

E. Certifications.

By signing below, the Contractor hereby certifies that to the best of the Contractor’s knowledge and belief:

1. All of the statements, representations, covenants, and/or certifications required or set forth in the Bid and the Bid Documents, including those in the Federal Contract Provisions Supplement, and the Contract are still complete and accurate as of the date of this Agreement.
2. The Contractor knows of no legal, contractual, or financial impediment to entering into this Contract.
3. The person signing below is legally authorized by the Contractor to sign this Contract on behalf of the Contractor and to legally bind the Contractor to the terms of the Contract.

F. Offer.

The undersigned, having carefully examined the site of work, the Plans, Standard Specifications November 2014 Edition, Standard Details November 2014 Edition as updated through advertisement, Supplemental Specifications, Special Provisions, Contract Agreement; and Contract Bonds contained herein for construction of: **WIN 23302.00 for the Pavement Milling and Ultra-Thin Bonded Wearing Course in the Towns of Littleton and Monticello, County of Aroostook**, State of Maine, on which bids will be received until the time specified in the “Notice to Contractors” do(es) hereby bid and offer to enter into this contract to supply all the materials, tools, equipment and labor to construct the whole of the Work in strict accordance with the terms and conditions of this Contract at the unit prices in the attached “Schedule of Items.”

The Offeror agrees to perform the work required at the price specified above and in accordance with the bids provided in the attached “Schedule of Items” in strict accordance with the terms of this solicitation, and to provide the appropriate insurance and bonds if this offer is accepted by the Government in writing.

As Offeror also agrees:

First: To do any extra work, not covered by the attached “Schedule of Items,” which may be ordered by the Resident, and to accept as full compensation the amount determined upon a “Force Account” basis as provided in the Standard Specifications, November 2014 Edition, and as addressed in the contract documents.

Second: That the bid bond at 5% of the bid amount or the official bank check, cashier’s check, certificate of deposit or U. S. Postal Money Order in the amount given in the “Notice to Contractors”, payable to the Treasurer of the State of Maine and accompanying this bid, shall be forfeited, as liquidated damages, if in case this bid is accepted, and the undersigned shall fail to abide by the terms and conditions of the offer and fail to furnish satisfactory insurance and Contract bonds under the conditions stipulated in the Specifications within 15 days of notice of intent to award the contract.

Third: To begin the Work as stated in Section 107.2 of the Standard Specifications November 2014 Edition and complete the Work within the time limits given in the Special Provisions of this Contract.

Fourth: The Contractor will be bound to the Disadvantaged Business Enterprise (DBE) Requirements contained in the attached Notice (Additional Instructions to Bidders) and submit a completed Contractor’s Disadvantaged Business Enterprise Utilization Plan with their bid.

Fifth: That this offer shall remain open for 30 calendar days after the date of opening of bids.

Sixth: The Bidder hereby certifies, to the best of its knowledge and belief that: the Bidder has not, either directly or indirectly, entered into any agreement, participated in any collusion, or otherwise taken any action in restraint of competitive bidding in connection with its bid, and its subsequent contract with the Department.

IN WITNESS WHEREOF, the Contractor, for itself, its successors and assigns, hereby execute two duplicate originals of this Agreement and thereby binds itself to all covenants, terms, and obligations contained in the Contract Documents.

CONTRACTOR

Date

(Signature of Legally Authorized Representative
of the Contractor)

Witness

(Name and Title Printed)

G. Award.

Your offer is hereby accepted.
documents referenced herein.

This award consummates the Contract, and the

MAINE DEPARTMENT OF TRANSPORTATION

Date

By: David Bernhardt, Commissioner

Witness

CONTRACT AGREEMENT, OFFER & AWARD

AGREEMENT made on the date last signed below, by and between the State of Maine, acting through and by its Department of Transportation (Department), an agency of state government with its principal administrative offices located at Child Street, Augusta, Maine, with a mailing address at 16 State House Station, Augusta, Maine 04333-0016, and _____ a corporation or other legal entity organized under the laws of the State of _____, with its principal place of business located at _____

The Department and the Contractor, in consideration of the mutual promises set forth in this Agreement (the "Contract"), hereby agree as follows:

A. The Work.

The Contractor agrees to complete all Work as specified or indicated in the Contract including Extra Work in conformity with the Contract, **WIN 23302.00 for the Pavement Milling and Ultra-Thin Bonded Wearing Course in the Towns of Littleton and Monticello, County of Aroostook, Maine.** The Work includes construction, maintenance during construction, warranty as provided in the Contract, and other incidental work.

The Contractor shall be responsible for furnishing all supervision, labor, equipment, tools supplies, permanent materials and temporary materials required to perform the Work including construction quality control including inspection, testing and documentation, all required documentation at the conclusion of the project, warranting its work and performing all other work indicated in the Contract.

The Department shall have the right to alter the nature and extent of the Work as provided in the Contract; payment to be made as provided in the same.

B. Time.

The Contractor agrees to complete all Work, except warranty work, on or before **October 6, 2018.** Further, the Department may deduct from moneys otherwise due the Contractor, not as a penalty, but as Liquidated Damages in accordance with Sections 107.7 and 107.8 of the State of Maine Department of Transportation "Standard Specifications, November 2014 Edition" and related Special Provisions.

C. Price.

The quantities given in the Schedule of Items of the Bid Package will be used as the basis for determining the original Contract amount and for determining the amounts of the required Performance Surety Bond and Payment Surety Bond, and that the amount of this offer is _____

\$_____ Performance Bond and Payment Bond each being 100% of the amount of this Contract.

D. Contract.

This Contract, which may be amended, modified, or supplemented in writing only, consists of the Contract documents as defined in the Plans, "Standard Specifications, November 2014 Edition," "Standard Details, November 2014 Edition" as updated through advertisement, Supplemental Specifications, Special Provisions, Contract Agreement; and Contract Bonds. It is agreed and understood that this Contract will be governed by the documents listed above.

E. Certifications.

By signing below, the Contractor hereby certifies that to the best of the Contractor's knowledge and belief:

1. All of the statements, representations, covenants, and/or certifications required or set forth in the Bid and the Bid Documents, including those in the Federal Contract Provisions Supplement, and the Contract are still complete and accurate as of the date of this Agreement.
2. The Contractor knows of no legal, contractual, or financial impediment to entering into this Contract.
3. The person signing below is legally authorized by the Contractor to sign this Contract on behalf of the Contractor and to legally bind the Contractor to the terms of the Contract.

F. Offer.

The undersigned, having carefully examined the site of work, the Plans, Standard Specifications November 2014 Edition, Standard Details November 2014 Edition as updated through advertisement, Supplemental Specifications, Special Provisions, Contract Agreement; and Contract Bonds contained herein for construction of: **WIN 23302.00 for the Pavement Milling and Ultra-Thin Bonded Wearing Course in the Towns of Littleton and Monticello, County of Aroostook**, State of Maine, on which bids will be received until the time specified in the “Notice to Contractors” do(es) hereby bid and offer to enter into this contract to supply all the materials, tools, equipment and labor to construct the whole of the Work in strict accordance with the terms and conditions of this Contract at the unit prices in the attached “Schedule of Items.”

The Offeror agrees to perform the work required at the price specified above and in accordance with the bids provided in the attached “Schedule of Items” in strict accordance with the terms of this solicitation, and to provide the appropriate insurance and bonds if this offer is accepted by the Government in writing.

As Offeror also agrees:

First: To do any extra work, not covered by the attached “Schedule of Items,” which may be ordered by the Resident, and to accept as full compensation the amount determined upon a “Force Account” basis as provided in the Standard Specifications, November 2014 Edition, and as addressed in the contract documents.

Second: That the bid bond at 5% of the bid amount or the official bank check, cashier’s check, certificate of deposit or U. S. Postal Money Order in the amount given in the “Notice to Contractors”, payable to the Treasurer of the State of Maine and accompanying this bid, shall be forfeited, as liquidated damages, if in case this bid is accepted, and the undersigned shall fail to abide by the terms and conditions of the offer and fail to furnish satisfactory insurance and Contract bonds under the conditions stipulated in the Specifications within 15 days of notice of intent to award the contract.

Third: To begin the Work as stated in Section 107.2 of the Standard Specifications November 2014 Edition and complete the Work within the time limits given in the Special Provisions of this Contract.

Fourth: The Contractor will be bound to the Disadvantaged Business Enterprise (DBE) Requirements contained in the attached Notice (Additional Instructions to Bidders) and submit a completed Contractor’s Disadvantaged Business Enterprise Utilization Plan with their bid.

Fifth: That this offer shall remain open for 30 calendar days after the date of opening of bids.

Sixth: The Bidder hereby certifies, to the best of its knowledge and belief that: the Bidder has not, either directly or indirectly, entered into any agreement, participated in any collusion, or otherwise taken any action in restraint of competitive bidding in connection with its bid, and its subsequent contract with the Department.

IN WITNESS WHEREOF, the Contractor, for itself, its successors and assigns, hereby execute two duplicate originals of this Agreement and thereby binds itself to all covenants, terms, and obligations contained in the Contract Documents.

CONTRACTOR

Date

(Signature of Legally Authorized Representative
of the Contractor)

Witness

(Name and Title Printed)

G. Award.

Your offer is hereby accepted.
documents referenced herein.

This award consummates the Contract, and the

MAINE DEPARTMENT OF TRANSPORTATION

Date

By: David Bernhardt, Commissioner

Witness

CONTRACT AGREEMENT, OFFER & AWARD

AGREEMENT made on the date last signed below, by and between the State of Maine, acting through and by its Department of Transportation (Department), an agency of state government with its principal administrative offices located at Child Street Augusta, Maine, with a mailing address at 16 State House Station, Augusta, Maine 04333-0016, and (Name of the firm bidding the job) a corporation or other legal entity organized under the laws of the State of Maine, with its principal place of business located at (address of the firm bidding the job)

The Department and the Contractor, in consideration of the mutual promises set forth in this Agreement (the "Contract"), hereby agree as follows:

A. The Work.

The Contractor agrees to complete all Work as specified or indicated in the Contract including Extra Work in conformity with the Contract, PIN No. 1224.00, for the Hot Mix Asphalt Overlay in the town/city of South Nowhere, County of Washington, Maine. The Work includes construction, maintenance during construction, warranty as provided in the Contract, and other incidental work.

The Contractor shall be responsible for furnishing all supervision, labor, equipment, tools supplies, permanent materials and temporary materials required to perform the Work including construction quality control including inspection, testing and documentation, all required documentation at the conclusion of the project, warranting its work and performing all other work indicated in the Contract.

The Department shall have the right to alter the nature and extent of the Work as provided in the Contract; payment to be made as provided in the same.

B. Time.

The Contractor agrees to complete all Work, except warranty work, on or before November 15, 2006. Further, the Department may deduct from moneys otherwise due the Contractor, not as a penalty, but as Liquidated Damages in accordance with Sections 107.7 and 107.8 of the State of Maine Department of Transportation Standard Specifications, November 2014 Edition and related Special Provisions.

C. Price.

The quantities given in the Schedule of Items of the Bid Package will be used as the basis for determining the original Contract amount and for determining the amounts of the required Performance Surety Bond and Payment Surety Bond, and that the amount of this offer is (Place bid here in alphabetical form such as One Hundred and Two dollars and 10 cents)
\$ (repeat bid here in numerical terms, such as \$102.10) Performance Bond and Payment Bond each being 100% of the amount of this Contract.

D. Contract.

This Contract, which may be amended, modified, or supplemented in writing only, consists of the Contract documents as defined in the Plans, Standard Specifications, November 2014 Edition, Standard Details November 2014 Edition, Supplemental Specifications, Special Provisions, Contract Agreement, and Contract Bonds. It is agreed and understood that this Contract will be governed by the documents listed above.

E. Certifications.

By signing below, the Contractor hereby certifies that to the best of the Contractor's knowledge and belief:

1. All of the statements, representations, covenants, and/or certifications required or set forth in the Bid and the Bid Documents, including those in Appendix A to Division 100 of the Standard Specifications November 2014 Edition (Federal Contract Provisions Supplement), and the Contract are still complete and accurate as of the date of this Agreement.
2. The Contractor knows of no legal, contractual, or financial impediment to entering into this Contract.
3. The person signing below is legally authorized by the Contractor to sign this Contract on behalf of the Contractor and to legally bind the Contractor to the terms of the Contract.

F. Offer.

The undersigned, having carefully examined the site of work, the Plans, Standard Specifications, November 2014 Edition, Standard Details November 2014 Edition, Supplemental Specifications, Special Provisions, Contract Agreement; and Contract Bonds contained herein for construction of:

PIN 1234.00 South Nowhere, Hot Mix Asphalt Overlay,

State of Maine, on which bids will be received until the time specified in the "Notice to Contractors" do(es) hereby bid and offer to enter into this contract to supply all the materials, tools, equipment and labor to construct the whole of the Work in strict accordance with the terms and conditions of this Contract at the unit prices in the attached "Schedule of Items".

The Offeror agrees to perform the work required at the price specified above and in accordance with the bids provided in the attached "Schedule of Items" in strict accordance with the terms of this solicitation, and to provide the appropriate insurance and bonds if this offer is accepted by the Government in writing.

As Offeror also agrees:

First: To do any extra work, not covered by the attached "Schedule of Items", which may be ordered by the Resident, and to accept as full compensation the amount determined upon a "Force Account" basis as provided in the Standard Specifications, November 2014 Edition, and as addressed in the contract documents.

Second: That the bid bond at 5% of the bid amount or the official bank check, cashier's check, certificate of deposit or U. S. Postal Money Order in the amount given in the "Notice to Contractors", payable to the Treasurer of the State of Maine and accompanying this bid, shall be forfeited, as liquidated damages, if in case this bid is accepted, and the undersigned shall fail to abide by the terms and conditions of the offer and fail to furnish satisfactory insurance and Contract bonds under the conditions stipulated in the Specifications within 15 days of notice of intent to award the contract.

Third: To begin the Work as stated in Section 107.2 of the Standard Specifications November 2014 Edition and complete the Work within the time limits given in the Special Provisions of this Contract.

Fourth: The Contractor will be bound to the Disadvantaged Business Enterprise (DBE) Requirements contained in the attached Notice (Additional Instructions to Bidders) and submit a completed Contractor's Disadvantaged Business Enterprise Utilization Plan with their bid.

Fifth: That this offer shall remain open for 30 calendar days after the date of opening of bids.

Sixth: The Bidder hereby certifies, to the best of its knowledge and belief that: the Bidder has not, either directly or indirectly, entered into any agreement, participated in any collusion, or otherwise taken any action in restraint of competitive bidding in connection with its bid, and its subsequent contract with the Department.

IN WITNESS WHEREOF, the Contractor, for itself, its successors and assigns, hereby execute two duplicate originals of this Agreement and thereby binds itself to all covenants, terms, and obligations contained in the Contract Documents.

_____ **CONTRACTOR**
_____ **(Sign Here)**
(Signature of Legally Authorized Representative
of the Contractor)
_____ **(Witness Sign Here)** _____ **(Print Name Here)**
Witness (Name and Title Printed)

G. Award.

Your offer is hereby accepted.
documents referenced herein.

This award consummates the Contract, and the

MAINE DEPARTMENT OF TRANSPORTATION

Date

By: David Bernhardt, Commissioner

(Witness)

STATE OF MAINE
DEPARTMENT OF TRANSPORTATION



LITTLETON - MONTICELLO
AROOSTOOK COUNTY
US ROUTE 1

FEDERAL PROJECT NO. 2330200
PROJECT LENGTH : 10.21 MILES

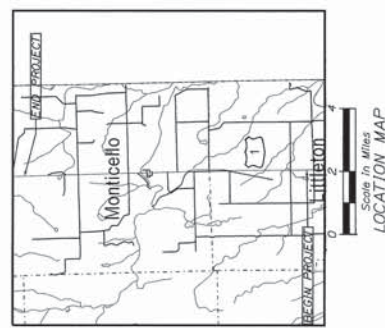
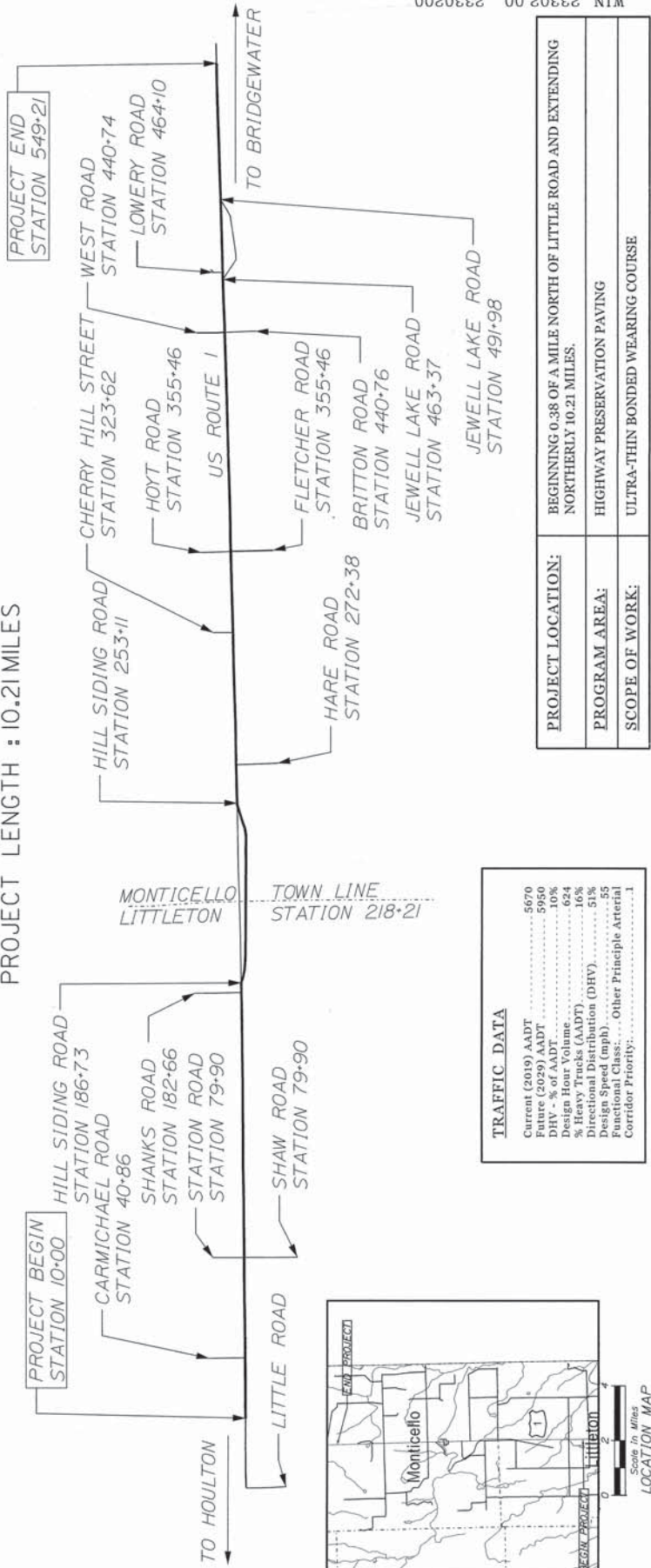

TRAFFIC DATA

Current (2019) AADT	5670
Future (2029) AADT	5950
DHV - % of AADT	10%
Design Hour Volume	624
% Heavy Trucks (AADT)	16%
Directional Distribution (DHV)	51%
Functional Class	Other Principle Arterial
Corridor Priority	1

PROJECT LOCATION:	BEGINNING 0.38 OF A MILE NORTH OF LITTLE ROAD AND EXTENDING NORTHERLY 10.21 MILES.
PROGRAM AREA:	HIGHWAY PRESERVATION PAVING
SCOPE OF WORK:	ULTRA-THIN BONDED WEARING COURSE

STATE OF MAINE PROFESSIONAL ENGINEER LICENSE NO. 1000 HELENA 1 SIGNATURE	DATE 1/22/2018	PROJECT INFORMATION PROJECT NUMBER 13550 PROJECT MANAGER HOOR SMOY PROGRAM	LITTLETON-MONTICELLO US ROUTE 1 TITLE SHEET	SHEET NUMBER 1	OF 1
DEPARTMENT OF TRANSPORTATION APPROVED DATE 3/1/18 COMMISSIONER CHIEF ENGINEER 9-2-18					

3/4" ULTRA-THIN BONDED WEARING COURSE TRUCK LANE

- NOTE:**
1. THE STATIONING & WIDTHS SHOWN IN THE CONSTRUCTION NOTES ARE APPROXIMATE.
 2. WHEN SUPERELEVATION EXCEEDS THE SLOPE OF THE LOW SIDE SHOULDER, THE LOW SIDE SHOULDER SHALL HAVE THE SAME SLOPE AS THE TRAVELWAY.
 3. VARIABLE DEPTH SHIM IS TO BE PLACED IF RUTTING EXCEEDS 1/2" AFTER MILLING. IF DELAMINATION OCCURS, OR AS DIRECTED BY THE RESIDENT.
 4. CONTRACTOR SHALL MAINTAIN EXISTING SHOULDER BREAKS ON TRAVELWAY AND TRUCK LANES.

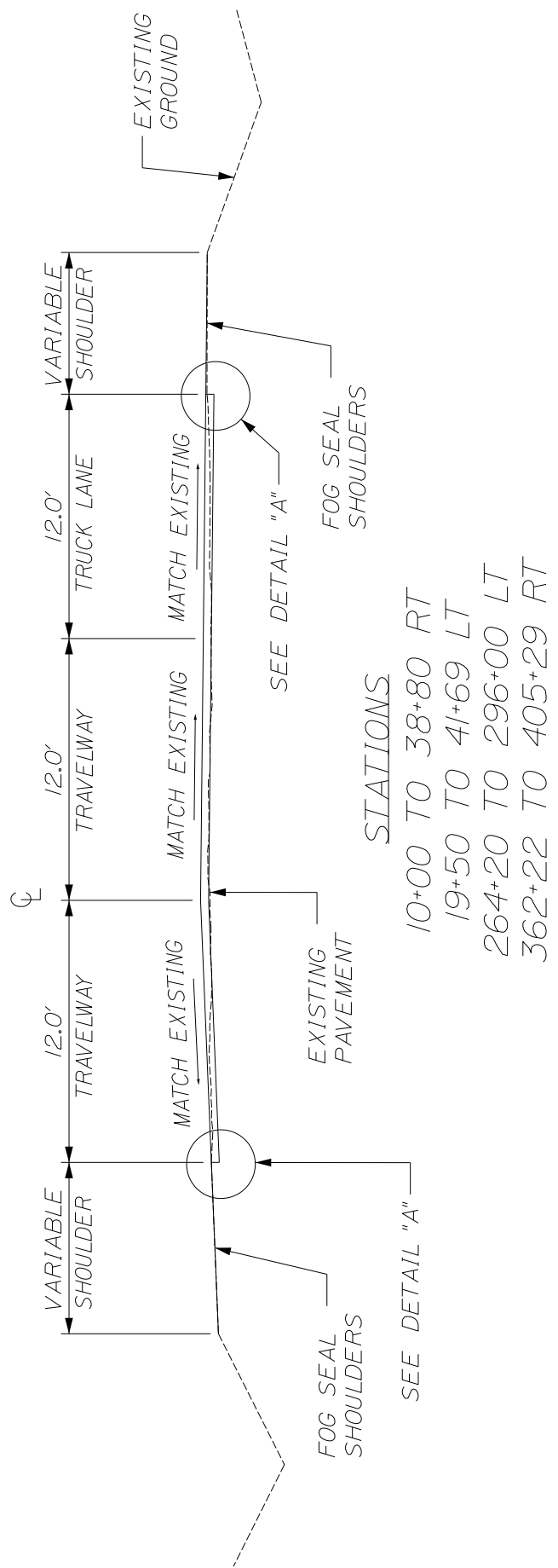
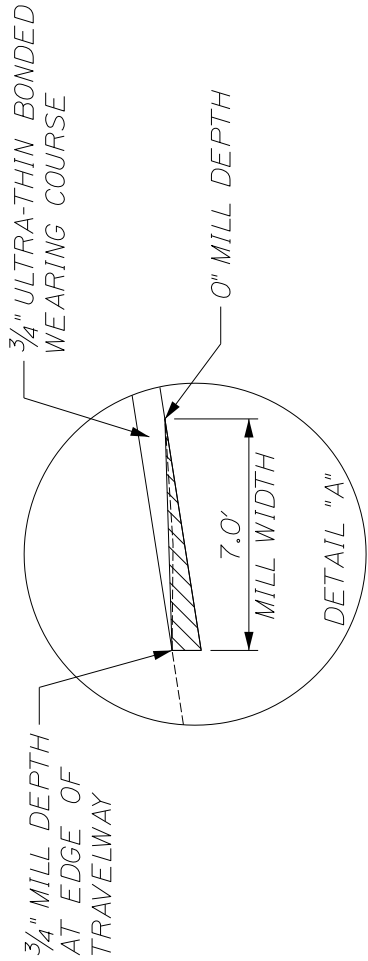

<u>Project Stationing</u>		
<u>Left</u>	<u>Station</u>	<u>Right</u>
Pole 207	115+41	
Pole 205	109+97	
Pole 203	104+30	
Pole 201-1/2	100+57	
Pole 200	96+57	Pole 200D
Pole 198	91+01	
Pole 196	85+33	
Pole 194	80+46	
Station Road	79+90	Shaw Road
Pole 192	73+76	
Pole 405	69+13	
Pole 188	63+98	
Pole 186	59+17	
Pole 184	54+38	
End Guardrail	53+31	
	52+58	End Guardrail
Pole 182	49+72	
	49+20	Begin Guardrail
Begin Guardrail	48+19	
Pole 181	47+62	
Pole 179	43+35	
Carmichael Road	40+86	
	40+72	Ingraham Road
Pole 177	38+53	
Pole 174	30+93	
Pole 172	26+51	
Pole 170	22+41	
Pole 16	15+18	
Begin project	10+00	Begin project

Project Stationing

<u>Left</u>	<u>Station</u>	<u>Right</u>
Pole 404	264+05	
Pole 402	259+28	
	257+36	Pole 4010
Hillsiding Road	253+11	
	244+42	MDOT Survey Control Sign
	240+78	Curve Sign
	226+29	Welcome to Monticello sign
	222+82	Pole 35319
	218+21	Littleton/Monticello Townline
	217+93	Gentle Road
	215+13	Pole 25
	209+53	Pole 35324
	199+53	Pole 7
	197+07	Pole 35327
	192+01	Pole 4
	187+34	Pole 2
Shanks Road	182+66	
Pole 366	177+25	
Pole 364	172+48	
Pole 362	167+06	Pole 362S
Pole 360	161+90	
Pole 358	156+66	
Pole 356	151+61	
	146+81	Pole 354S
Pole 217	142+21	
Pole 215	137+63	
Pole 213	132+08	
Pole 211	126+55	
Pole 209	121+06	

Project Stationing

<u>Left</u>	<u>Station</u>	<u>Right</u>
	353+19	Pole 32
	350+08	Pole 30
	346+59	Pole 28
	341+44	Pole 24
	338+75	Pole 23-1/2
Bridge Joint North Side	336+88	
Bridge Joint South Side	333+80	
	330+92	Pole 21
	328+06	Pole 19
	325+55	Pole 34386
Cherry Hill Road	323+62	School St
	319+72	Pole 12
	318+92	School St
	315+00	Church St
Silver St	314+75	
	313+69	Pole 7
	310+68	Pole 901/5
Pole 2	307+41	
Pole 424	302+52	
Pole 422	297+24	
Pole 34255	292+32	
Station Road	288+67	
	287+28	Pole 417X
Pole 410	282+69	
Pole 412	280+01	
Pole 405	277+40	
	274+89	Pole 34337
	272+38	Hare Road
Pole 406	268+60	

Project Stationing

<u>Left</u>	<u>Station</u>	<u>Right</u>
Pole 463	466+53	
Lovely Road	464+10	
	463+37	Jewel Lake Road
Pole 461	460+73	
Pole 459	454+62	
Pole 457	449+30	
Pole 405/455	443+92	
	440+76	Britton Road
Pole 452	437+04	
Pole 40/45	432+06	
Pole 448	426+25	
Pole 446	421+06	
Pole 444	416+26	
Pole 442	410+97	
Pole 39	402+80	
Pole 437	397+77	
	395+21	MDOT Survey Marker
Pole 433	390+11	
	388+57	Warning Petro Line sign
	384+71	Pole 431S
Pole 428	379+37	
Pole 34438	375+74	
Pole 425	371+99	
Pole 43	368+44	
Pole 41	364+93	
Pole 39	362+19	
	359+69	Pole 37
	357+04	Pole 35
Hoyt Road	355+46	Fletcher Road

<u>Left</u>	<u>Project Stationing</u>	<u>Right</u>
End Project	549+21	End Project
	546+04	Pole 492
	541+49	Pole 405/490
	535+82	Pole 488
	530+69	Pole 486
	524+92	Pole 484
	520+39	Pole 482
	515+08	Pole 405/480
	509+68	Pole 478
	505+30	Pole 476
	499+60	Pole 474
	494+03	Pole 472
	491+98	Jewel Lake Road
	487+86	Pole 470
	484+42	Pole 468-1/2
	480+16	Pole 467
	477+69	Pole 405/466
Pole 464	470+70	

Construction Notes

202.2023 Removing Pavement Surface – Medium Cut Drum

<u>Description</u>	<u>Station</u>	<u>to</u>	<u>Station</u>	<u>Width</u>	<u>Side</u>
Begin Mainline	10+00	-	10+38	24'	LEFT/RIGHT
Truck Lane	10+00	-	10+38	12'	RIGHT
Truck Lane	19+50	-	19+88	12'	RIGHT
Truck Lane	38+42	-	38+80	12'	RIGHT
Truck Lane	19+50	-	19+88	12'	LEFT
Truck Lane	41+31	-	41+69	12'	LEFT
Truck Lane	264+20	-	264+58	12'	LEFT
Truck Lane	295+62	-	296+00	12'	LEFT
Truck Lane	362+22	-	362+60	12'	RIGHT
Truck Lane	404+91	-	405+29	12'	RIGHT
End Mainline	548+83	-	549+21	24'	LEFT/RIGHT
Edge Travelway (3/4" - 0")	10+00	-	549+21	7'	LEFT/RIGHT

Note:

- Above locations are estimates only and may be changed by the Resident. Actual depth may be determined in the field by the resident.
- Mainline will be ground at a depth of ¾" the entire width of the travel way for beginning and ending transitions, and ¾" depth at the edge of travel way or as determined in the field by the Resident.
- All generated millings are to become the property of the contractor.

403.211 Hot Mix Asphalt (Shim)

This item to be used as directed by the resident to correct areas of delamination, rutting, cross pipe dips greater than ½" and this item will be used for the correction of areas with low centerline grades.

The following stations are noted to correct a "V" at centerline.

	<u>Station</u>	<u>to</u>	<u>Station</u>	<u>Width</u>
Mainline	180+00	-	182+00	24'
Mainline	250+00	-	255+00	24'

Stations are approximate and will be determined in the field by Resident.

Construction Notes

410.151 Emulsified Asphalt Sealcoat, Applied

<u>Description</u>	<u>Station</u>	<u>to</u>	<u>Station</u>	<u>Width</u>
Shoulder LT	10+00	-	549+21	Variable
Shoulder RT	10+00	-	549+21	Variable

Note:

- To be done after Ultra-Thin Bonded Wearing Course paving is complete and prior to final striping

410.161 Cover Coat Material, Sand

<u>Description</u>	<u>Station</u>	<u>to</u>	<u>Station</u>	<u>Length</u>	<u>Width</u>
Carmichael Road	40+86			150'	10'
Ingraham Road	40+72			150'	10'
Station Road	79+90			150'	10'
Shanks Road	182+66			150'	10'
Hill Siding Road	186+73			150'	10'
Hill Siding Road	253+11			150'	10'
Hare Road	272+38			150'	10'
Cherry Hill Road	323+62			150'	10'
Hoyt Road	355+46			150'	10'
Fletcher Road	355+46			150'	10'
West Road	440+74			150'	10'
Britton Road	440+76			150'	10'
Jewell Lake Road (S)	463+37			150'	10'
Lowery Road	464+10			150'	10'
Jewell Lake Road (N)	491+98			150'	10'
Turn Lane RIGHT	214+44		220+14	570'	10'
Turn Lane RIGHT	436+00		443+50	750'	12'
Turn Lane LEFT	438+50		443+50	500'	12'

Note:

- Above locations are estimates only, exact locations will be determined by the Resident.

Construction Notes

424.323 Asphalt Rubber Crack Sealer, Applied

This item to be used to seal cracks on existing mainline travel way after Milling and prior to the placement of the ¾” Ultra-Thin Bonded Wearing Course, from Sta. 10+00 to 549+21. This item will also be used for the sealing of cracks on paved shoulders prior to the application of the Emulsified Asphalt Sealcoat.

462.301 Ultra-Thin Bonded Wearing Course

<u>Station</u>	<u>to</u>	<u>Station</u>	<u>Width</u>	<u>Side</u>	<u>Comments</u>
10+00		19+50	12'	LEFT	Mainline
19+50		41+69	24'	LEFT	Mainline & Truck Lane
41+69		264+20	12'	LEFT	Mainline
264+20		296+00	24'	LEFT	Mainline & Truck Lane
296+00		549+21	12'	LEFT	Mainline
10+00		38+80	24'	RIGHT	Mainline & Truck Lane
38+80		363+22	12'	RIGHT	Mainline
362+22		405+29	24'	RIGHT	Mainline & Truck Lane
405+29		549+21	12'	RIGHT	Mainline

Item shall be placed on the travel way and truck lanes.

627.733 4” White or Yellow Painted Pavement Marking Line

- Final striping will not commence until 10 days have elapsed from the completion of surface pavement and must be completed within 20 days of the completion of surface pavement. Unless otherwise directed, failure to comply will result in a Traffic Control Violation.
- Once construction is complete, Maintenance of Traffic Control Devices (Item #652.36) will not be paid while waiting to final stripe.
- Once construction is complete, liquidated damages will not be charged while waiting to final stripe.

Construction Notes

627.77 Removing Pavement Markings

<u>Station</u>	<u>to</u>	<u>Station</u>	<u>Comments</u>
10+00		549+21	Remove Centerline pavement marking
10+00		32+30	Right Truck Lane divider
29+44		38+90	Left Truck Lane divider
272+63		292+74	Left Truck Lane divider
366+18		393+10	Right Truck Lane divider
27+40			Left Truck Lane merge arrow
31+00			Left Truck Lane merge arrow
35+15			Right Truck Lane merge arrow
270+75			Left Truck Lane merge arrow
274+15			Left Truck Lane merge arrow
393+18			Right Truck Lane merge arrow
396+29			Right Truck Lane merge arrow

The contractor shall establish centerline striping pattern prior to removal of existing centerline. Refer to General Note #14.

627.78 Temporary 4” Painted Pavement Marking Line, White or Yellow

All areas where the existing centerline striping is removed under Item 627.77 – Removing Pavement Markings will receive (1) application of temporary striping prior to placing the Ultra-Thin Bonded Wearing Course.

Centerline and edge lines will receive (2) applications of temporary paint on the Ultra-Thin Bonded Wearing Course prior to final striping. The (2) applications of temporary paint may be applied on the same day as long as the first application has completely dried prior to placing the second application.

Temporary center lines and edge lines shall be painted on all matched pavement within one week.

All temporary lines shall be painted prior to final striping.

Multilane sections, truck lanes, and milled surfaces must be striped daily on all matched pavement layers.

Construction Notes

629 & 631 Hourly Items

Primary use of the Hourly Items will be for the removal of excess material from top of curb, guardrail, and in-slopes. Cleaning of pavement following rental work will be considered incidental to the rental items, and will be done daily to the satisfaction of the Resident.

652.35 Construction Signs

“ROAD WORK NEXT 10 MILES” signs are to be used on each end of the project as part of the approach sign package.

General Notes

- 1) Where deemed necessary by the Resident, unsuitable excess material shall be removed from the edges of shoulders and placed in designated areas or disposed of. Payment will be made under the appropriate contract items.
- 2) The Contractor shall place suitable existing or other material acceptable to the Resident on all pavement edges to allow a drop off no greater than the surface pavement thickness. The material shall be graded to match existing in-slope or as directed by the Resident before surface is placed. The contractor will be paid under appropriate equipment rental items. Borrow is not authorized until all acceptable waste material has been utilized. Seed and Mulch will be paid for at the contract unit price.
- 3) All waste material not used on the project shall be disposed of in acceptable waste areas and reviewed by the Resident. Grading, seeding, and mulching of waste areas shall be considered incidental.
- 4) Any necessary cleaning of existing pavement prior to paving (or milling) shall be incidental to the related paving (or milling) items. This includes killing and removal of all vegetative matter.
- 5) When super elevation exceeds the slope of the low side shoulder, the shoulder pavement will have same slope as traveled way.
- 6) Unless otherwise noted Seeding Method No. 1 shall be utilized on all lawns and developed areas; Seeding Method No. 2 shall be utilized on all other areas.
- 7) The Contractor will be responsible for maintaining all existing mailboxes to ensure that the mail will be deliverable. Payment for this work will be made under the appropriate rental items.
- 8) Any damage to the slopes caused by the contractor's equipment, personnel, or operation shall be repaired to the satisfaction of the resident. All work, equipment, and materials required to make repairs shall be at the contractor's expense.
- 9) Plans of previously constructed projects are available on request. These projects are:
 - NH-9137(00)E; Littleton – Monticello
 - AC-IB-1923(500)X; Littleton – Monticello
- 10) Areas requiring fill on the project will come from suitable excavation from ditch and inslope or equipment rental areas.

General Notes

- 11) No separate payment for superintendent or foreman will be made for the supervision of equipment being paid for under the equipment rental items.
- 12) "Undetermined Locations" shall be determined by the Resident.
- 13) Stations referenced are approximate.
- 14) The contractor will place appropriately marked stakes at the following locations on the project: striping pattern changes, cross-slope changes, and every 500' for stationing. The contractor will paint every full station (100') on the existing roadway and will transfer the painted stationing through all intermediate lifts (not surface). Appropriately sized striping pattern changes will be painted on surface. Stationing control must be placed before work can commence. Cross-slope and striping change controls must be placed before paving can commence.

General Decision Number: ME180110 01/05/2018 ME110

Superseded General Decision Number: ME20170110

State: Maine

Construction Type: Highway

County: Aroostook County in Maine.

HIGHWAY CONSTRUCTION PROJECTS

Note: Under Executive Order (EO) 13658, an hourly minimum wage of \$10.35 for calendar year 2018 applies to all contracts subject to the Davis-Bacon Act for which the contract is awarded (and any solicitation was issued) on or after January 1, 2015. If this contract is covered by the EO, the contractor must pay all workers in any classification listed on this wage determination at least \$10.35 per hour (or the applicable wage rate listed on this wage determination, if it is higher) for all hours spent performing on the contract in calendar year 2018. The EO minimum wage rate will be adjusted annually. Please note that this EO applies to the above-mentioned types of contracts entered into by the federal government that are subject to the Davis-Bacon Act itself, but it does not apply to contracts subject only to the Davis-Bacon Related Acts, including those set forth at 29 CFR 5.1(a)(2)-(60). Additional information on contractor requirements and worker protections under the EO is available at www.dol.gov/whd/govcontracts.

Modification Number	Publication Date
0	01/05/2018

* ENGI0004-005 12/01/2017

	Rates	Fringes
POWER EQUIPMENT OPERATOR:		
Grader/Blade.....	\$ 29.80	26.66
Milling Machine.....	\$ 29.80	26.66
Paver (Asphalt, Aggregate, and Concrete).....	\$ 29.80	26.66
Roller Asphalt.....	\$ 29.80	26.66

SUME2014-029 06/23/2017

	Rates	Fringes
CARPENTER, Includes Form Work....	\$ 18.34	2.84
HIGHWAY/PARKING LOT STRIPING:		
Laborer.....	\$ 14.29	1.89
IRONWORKER, REINFORCING.....	\$ 16.27	0.00
LABORER: Asphalt, Includes Raker, Shoveler, Spreader and Distributor.....	\$ 14.32	3.17
LABORER: Common or General.....	\$ 13.23	1.22

LABORER: Wheelman.....	\$ 15.40	3.01
OPERATOR:		
Backhoe/Excavator/Trackhoe.....	\$ 17.63	2.28
OPERATOR: Bobcat/Skid		
Steer/Skid Loader.....	\$ 20.36	5.06
OPERATOR: Broom/Sweeper.....	\$ 16.52	6.38
OPERATOR: Bulldozer.....	\$ 16.58	2.89
OPERATOR: Loader.....	\$ 16.21	3.23
OPERATOR: Mechanic.....	\$ 22.30	8.71
OPERATOR: Screed.....	\$ 18.82	4.75
OPERATOR: Roller (Earth).....	\$ 15.55	5.83
TRAFFIC CONTROL: Flagger.....	\$ 9.00	0.00
TRAFFIC CONTROL:		
Laborer-Cones/ Barricades/Barrels -		
Setter/Mover/Sweeper.....	\$ 17.48	5.37
TRUCK DRIVER: Dump Truck.....	\$ 14.40	7.04
TRUCK DRIVER: TackTruck.....	\$ 18.82	8.29

WELDERS - Receive rate prescribed for craft performing operation to which welding is incidental.

=====

Note: Executive Order (EO) 13706, Establishing Paid Sick Leave for Federal Contractors applies to all contracts subject to the Davis-Bacon Act for which the contract is awarded (and any solicitation was issued) on or after January 1, 2017. If this contract is covered by the EO, the contractor must provide employees with 1 hour of paid sick leave for every 30 hours they work, up to 56 hours of paid sick leave each year. Employees must be permitted to use paid sick leave for their own illness, injury or other health-related needs, including preventive care; to assist a family member (or person who is like family to the employee) who is ill, injured, or has other health-related needs, including preventive care; or for reasons resulting from, or to assist a family member (or person who is like family to the employee) who is a victim of, domestic violence, sexual assault, or stalking. Additional information on contractor requirements and worker protections under the EO is available at www.dol.gov/whd/govcontracts.

Unlisted classifications needed for work not included within the scope of the classifications listed may be added after award only as provided in the labor standards contract clauses (29CFR 5.5 (a) (1) (ii)).

The body of each wage determination lists the classification and wage rates that have been found to be prevailing for the cited type(s) of construction in the area covered by the wage determination. The classifications are listed in alphabetical order of "identifiers" that indicate whether the particular rate is a union rate (current union negotiated rate for local), a survey rate (weighted average rate) or a union average rate (weighted union average rate).

Union Rate Identifiers

A four-letter classification abbreviation identifier enclosed in dotted lines beginning with characters other than "SU" or "UAVG" denotes that the union classification and rate were prevailing for that classification in the survey. Example: PLUM0198-005 07/01/2014. PLUM is an abbreviation identifier of the union which prevailed in the survey for this classification, which in this example would be Plumbers. 0198 indicates the local union number or district council number where applicable, i.e., Plumbers Local 0198. The next number, 005 in the example, is an internal number used in processing the wage determination. 07/01/2014 is the effective date of the most current negotiated rate, which in this example is July 1, 2014.

Union prevailing wage rates are updated to reflect all rate changes in the collective bargaining agreement (CBA) governing this classification and rate.

Survey Rate Identifiers

Classifications listed under the "SU" identifier indicate that no one rate prevailed for this classification in the survey and the published rate is derived by computing a weighted average rate based on all the rates reported in the survey for that classification. As this weighted average rate includes all rates reported in the survey, it may include both union and non-union rates. Example: SULA2012-007 5/13/2014. SU indicates the rates are survey rates based on a weighted average calculation of rates and are not majority rates. LA indicates the State of Louisiana. 2012 is the year of survey on which these classifications and rates are based. The next number, 007 in the example, is an internal number used in producing the wage determination. 5/13/2014 indicates the survey completion date for the classifications and rates under that identifier.

Survey wage rates are not updated and remain in effect until a new survey is conducted.

Union Average Rate Identifiers

Classification(s) listed under the UAVG identifier indicate that no single majority rate prevailed for those classifications; however, 100% of the data reported for the classifications was union data. EXAMPLE: UAVG-OH-0010 08/29/2014. UAVG indicates that the rate is a weighted union average rate. OH indicates the state. The next number, 0010 in the example, is an internal number used in producing the wage determination. 08/29/2014 indicates the survey completion date for the classifications and rates under that identifier.

A UAVG rate will be updated once a year, usually in January of each year, to reflect a weighted average of the current negotiated/CBA rate of the union locals from which the rate is based.

WAGE DETERMINATION APPEALS PROCESS

1.) Has there been an initial decision in the matter? This can be:

- * an existing published wage determination
- * a survey underlying a wage determination
- * a Wage and Hour Division letter setting forth a position on a wage determination matter
- * a conformance (additional classification and rate) ruling

On survey related matters, initial contact, including requests for summaries of surveys, should be with the Wage and Hour Regional Office for the area in which the survey was conducted because those Regional Offices have responsibility for the Davis-Bacon survey program. If the response from this initial contact is not satisfactory, then the process described in 2.) and 3.) should be followed.

With regard to any other matter not yet ripe for the formal process described here, initial contact should be with the Branch of Construction Wage Determinations. Write to:

Branch of Construction Wage Determinations
Wage and Hour Division
U.S. Department of Labor
200 Constitution Avenue, N.W.
Washington, DC 20210

2.) If the answer to the question in 1.) is yes, then an interested party (those affected by the action) can request review and reconsideration from the Wage and Hour Administrator (See 29 CFR Part 1.8 and 29 CFR Part 7). Write to:

Wage and Hour Administrator
U.S. Department of Labor
200 Constitution Avenue, N.W.
Washington, DC 20210

The request should be accompanied by a full statement of the interested party's position and by any information (wage payment data, project description, area practice material, etc.) that the requestor considers relevant to the issue.

3.) If the decision of the Administrator is not favorable, an interested party may appeal directly to the Administrative Review Board (formerly the Wage Appeals Board). Write to:

Administrative Review Board
U.S. Department of Labor
200 Constitution Avenue, N.W.
Washington, DC 20210

4.) All decisions by the Administrative Review Board are final.

=====
END OF GENERAL DECISION

**SPECIAL PROVISIONS
 SECTION 104
 Utilities**

UTILITY COORDINATION

The contractor has primary responsibility for coordinating their work with utilities after contract award. The contractor shall communicate directly with the utilities regarding any utility work necessary to maintain the contractor’s schedule and prevent project construction delays. The contractor shall notify the resident of any issues.

THE CONTRACTOR SHALL PLAN AND CONDUCT WORK ACCORDINGLY.

MEETING

A Preconstruction Utility Conference, as defined in Subsection 104.4.6 of the Standard Specifications, **is not** required.

GENERAL INFORMATION

These Special Provisions outline the arrangements that have been made by the Department for utility work to be undertaken in conjunction with this project. The following table identify all known utilities having facilities presently located within the limits of the specified road segment or intending to adjust facilities during this construction project.

Utilities have been notified and shall be furnished a project booklet electronically.

Utility Overview & Contact Information				
Utility	Aerial	Subsurface	Contact Person	Contact Phone
FairPoint Communications	X	X	Tom Robinson	764-3120 office
Emera Maine	X		Tom Rodgerson	941-6629 office
Spectrum_Charter	X		Patrick Hardgrove	253-2443 office
Maine Fiber Company	X		Tim LaBreck	956-6657 office
Bangor Natural Gas		X	Joshua Saucier	941-9595 office

Temporary utility adjustments **are not** anticipated as part of this project. If any unexpected utility relocations become necessary, they shall be scheduled in compliance with Section 104 of the Standard Specifications and shall be performed by the appropriate utility company in conjunction with the work by the Contractor. Should the contractor choose to have any poles temporarily relocated, all work shall be done at the Contractor’s request and expense, with no additional cost or schedule impacts to the Department.

Any adjustments are to be made by the respective utility unless otherwise specified herein.

Utility working days are Monday through Friday. Times are estimated based on a single crew for each utility. Any times and dates mentioned are **estimates only** and dependent upon favorable weather, working conditions, and freedom from emergencies. The Contractor shall have no claim against the Department if they are exceeded.

BUY AMERICA

Utility construction work performed as part this federal-aid project is subject to the requirements of Buy America in accordance with Federal Regulation 23 CFR 635.410 Section 1518. Specific requirements are presented in MaineDOT Standard Specification Section 100, Appendix A, Section 3.A., Buy America.

The contractor shall notify all utility companies **10 working days'** prior to beginning any work on this project.

***** Specific information regarding the line voltage can be requested from Emera Maine*****

AERIAL

Aerial utility adjustments **are not** anticipated as part of this project. If any unexpected utility relocations become necessary, they shall be scheduled in compliance with Section 104 of the Standard Specifications and shall be done by the utilities in conjunction with the work by the Contractor.

All of the aerial utilities have lines along and crossing the project location. There may also be underground services from the utility poles routing into homes or businesses.

SUBSURFACE

Subsurface utility adjustments **are not** anticipated as part of this project. If any unexpected utility relocations become necessary, they shall be scheduled in compliance with Section 104 of the Standard Specifications and shall be done by the utilities in conjunction with the work by the Contractor.

Utility Specific Information:

FairPoint Communications:

FairPoint Communications has active subsurface facilities routing along Route #1 in Monticello, Maine. These subsurface facilities exist within the bituminous sidewalk width along the west side of the travel way; starting at the Monticello general store, crossing the Meduxnekeag Bridge (#2545) and terminating approximately 550 feet north. No adjustments are anticipated for the FairPoint facilities.

Towns: Littleton, Maine & Monticello, Maine
Ultra-Bond Wearing Surface, US Route #1
Project: #23302.00
Date: February 14, 2018

Bangor Natural Gas Company (BNG):

Bangor Natural Gas Company has a 6” diameter subsurface pipeline existing within the limits of Route #1 in Monticello, Maine. This pipeline is inactive, and crosses route #1 approximately 930 feet south of the Shanks Road intersection in Littleton; and approximately 2600 feet south of the Clark Road intersection in Monticello. No adjustments are anticipated for the BNG facilities.

MAINTAINING UTILITY LOCATION MARKINGS

The Contractor shall be responsible for maintaining the buried utility location markings following the initial locating by the appropriate utility or their designated representative.

UTILITY SIGNING

Any utility working within the construction limits of this project shall ensure that the traveling public is adequately protected at all times. All work areas shall be signed, lighted, and traffic flaggers employed as determined by field conditions. All traffic controls shall be in accordance with the latest edition of the Manual on Uniform Traffic Control Devices for Streets and Highways, as issued by the Federal Highway Administration.

Project WIN: 23302.00

SPECIAL PROVISION 105
CONSTRUCTION AREA

A Construction Area located in the **Towns of Littleton and Monticello** has been established by the Maine Department of Transportation (MDOT) in accordance with provisions of 29-A § 2382 Maine Revised Statutes Annotated (MRSA).

- (a) The section of highway under construction in Aroostook County, WIN 23302.00 is on US Route 1 beginning 0.38 mi north of Little Road in Littleton and extending northerly 10.21 miles, ending in Monticello.

Per 29-A § 2382 (7) MRSA, the MDOT may “*issue permits for stated periods of time for loads and equipment employed on public way construction projects, United States Government projects or construction of private ways, when within construction areas established by the Department of Transportation. The permit:*

A. Must be procured from the municipal officers for a construction area within that municipality;

B. May require the contractor to be responsible for damage to ways used in the construction areas and may provide for:

(1) Withholding by the agency contracting the work of final payment under contract; or

(2) The furnishing of a bond by the contractor to guarantee suitable repair or payment of damages.

The suitability of repairs or the amount of damage is to be determined by the Department of Transportation on state-maintained ways and bridges, otherwise by the municipal officers;

C. May be granted by the Department of Transportation or by the state engineer in charge of the construction contract; and

D. For construction areas, carries no fee and does not come within the scope of this section.”

The Municipal Officers for the **Towns of Littleton and Monticello** agreed that an Overlimit Permit will be issued to the Contractor for the purpose of using loads and equipment on municipal ways in excess of the limits as specified in 29-A MRSA, on the municipal ways as described in the “Construction Area”.

As noted above, a bond may be required by the municipality, the exact amount of said bond to be determined prior to use of any municipal way. The MDOT will assist in determining the bond amount if requested by the municipality.

The maximum speed limits for trucks on any town way will be 25 mph (40 m per hour) unless a higher legal limit is specifically agreed upon in writing by the Municipal Officers concerned.

Special Provision
Section 105
General Scope of Work
(Limitations of Operations)

- 1) This contract allows for only one paving operation per day unless otherwise authorized by the Resident.
- 2) Traffic will be allowed to travel on milled surfaces on the mainline. After 7 calendar days any milled surfaces needing repair or maintenance, shall be repaired to the satisfaction of the Resident (please see Special Provision 202). All work, equipment and materials required to make repairs shall be at the Contractor's expense. Failure to adequately maintain milled areas will also result in a violation of Special Provision 652. The Contractor shall plan and conduct their work accordingly.
- 3) The Contractor shall plan operations so that the Resident will have sufficient advance notification to provide the necessary inspection and testing. Sufficient notification will be considered 48 hours.
- 4) The contractor may elect to work at night provided they obtain written permission from the municipalities impacted.
- 5) Absences must be requested at least 72 hours in advance and are subject to Department approval based on existing roadway condition, paving deadlines, adherence to schedule, traffic restrictions, detours, etc. The Contractor must assure that the roadway surface and signage are maintained for safe passage of the traveling public during any approved absences. The Contract Completion Date will not be modified due to approved absences.

MaineDOT DBE Project Attainment Target (PAT)
for this Project is **5.7%**

The MaineDOT seeks to meet the specified annual Disadvantaged Business Enterprise (DBE) usage goal set out by 49 CFR 26.45 through the efforts of contractors seeking to employ qualified DBE subcontractors. We seek to meet this goal by race neutral means and do not, at this time, use contract specific requirements for each project. We do however, understand the capacity of Maine's DBE community and the unique characteristics a project may have that would differ from the broad annual goal.

Taking this into consideration, the MaineDOT will review each project and develop an anticipated attainment or Project Attainment Target (PAT) based on several factors that are project specific. Those factors include:

- Scope of Work
- DBE availability according to Specification Item
- Geographic location
- DBE capacity

This PAT is developed to assist contractors to better understand the DBE participation that the MaineDOT can reasonably expect for a specific project. The PAT is NOT a mandate but an assessment of the DBE opportunities that this project could meet or exceed. MaineDOT anticipates that each contractor will make the best effort to reach or exceed the PAT for this project.

Special Provision
Section 107
(Contract Time)

- 1) A 48-hour notice will be required for any changes in the work schedule.
- 2) Once operations commence, for every weekday not worked the Contractor will be charged supplemental liquidated damages per Section 107.7.2 of the Standard Specifications; excluding days lost to inclement weather, holidays, and approved absences.
- 3) The Contractor is advised that no work will be allowed between the dates and times listed below:
 - Friday, May 25, 2018, at sunset to Tuesday, May 29, 2018, at 6:00 a.m.
 - Tuesday, July 3, 2018, at sunset to Thursday, July 5, 2018, at 6:00 a.m.
 - Friday, August 31, 2018, at sunset to Tuesday, September 4, 2018, at 6:00 a.m.

Special Provision
Section 107
Prosecution and Progress
(Contract Time)

This Contract shall be completed within (**74**) continuous calendar days. The Contractor may begin work **Anytime** in accordance with Standard Specification 104.4.2 and upon approval of all required submittals. The Contract Completion Date will be no later than **October 6, 2018.**

At least 21 calendar days prior to the desired Begin Construction Date (**and no later than June 15th**), the Contractor shall submit an **electronic copy of their signed request to begin work and the Begin Construction Date.** This signed request shall be sent read receipt through **email** with their **Schedule of Work**, in accordance with Standard Specification 107.4.2, to **Shawn.Smith@Maine.gov**, **Emory.Lovely@Maine.gov**, **Ryan.Sullivan@Maine.gov**, and **Scott.Bickford@Maine.gov**. The Contractor shall notify all utility contacts listed in the 104 Special Provision and provide the utility contacts the submitted schedule of work within 2 calendar days of the schedule of work submittal. **A penalty in the amount of \$500/day will be assessed for each calendar day or partial calendar day beyond June 15th that the schedule of work is not received.** Upon receipt of the schedule of work, a pre-construction meeting will be scheduled. A Contract Modification will be executed to document the new Contract Completion Date based upon the Begin Construction Date. The modified Contract Completion Date shall not exceed the Contract Completion Date specified in this special provision.

The Contractor may request to adjust the submitted schedule of work and Begin Construction Date once after the initial submittal. The Department will allow adjustments in the Begin Construction Date of up to seven calendar days if the request is made at least 21 calendar days prior to the updated Begin Construction Date. This signed request shall be sent read receipt through **email** with their **Schedule of Work**, in accordance with Standard Specification 107.4.2, to **Shawn.Smith@Maine.gov**, **Emory.Lovely@Maine.gov**, **Ryan.Sullivan@Maine.gov** and **Scott.Bickford@Maine.gov**. The Contractor shall notify all utility contacts listed in the 104 Special Provision and provide the utility contacts the updated schedule of work within 2 calendar days of the request to adjust the Begin Construction Date.

SPECIAL PROVISION
SECTION 107
SCHEDULING OF WORK

Replace Section 107.4.2 with the following:

”107.4.2 Schedule of Work Required Within 21 Days of Contract Execution and before beginning any on-site activities, the Contractor shall provide the Department with its Schedule of Work. The Contractor shall plan the Work, including the activity of Subcontractors, vendors, and suppliers, such that all Work will be performed in Substantial Conformity with its Schedule of Work. The Schedule must include sufficient time for the Department to perform its functions as indicated in this Contract, including QA inspection and testing, approval of the Contractor's TCP, SEWPCP and QCP, and review of Working Drawings.

At a minimum, the Schedule of Work shall include a bar chart which shows the major Work activities, milestones, durations, submittals and approvals, and a timeline. Milestones to be included in the schedule include: (A) start of Work, (B) beginning and ending of planned Work suspensions, (C) Completion of Physical Work, and (D) Completion. If the Contractor Plans to Complete the Work before the specified Completion date, the Schedule shall so indicate.

Any restrictions that affect the Schedule of Work such as paving restrictions or In-Stream Work windows must be charted with the related activities to demonstrate that the Schedule of Work complies with the Contract.

The Department will review the Schedule of Work and provide comments to the Contractor within 20 days of receipt of the schedule. The Contractor will make the requested changes to the schedule and issue the finalized version to the Department.”

SPECIAL PROVISION
SECTION 401 - HOT MIX ASPHALT PAVEMENT

The Standard Specification 401 – Hot Mix Asphalt Pavement, has been modified with the following revisions. All sections not revised by this Supplemental Specification shall be as outlined in Section 401 of the Standard Specifications.

401.07 Hot Mix Asphalt Plant

401.071 General Requirements HMA plants shall conform to AASHTO M156-97.

a. Truck Scales When the hot mix asphalt is to be weighed on scales meeting the requirements of Section 108 - Payment, the scales shall be inspected and sealed by the State Sealer as often as the Department deems necessary to verify their accuracy.

Plant scales shall be checked prior to the start of the paving season, and each time a plant is moved to a new location. Subsequent checks will be made as determined by the Resident. The Contractor will have at least ten 50 pound masses for scale testing.

b. Additives Additives (WMA, anti-strip, etc.) not directly introduced into the binder at the terminal shall be introduced into the HMA plant per the supplier's recommendations and shall be approved by the Asphalt Pavement Engineer, Pavement Quality Manager, or their authorized representative. The system for introducing additives shall be interlocked with the aggregate feed or weigh system to maintain correct proportions for all rates of production and batch sizes. Additive introduction systems shall be controlled by a proportioning device to the amount required on the JMF plus or minus 0.1% of the target. Additive introduction systems shall be interlocked with the plant and the recordation (batch tickets or drum recordation) shall display the additive and the weight and percentage added.

c. Stockpiles HMA plants shall have sufficient space for stockpiles, with a minimum of supply for 2 days production of all aggregate products used in MaineDOT approved mix designs currently under production for the facility at all times. A minimum stockpile supply of 100 ton (70 yards) shall be maintained at all times no matter the production rate for the HMA plant. Stockpiles shall be separated and built to minimize segregation.

401.18 Quality Control Method A, B & C The Contractor shall operate in accordance with the approved Quality Control Plan (QCP) to assure a product meeting the contract requirements. The QCP shall meet the requirements of Section 106.6 - Acceptance and this Section. The Contractor shall not begin paving operations until the Department approves the QCP in writing.

The QCP shall address any items that affect the quality of the Hot Mix Asphalt Pavement including, but not limited to, the following:

- a. JMF(s)
- b. Hot mix asphalt plant details
- c. Stockpile Management (to include provisions for how the requirements of 401.071c will be met)
- d. Make and type of paver(s)
- e. Make and type of rollers including weight, weight per inch of steel wheels, and average contact pressure for pneumatic tired rollers
- f. Name of QCP Administrator, and certification number
- g. Name of Process Control Technician(s) and certification number(s)
- h. Name of Quality Control Technicians(s) and certification number(s)
- i. Mixing & transportation including process for ensuring that truck bodies are clean and free of debris or contamination that could adversely affect the finished pavement
- j. Testing Plan
- k. Laydown operations including longitudinal joint construction, procedures for avoiding paving in inclement weather, type of release agent to be used on trucks tools and rollers, compaction of shoulders, tacking of all joints, methods to ensure that segregation is minimized, procedures to determine the maximum rolling and paving speeds based on best engineering practices as well as past experience in achieving the best possible smoothness of the pavement. Solvent based agents developed to strip asphalts from aggregates will not be allowed as release agents.
- l. Examples of Quality Control forms including a daily plant report, daily paving report, and delivery slip template for any plant to be utilized.
- m. Silo management and details (can show storage for use on project of up to 36 hours)
- n. Provisions for varying mix temperature due to extraordinary conditions or production limitations. If a warm-mix technology is utilized, a proposed target production temperature range (not to exceed 50°F) will be provided for each mix design.
- o. Name and responsibilities of the Responsible onsite Paving Supervisor.
- p. Method for calibration/verification of Density Gauge
- q. A note that all testing will be done in accordance with AASHTO and the MaineDOT Policies and Procedures for HMA Sampling and Testing.
- r. A detailed description of RAP processing, stockpiling and introduction into the plant as well as a note detailing conditions under which the percent of RAP will vary from that specified on the JMF.
- s. A detailed procedure outlining when production will be halted due to QC or Acceptance testing results.
- t. A plan to address the change in PGAB source or supplier and the potential co-mingling of differing PGAB's.
- u. A procedure to take immediate possession of acceptance samples once released by MaineDOT and deliver said samples to the designated acceptance laboratory.
- v. Provisions for how the QCP will be communicated to the Contractor's field personnel

The Contractor shall cease paving operations whenever one of the following occurs on a lot in progress:

- a. Method A: The Pay Factor for VMA, Voids @ N_d , Percent PGAB, composite gradation, VFB, fines to effective binder or density using all Acceptance or all Quality Control tests for the current lot is less than 0.85. No ceasing of paving operations shall be required for fines to effective binder if the mean test value is equal to the LSL or USL and $s = 0$.
- b. Method B: The Pay Factor for VMA, Voids @ N_d , Percent PGAB, composite gradation, VFB, fines to effective binder or density using all Acceptance or all Quality Control tests for the current lot is less than 0.90. No ceasing of paving operations shall be required for fines to effective binder if the mean test value is equal to the LSL or USL and $s = 0$.
- c. Method C: The Pay Factor for Percent PGAB, percent passing the nominal maximum sieve, percent passing 2.36 mm sieve, percent passing 0.300 mm sieve, percent passing 0.075 mm sieve or density using all Acceptance or all available Quality Control tests for the current lot is less than 0.85. No ceasing of paving operations shall be required for percent passing the nominal maximum sieve, percent passing 2.36 mm sieve, percent passing 0.300 mm sieve, or percent passing 0.075 mm sieve if the mean test value is equal to the LSL or USL and $s = 0$.
- d. The Coarse Aggregate Angularity or Fine Aggregate Angularity value falls below the requirements of Table 3: Aggregate Consensus Properties Criteria in Section 703.07 for the design traffic level.
- e. Each of the first 2 control tests for a Method A or B lot fall outside the upper or lower limits for VMA, Voids @ N_d , or Percent PGAB; or under Method C, each of the first 2 control tests for the lot fall outside the upper or lower limits for the nominal maximum, 2.36 mm, 0.300 mm or 0.075 mm sieves, or percent PGAB.
- f. The Flat and Elongated Particles value exceeds 10% by ASTM D4791.
- g. There is any visible damage to the aggregate due to over-densification other than on variable depth shim courses.
- h. The Contractor fails to follow the approved QCP.

401.203 Method C Lot Size will be the entire production per JMF for the project, or if so agreed at the Pre-paving Conference, equal lots of up to 4500 tons, with unanticipated over-runs of up to 1500 ton rolled into the last lot. Sublot sizes shall be 750 ton for mixture properties, 500 ton for base or binder densities and 250 ton for surface densities. The minimum number of sublots for mixture properties shall be 4, and the minimum number of sublots for density shall be five.

TABLE 7: METHOD C ACCEPTANCE LIMITS

Property	USL and LSL
Passing 4.75 mm and larger sieves	Target +/-7%
Passing 2.36 mm to 1.18 mm sieves	Target +/-5%
Passing 0.60 mm	Target +/-4%
Passing 0.30 mm to 0.075 mm sieve	Target +/-2%
PGAB Content	Target +/-0.4%
% TMD (In place density)	95.0% +/- 2.5%

Pay Adjustment Method C

The Department will use density, Performance Graded Asphalt Binder content, and the percent passing the nominal maximum, 2.36 mm, 0.300 mm and 0.075 mm sieves for the type of HMA represented in the JMF. If the PGAB content falls below 0.80, then the PGAB pay factor shall be 0.55.

Density: For mixes having a density requirement, the Department will determine a pay factor using Table 7: Method C Acceptance Limits:

$$PA = (\text{density PF} - 1.0)(Q)(P) \times 0.50$$

PGAB Content and Gradation The Department will determine a pay factor using Table 7: Method C Acceptance Limits. The Department will calculate the price adjustment for Mixture Properties as follows:

$$PA = (\% \text{ Passing Nom. Max PF} - 1.0)(Q)(P) \times 0.05 + (\% \text{ passing 2.36 mm PF} - 1.0)(Q)(P) \times 0.05 + (\% \text{ passing 0.30 mm PF} - 1.0)(Q)(P) \times 0.05 + (\% \text{ passing 0.075 mm PF} - 1.0)(Q)(P) \times 0.10 + (\text{PGAB PF} - 1.0)(Q)(P) \times 0.25$$

401.223 Process for Dispute Resolution (Methods A B & C only)

TABLE 10: DISPUTE RESOLUTION VARIANCE LIMITS

PGAB Content	+/-0.4%
G _{mb}	+/-0.030
G _{mm}	+/-0.020
Voids @ N _d	+/-0.8%
VMA	+/-0.8%
Passing 4.75 mm and larger sieves	+/- 4.0%
Passing 2.36 mm to 0.60 mm sieves	+/- 3.0%
Passing 0.30 mm to 0.15	+/- 2.0 %
0.075 mm sieve	+/- 0.8%

SPECIAL PROVISION
SECTION 403
HOT MIX ASPHALT

Desc. Of Course	Grad Design.	Item Number	Total Thick	No. Of Layers	Comp. Notes
<u>Ultra-Thin Bonded Wearing Course</u>					
<u>Mainline Travelway (As Indicated in Typical)</u>					
Wearing	Type C	462.301	¾"	1	20,27,30
<u>Spot Shims/Delaminated Areas – As Directed by Resident</u>					
Shim	9.5 mm	403.211	variable	1/more	1,2,4,10,11,14

COMPLEMENTARY NOTES

1. The required PGAB for this mixture will meet a **PG 64-28** grading.
2. The incentive/disincentive provisions for density shall not apply. Rollers shall meet the requirements of this special provision. The use of an oscillating steel roller shall be required to compact all mixtures pavements placed on bridge decks.
4. The design traffic level for mix placed shall be 0.3 to <3 million ESALS. The design, verification, Quality Control, and Acceptance tests for this mix will be performed at **50 gyrations**.
10. Section 106.6 Acceptance, (2) Method D.
11. The combined aggregate gradation required for this item shall be classified as a 9.5mm “**fine graded**” mixture, (using the Primary Control Sieve control point) as defined in 703.09.
14. The combined aggregate gradation required for this item shall be classified as a 9.5mm Thin Lift Mixture (TLM) mixture, using the Aggregate Gradation Control Points as defined in 703.09.
20. The Contractor may place the specified HMA pavement course, not to exceed 1 inch compacted depth, over the full single travel lane width, for each production day. If this option is utilized the Contractor will be required to place a matching course of HMA over the adjacent section of travel lane before weekend suspension. The Contractor will also be responsible for installing additional warning signage that clearly defines the centerline elevation differential hazard. Unless otherwise addressed in the contract, the Contractor shall install additional centerline delineation such as a double RPM application, or temporary painted line for centerline at the end of each production day. The Traffic Control Plan shall be amended to include this option and the additional requirements. All signs and traffic control devices will conform to Section 719.01, and Section 652, and will be installed prior to the work, at a maximum spacing of 0.50 mile for the entire length of effected roadway section. On roadways with two-way traffic, the Contractor will be required to place the specified course over the full width of the mainline traveled way being paved prior to opening the sections to weekend or holiday traffic. If this option is utilized, all additional signing, labor, traffic control devices, or incidentals will not be paid for directly, will be considered incidental to the appropriate 652 items.
27. See Special Provision 462 – Ultra Thin Bonded Wearing Course for project specifics.

30. The required PGAB shall be a storage-stable, homogeneous, polymer modified asphalt binder that meets **PG 64E-28** grading requirements in AASHTO M 332. All polymer modified asphalt grades utilized on the Project shall be treated with an approved liquid anti-strip. PG binders shall be treated either at the asphalt source terminal with the required dose rate on the delivery documentation, or at the hot mix asphalt plant utilizing a system integrated with the plants controls that will introduce a minimum 0.50 percent anti-strip by weight of asphalt binder used unless a rate is otherwise recommended by the anti-strip manufacturer. The PGAB and anti-strip blend shall meet the **PG 64E-28** requirements. The Contractor shall provide supporting test data showing the PGAB and anti-strip blend meet the required criteria.

Tack Coat

A tack coat of emulsified asphalt, RS-1, RS-1h, CRS-1 or CRS-1h, Item 409.15 shall be applied to any existing pavement at a rate of approximately 0.030 gal/yd², and on milled pavement approximately 0.05 gal/yd² prior to placing a new course. A fog coat of emulsified asphalt shall be applied between shim /base courses and surface course as well as to any bridge membrane prior to the placement of HMA layers at a rate not to exceed 0.030 gal/yd². Tack used will be paid for at the contract unit price for Item 409.15 Bituminous Tack Coat.

SPECIAL PROVISION
SECTION 400
Pavements

(Emulsified Asphalt Seal Coat with Cover Coat Material)

Description This work consists of furnishing and applying one or more applications of emulsified asphalt sealcoat material with cover coat material on an approved surface in accordance with these specifications, and in reasonably close conformity with the lines shown on the plans or established.

Materials The bituminous material shall meet the applicable requirements of Section 702 – Bituminous Materials. Liquid asphalt grades for the fog coat treatment shall meet the requirements for CSS-1, CSS-1h, CRS-2h, or CRS-2P. The emulsion type selected shall be used for the entire fog seal application areas unless otherwise approved by the Department.

The emulsified asphalt shall be produced with an approved, certified emulsion product, diluted, and thoroughly mixed into a homogenous liquid at the emulsion manufacturing facility. Each load shall be accompanied by a loading invoice listing the material supplier, emulsion type, dilution rate, total quantity loaded, and copy of the undiluted emulsified asphalt product certification. The diluted emulsion shall meet the requirements listed in Table 1 of this specification.

Table 1 – Diluted Asphalt Emulsion for Seal Coat

<u>Test requirements for diluted material</u>	<u>Range</u>
Sieve test %	0 – 0.10
Residue by distillation, %	28 - 40
Penetration	40 - 90
Application Temperature	100 - 180°F

The cover coat material shall be black or dark brown in color. Cover coat material shall be dried and free from moisture, and be of similar type and size as aluminum oxide or silicon carbide abrasive sandblasting grit meeting the “fine” or “extra fine” gradation requirements (ref: Black Beauty abrasive or similar product).

The Contractor may propose an alternative material for the aggregate cover, but will be required to demonstrate the materials compatibility with the emulsion fog seal prior to use on the project.

Equipment Emulsified asphalt sealcoat material application equipment shall meet the requirements specified in Section 409 – Bituminous Tack Coat, subsection 409.05 – Equipment with the addition of the following:

The asphalt distributor shall contain suitable mechanical circulating and heating mechanisms to provide a uniform approved temperature of the entire mass of material. The distributor shall be equipped with a radar type sensor used to measure ground speed, and feed a Digital Volumetric Accumulator capable of measuring gallons applied and distance traveled.

It shall be capable of applying asphalt material in accurately measured quantities at any rate between 0.01 to 2.0 gallons per square yard, of roadway surface, at any length of spray bar up to 16 feet. The distributor shall be capable of maintaining a uniform rate of distribution of asphalt material regardless of change in grade, width or direction of the road. It shall be equipped with an electronic control for setting asphalt pump discharge rate and on/off switching of spray for nozzles in one (1) foot, increments which shall be located in the truck cab. The spray nozzles and pressure system shall provide a sufficient and uniform fan-shaped spray of asphalt material throughout the entire length of the spray bar at all times while operating. The spray shall completely cover the roadway surface receiving the treatment.

The aggregate spreader shall be mounted on the asphalt distributor. It shall have a minimum capacity of 2000 lbs. The hopper shall have vibratory agitation to facilitate material flow. The cover aggregate spinners shall be variable speed, capable of distributing cover aggregate consistently over variable roadway widths in a single pass. All controls shall be cab-mounted and capable of being operated during the application of the asphalt emulsion by the distributor operator.

CONSTRUCTION PROCEDURES

Weather Limitations Emulsified asphalt sealcoat material shall not to be applied when the atmospheric temperature is below 50°F, or pavement surface temperature below 50°F.

Emulsified asphalt sealcoat shall not be applied in wet conditions, or when wet weather conditions are forecasted within a 6 hour period after application.

Preparation of Surface Before application of the emulsion seal coat material the surface shall be thoroughly cleaned of all loose and objectionable material. Preparation of the surface shall be considered incidental to the contract. The Contractor shall be responsible for covering all utility irons just prior to application of emulsion and uncovering utilities after application.

Immediately before applying an emulsified asphalt seal coat, the pavement surface must be cleaned with a road sweeper, power broom to remove dust, dirt, and debris. The pavement surface must be clean and dry before applying the emulsified asphalt sealcoat.

Application Emulsified asphalt seal coat materials shall be applied by a pressure distributor in a uniform, continuous spread over the area to be treated. The target application rate shall be 0.12 gallons per square yard. Emulsion application rates may be adjusted within the range of 0.10 to 0.14 gallons per square yard, as determined by the test section and as directed by the Department. No additional payment consideration or adjustment shall be made unless the required application rate varies from the rate as specified above.

The cover aggregate shall be applied immediately after the emulsion, prior to the emulsion break or cure, and simultaneously with the pressure distributors pass.

Equipment or traffic will not be allowed on the emulsion treated surface until the emulsion has fully cured. Emulsion materials will be applied within the temperature range specified in Section 702.05 – Application Temperatures, or as otherwise listed in this specification. No moisture shall be present on the roadway surface.

The Contractor shall provide dry cover material meeting the requirements of this specification and at a spread rate of 0.35 to 0.75 lbs./ s.y. as determined by the control section. The Contractor shall be required to apply additional cover material above the prescribed rate in the event that excessive emulsion materials are applied. Use of cover material shall be paid for by the pound, by means of verified bagged quantity, or by scaled weight of actual materials applied.

A test section shall be established to verify emulsion and cover coat material target application rates. The section shall be of sufficient length to verify the approximate emulsion use at the prescribed rate. Generally, the length of test section shall be approximately 200-500 linear feet. During emulsion seal material application, adequate provisions shall be made to prevent marring and discoloration of adjacent pavements, structures, vehicles, foliage or personal property. The use of skirting or end panels may be required to control application widths, and limit overspray.

Areas found to lack the proper emulsified asphalt seal coat application rate will require a re-application of emulsion material to meet the required rate. Areas requiring re-application will not be paid for directly but shall be considered incidental to the emulsified asphalt seal coat pay item,

In the event that excessive emulsion materials are applied, the use of cover coat material shall be used to reduce the risk of bleeding and tracking by traffic. Additional aggregate cover material, if required, will be considered incidental to the emulsified asphalt seal coat pay item.

Traffic Control The Contractor may be allowed a limited lane closure lengths if outlined in the contract. If allowed in the contract, traffic volumes shall be monitored to determine peak traffic levels, and lane closures shall be allowed outside peak traffic level times. The Traffic Control Plan will be amended to address traffic control at intersections, businesses, or other high traffic areas. Additional signage shall be used to at .5 mile intervals to warn motorists to stay out of the closed lane and off the sealant. When mainline travelway sealing work is required, adequate quantity and properly spaced cones for travelway delineation along with cones or barricades shall be required. Whether treating travelway, or shoulders, cones or barricades shall be placed across the treated area every 500 ft, immediately after the emulsion and aggregate application, to prevent vehicles from traveling through the sealant during the cure period.

All traffic shall be kept off the emulsified asphalt seal coat areas for a minimum of 4 hours or until curing is complete. The emulsified asphalt seal coat surface will be considered cured when the emulsion and cover coat material does not track off the treated surface and there are no visible uncured emulsion on the surface. The Contractor may elect to use a polymer modified emulsion to further reduce cure time. No additional payment will be made should a polymer modified emulsion be used.

METHOD OF MEASUREMENT AND BASIS OF PAYMENT

Method of Measurement The Department will measure the emulsified asphalt seal coat by the square meter (square yard). Payment will be for the actual number of square yards applied in accordance with the typicals, Standard Specifications, and Section 109 - Measurement and Payment. Payment for the cover coat material will be paid for by the pound, verified by independent scale checks for bagged or bulk products. Payment shall be full compensation for all labor, materials and equipment required to complete the work in accordance with these specifications.

Basis of Payment The Department will pay for the Work, in place and accepted, in accordance with the applicable sections of the Special Provisions at the contract unit price per square yard applied, and by the pound applied.

Payment will be made under:

<u>Pay Item</u>	<u>Pay Unit</u>
410.151 Emulsified Asphalt Seal Coat, Applied	Square Yard
410.161 Cover Coat Material, Sand	Pound

SPECIAL PROVISION
SECTION 424
ASPHALT RUBBER CRACK SEALER

Description This work shall consist of furnishing all labor, equipment and materials necessary to clean and seal longitudinal and transverse joints in bituminous concrete pavement courses. Materials are to be thoroughly applied to seal the cracks. This work shall consist of the furnishing and placement of crack sealing material in the cracks of existing bituminous concrete pavement in accordance with these Special Provisions. This work shall include shall consist of crack cleaning and drying, material supply, preparation and application, material finishing or shaping, and providing and installing barrier material or curing materials if required.

Materials Asphalt Rubber Crack Sealer shall be an asphalt and rubber compound designed for a temperature range of 64-28 °C, and which improves the strength and performance of the base asphalt cement. Hot pour rubber crack sealant material shall conform to ASTM D-6690, Type II.

Cone Penetration	90 max
Flow @ 60°C [140°F]	< 1/4 inch
Bond, non-immersed	Three ½ inch specimens pass 3 cycles @ 50% extension @ -20
Resilience, %	N/A
Asphalt Compatibility, ASTM D5329	pass*

* There shall be no failure in adhesion, formation of any oily exudate at the interface between the sealant and asphaltic concrete or other deleterious effects on the asphaltic concrete or sealant when tested at 140°F.

The contractor shall provide the Resident or authorized representative with a copy of the material manufacturer's recommendations pertaining to heating, application, and reheating prior to the beginning of operations or the changing of materials

CONSTRUCTION REQUIREMENTS

Weather Asphalt Rubber Crack Sealer shall not be applied on a wet surface, or when the atmospheric temperature is below 50°F in a shaded area at the job site, or when weather conditions are otherwise unfavorable to proper construction procedures.

Equipment Equipment used in the performance of the work shall be subject to the Resident's or authorized representative's approval and shall be maintained in a satisfactory working condition at all times.

- (a) Air Compressor: Air compressors shall be portable and capable of furnishing not less than 4 yd³ of air per minute at not less than 90 psi pressure at the nozzle. The compressor shall be equipped with traps that will maintain the compressed air free of oil and water.
- (b) Sweeper: Manually operated, gas powered air-broom or self-propelled sweeper designed especially for use in cleaning pavements shall be used to remove debris, dirt, and dust from the cracks.
- (c) Hot Air Lance: Should operate with propane and compressed air in combination at 2000°F - 3000°F, exit air heated at 1000 ft/s. The lance should draw propane from no smaller than a 100 lb tank using separate hoses for propane and air draw. The hoses shall be wrapped together with reflectorized wrap to keep them together and to protect workers in low light situations.
- (d) Hand Tools: Shall consist of V-shaped squeegee, brooms, shovels, metal bars with chisel shaped ends, and any other tools which may be satisfactorily used to accomplish this work.
- (e) Melting Kettle: The unit used to melt the joint sealing compound shall be a double boiler, indirect fired type. The space between inner and outer shells shall be filled with a suitable heat transfer oil or substitute having a flash point of not less than 608°F. The kettle shall be equipped with a satisfactory means of agitating and mixing the joint sealer at all times. This may be accomplished by continuous stirring with mechanically operated paddles and/or a continuous circulating gear pump attached to the heating unit. The kettle must be equipped with thermostatic control calibrated between 200°F and 550°F.

Preparations of Cracks All cracks greater than ¼ inch shall be blown free of loose material, dirt, vegetation, and other debris by high pressure air. Material removed from the crack shall be removed from the pavement surface by means of a power sweeper or appropriate hand tools as required. Cracks showing evidence of vegetation after being blown out shall be additionally cleaned by appropriate hand tools and additionally blown out. All cracks must be blown and heated via the hot air lance 10 minutes prior to the crack being sealed. Distance between the hot air lance and the crack sealing unit should be no more than 50 ft to eliminate reinvasion of water, debris, and other incompressible materials. All debris, vegetation, and water shall be removed to enhance adhesion of the crack sealing material. THIS WORK SHALL NOT BE DONE IN INCLEMENT WEATHER.

Preparation and Placement of Sealer The rubber crack sealer material shall be heated and applied at the temperature specified by the manufacturer and approved by the Resident or authorized representative. Any material that has been heated above the manufacturer's specification shall not be used. Material that is reheated or held at temperature for an extended period of time may be used as allowed by the manufacturer's specification and approval of the Resident or authorized representative. The Contractor shall provide the Resident or authorized representative with a suitable device for verifying the sealant temperature in the kettle and at the application site.

Any over application or spills are to be removed to the satisfaction of the Resident or authorized representative. Any sealed areas with damaged or contaminated sealer or visible voids are to be removed, prepared and resealed.

Sealer shall be delivered to the crack while the cracks are still hot from the hot air lance preparation through a pressure hose line and applicator shoe. Generally, the shoe width and the sealer overbanding area shall range from 1 inch – 1.5 inch. Overbanding width may vary from the range specified depending on the width and severity of the cracks. The applicator shall be followed by a V-shaped squeegee to minimize the thickness of the overband. The sealer shall be applied at a rate that produces a coating thickness of 1/8 inch, typical. Any loose material on the surface or in the crack, which may contaminate the crack sealer or impede bonding of the sealant to the pavement, is to be removed by hand tools prior to crack filling. No crack filling material shall be applied in a crack that is wet or where frost, snow, or ice is present. The ambient air temperature must be 50 or higher.

If the sealed area is to be opened to traffic immediately, a barrier material such as Glenzoil or an equivalent product approved by the Resident shall be provided by the Contractor and shall be applied to the crack sealer to prevent pickup as directed by the Resident or authorized representative.

If the sealed areas are to be paved over with a hot mix treatment a 48 hour minimum cure time will be required. Cure times may be extended if excessive pick-up of the crack sealants occurs.

Quality of Work Excess of spilled sealer shall be removed from the pavement by approved methods and discarded. Any quality of work determined to be below normal acceptable standards will not be accepted, and will be corrected and/or replaced as directed by the Resident or authorized representative.

Method of Measurement Asphalt Rubber Crack Sealer will be measured by the pound of sealant used. The manufacturer's weights of the sealant will be accepted as the basis for measurement.

Basis of Payment The accepted quantity of Asphalt Rubber Crack Sealer will be paid for at the contract unit price per pound complete in place. This price shall be full compensation for furnishing and placing crack sealer, including cleaning cracks and furnishing and placing barrier materials if necessary.

Payment will be made under:

<u>Pay Item</u>	<u>Pay Unit</u>
424.323 Asphalt Rubber Crack Sealer, Applied	Pound

SPECIAL PROVISION
SECTION 462
GAP-GRADED HMA
(Ultra-Thin Bonded Wearing Course)

The following subsections of the most current version of Specification 401 – Hot Mix Asphalt Pavements have been revised and amended by the following:

Description This work shall be constructed in accordance with the applicable referenced sections of Division 400 – Pavements; Section 401 – Hot Mix Asphalt Pavement, and the requirements of Section 106 – Quality. All sections not revised by this Special Provision shall be as outlined in the Special Provision 400 Pavements, Section 401 – Hot Mix Asphalt Pavement. References to Standard Specifications, Special Provisions, or other documents, shall be determined as the most current version available at the time of bid, or as amended. The Ultra-Thin Bonded Wearing Course consists of a warm polymer modified asphalt emulsion tack coat followed immediately with an Ultra-Thin hot mix asphalt wearing course. The tack coat is spray applied immediately prior to the application of the wearing course to produce a durable wearing surface that can be opened to traffic. The finished surface treatment has a nominal thickness of ½”, for Type A, ⅝” for Type B, and ¾” for Type C.

MATERIALS

The Contractor shall formulate and submit to the Department, a job mix formula (JMF) that satisfies the design general limits listed in Table 1 – Mixture requirements. The JMF aims shall not fall outside the general design limits.

TABLE 1: COMPOSITE GRADATION

AASHTO Standard Sieve Size	Total % Passing by Weight		
	Type A - ¼”	Type B – ⅜”	Type C - ½”
19 mm (¾”)	-	-	100
12.5 mm (½”)	-	100	85-100
9.5 mm (⅜”)	97-100	85-100	45-85
4.75 mm (#4)	40-60	24-41	24-41
2.36 mm (#8)	21-33	21-33	21-33
1.18 mm (#16)	15-26	15-26	15-26
0.60 mm (#30)	11-20	11-20	11-20
0.30 mm (#50)	8-16	8-16	8-16
0.15 mm (#100)	5-10	5-10	5-10
0.075 mm (#200)	4.0-7.0	4.0-7.0	4.0-7.0
Minimum % PGAB	5.1	5.0	5.0

*Note: All aggregate percentages are based on the total weight of the aggregate. The composite gradation for each individual Type of mixture shall meet the gradation requirements of Table 1.

The estimated PG binder film thickness shall be calculated for the submitted mix design. Designs with estimated film thickness less than 10 microns may be approved pending successful placement in the field. The estimated film thickness of asphalt shall be calculated using the effective asphalt content in conjunction with the surface area for the aggregates in the JMF according to the following formula and the factors in Table 2:

$$FT = \frac{AC \cdot 1000}{SA \cdot SG}$$

where: *FT* = film thickness (microns)
AC = asphalt content of mix design (%)
SA = total surface area of aggregate (SM/Kg)*
SG = specific gravity of asphalt

* Surface area is calculated by multiplying the percent passing for the design by the factors in the table below for each sieve size and summing the resultant values.

TABLE 2: SURFACE AREA FACTORS

AASHTO Standard Sieve Size	Surface Area Factors (SM/Kg)		
	Type A - 1/4"	Type B - 3/8"	Type C - 1/2"
19 mm (3/4")	-	-	0.41
12.5 mm (1/2")	-	0.41	0
9.5 mm (3/8")	0.41	0	0
4.75 mm (#4)	0.41	0.41	0.41
2.36 mm (#8)	0.82	0.82	0.82
1.18 mm (#16)	1.64	1.64	1.64
0.60 mm (#30)	2.87	2.87	2.87
0.30 mm (#50)	6.14	6.14	6.14
0.15 mm (#100)	12.29	12.29	12.29
0.075 mm (#200)	32.77	32.77	32.77

COARSE AGGREGATE

The single size coarse aggregate shall be nominal 6.3 mm (1/4") for Type A, 9.5 mm (3/8") for Type B, and 12.5 mm (1/2") for Type C. These are recommended requirements only listed in Table 3 – Coarse Aggregate Gradations.

TABLE 3: COARSE AGGREGATE GRADATIONS

AASHTO Standard Sieve Size	Total % Passing by Weight		
	A	B	C
12.5 mm, (1/2")	-	100	85-100
9.5 mm, (3/8")	100	85-100	25-80
6.3 mm, (1/4")	60-100	0-15	0-15
4.75 mm, (#4)	10-45	0-3	0-3
2.36 mm, (#8)	0-3	-	-
1.18 mm, (#16)	-	-	-

FINE AGGREGATE

The fine aggregate shall be 100% crushed. These are recommended requirements only listed in Table 4 – Fine Aggregate Gradations.

TABLE 4: FINE AGGREGATE GRADATION

Screen Size	% Passing
4.75 mm, (#4)	95-100
2.36 mm, (#8)	70-90
1.18 mm, (#16)	50-70
0.60 mm, (#30)	35-55
0.30 mm, (#50)	25-40
0.15 mm, (#100)	15-28
0.075 mm, (#200)	10-17

AGGREGATES

Aggregates used shall be from an approved source and shall meet the requirements of section 703.07 for 3.0 to < 10 million ESALs, and as modified by items 1 through 7 listed below.

1. Individual coarse aggregates sources shall meet a Micro-Deval (AASHTO T 327) value of 18 or less.
2. Individual coarse aggregates sources shall have a maximum LA Abrasion (AASHTO T96) of 30.
3. Absorption by AASHTO T 84 shall be less than 2.0% for fine aggregate blends.
4. Absorption by AASHTO T 85 shall be less than 2.0% for coarse aggregate blends.
5. Aggregates shall have a minimum sand equivalent of 45, (AASHTO T 176), and the fine aggregate shall be 100% crushed.
6. 95 % of the aggregate shall have at least a single face crushed and 85% shall have 2 or more crushed.
7. Percent by weight of Flat and Elongated particles shall be (5:1 ratio) with 10% maximum.
8. Coarse aggregates, when measured in any dimension, shall not contain particles larger than the lift being placed or $\frac{3}{4}$ inch, whichever is less.

The Contractor shall test all materials and provide copies of all test results to the Department for materials utilized in the completion of the work. The Contractors' test results shall be submitted to the Department along with the mix design submittal in accordance with the MaineDOT HMA Policy and Procedures Manual.

Mineral Filler Hydrated lime, fly ash, Hot Mix Asphalt plant baghouse fines, or Portland cement may be acceptable as mineral filler.

Typical acceptable gradation: 100% passing 0.60 mm, (#30)
75-100% passing 0.075 mm, (#200).

Performance Graded Asphalt Binder Unless otherwise shown in the contract bid items or noted in Special Provision 403 - Hot Bituminous Pavement, all asphalt binders shall meet a 64-28 PGAB grade. The Contractor may use an approved chemical or wax based warm mix additive when producing UTBWC mixtures using modified PGAB such as 64E-28.

Emulsified Tack Coat Tack Coat shall be modified with latex, natural or synthetic, and shall be certified as meeting the requirements of ASTM D2397 except as modified in Table 5 – Tack Coat Material Properties. It is required that the latex be co-milled at the bulk emulsion facility, to ensure complete and balanced blending. CRS-1P asphalt grade emulsions shall have a minimum asphalt content ratio of 63%.

TABLE 5: TACK COAT MATERIAL PROPERTIES

Property	Method	Minimum	Maximum
Latex Content, % Mass of Total Residue		3.0	
Viscosity at 25 deg C, (Sec.)	ASTM D244	20	100
Setting Time, Minutes	Observation	3	7
Demulsibility, % by wt. Residue	ASTM D244	40	
Penetration , 25 deg C (77 deg F)	T 49	60	150

Weather and Seasonal Limitations All work shall be in accordance with Division 400 – Pavements; Section 401 – Hot Mix Asphalt Pavement , subsection 401.06- Weather and Seasonal Limitations, with the exception of the following revisions;

The minimum ambient air temperature for application of the tack coat and placement of the wearing course shall be 50° F as determined by an approved thermometer (placed at the paving location). The Contractor shall place Ultra-Thin Bonded Wearing Course as travelway and adjacent shoulders between the dates of May 15th and the Saturday following September 15th. The Contractor shall place Ultra-Thin Bonded Wearing Course as travelway or adjacent shoulders between the dates of June 1st and the Saturday following September 1st during conditions defined as “night work”, either by contract requirement or Contractor option. All work and materials required to prepare the project for winter suspension will be considered incidental to the contract.

EQUIPMENT

Spray Pavers The spray paver shall be configured to spray tack at the specified rate, and apply hot mix asphalt seconds later. The spray bar shall be located just ahead of the paver’s auger, and distribute the liquid through computer-controlled, self-cleaning valves. An onboard microprocessor shall be capable of precisely controlling the rate of flow interlocked to the paver speed. Spray valves shall also be controlled manually if needed.

The paver shall have a receiving hopper with sufficient capacity for a uniform spreading operation and a mixture distribution system to place the mixture uniformly, without segregation. The screed assembly shall produce a finished surface of the uniform texture without tearing, shoving, or gouging the mixture.

The self-priming spray paver must be capable of spraying the tack coat, applying the hot asphalt overlay and smoothing the surface of the mat being paved in one pass, at the rate of 33-98 feet per minute. The self-priming spray paver must incorporate a receiving hopper, feed conveyor, heated or insulated storage tank for emulsion, metered tack coat spray bar and a variable width, heated, ironing type screed. The self-priming spray paver shall be a track or rubber tire mounted highway class paver with a minimum combined tractor and screed weight of 44,000 pounds, and a minimum main screed width of 8 feet. All paver screeds shall be outfitted with auger and tunnel extensions as required to distribute the mix within two feet of the end gate. All pavers shall have power extendible, activated, and heated screed extensions designed by the manufacturer for highway paving. Screeds shall be configured to place mixtures to the required width, crown, and breakpoints as directed by the Department. The paver must have a material receiving hopper size capable of accepting haul trucks, and be of sufficient size and weight to maintain the required rate of placement, line of travel, depth, and cross section while engaged with a loaded tri-axle or trailer haul unit. The screed must be sized to place the mixture over the entire lane width being paved in one pass. It shall also have the ability to be positively crowned at the center of lane and have adjustable extensions to accommodate the desired pavement width and cross sectional profile. The Contractor shall operate the paver in such a manner as to produce a visually uniform surface texture. Any UTBWC that becomes visually unacceptable due to mixture cooling, checking, segregation or deformation as a result of an interruption in mix delivery, or excessive delays in re-charging the emulsion tanks shall be removed and replaced with material that meets contract specifications at no cost to the Department.

Rollers The Contractor shall use 7 foot wide double drum steel wheeled rollers weighing at least 8 to 10 ton, that are equipped with functioning water systems and scrapers to prevent the fresh mix from adhering to the roller drums. If the rollers narrower than 7 foot are to be used, the Contractor will be required to use additional rollers or slow placement speed of the paver to ensure full mat coverage is made immediately behind the spray paver.

CONSTRUCTION DETAILS

Surface Preparation The Contractor shall remove painted striping, mill the existing pavement surface as described in the contract documents, crack seal as required by the contract documents, and sweep the roadway as needed prior to the surface treatment. Stripe removal, milling and crack seal will be paid for under the appropriate contract items.

Milling shall be accomplished with a medium cut or finer drum and be paid under item 202.2023 (Medium Textured Pavement Removal). All milling shall conform to the requirements of Section 202-Removing Structures and Obstructions, subsection 202.061-Removing Pavement Surface. The rotary drum shall utilize carbide tip tools spaced not more than $\frac{5}{16}$ inches (8mm) apart and a minimum triple wrap configuration. The difference in height from the top of any ridge to the bottom of the groove adjacent to that ridge shall not exceed 1/8 inch. The forward speed of the milling machine shall be adjusted to produce a milled surface meeting the groove spacing, groove depth, and surface tolerance requirements of this specification. The tools on the revolving cutting drum must be continually maintained and shall be replaced as warranted to provide a uniform pavement texture. The Department may evaluate the texture of the milled surface for information purposes by performing the Sand Patch test according to ASTM E 965.

The Contractor shall locate and remove all objects in the pavement through the work area that would be detrimental to the planing or grinding machine. Any structures or obstructions left within the travel lane or shoulders shall have tapers installed according to Standard Detail 202(01). The finished milled surface will be inspected before being accepted, and any deviations in the profile exceeding 1/2 inch under a 16 foot string line or straightedge placed parallel to the centerline will be corrected. . Any deviations in the milled surface between matching passes or operations, measured transversely to centerline that exceed 1/8 inch under a 10 foot string line or straightedge placed transversely to centerline will be corrected. All corrections will be made with approved methods and materials. Any areas that require corrective measures will be subject to the same acceptance tolerances. Excess material that becomes bonded to the milled surface will be removed to the Resident's satisfaction before the area is accepted.

The Contractor will be allowed run traffic over milled surfaces for up to 21 calendar days unless otherwise noted in Special Provision Section 105 – Limitations of Operations. The day count will not count the shift when milling the section started, but will begin the following shift after the section milled is opened to traffic. The Traffic Control Plan shall be amended to include additional signing, labor, traffic control devices, or incidentals required. Should the milled surfaces be exposed to traffic beyond the days allowed by this Special Provision or Special Provision Section 105 – Limitations of Operations, the Contractor will be assessed a Traffic Control Violation for each calendar day beyond the allowed days.

Weepers shall be ground across the full width sections adjacent shoulders or remaining pavement surface matching the milled travel way or shoulder milled depth to minimize water ponding in any lanes carrying traffic. Weepers shall typically be 18 – 24” inches in width, installed along each lane, at a frequency of approximately one per half mile at locations as directed by the Resident or in areas that will provide drainage for the milled areas. Installation of weepers will not be paid for directly but will be considered incidental to the contracts pavement removal item. The replacement of mix in the weeper locations shall be performed concurrently within the Ultra-Thin Bonded Wearing Course placement operation closure using the HMA produced for the UTBWC or a MaineDOT approved 9.5mm HMA. There will be no separate payment for repaving the weeper locations as they are considered incidental to the square yard price for Ultra-Thin Bonded Wearing Course.

Crack sealing, if required in the contract, will be paid under the appropriate crack seal item. The Contractor shall crack seal transverse and longitudinal cracks as considered appropriate. Unless otherwise directed cracks shall be flush filled with minimal over-banding, and the material type and shall conform to ASTM D-6690, Type II or AASHTO M 324, and paid under the appropriate Type II crack seal item.

Spot shims or leveling course, if required by the Department, shall be paid for under the appropriate 403.211 - 9.5mm shim unit price included in the contract.

Sweeping will not be paid for directly, but shall be included in the 462.30 or 462.301 - Ultra-Thin Bonded Wearing Course contract price.

Application The screed on the paver shall be heated to a temperature between 275°F-335°F before placing Ultra-Thin Bonded Wearing Course on the roadway. Apply the tack coat meeting the requirements of Table 5 at a temperature of 120° - 180° F. The application of tack coat shall be uniform across the entire width to be overlaid, at a rate of 0.20 - 0.25 gallons per square yard, depending upon the existing surface texture. Field adjustments to the target application rate of tack coat shall be determined based upon the existing surface condition of the pavement. The tack coat application rate may be adjusted to 0.17-0.25 gallons per square yard if used over newly placed HMA levelling course. Adjustments to the tack coat target application rate shall be approved by the Department.

The Contractor shall make all efforts to minimize walking on the unrolled mat. Displacement, marring, or depressions that result from walking on or across the mat will require immediate repair before rolling. Repeated incidences of irreparable surface defects may result in work stoppage until the issue is resolved.

A tack coat of CRS-1P shall be applied to the vertical transverse joint surface and the underlying roadway at each transverse joint takeoff. Should the spray paver be unable to apply tack coat to the vertical transverse joint when paving a tack coat of CRS-1P or RS-1 shall be applied to the vertical joint and adjacent surfaces for at least the first 10 feet. The application rate shall be a minimum of 0.05 gal/s.y. for the tack application at transverse joints. The Contractor shall continuously monitor the rate of spray. No equipment shall come in contact with the tack coat before the hot mix asphalt wearing course is applied. Immediately after applying the tack coat, the contractor shall apply the hot mix asphalt overlay across the full width of the tack coat at a temperature of 290° - 335° F.

Compaction The Contractor shall begin compaction immediately behind the spray paver after the application of wearing course. The roller(s) shall make a minimum of two passes. The roller(s) will not be allowed to stop on the freshly placed wearing course. The Contractor shall use an adequate number of rollers to complete compaction and aggregate seating before the pavement surface temperature falls below 185° F for 64-28 PGABs, or below 210° F for PG 64E-28. The Contractor shall provide an additional roller if the Contractor elects to pave travelway and adjacent shoulder concurrently and the adjacent shoulder exceeds four feet in width. The Contractor shall protect the wearing course from traffic until the rolling operation is complete and the material has cooled sufficiently to resist damage.

Quality Control All work shall be in accordance with Division 400 – Pavements; Section 401 – Hot Mix Asphalt Pavement , subsection 401.18- Quality Control Method A, B & C, with the exception of the following revisions;

The Contractor shall sample, test, and evaluate Hot Mix Asphalt Pavement in accordance with the following minimum frequencies:

TABLE 6: MINIMUM QUALITY CONTROL FREQUENCIES

Test or Action	Frequency	Test Method
Temperature of mix	6 per day at street and plant	-
Temperature of mat	4 per day	-
Fines / Effective Binder	1 per 500 ton	AASHTO T 312*
Gradation	1 per 500 ton	AASHTO T30
PGAB content	1 per 500 ton	AASHTO T164 or T308
Rice Specific Gravity	1 per 500 ton	AASHTO T209
Coarse Aggregate Angularity	1 per 5000 ton	ASTM D5821
Flat and Elongated Particles	1 Per 5000 ton	ASTM D4791
Fine Aggregate Angularity	1 Per 5000 ton	AASHTO T304

The Contractor shall cease paving operations whenever one of the following occurs on a lot in progress:

- The Pay Factor for Percent PGAB, percent passing the nominal maximum sieve, percent passing 2.36 mm sieve, percent passing 0.300 mm sieve, or percent passing 0.075 mm sieve using all Acceptance or all available Quality Control tests for the current lot is less than 0.85.
- The Contractor fails to follow the approved QCP.

Acceptance Acceptance shall be in accordance with this Special Provision. The Lot size will be the entire production per JMF for the project, or if so agreed at the Pre-paving Conference, equal lots of up to 4,500 tons (110,000 square yards). Remaining tonnage (square yards) may be rolled into the last lot allowed up to a maximum size of 6,000 tons (150,000 square yards). Sublot sizes shall be 750 tons (25,000 square yards) for mixture properties, with unanticipated over-runs of up to one-half of the sublot rolled into the last sublot. The minimum number of sublots per Lot for mixture properties shall be five.

TABLE 7: ACCEPTANCE CRITERIA

PROPERTIES	POINT OF SAMPLING	TEST METHOD
Gradation	Paver Hopper	AASHTO T30
PGAB Content	Paver Hopper	AASHTO T308

TABLE 8: ACCEPTANCE LIMITS

Property	USL and LSL
Passing NMAS sieve	Target +/-5%*
Passing 4.75 mm and larger sieves	Target +/-5%
Passing 2.36 mm to 1.18 mm sieves	Target +/-3%
Passing 0.60 mm	Target +/-3%
Passing 0.30 mm to 0.15 mm sieve	Target +/-2%
Passing 0.075 mm sieve	Target +/-2%*
PGAB Content	Target +/-0.3%

* The mixture shall be produced to comply with the control points outlined in Table 1.

Pay Adjustment The Department will sample, test, and evaluate Hot Mix Asphalt Pavement in accordance with Section 106 - Quality and Section 401.20 - Acceptance, of Division 400 – Pavements, and this Special Provision.

The Department will use Performance Graded Asphalt Binder content, and the screen sizes listed in this specification for the type of mixture represented in the JMF. If any pay factor for any single property falls below 0.85, the Contractor shall cease production at the HMA plant.. If the percent passing the nominal maximum sieve, the 2.36 mm sieve, the 0.300 mm sieve or the 0.075 mm sieve falls below 0.80, then the composite pay factor for the four sieves shall be 0.55.

PGAB Content and Gradation The Department will determine a pay factor for each square yard using Table 8: Acceptance Limits. The Department will calculate the price adjustment for Mixture Properties as follows:

$$PA = 0.70[(\% \text{ Passing Nom. Max PF}-1.0)(Q)(P)X0.05+(\% \text{ passing 2.36 mm PF}-1.0)(Q)(P)X0.05+(\% \text{ passing 0.30 mm PF}-1.0)(Q)(P)X0.05+(\% \text{ passing 0.075 mm PF}-1.0)(Q)(P)X0.10+(\text{PGAB PF}-1.0)(Q)(P)X0.25]$$

Dispute Resolution All work shall be in accordance with Division 400 – Pavements; Section 401 – Hot Mix Asphalt Pavement , subsection 401.223 Process for Dispute Resolution, with the exception of the following revisions;

Outcome The value of any disputed result or property reported for the initial Acceptance sample shall stand if the value reported for the dispute resolution sample is not closer to the value the Contractor reported for their split sample than to the value reported for the initial Acceptance sample. If the value reported for the dispute resolution falls precisely half-way between the other two values the value reported for the dispute resolution will replace the original acceptance value. Otherwise, the value reported for the dispute resolution sample will replace the value reported for the initial Acceptance sample, and will be used to re-calculate any other affected results or properties.

TABLE 9: DISPUTE RESOLUTION VARIANCE LIMITS

PGAB Content	+/-0.4%
Passing 4.75 mm and larger sieves	+/- 4.0%
Passing 2.36 mm to 0.60 mm sieves	+/- 3.0%
Passing 0.30 mm to 0.15	+/- 2.0 %
0.075 mm sieve	+/- 0.8%

Method of Measurement The Ultra-Thin Bonded Wearing Course shall be measured by the square yard.

Basis of Payment The accepted quantity of Ultra-Thin Bonded Wearing Course will be paid for at the contract unit price per square yard, complete in-place which price will be full compensation for furnishing all equipment, material, labor, and all incidentals necessary to complete the work. Pay adjustments may be made as outlined in this specification.

Payments will be made under:

<u>Pay Item</u>		<u>Pay Unit</u>
462.30	Ultra-Thin Bonded Wearing Course	Square Yard
462.301	Polymer-Modified Ultra-Thin Bonded Wearing Course	Square Yard

SPECIAL PROVISION
SECTION 631
EQUIPMENT RENTAL
EQUIPMENT REQUIREMENTS

Amend Section 631 by adding the following to the noted subsections:

631.03 General

Equipment shall be capable of grinding small areas of pavement up to 6” in depth in accordance with Section 202, per plans, or as directed by the Resident.

631.08 Basis of Payment

Payment will be made under:

<u>Pay Item</u>		<u>Pay Unit</u>
631.212	Small Pavement Grinder (Including Operator)	Hour

SPECIAL PROVISION
SECTION 652
MAINTENANCE OF TRAFFIC

Approaches. Approach signing shall include the following signs at a minimum. Field conditions may warrant the use of additional signs as determined by the Resident..

Road Work Next X* Miles
Road Work 500 Feet (Ahead)
End Road Work

Work Areas. At each work site, signs and channelizing devices shall be used as directed by the Resident.

Signs include:

Road Work xxxx¹.
One Lane Road Ahead
Flagger Sign

Other typical signs include:

Be Prepared to Stop
Low Shoulder
Bump
Pavement Ends

The above lists of Approach signs and Work Area signs are representative of the contract requirements. Other sign legends may be required.

The Contractor shall conduct their operations in such a manner that the roadway will not be restricted to one lane for more than 2,500 feet at each work area. To encourage quality paving in warm-weather conditions, the length can be extended to 4,000 feet depending on the traffic impacts. Where more than one work area restricts traffic to one lane operation, these work areas shall be separated by at least 1 mile of two way operation.

Temporary Centerline A temporary centerline shall be placed each day on all new pavement to be used by traffic. The temporary centerline, when specified of reflectorized traffic paint, shall conform to the standard marking patterns used for permanent markings. Failure to apply a temporary centerline daily will result in a Traffic Control Violation and suspension of paving operations until temporary markers are applied to all previously placed pavement.

¹ “Road Work Ahead” to be used in short duration operations and “Road Work xx feet” to be used in stationary operations as directed by the Resident.

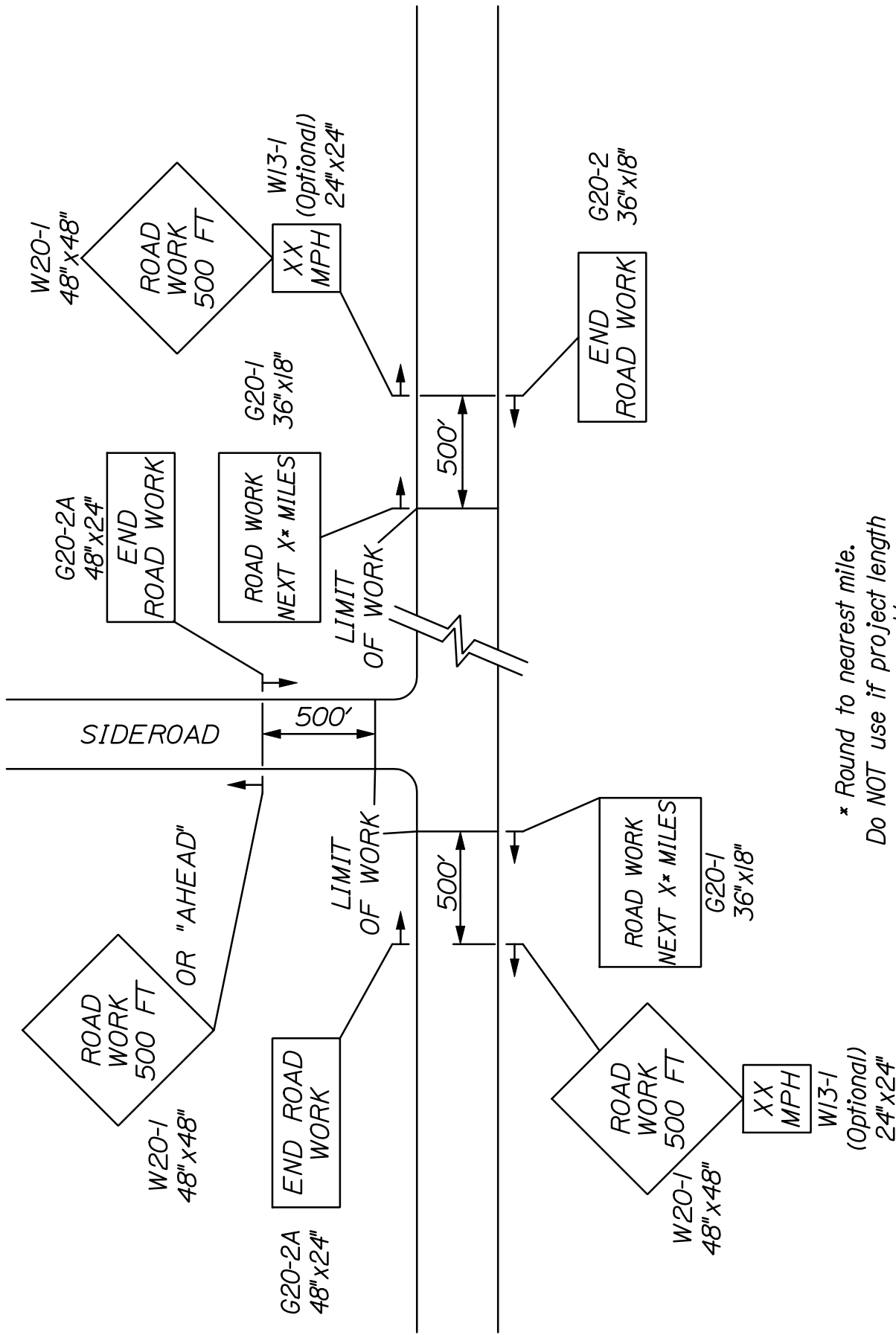

* Round to nearest mile.
 Do NOT use if project length
 is less than a 1 1/2 mile.

~ PROJECT APPROACH SIGNING ~
 TWO WAY TRAFFIC

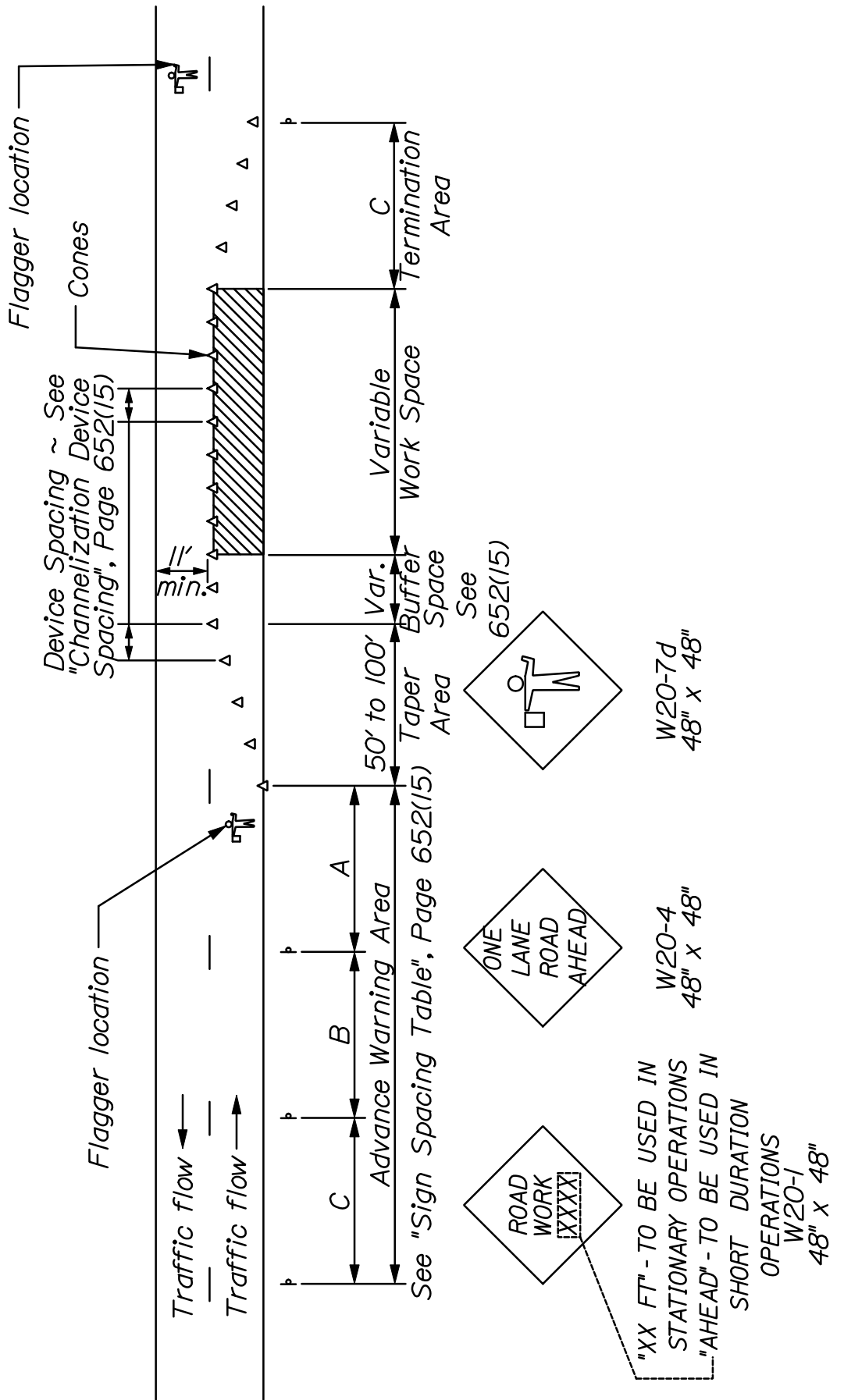

~ TYPICAL APPLICATION: TWO -WAY, TWO LANE ROADWAY,
 CLOSING ONE LANE USING FLAGGERS ~

* Formulas for L are as follows:
For speed limits of 40 mph or less:

$$L = \frac{WS^2}{60}$$

For speed limits of 45 mph or greater:

$$L = WS$$

* Formulas for L are as follows:

A minimum of 5 channelization devices shall be used in the taper.

TYPE OF TAPER	TAPER LENGTH (L)*
Merging Taper	at least L
Shifting Taper	at least 0.5 L
Shoulder Taper	at least 0.33 L
One-Lane, Two-Way Traffic Taper	100 ft maximum
Downstream Taper	100 ft per lane

CHANNELIZATION DEVICE SPACING

The spacing of channelization devices shall not exceed a distance in feet equal to 1.0 times the speed limit in mph when used for taper channelization, and a distance in feet of 2.0 times the speed limit in mph when used for tangent channelization.

GENERAL NOTES:

1. Final placement of signs and devices may be changed to fit field conditions as approved by the Resident.
2. Maintain same number of lanes for a shifting taper.
3. Shoulder taper allowed when a minimum of 10 feet can be open from centerline for lane.

Road Type	Distance Between Signs**		
	A	B	C
Urban 30 mph or less	100	100	100
Urban 35 mph and greater	350	350	350
Rural	500	500	500
Expressway / Urban Parkway	1000	1500	2640

**Distances are shown in feet.

SUGGESTED BUFFER ZONE LENGTHS

Speed (mph)	Length (feet)	Speed (mph)	Length (feet)
20	115	40	325
25	155	45	360
30	200	50	425
35	250	55	495

STANDARD DETAIL UPDATES

Standard Details and Standard Detail updates are available at:
<http://maine.gov/mdot/contractors/publications/standarddetail/>

<u>Detail #</u>	<u>Description</u>	<u>Revision Date</u>
501(02)	Pipe Pile Splice	3/05/2015
501(03)	H – Pile Splice	3/05/2015
504(07)	Diaphragm & Crossframe Notes	10/13/2015
505(01)	Shear Connectors	10/24/2016
507(13)	Steel Bridge Railing	6/03/2015
507(14)	Steel Bridge Railing	6/03/2015
507(31)	Barrier – Mounted Steel Bridge	8/06/2015
526(02)	Temporary Concrete Barrier	8/06/2015
652(06)	Construction Signs	10/24/2016
652(12)	Construction Traffic Control	10/24/2016
802(05)	Roadway Culvert End Slope Treatment	1/03/2017
504(10)	Drip Bar Details	9/06/2017

SUPPLEMENTAL SPECIFICATIONS
(Corrections, Additions, & Revisions to Standard Specifications - November 2014)

SECTION 101
CONTRACT INTERPRETATION

101.1 Abbreviations Revise the definition of AWP to “**American Wood Protection Association**”.

101.2 Definitions

Page 1-5 – Remove the definition of Bridge in its entirety and replace with:

“**Bridge** A structure that is erected over a depression or an obstruction, such as water, a highway or a railway, and has an opening measured along the centerline of the Roadway of more than 20 feet between: The faces of abutments; spring line of arches; extreme ends of openings of box culverts, pipes or pipe arches; or the extreme ends of openings for multiple box culverts, pipes or pipe arches.”

Page 1-12 – Remove the definition of Large Culvert in its entirety and replace with:

“**Large Culvert** Any structure not defined as a Culvert or Bridge that provides a drainage or non-drainage opening under the Roadway or Approaches to the Roadway, with an opening that is 5 feet but less than 10 feet.”

Remove the definition of Minor Span in its entirety and replace with:

“**Minor Span** Same definition as Bridge, except having an opening of between 10 feet and 20 feet, inclusive.”

SECTION 103
AWARD AND CONTRACTING

Amend this Section by adding the following:

“**103.1a Tie Bids** - In the case where two responsive bids from responsible bidders are equal monetarily, the Department shall determine the apparent low bidder by flipping a coin. The coin shall have sides clearly marked as heads and tails. The contractor whose first letter in their official company name that comes first in the alphabet shall be heads.

If there are three bids, each bidder will flip the coin and the bidder with the odd toss will be the winner. (i.e. if the results are two heads and a tails, the bidder who had tails is the winner). For a three way tie, bidders may flip their own coin or have the Contracts Engineer flip for them.

The coin flip will occur at the next bid opening by the Contracts and Specifications Engineer or a designee. The tied bidders may attend the coin flip in person or watch on the internet as they choose.”

In 103.3.2 Notice of Determination Revise this section by removing sections A – M and replacing with the following A - K:

(A) Default(s) or termination(s) on past or current Contracts.

(B) Failure on past or current Contracts to pay or settle all bills for labor, Materials or services;

to comply with directives of the Department, to fulfill warranty obligations, or to provide Closeout Documentation.

(C) "Below Standard" performance as determined from the Department's Contractor's Performance Rating process.

(D) Insufficient bonding capability or Inability of the Contractor to obtain or retain performance or Payment Bonds meeting MDOT requirements, or a pattern of unsupported Claims.

(E) Failure to accept an Award of a Contract made by the Department.

(F) Failure to provide information requested by the Department in a timely manner.

(G) Debarment, suspension or a denial of prequalification or 'award of contract' by any federal, State, or local governmental procurement agency or the Contractor's Agreement to refrain from Bidding as part of the settlement with any such agencies or any of the reasons contained in Section 102.02 of the "Rules Regarding Debarment of Contractors", Maine Department of Transportation Register 17-229, Chapter 102 (October 2, 1985).

(H) Failure to demonstrate ability to do work to the satisfaction and at the sole discretion of the Department.

(I) Number of personnel working directly for the Contractor with applicable knowledge and experience is significantly below industry standards.

(J) Safety Record, Environmental Record, Civil Rights or Equal Opportunity Record significantly below industry standards.

(K) Serious misconduct that the Department reasonably determines will substantially and adversely affect the cost, quality or timeliness of Work, or the safety of Workers or the public, any deceptive, evasive or fraudulent statements or omissions contained in the Application, made or omitted at any interview or hearing, or otherwise made to or omitted from the Department; or any other substantial deficiencies in experience or conduct that are clearly below industry standards and that clearly demonstrate in the sole discretion of the Department, that the Contractor is "Not Qualified".

SECTION 104 **GENERAL RIGHTS AND RESPONSIBILITIES**

This Section shall be amended by adding the following two sub-sections:

104.3.8.1 Electronic Payroll Submission On federally funded projects the prime contractor, all subcontractors, and lower-tier subcontractors will submit their certified payrolls electronically utilizing the Elations system. There is no charge to the contracting community for the use of this service. The submission of paper payrolls will not be allowed or accepted. Additional information can be found at <http://www.maine.gov/mdot/contractors/> under the “Bidder Info” go to “Electronic Payroll System.”

104.3.8.2 Payment Tracking On federally funded projects the prime contractor and all subcontractors and lower-tier subcontractors will track and confirm the delivery and receipt of all payments through the Elation System

104.4.10 Coordination of Road Closure / Bridge Closure / Bridge Width Restrictions

Revise the last sentence by adding a period after ‘Resident’; remove the “and” after Resident; and adding “**not covered by Pay Items**” between ‘costs’ and ‘will’. So that the last paragraph reads “**All Newspaper notices, radio announcements and any notifications will be subject to the approval of the Resident. All costs not covered by Pay Items will be considered incidental to the Contract.**”.

104.5.5 Prompt Payment of Subcontractors Add the following paragraph to this subsection:

C. Payment Tracking Federal Projects On federally funded projects, the prime contractor, subcontractors and lower-tier subcontractors will track and confirm the delivery and receipt of all payments through the Elation System. They will be responsible for entering all payments to all sub and lower tier contractors. MaineDOT will run a query monthly to ensure that contractors are complying and generate an e-mail to contractors who have not responded to confirm receipt of MaineDOT payment or contractor payment to lower tier subcontractors.

SECTION 105 **GENERAL SCOPE OF WORK**

105.2.5 Compliance with Health and Safety Laws Remove the second paragraph of this subsection in its entirety and replace with:

“For related provisions, see Sections 105.2.3 – Project Specific Emergency Planning, 105.3 – Traffic Control and Management and 105.4 – Maintenance of work.”

105.4.5 Special Detours Remove this subsection in its entirety and replace with:

“105.4.5 Maintenance of Existing Structures When a new Bridge or Minor Span is being installed on a new alignment and the existing structure is to remain in service, the Department will maintain the existing structure and the portions of the roadway required for maintaining traffic until such time that the new structure is opened to traffic and the existing structure is taken out of service. A similar situation exists when a new Bridge or Minor Span is being installed on the same alignment as the existing structure, requiring a temporary detour to be installed by the Contractor per Section 510, Special Detours, prior to removal of the existing structure. In this case, the Department will maintain the existing structure and the portions of the existing roadway required for maintaining traffic until such time that either the temporary detour is opened to traffic or the Contractor begins any work on the existing structure, including, but not limited to, repairs, modifications, moving, demolition or removal. In either case, once the new structure or temporary detour is opened to traffic, or the Contractor begins any work on the existing structure, the Contractor shall be solely responsible for all maintenance of the existing structure and the portions of the existing approaches that lie outside the new roadway or the temporary detour, respectively. This specification is not intended to supersede Standard Specification Section 104.3.11, Responsibility for Property of Others.”

105.6.2.4 Department Verification Add the following to the end of the first sentence: “or other approved method, such as reference staking, to allow the Department to independently verify the accuracy of the work, as approved by the Department.”

SECTION 106 **QUALITY**

106.3.4 Storage Revise this Section by adding the following sentence after the first sentence: “Materials shall not be stored under or in close proximity to Highway Structures unless the Contractor receives written permission from the Resident.”

106.4.1 General - In the first sentence, remove “When required by Special Provision,” and replace with “When required elsewhere in the Contract,”

Revise Subsection C by replacing the last sentence with the following:

Approval of both standard and project specific QCPs shall be as outlined in paragraph B above, with the exception that the initial 14 day review period for standard plans will begin on March 1, and that the supplemental project specific QCP for the project shall be submitted a minimum of 14 days prior to any related work being performed with an initial review period of 7 days.

SECTION 108
PAYMENT

108.3 Retainage - Remove the paragraph beginning with “The Contractor may withdraw...” in its entirety.

108.4.1 Price Adjustment for Hot Mix Asphalt:

Remove this section in its entirety and replace with the following

For all contracts with hot mix asphalt in excess of 500 tons total, a price adjustment for performance graded binder will be made for the following pay items:

Item 403.102	Hot Mix Asphalt – Special Areas
Item 403.206	Hot Mix Asphalt - 25 mm
Item 403.207	Hot Mix Asphalt - 19 mm
Item 403.2071	Hot Mix Asphalt - 19 mm (Polymer Modified)
Item 403.2072	Hot Mix Asphalt - 19 mm (Asphalt Rich Base)
Item 403.208	Hot Mix Asphalt - 12.5 mm
Item 403.2081	Hot Mix Asphalt - 12.5 mm (Polymer Modified)
Item 403.209	Hot Mix Asphalt - 9.5 mm (sidewalks, drives, & incidentals)
Item 403.210	Hot Mix Asphalt - 9.5 mm
Item 403.2101	Hot Mix Asphalt - 9.5 mm (Polymer Modified)
Item 403.2102	Hot Mix Asphalt - 9.5 mm (Asphalt Rich Base)
Item 403.2104	Hot Mix Asphalt - 9.5 mm (Thin Lift Surface Treatment)
Item 403.21041	Hot Mix Asphalt - 9.5 mm (Polymer Modified Thin Lift Surface Treatment)
Item 403.211	Hot Mix Asphalt – Shim
Item 403.2111	Hot Mix Asphalt – Shim (Polymer Modified)
Item 403.212	Hot Mix Asphalt - 4.75 mm (Shim)
Item 403.213	Hot Mix Asphalt - 12.5 mm (base and intermediate course)
Item 403.2131	Hot Mix Asphalt - 12.5 mm (base and intermediate course Polymer Modified)
Item 403.2132	Hot Mix Asphalt - 12.5 mm (Asphalt Rich Base and intermediate course)
Item 403.214	Hot Mix Asphalt - 4.75 mm (Surface)
Item 403.235	Hot Mix Asphalt (High Performance Rubberized HMA)
Item 403.301	Hot Mix Asphalt (Asphalt Rubber Gap-Graded)
Item 404.70	Colored Hot Mix Asphalt – 9.5mm (Surface)
Item 404.72	Colored Hot Mix Asphalt – 9.5mm (Islands, sidewalks, & incidentals)
Item 461.13	Light Capital Pavement
Item 461.210	9.5 mm HMA - Paver Placed Surface
Item 462.30	Ultra-Thin Bonded Wearing Course
Item 462.301	Polymer Modified Ultra-Thin Bonded Wearing Course

Price adjustments will be based on the variance in costs for the performance graded binder component of hot mix asphalt. They will be determined as follows:

The quantity of hot mix asphalt for each pay item will be multiplied by the performance graded binder percentages given in the table below times the difference in price between the base price and the period price of asphalt cement. Adjustments will be made upward or downward, as prices increase or decrease.

Item 403.102-6.2%
Item 403.206-4.8%
Item 403.207-5.2%
Item 403.2071-5.2%
Item 403.2072-5.8%
Item 403.208-5.6%
Item 403.2081-5.6%
Item 403.209-6.2%
Item 403.210-6.2%
Item 403.2101-6.2%
Item 403.2102-6.8%
Item 403.2104-6.2%
Item 403.21041-6.2%
Item 403.211-6.2%
Item 403.2111-6.2%
Item 403.212-6.8%
Item 403.213-5.6%
Item 403.2131-5.6%
Item 403.2132-6.2%
Item 403.214-6.8%
Item 403.235-5.5%
Item 403.301-6.2%
Item 404.70-6.2%
Item 404.72-6.2%
Item 461.13-6.5%
Item 461.210 - 6.4%
Item 462.30-0.0021 tons/SY
Item 462.301-0.0021 tons/SY

Hot Mix Asphalt: The quantity of hot mix asphalt will be determined from the quantity shown on the progress estimate for each pay period.

Base Price: The base price of performance graded binder to be used is the price per standard ton current with the bid opening date. This price is determined by using the average New England Selling Price (Excluding the Connecticut market area), as listed in the Asphalt Weekly Monitor.

Period Price: The period price of performance graded binder will be determined by the Department by using the average New England Selling Price (Excluding the Connecticut market area), listed in the Asphalt Weekly Monitor current with the paving date. The maximum Period Price for paving after the adjusted Contract Completion Date will be the Period Price on the adjusted Contract Completion Date.

SECTION 109 **CHANGES**

109.5.1 Definitions - Types of Delays

Delete Paragraph 'A' in its entirety and replace with:

"A. Excusable Delay Except as expressly provided otherwise by this Contract, an "Excusable Delay" is a Delay to the Critical Path that is directly and solely caused by (1) a weather related Event of such an unusually severe nature that a Federal Emergency Disaster is declared. The Contractor will only be entitled to an adjustment of time if the Project falls within the geographic boundaries prescribed under the disaster declaration. or (2) a flooding event at the effected location of the Project that results in a Q25 headwater elevation, or greater, but less than a Q50 headwater elevation. Theoretical headwater elevations will be determined by the Department; actual headwater elevations will be determined by the Contractor and verified by the Department or (3) An Uncontrollable Event."

APPENDIX A TO DIVISION 100

Remove Section D in its entirety as this is now covered in Section 105.10 EQUAL OPPORTUNITY AND CIVIL RIGHTS.

SECTION 203 **EXCAVATION AND EMBANKMENT**

203.02 Materials

At the bottom of page 2-12, add as the first item in the list:

Crushed Stone, ¾ inch 703.13

203.042 Rock Excavation and Blasting

On page 2-16, add the word "No" to the third sentence in Section 5 Submittals, Subsection V, 1 so that it reads:

"No blasting products will be allowed on the job site if the date codes are missing."

SECTION 304
AGGREGATE BASE AND SUBBASE COURSE

304.02 – Aggregate Add the following sentence before the sentence starting with “When designated on the plans...”: **“Aggregate Base Course – Type C will be capped with 2” of millings or Untreated Aggregate Surface Course – Type B. Payment for this material will be made under 304.16”**

Revise the sentence beginning “When designated on the Plans, Type E...” by removing “When designated on the Plans,” so it reads **“Type E subbase may be used 9 inches below and lower beneath the pavement.”**

SECTION 307
FULL DEPTH RECYCLED PAVEMENT

Remove this Section in its entirety and replace with:

SECTION 307
FULL DEPTH RECYCLING
(UNTREATED OR TREATED WITH EMULSIFIED ASPHALT STABILIZER)

307.01 Description This work shall consist of pulverizing a portion of the existing roadway structure into a homogenous mass, adding an emulsified asphalt stabilizer (if required) to the depth of the pulverized material specified in the contract, placing and compacting this material to the lines, grades, and dimensions shown on the plans or established by the Resident.

MATERIALS

307.02 Pulverized Material Pulverized material shall consist of the existing asphalt pavement layers and one inch or more as specified of the underlying gravel, pulverized and blended into a homogenous mass. Pulverized material will be processed to 100% passing a 2 inch square mesh sieve.

307.021 New Aggregate and Additional Recycled Material New aggregate, if required by the contract, shall meet the requirements of Subsection 703.10 - Aggregate for Untreated Surface Course and Leveling Course, Type A. Aggregate Subbase Course Gravel Type D processed to 100 percent passing a 2 inch square mesh sieve and meeting the requirements of 703.06 – Aggregate for Base and Subbase may be used in areas requiring depths greater than 2 inches. New aggregate, will be measured and paid for under the appropriate item.

Recycled material, if required, shall consist of salvaged asphalt material from the project or from off-site stockpiles that has been processed before use to 100 percent passing a 2 inch square mesh sieve. Recycled material shall be conditionally accepted at the source by the Resident. It shall be free of winter sand, granular fill, construction debris, or other materials not generally considered asphalt pavement.

Recycled material generated and salvaged from the project shall be used within the roadway limits to the extent it is available as described in 307.09. No additional payment will be made for material salvaged from the project.

Recycled material supplied from off-site stockpiles shall be paid for as described in the contract, or by contract modification.

307.022 Emulsified Asphalt Stabilizer. If required, the emulsified asphalt stabilizer shall be grade MS-2, MS-4, SS-1, or CSS-1 meeting the requirements of Subsection 702.04 Emulsified Asphalt.

307.023 Water Water shall be clean and free from deleterious concentrations of acids, alkalis, salts or other organic or chemical substances.

307.024 Portland Cement If required, Portland Cement shall be Type I or II meeting the requirements of AASHTO M85.

307.025 Hydrated Lime If required, Hydrated Lime shall meet the requirements of AASHTO M216.

EQUIPMENT

307.03 Pulverizer The pulverizer shall be a self-propelled machine, specifically manufactured for full-depth recycling work and capable of reducing the required existing materials to a size that will pass a 2 inch square mesh sieve. The machine shall be equipped with standard automatic depth controls and must maintain a consistent cutting depth and width. The machine also shall be equipped with a gauge to show depth of material being processed.

307.04 Liquid Mixer Unit or Distributor. If treatment of the recycled layer with emulsified asphalt is required by the contract, a liquid mixing unit or distributor shall be used to introduce the emulsified asphalt stabilizer into the pulverized material. The mixing unit shall contain a liquid distribution and mixing system which has been specifically manufactured for full-depth recycling work, capable of mixing the pulverized material with an evenly metered distribution of emulsified asphalt into a homogeneous mixture, to the depth and width required.

The mixing unit shall be designed, equipped, maintained, and operated so that emulsified asphalt stabilizer at constant temperature may be applied uniformly on variable widths of pulverized material up to 6 feet at readily determined and controlled rates from 0.01 to 1.06 gal/yd² with uniform pressure and with an allowable variation from any specified rate not to exceed 0.01 gal/ yd². Mixing units shall include a tachometer, pressure gages, and accurate volume measuring devices or a calibrated tank and a thermometer for measuring temperatures of tank contents.

307.041 Cement or Lime Spreader If required by the contract, spreading of the Portland Cement or Hydrated Lime shall be done with a spreader truck designed to spread dry particulate (such as Portland Cement or Lime) or other approved means to insure a uniform distribution across the roadway and minimize fugitive dust. Pneumatic application, including through a slotted pipe, will not be permitted. Other systems that have been developed include fog systems, vacuum systems, etc. Slurry applications may also be accepted. The Department reserves the right to accept or reject the method of spreading cement. The Contractor shall provide a method for verifying that the correct amount of cement is being applied.

307.05 Placement Equipment Placement of the Full Depth recycled material to the required slope and grade shall be done with an approved highway grader or by another method approved by the Resident.

307.06 Rollers The full depth recycled material shall be rolled with a vibratory pad foot roller, a vibratory steel drum soil compactor and a pneumatic tire roller. The pad foot roller drum shall have a minimum of 112 tamping feet 3 inches in height, a minimum contact area per foot of 17 inch², and a minimum width of 84 inches. The vibratory steel drum roller shall have a minimum 84 inch width single drum. The pneumatic tire roller shall meet the requirements of Section 401.10 and the minimum allowable tire pressure shall be 85 psi.

MIX DESIGN

If treatment of the recycled layer with emulsified asphalt is required by the contract, the Department will supply a mix design for the emulsified asphalt stabilized material based on test results from pavement and soil analysis taken to the design depth. The Department will provide the following information prior to construction:

1. Percent of emulsified asphalt to be used.
2. Quantity of lime or cement to be added.
3. Optimum moisture content for proper compaction.
4. Additional aggregate (if required).

After a test strip has been completed or as the work progresses, it may be necessary for the Resident to make necessary adjustments to the mix design. Changes to compensation will be in accordance with the Mix Design Special Provision.

CONSTRUCTION REQUIREMENTS

307.06 Pulverizing The entire depth of existing pavement shall be pulverized together with 1 inch or more of the underlying gravel into a homogenous mass. All pulverizing shall be done with equipment that will provide a homogenous mass of pulverized material, processed in-place, which will pass a 2 inch square mesh sieve.

307.07 Weather Limitations Full depth recycled work shall be performed when;

- A. Recycling operations will be allowed between May 15th and September 15th inclusive in Zone 1 - Areas north of US Route 2 from Gilead to Bangor and north of Route 9 from Bangor to Calais.
- B. The atmospheric temperature, as determined by an approved thermometer placed in the shade at the recycling location, is 50°F and rising.
- C. When there is no standing water on the surface.
- D. During generally dry conditions, or when weather conditions are such that proper pulverizing, mixing, grading, finishing and curing can be obtained using proper procedures, and when compaction can be accomplished as determined by the Resident.
- E. When the surface is not frozen and when overnight temperatures are expected to be above 32°F.
- F. Wind conditions are such that the spreading of lime or cement on the roadway ahead of the recycling machine will not adversely affect the operation.

307.08 Surface Tolerance The complete surface of the Full Depth Recycled course shall be shaped and maintained to a tolerance, above or below the required cross sectional shape, of $\frac{3}{8}$ inch.

307.09 Full Depth Recycling Procedure New aggregate or recycled material meeting the requirements of Section 307.021 - New Aggregate and Additional Recycled Material, shall be added as necessary to restore cross-slope and/or grade before pulverizing. Locations will be shown on the plans or described in the construction notes. The Resident may add other locations while construction of the project is in progress. The Contractor will use recycled material to the extent it is available, in lieu of new aggregate. The material shall then be pulverized, processed, and blended into a homogeneous mass passing a 2 inch square mesh sieve. Material found not pulverized down to a 2 inch size will be required to be reprocessed by the recycler with successive passes until approved by the Resident.

Should the Contractor be required to add new aggregate or recycled material to restore cross-slope and/or grade after the initial pulverizing process, those areas will require re-processing to blend into a homogenous mass passing a 2 in square mesh sieve.

Sufficient water shall be added during the recycling process to maintain optimum moisture for compaction.

The resultant material from the initial pulverizing processes shall be graded and compacted to the cross-slope and profile shown on the plans or as directed by the Resident. The Contractor will also be responsible for re-establishing the existing profile grade. The completed surface of the full depth recycled course shall be shaped and maintained to a tolerance, above or below the required cross sectional shape, of $\frac{3}{8}$ inch. Areas not meeting this tolerance will be repaired as described in Section 307.091. The initial pulverizing process density requirements will be the same as Section 307.101 unless otherwise directed by the Resident.

Additives, if required, shall be introduced following completion of the initial pulverizing and blending process. Emulsified asphalt stabilizer shall be incorporated into the top of the processed material as specified in section 307.04 to the depth specified in the contract by use of the liquid mixer unit or a distributor, at the rate specified in the mix design. The emulsified asphalt shall then be uniformly blended into a homogeneous mass until an apparent uniform distribution has occurred. The rate of application may be adjusted as necessary by the Resident. Cement or lime shall be introduced as described in section 307.041. The resultant material shall be graded and compacted to the cross-slope and profile shown on the plans or as directed by the Resident. The Contractor will also be responsible for re-establishing the existing profile grade.

After final compaction, the roadway surface shall be treated with a light application of water, and rolled with pneumatic-tired rollers to create a close-knit texture. The finished layer shall be free from:

- A. Surface laminations.
- B. Segregation of fine and coarse aggregate.
- C. Corrugations, centerline differential, potholes, or any other defects that may adversely affect the performance of the layer, or any layers to be placed upon it.

The Contractor shall protect and maintain the recycled layer until a lift of pavement is applied. Any damage or defects in the layer shall be repaired immediately. An even and uniform surface shall be maintained. The recycled surface shall be swept prior to hot mix asphalt overlay placement.

307.091 Repairs Repairs and maintenance of the recycled layers, resulting from damage caused by traffic, weather or environmental conditions, or resulting from damage caused by the Contractor's operations or equipment, shall be completed at no additional cost to the Department.

For recycled layers stabilized with emulsified asphalt, low areas will be repaired using a hot mix asphalt shim. Areas up to 1 inch high can be repaired by milling or shimming with hot mix asphalt. Areas greater than 1 inch high will be repaired using a hot mix asphalt shim. All repair work will be done with the Resident's approval at the Contractor's expense.

TESTING REQUIREMENTS

307.10 Quality Control The Contractor shall operate in accordance with the approved Quality Control Plan (QCP) to assure a product meeting the contract requirements. The QCP shall meet the requirements of Section 106.4 - Quality Control and this Section. The Contractor shall not begin recycling operations until the Department approves the QCP in writing. Prior to performing any recycling process, the Department and the Contractor shall hold a Pre-recycle conference to discuss the recycling schedule, type and amount of equipment to be used, sequence of operations, and traffic control. A copy of the QC random numbers to be used on the project shall be provided to the Resident. All field supervisors including the responsible onsite recycling process supervisor shall attend this meeting.

The QCP shall address any items that affect the quality of the Recycling Process including, but not limited to, the following:

- A. Sources for all materials, including New Aggregate and Additional Recycled Material.
- B. Make and type of rollers including weight, weight per inch of steel wheels, and average contact pressure for pneumatic tired rollers.
- C. Testing Plan.
- D. Recycling operations including recycling speed, methods to ensure that segregation is minimized, grading and compacting operations.
- E. Methods for protecting the finished product from damage and procedures for any necessary corrective action.
- F. Method of grade checks.
- G. Examples of Quality Control forms.
- H. Name, responsibilities, and qualifications of the Responsible onsite Recycling Supervisor experienced and knowledgeable with the process.
- I. A note that all testing will be done in accordance with AASHTO and MDOT/ACM procedures.

The Project Superintendent shall be named in the QCP, and the responsibilities for successful implementation of the QCP shall be outlined.

The Contractor shall sample, test, and evaluate the full depth reclamation process in accordance with the following minimum frequencies:

MINIMUM QUALITY CONTROL FREQUENCIES

Test or Action	Frequency	Test Method
Density	1 per 1000 feet / lane	AASHTO T 310
Air Temperature	4 per day at even intervals	
Surface Temperature	At the beginning and end of each days operation	
Yield of all materials (Daily yield, yield since last test, and total project yield.)	1 per 1000 ft/lane	

The Department may view any QC test and request a QC test at any time. The Contractor shall submit all QC test reports and summaries in writing, signed by the appropriate technician, to the Department’s onsite representative by 1:00 P.M. on the next working day, except when otherwise noted in the QCP due to local restrictions. The Contractor shall make all test results, including randomly sampled densities, available to the Department onsite.

The Contractor shall cease recycling operations whenever one of the following occurs:

- A. The Contractor fails to follow the approved QCP.
- B. The Contractor fails to achieve 98 percent density after corrective action has been taken.
- C. The finished product is visually defective, as determined by the Resident.
- D. The computed yield differs from the mix design by 10 percent or more.

Recycling operations shall not resume until the Department approves the corrective action to be taken.

307.101 Test Strip The contractor shall assemble all items of equipment for the recycling operation on the first day of the recycling work. The Contractor shall construct a test strip for the project at a location approved by the Resident. The Responsible onsite Recycling Supervisor will work with Department personnel to determine the suitability of the mixed material, moisture control within the mixed material, and compaction and surface finish. The test strip section is required to:

- A. Demonstrate that the equipment and processes can produce recycled layers to meet the requirements specified in these special provisions.
- B. Determine the effect on the gradation of the recycled material by varying the forward speed of the recycling machine and the rotation rate of the milling drum.

- C. Determine the optimum moisture necessary to achieve proper compaction of the recycled layer.
- D. Determine the sequence and manner of rolling necessary to obtain the compaction requirements and establish a target density. The Contractor and the Department will both conduct testing with their respective gauges at this time.

The test strip shall be at least 300 feet in length of a full lane-width (or a half-road width). Full recycling production will not start until a passing test strip has been accomplished. If a test strip fails to meet the requirements of this specification, the Contractor will be required to repair or replace the test strip to the satisfaction of the Resident. Any repairs, replacement, or duplication of the test strip will be at the Contractor's expense.

After the test strip has been pulverized, and the roadway brought to proper shape, the Contractor shall add water until it is determined that optimum moisture has been obtained. The test strip shall then be rolled using the specified compaction equipment as directed until the density readings show an increase in dry density of less than 1 pcf for the final four roller passes of each roller. The Contractor and Department will each determine a target density using their respective gauges by performing several additional density tests and averaging them. The average of these tests will be used as the target density of the recycled material for QC and Acceptance purposes.

Following completion of the test strip, compaction of the material shall continue until a density of not less than 98 percent of the test strip target density has been achieved for the full width and depth of the layer. During the construction and compaction of the Full Depth Recycled base, should three consecutive Acceptance test results for density fail to meet a minimum of 95 percent of the target density, or exceed 102 percent of target density, a new test strip shall be constructed.

ACCEPTANCE TEST FREQUENCY

Property	Frequency	Test Method
In-place Density	1 per 2000 ft / lane	AASHTO T 310

308.102 Curing. No new pavement shall be placed on the full depth recycled pavement until curing has reduced the moisture content to 1 percent or less by total weight of the mixture, or a curing period of 4 days has elapsed, whichever comes first.

307.11 Method of Measurement Full Depth Recycled Pavement (Untreated or Treated with Emulsified Asphalt Stabilizer) will be measured by the square yard.

307.12 Basis of Payment The accepted quantity of Full Depth Recycled Asphalt Pavement (Untreated or Treated with Emulsified Asphalt Stabilizer) will be paid for at the contract unit price per square yard, complete in-place which price will be full compensation for furnishing all equipment, materials and labor for pulverizing, blending, placing, grading, compacting, and for all incidentals necessary to complete the work.

The addition of materials to restore profile grade and/or cross-slope in areas shown on the plans or described in the construction notes will be paid separately under designated pay items within the contract. No additional payment will be made for materials salvaged from the project.

Payments will be made under:

<u>Pay Item</u>	<u>Pay Unit</u>
307.331 Full Depth Recycled Pavement (Untreated)	Square Yard
307.332 Full Depth Recycled Pavement (with Emulsified Asphalt Stabilizer) 5 in. depth	Square Yard
307.333 Full Depth Recycled Pavement (with Emulsified Asphalt Stabilizer) 6 in. depth	Square Yard

SECTION 411
UNTREATED AGGREGATE SURFACE COURSE

411.02 – Aggregate Add the following to the end of the first sentence: “- Type A”

SECTION 501
FOUNDATION PILES

501.05 – Method of Measurement

- b. Piles Furnished – After the second sentence, add the sentence “**Measurement will not include any pile tips**”.
- c. Piles in Place – Add the sentence to the end of the second paragraph, “**Measurement will include the pile tips**”.
- d. Pile Tips – Add the words “**on the Pile**” to the end of the sentence.

SECTION 502
STRUCTURAL CONCRETE

502.05 Composition and Proportioning

Replace Table 1 with

TABLE 1

Concrete CLASS	Minimum Compressive Strength (PSI)	Permeability as indicated by Surface Resistivity (KOhm-cm)	Entrained Air (%)		Notes
			LSL	USL	
S	3,000	LSL	LSL	USL	4,5
		N/A	N/A	N/A	
A	4,000	14	6.0	9.0	1,4,5
P	-----	-----	5.5	7.5	1,2,3,4
LP	5,000	17	6.0	9.0	1,4,5
Fill	3,000	N/A	6.0	9.0	4,5

In the list of information submitted by the contractor for a mix design:

Item J Replace “Target Coulomb Value.” with “Target KOhm-cm Value.”

Note #1 - Remove, “...Standard Specification Section 711.05, Protective Coating for Concrete Surfaces, and per the manufacturer’s recommendations, at no additional cost to the Department.” and replace with, “...Standard Specification Section 515, Protective Coating for Concrete Surfaces, at no additional cost to the Department.”

502.1703 Acceptance Methods A and B

In the paragraph that starts with “The Department will take Acceptance...” Remove the word chloride from chloride permeability in the last sentence.

Replace the paragraph starting with “Rapid Chloride Permeability specimens...” With the following:

“Surface Resistivity specimens will be tested by the Department in accordance with AASHTO TP-95 at an age \geq 56 days. Four 4 inch x 8 inch cylinders will be cast per subplot placed. The average of three concrete specimens per subplot will constitute a test result and this average will be used to determine the permeability for pay adjustment computations.”

502.1706 Acceptance Method C

Remove in its entirety and Replace with:

502.1706 Acceptance Method C The Department will determine the acceptability of the concrete through Acceptance testing. Acceptance tests will include compressive strength, air content and permeability. Method C concrete not meeting the requirements listed in Table 1 shall be removed and replaced at no cost to the Department. At the Department’s sole discretion, material not meeting requirements may be left in place and paid for at a reduced price as described in Section 502.195.

502.1707 Resolution of Disputed Acceptance Test Results
Section B

Remove “Rapid Chloride” from the section heading.
In paragraph 4 replace T-277 with TP-95

502.192 Pay Adjustment for Chloride Permeability

Remove “Chloride” from the heading and from the first sentence.

Replace the sentence that starts with “values greater than...” and replace with “values less than 10 KOhms-cm for Class A concrete or 11 KOhms-cm for Class LP concrete shall be subject to rejection and replacement, at no additional cost to the Department.”

502.194 Pay Adjustments for Compressive Strength, Chloride Permeability and Air Content, Methods A and B

Remove the word “Chloride” from the section heading and from the equation for CPF.

502.195 Pay Adjustment Method C

In Table 6: Method C Pay Reductions (page 5-53)
Under “Entrained Air” for “Class Fill”, in the first line,
change from “< 4.0 (Removal)” to “< 4.5 (Removal)”

In Table 6: Method C PAY REDUCTIONS, revise the Chloride Permeability section by removing it in its entirety and replacing it with:

Surface Resistivity {Permeability in Kohm-cms and Pay Reduction per CY}			
15-16 (\$50)	13 (\$25)	N/A	N/A
13-14 (\$75)	12(\$50)	N/A	N/A
12 (\$100)	11 (\$75)	N/A	N/A
11 (\$125)	10 (\$100)	N/A	N/A
< 11 (Removal)	< 10 (Removal)	N/A	N/A

SECTION 503 **REINFORCING STEEL**

503.06 Placing and Fastening Revise this Subsection by removing, in its entirety, the paragraph which begins, “Stainless steel reinforcement shall not be tied to any other type of reinforcement.....”

SECTION 504 **STRUCTURAL STEEL**

504.26 Welding Remove the second paragraph beginning with “The range of heat....” in its entirety.

504.29 Welding ASTM A 709 HPS 70W Steel. Remove the third paragraph beginning with “Make Weld runoff tabs...” in its entirety.

SECTION 510 **SPECIAL DETOURS**

510.032 Geometric and Approach Design a. Horizontal alignment
The third paragraph of this section is revised to read as follows:

“The roadway width shall be increased on curved portions of the Special Detour to account for the off tracking characteristics of WB-62 vehicle in accordance with **the AASHTO publication A Policy On Geometric Design of Highways and Streets (the Green Book), chapter 3 table entitled Design Widths of Pavements for Turning Roadways.**”

SECTION 527 **ENERGY ABSORBING UNIT**

527.02 Materials This section is revised to read as follows.

527.02 Materials Work Zone Crash Cushions must comply with NCHRP Report 350. Work Zone Crash Cushions shall be selected from MaineDOT’s Qualified Products List of Crash Cushions / Impact Attenuators, or an approved equal.

SECTION 534 **PRECAST STRUCTURAL CONCRETE**

534.14 Process Control Test Cylinders
Revise this subsection to read:

“**534.14 Acceptance and Quality Control Testing of Concrete Refer to Section 712.061.**”

SECTION 535 **PRECAST, PRESTRESSED CONCRETE SUPERSTRUCTURE**

Section 535.08 – Quality Assurance

Revise the second paragraph to read:

“The QAI will perform acceptance sampling and testing and will witness or review documentation, workmanship and testing to assure the Work is being performed in accordance with the Contract Documents.”

Section 535.15 - Process Control Test Cylinders

Revise the first paragraph to read:

“535.15 Acceptance and Quality Control Testing of Concrete Acceptance of structural precast/prestressed units, for each day’s production, will be determined by the Department, based on compliance with this specification and satisfactory concrete testing results. At least once per week, the QAI will make 2 concrete cylinders (6 cylinders when the Contract includes permeability requirements) for use by the Department; cylinders shall be standard cured in accordance with AASHTO T23 (ASTM C31). The QAI will perform entrained air content and slump flow testing, determine water-cement ratio and determine temperature of the sampled concrete at the time of cylinder casting. All testing equipment required by the QAI to perform this testing shall be provided in accordance with Standard Specification Section 502.041, Testing Equipment. In addition, the Contractor shall provide a slump cone meeting the requirements of AASHTO T 119. Providing and maintaining testing and curing equipment shall be considered incidental to the work and no additional payment will be made.”

Insert the following as the second paragraph of Section 535.15:

“Quality Control concrete test cylinders shall be made for each day’s cast and each form bed used. Cylinders tested to determine strand release strength and design strength shall be field cured in accordance with AASHTO T23 (ASTM C31). 28 day cylinders shall be standard cured. Record unit identification, entrained air content, water-cement ratio, slump flow and temperature of the sampled concrete at the time of cylinder casting.”

SECTION 604 **MANHOLES, INLETS CATCH BASINS**

604.04 Adjusting Catch Basins and Manholes,

Add the following paragraph to the end of 604.04 b:

The Department will allow the use of metal ring inserts set into the manhole top frame or composite risers placed beneath the manhole frame to adjust manhole slope and grade for paving projects. The use of metal ring inserts shall be in accordance with 604.04 d. Ring Insert Requirements. The use of composite risers shall be in accordance with 604.04 e. Composite Riser Requirements.

Add the following paragraph after the first paragraph of 604.04 c:

The Department will allow the use of metal ring inserts set into the manhole top frame or composite risers placed beneath the manhole frame to adjust manhole slope and grade for paving projects. The use of metal ring inserts shall be in accordance with 604.04 d. Ring Insert Requirements. The use of composite risers shall be in accordance with 604.04 e. Composite Riser Requirements.

Add the following sections to 604.04:

d. Ring Insert Requirements Ring inserts to adjust manhole top frame slope and grade will be allowed in accordance with the following requirements:

1) Materials

- i. All ring inserts must be made of iron. *Multiple ring inserts will not be allowed.* The single ring insert may be any height up to a maximum of 2 inches tall.**
- ii. Ring inserts shall not be welded to the manhole frame to prevent brittle failure of the cast iron frame.**
- iii. Ring inserts shall be fastened to the manhole frame using liquid steel-filled epoxy such as Loctite Fixmaster Steel Liquid or equivalent. The epoxy shall be installed in accordance with the manufacturer's recommendations.**

2) Where Ring Inserts May/May Not Be Used

- i. MaineDOT will allow the use of a single manhole ring insert to raise manholes on state and state-aid highways.**
- ii. *Manhole ring inserts may not be used along state and state-aid highway sections where the speed limit is 40 miles per hour or more.* The standard brick and mortar or flat composite risers beneath the manhole frame must be used at these locations.**

3) Construction Requirements For The Use of Iron Manhole Ring Inserts

- i. Wherever iron ring inserts are used to raise manhole top elevations, the rings shall be fastened to the existing manhole frame using liquid steel-filled epoxy. The liquid steel-filled epoxy shall be placed evenly around the entire manhole frame before placing the ring insert. *Unbonded ring inserts will not be allowed.* If the manufacturer's recommended construction practices result in loose or unacceptable manhole cover restraint, standard brick and mortar or flat composite risers beneath the manhole frame must be used at these locations.

e. Composite Riser Requirements Flat or beveled, doughnut-shaped, composite risers placed beneath the manhole frame to adjust slope and grade are allowed. The composite riser shall be fastened to both the top of the concrete cone and bottom of the manhole frame with the manufacturer's recommended epoxy. Composite risers may be used at all locations on state and state-aid highways under any legal speed limit without restriction.

SECTION 606 **GUARDRAIL**

606.09 Basis of Payment Amend the first sentence of the eighth paragraph of this subsection by removing the word "meter" and replace it with "linear foot".

SECTION 608 **SIDEWALKS**

608.021 Sidewalk Materials Revise this section by removing the second paragraph which begins with "Portland cement concrete shall..." in its entirety and replace with "**Portland cement concrete shall be Class A and meet the requirements of Section 502, Structural Concrete.**"

SECTION 609 **CURB**

609.03 Vertical Stone Curb, Terminal Section and Transition Sections and Portland Cement Concrete Curb, Terminal Sections and Transition Sections

Amend this section by adding the following paragraph to the end of it:

"The Contractor may elect to substitute concrete to backfill Stone Curbing or Stone Edging at their option. If the concrete backfill option is elected, the following is added to Standard Specification 609 – Curb"

609.02 Materials Amend this section by adding the following to it:

Portland cement and Portland Pozzolan Cement	701.01
Water	701.02
Fine Aggregate for Concrete	703.01
Coarse Aggregate for Concrete	703.02

The Contractor shall submit a concrete mix design for the Portland Cement Concrete to the Resident, with a minimum designed compressive strength of 4000 psi Class A concrete.

609.10 Basis of Payment Revise by changing the fifth paragraph which begins with “There will be no separate payment...” this section by removing the word “cement” and replacing it with “**concrete fill, mortar**”.

SECTION 619 **MULCH**

619.07 Basis of Payment Amend this section by adding the words “; **Bark Mulch and Erosion Control Mix will be paid for by the Cubic Yard;**” into the first sentence so that it reads:

“The accepted areas mulched will be paid for at the contract price per unit; **Bark Mulch and Erosion Control Mix will be paid for by the Cubic Yard;** which shall be full compensation for furnishing and spreading the hay or straw and mulch binder, cellulose fiber mulch, bark mulch or erosion control mix.

Revise the second sentence by removing “ **for pay item 619.1201**” So that it reads:

“When Mulch is measured in Bales, each bale will be paid for at 60% of the contract price per Unit”.

Revise this section by removing all pay items and replace them with the following:

619.12 Mulch	Unit
619.13 Bark Mulch	Cubic Yard
619.14 Erosion Control Mix	Cubic Yard

SECTION 621 **LANDSCAPING**

621.0002 Materials - General

In the list of items change “Organic Humus” to “**Humus**”.

621.0019 Plant Pits and Beds

c Class A Planting

In the third paragraph beginning with “ The plant pit...” change “½ inch” to “**1 inch**”

SECTION 626
**FOUNDATIONS, CONDUIT AND JUNCTION BOXES FOR HIGHWAY
SIGNING, LIGHTING AND SIGNALS**

626.02 General Amend the Material list by adding the following to the list:

Gravel Borrow	703.20
---------------	--------

Revise the Material List by removing:

Prewired Conduit	715.04
Metallic Junction and Fuse Box	715.05

626.021 Miscellaneous Material Amend this section by adding the following to the end of it:

“All concrete for concrete encasement of conduit shall be Fill Class concrete in accordance with the applicable requirements of Section 502 – Structural Concrete.”

Amend the third paragraph that begins with “If grouting is necessary...” by adding “**included on the Qualified Product List and**” after the word “material”.

626.03 General Amend this section by adding the following section to the end of it

“626.0301 Electrical Supply Lines and Service Connections The following requirements shall apply to Electric Supply Lines and Service Connections feeding traffic signalization equipment control boxes and lighting breaker boxes.

Whenever possible, the meter and breaker panel feeding traffic signal control boxes or lighting control boxes shall be constructed within 30 feet of the service drop pole.

All service connections to MaineDOT traffic signal control boxes or lighting breaker boxes constructed in trenches shall be in steel conduit or concrete encased PVC conduit.

Where trenchless technologies are employed to install the service connection conduit, Schedule 120 PVC conduit shall be used for the trenchless bore section of conduit. In addition, concrete encasement shall be used for any conduit placed in trench sections more than 10 feet before or after the limits of the trenchless bore conduit.

The construction practices described above shall be used for service connections up to a maximum of 600 feet. There may be rare exceptional cases where the service connection must exceed 600 feet. In these cases, the power companies may require primary power be run over 600 feet for the purpose of power consumption and dependable service. These cases will be evaluated on a case-by-case basis for alternate power feed methods and/or the need for steel or concrete encased conduit.”

626.031 Conduit Revise this section by removing the second paragraph which begins with “Trenches for conduits...” and replace it with the following:

“Trenches for conduits shall be excavated to a width that will permit proper installation of the conduit and to a minimum depth of 3 feet below finish grade as measured from the top of the conduit. If deeper depths are required, the conduit shall be installed at the depth shown on the plans or as directed. Conduit shall not interfere with poles, guardrail posts, sign foundations or other objects.”

Amend the third paragraph which begins with “All junction or pull boxes...” by adding “**concrete, in accordance with the applicable requirements of Section 502 – Structural Concrete,**” after Class LP.

Revise the fifth paragraph which begins with “After the trench has been...” by adding the following to the end of it:

“Where concrete encasement is required around the conduit, backfilling with approved material may begin adjacent to and above the encased conduit no sooner than 24 hours after concrete placement.”

Remove the following:

“All underground conduit shall be placed to at least the depth shown on the plans and shall not interfere with poles, guardrail posts, sign foundations or other objects.”

Revise the paragraph beginning with “All conduit ends shall...” by removing “Prewired Conduit shall be sealed during construction to prevent entry of moisture, dirt, or rocks.”

626.033 Polyvinylchloride Conduit Installation Amend the first paragraph of this section which begins with “Polyvinylchloride conduit and High Density...” by adding the following to the end of it:

“In addition, PVC conduit used for Electrical Supply Lines and Services feeding control cabinets for traffic signalization equipment or highway lighting breaker boxes shall be concrete encased. When trenchless technologies are used to install PVC conduit, concrete encasement shall not be required.

Concrete encasement shall consist of a minimum of 4 inches of concrete above, below and on both sides of the conduit that shall have a minimum compressive strength of 3000 psi and a maximum aggregate size of 1-inch (Fill Class concrete). The concrete encasement may be backfilled no sooner than 24 hours after placement. “

“NON-METALLIC UNDER PAVEMENT CONDUIT INSTALLATION

Where noted on the drawings, non-metallic under pavement conduit of schedule 80 or greater rating shall be provided to facilitate conduit crossing of the existing highway and ramps without disruption to the existing highway and ramp pavement surface. The non-metallic under pavement conduit shall be hydraulically jacked or directional bored below the highway and ramp at a depth of not less than (36 inches). Under pavement conduit shall extend for a distance of (10 feet) beyond the highway or ramp edge at each side.”

Amend the sixth paragraph which begins with “Where PVC conduit runs are...” by changing “3 inch minimum bedding” to “**6 inch minimum bedding**”.

626.034 Concrete Foundations

Revise this section by removing the third paragraph which begins with “In the absence of Design Requirements...” in its entirety and replace with the following:

“In the absence of design requirements being provided on the plans, the Contractor shall prepare and submit the foundation design(s) to the Department for review. The Contractor may propose an alternate shallow spread footing or drilled shaft configuration/design than that set forth on the drawings. Design shall be in accordance with AASHTO LRFD Specifications for Structural Supports for Highway Sign, Luminaires and Traffic Signals, current edition; AASHTO LRFD Bridge Design Specifications, current edition; and FHWA-NHI-10-016 Drilled Shafts, Construction Procedures and Design Methods, current edition. Where conflicting requirements occur, the more stringent requirements shall govern. In addition to other design requirements, foundation design shall account for Torsion for which a minimum Factor of Safety equal to 1.2 shall be achieved. In evaluating axial capacity and torsional resistance in cohesionless soils, load transfer coefficient or side resistance coefficient (beta, β) will be used in accordance with Subsection 13.3.5.1 of FHWA-NHI-10-016, with beta determined in accordance with Equations 13-13 and 13-11 for silty sands to sandy silts (with varying amounts of gravel). The design criteria for the resistance of drilled shaft and spread footing foundations against overturning, sliding and bearing capacity failure shall meet the requirements of Section 4 of AASHTO LRFD Bridge Design Specifications, current edition. The structural design of foundations shall meet the requirements of AASHTO LRFD Bridge Design Specifications, current edition. The Contractor shall submit to the Department for review, three (3) copies of detailed plans and calculations of the proposed design. Design shall be prepared and sealed by a Professional Engineer licensed in the State of Maine. Construction of foundation(s) shall not commence until the Department has reviewed the foundation design.”

On Page 6-85, add the following paragraph before the paragraph beginning with “Drilled shafts shall not be...”.

“ No foundation design will be required for 18- and 24-inch diameter foundations for structures less than 30-feet tall and with no projecting arms. A foundation design prepared by a Professional Engineer licensed in accordance with the laws of the State of Maine will be required for all other foundations Precast foundations will be permitted for 18 and 24-inch diameter foundations for structures less than 30-feet tall and with no projecting arms. Where precast foundations are permitted flowable concrete fill shall be used as backfill in the annular space, and placed from the bottom up. Construction of precast foundations shall conform to the Standard Details and all requirements of Section 712.061 except that the concrete shall have a minimum permeability of 17 kOhm-cm and the use of calcium nitrite will not be required. “

On Page 6-86, Revise the paragraph beginning with “Concrete for drilled shafts...” so that a portion of it reads as follows:

“...The Contractor shall provide temporary dewatering of excavations for foundations such that concrete is placed in the dry. Concrete for drilled shafts shall be placed in accordance with Section 502.10 as temporary casing is withdrawn to prevent debris from contaminating the foundation and to ensure concrete is cast against the surrounding soil. Concrete for drilled shafts and spread footings shall be Class LP in accordance with Section 502 - Structural Concrete. Precast foundations will not be permitted except as specified above in this Section. Backfill for spread footing foundations shall be Gravel Borrow meeting the requirements of Section 703.20 - Gravel Borrow.....”

626.05 Basis of Payment Amend this section by removing the following paragraphs:
The one which starts with “Payment will be made for the total number of linear feet of prewired conduit...”
The one which starts with “Prewired conduit within the foundations...”

Amend this subsection by adding the following paragraph and Pay Items:

“Payment will be made for the total number of linear feet of under pavement conduit actually furnished, installed and accepted at the contract price per linear foot. This price shall include the cost of: furnishing and installing the conduit; excavating; furnishing special backfilling materials, pull wire, fittings, grounding and bonding; test cleaning interiors of conduits and all materials, labor, equipment and incidentals necessary to complete the work.”

Pay Item	PayUnit
626.221 Non-metallic Conduit, Concrete Encased	Linear Foot
626.251 Non-Metallic Under pavement Conduit (Schedule 80 or greater rating)	Linear Foot

Remove the following Pay Items:

626.23	Prewired Conduit Secondary Wiring	Linear Foot
626.24	Prewired Conduit Primary Wiring	Linear Foot

SECTION 627
PAVEMENT MARKINGS

Revise this section by removing it in its entirety and replacing with the following:

627.01 Description This work shall consist of furnishing and placing reflectorized pavement lines and markings, removing pavement lines and markings, and furnishing and applying reflectorized paint to curbing in reasonably close conformity with the plans and as designated.

627.02 Materials Materials shall conform to the requirements specified in the following Sections of Division 700 - Materials.

Pavement Marking Paint	708.03
Reflectorized Plastic Pavement Marking	712.05

Temporary Bi-directional Yellow Delineators shall be Temporary Object Markers (T.O.M.) as manufactured by the Davidson Plastic Company, 18726 East Valley Highway, Kent, WA 98031 or an approved equal.

627.04 General All pavement lines and markings shall be applied in accordance with the latest edition of Manual on Uniform Traffic Control Devices.

Longitudinal lines placed on tangent roadway segments shall be straight and true. Longitudinal lines placed on curves shall be continuous smoothly curved lines consistent with the roadway alignment. All pavement markings placed shall meet the tolerance limits shown on the plans.

Unless otherwise shown on the plans, non-interstate lines shall be 4 inches wide and broken lines shall consist of alternate 10 foot painted line segments and 30 foot gaps. On controlled access divided highways and on the interstate system lines shall be 6 inches wide and broken lines shall consist of alternate 15 foot painted line segments and 25 foot gaps. Width tolerance shall be +/- 1/4 inch.

Temporary pavement marking lines, defined in Special Provision Section 652, Maintenance of Traffic, Temporary Centerline, will be applied as many times as necessary to properly delineate traffic lanes for the safe passage of traffic. Bi-directional delineators may be used in place of temporary lines, except where specified otherwise in Special Provision 652 Maintenance of Traffic, Temporary Centerline. Delineators will be applied at 40 foot intervals.

In overnight lane closure areas that are not to be overlaid, temporary plastic lines or raised pavement markers shall be used through the length of the taper.

Newly painted lines, markings and curb shall be protected from traffic by the use of cones, stationary vehicles or other approved methods until the paint is dry.

627.05 Preparation of Surface Immediately before applying the pavement marking paint to the pavement or curb, the surface shall be dry and entirely free from dirt, grease, oil, or other foreign matter.

Surface preparation for application of plastic markings shall conform to the manufacturer's recommendations.

627.06 Application Prior to applying paint for final pavement lines, the Contractor shall perform a test for paint thickness by furnishing and placing a piece of smooth, clean metal with an area of at least 144 in² in the path of the striping truck. The striping truck shall be passed over the piece of metal, painting the surface as it passes, without applying beads. The result of this test will be used to determine the pressure setting and speed of the truck when applying paint to obtain the specified thickness. Additional paint thickness testing may be required on the final paint markings. The wet thickness of paint without beads on final pavement lines shall be a minimum of 16 mils.

On other final pavement markings and on curb, where the paint is applied by hand painting or spraying, application shall be in two uniform covering coats, each at least 10 mils thick. Before the second coat of paint has dried, the glass beads shall be applied by a pressure system that will force the glass beads onto the undried paint as uniformly as possible.

Glass beads shall be applied to the final and temporary pavement lines, marking and curb at a sufficient rate and in sufficient quantity to assure complete and uniform coverage of hand painted surfaces and achieve proper reflectivity.

Permanent and temporary white lines and markings shall have a minimum final reflectivity value of 250 millicandelas per square meter per lux (mcd/m²/lux) and permanent and temporary yellow lines and markings shall have a minimum final reflectivity value of 150 millicandelas per square meter per lux (mcd/m²/lux), as measured by the Department. Measurements taken to determine reflectivity shall be done within 4 weeks after final placement.

If the final reflectivity values are less than the described minimums, the Contractor shall repaint those areas not meeting required reflectivity at no cost to the Department. If the final reflectivity values are less than the described minimums after the second attempt, the Contractor will submit in writing a plan of action to meet the reflectivity minimums prior to continuing any work. Once the plan has been reviewed and approved by the Department, the Contractor shall re apply at no cost to the Department.

Temporary painted lines and markings shall be applied as specified for permanent painted lines, except that the thickness shall be a minimum of 16 mils.

Temporary pliant polymer marking material shall be used for temporary markings on the final pavement and on pavements not to be resurfaced when such pavement markings do not conform to the final pavement markings pattern.

The plastic final pavement lines and markings shall be applied in accordance with the manufacturer's recommendations by the inlay method of application.

627.07 Establishment Period Inlaid plastic pavement lines and marking material furnished and installed under this contract for final pavement markings shall still be subject to a six-month period of establishment.

The period of establishment shall commence as soon as the plastic pavement lines and markings are complete and in place and shall continue for six months. At the end of the establishment period, a minimum of 95% of the plastic pavement lines and markings shall still be in place to be acceptable.

If less than 95% of the plastic pavement lines and markings are in place after six months, the Contractor shall replace all unsatisfactory plastic pavement lines and markings on the project without additional payment. Plastic pavement lines and markings designated for replacement shall be installed according to these specifications, unless otherwise directed. Plastic pavement lines and markings replaced at the end of the six month establishment period will not be subject to a further establishment period.

627.08 Removing Lines and Markings When it is necessary to remove pavement lines and markings, it shall be done by high pressure water, grinding or other approved acceptable means. The method chosen must be capable of completely eradicating the existing line or marking without excessive damage to the pavement. Burning and the use of solvents to remove temporary markings from final pavement or from existing pavement not to be resurfaced will not be permitted.

627.09 Method of Measurement The quantity of pavement marking lines identified in the contract as a plan quantity pay item, the measurement of payment will be the number of feet shown in the Schedule of Items. This quantity will be considered final and no adjustments will be made except when changes resulting in increases or decreases are made by the Resident.

The accepted quantity of temporary or permanent pavement marking lines when identified in the contract as a linear foot item shall be measured and paid for at the contract unit price per linear foot for the total amount applied and accepted.

Double yellow centerline, broken or solid, will be considered one line for measurement purposes. The measurement of broken lines will include the gaps when painted and will not include the gaps when plastic. Double Yellow Centerline, broken or solid shall not be paid through intersections or side roads and will be paid for the actual length of painted line.

Broken white lines will include the gaps when painted and will not include the gaps when plastic inlaid pavement lines are applied. Yellow or white solid edge lines and will not be paid through intersections or side roads and will be measured by the actual length of painted line.

Temporary pavement marking lines shall not be paid through intersections or side roads and will be measured per linear foot of actual length of painted and accepted.

Reflectorized curb will be measured or computed by the square foot of curb surface actually painted and reflectorized.

The accepted quantity of removing existing pavement markings will be measured by the square foot.

Temporary Bi-directional Yellow Delineators will be measured by each unit, complete in place, maintained, and accepted.

627.10 Basis of Payment The accepted quantity of pavement marking lines identified in the contract as a plan quantity pay item will be paid for at the contract unit price for plan quantity. No adjustment will be made to the quantity for payment, except as described 627.09 Method of Measurement

The quantity of permanent or temporary pavement marking lines identified in the contract paid by the linear foot will be measured for payment as described under section 627.09 Method of Measurement.

All other permanent pavement markings will be paid for at the contract unit price per square foot in accordance with 627.09 Method of Measurement.

If allowed by Special Provision, the Contractor may utilize Temporary Bi-Directional Yellow and White (as required) Delineators. When utilized, payment will be made as temporary pavement marking lines, measured and paid at the contract unit price per linear foot. Such payment will include as many applications as required and removal.

Payment for final plastic pavement lines and markings will be made in two parts. The first payment of 75% will be made when plastic pavement lines and markings are placed. The payment of the remaining 25% will be made at the end of the establishment period for all plastic line and pavement markings accepted.

The accepted quantity of any pavement marking lines will be paid for at the contract unit price and will include as many applications as required and removal when required.

The accepted quantity of Temporary Bi-directional Yellow Delineators will be paid for at the contract unit price.

Payment will be made under:

<u>Pay Item</u>	<u>Pay Unit</u>
627.18 12 inch Solid White Pavement Marking Line	Linear Foot
627.711 White or Yellow Pavement Marking Line - Plan Quantity	Linear Foot
627.733 4" White or Yellow Painted Pavement Marking Line	Linear Foot
627.744 6" White or Yellow Painted Pavement Marking Line	Linear Foot
627.75 White or Yellow Pavement & Curb Marking	Square Foot
627.77 Removing Existing Pavement Marking	Square Foot
627.78 Temporary 4" Painted Pavement Marking Line, White or Yellow	Linear Foot
627.781 Temporary 6" Painted Pavement Marking Line, White or Yellow	Linear Foot
627.407 Reflectorized Plastic, White or Yellow Pavement Marking	Square Foot
627.4071 Reflectorized Plastic, White or Yellow Pavement Marking Line - Plan Quantity	Linear Foot
627.811 Temporary Bi-directional Yellow Delineators	Each

SECTION 639 ENGINEERING FACILITIES

Revise this section by removing this section in its entirety and replace with the following:

639.01 Description This work shall consist of providing, erecting, lighting, equipping and maintaining buildings to be solely used by the Resident and other assigned Department representatives as a field office. Upon completion of the work, the buildings and equipment shall remain the property of the Contractor.

639.02 Materials Materials for buildings shall be of good quality customarily used in standard frame house or office trailer construction.

639.03 General The building of the type called for shall be provided before the start of work, and shall remain until work is completed and accepted, unless earlier removal is authorized. The location shall be approved by the Resident and should be adjacent or virtually adjacent to the Project.

A fire extinguisher shall be provided in each building or office trailer for electrical and chemical fires and effective on all solvents used in the building.

Walls, roof, floor, windows, and doors shall be tightly constructed to the required area.

Furnishings shall be supplied as called for. Doors shall be equipped with locks and all keys shall be in the possession of the Resident. Windows shall be equipped with latches so they may be locked on the inside. Window screens and screen doors shall be supplied when necessary. Adequate desk and desk space shall be provided. If a portable table is supplied, it should be adjustable to accommodate the various heights of employees. A 5-way adjustable office chair shall be provided in the quantities listed.

639.04 Field Offices Field Offices are designated Type A, Type B, or Type C. Buildings, including trailers, may be provided if they substantially equal or exceed the following requirements. Air conditioning, appropriate to the building size, shall be provided in all field offices.

The walls, roof, and floor of the building shall be completely insulated with a minimum insulation value of R-15. Office trailers shall be either new or in very good used condition. The interior walls shall be covered with suitable wall paneling. The entire office trailer shall be for the exclusive use of the Resident. The office trailer shall be winterized and completely enclosed at the bottom, if the trailer will be used in cold weather.

Other types of buildings and facilities may be furnished of equal or better quality.

A public work area will be provided in the field office that shall be designed and constructed so that individuals with disabilities can approach, enter, and exit this area.

At least one accessible route to the field office shall be provided from accessible parking. The accessible route shall comply with the Americans with Disabilities Act Accessibility Guidelines (ADAAG) and this specification.

The minimum clear width of an accessible route shall be 36 inches except at doors. The least possible slope shall be used for an accessible route. An accessible route with a running slope greater than 1:20 shall be considered a ramp. Maximum ramp slope is 1:12. The maximum rise for any run of a ramp shall be 30 inches and the minimum clear width shall be 36 inches. Nowhere shall the cross slope of an accessible route exceed 1:50. Changes in level up to ¼ inch may be vertical and without edge treatment. Changes in level between ¼ inch and ½ inch shall be beveled with a slope no greater than 1:2. Ramp floor surfaces shall be stable, firm, and slip-resistant.

Ground floor surfaces along accessible routes and in accessible rooms and spaces including floors, walks, ramps, stairs, and curb ramps, shall be stable, firm, and slip-resistant.

The main door to the public work area shall have a minimum clear opening of 32 inches with the door opened 90 degrees, measured between the face of door and the opposite stop. Minimum maneuvering clearances at doors shall be provided. The floor or ground area within the required clearances shall be level and clear.

The handle and other operating devices on accessible doors shall have a shape that is easy to grasp with one hand and does not require tight grasping. Lever-operated mechanisms push type mechanisms, and U-shaped handles are acceptable designs. Hardware required for accessible door passage shall be mounted no higher than 48 inches above finished floor.

A minimum of 3 parking spaces will be supplied for Class B & C Field Offices and 6 for Class A. One wheelchair accessible parking space shall be located on the shortest accessible route of travel from adjacent parking to an accessible entrance.

Level landings shall be provided at bottom and top of each run. The landing shall be at least as wide as the ramp run leading to it with a minimum length of 60 inches.

If a ramp run has a rise greater than 6 inches or a horizontal projection greater than 72 inches, then it shall have handrails on both sides. Handrails shall have the following features:

- 1) Handrails shall be provided along both sides of ramp segments. The inside handrail on switchback ramps shall always be continuous.
- 2) If handrails are not continuous, they shall extend at least 12 inches beyond the top and bottom of the ramp segment and shall be parallel with the floor or ground surface.
- 3) The clear space between the handrail and the wall shall be 1½ inch.
- 4) Gripping surfaces shall be continuous.
- 5) Top of handrail gripping surfaces shall be mounted between 34 and 38 inches above ramp surfaces.

- 6) Ends of handrails shall be either rounded or returned smoothly to floor, wall, or post.
- 7) Handrails shall not rotate within their fittings.
- 8) The diameter or width of the gripping surfaces of a handrail shall be 1¼ to 1½ inch, or the shape shall provide an equivalent gripping surface.

Firm and sturdy steps shall also be provided with 7 inch maximum riser and 11 inch minimum depth, and at least one handrail extending from the top of the steps to a minimum 12 inches beyond the bottom of the steps.

The Contractor will make reasonable effort(s) to provide wheelchair accessible toilet facilities when "portable" facilities are provided.

The Contractor shall provide wheelchair accessible toilet facilities when flush type facilities, that is, those with running water, are provided; and the Contractor shall provide wheelchair accessible portable facilities, if used, when the contract duration exceeds two continuous construction seasons.

In addition to the facilities previously specified in this subsection, each field office shall meet the following minimum requirements:

<u>Description</u>	<u>Quantity</u>		
	<u>Type A</u>	<u>Type B</u>	<u>Type C</u>
Floor Area (Outside Dimension) - ft ²	312	220	125
Inside Wall Height – feet	7	7	7
Window Area - ft ²	55	35	35
Drafting Table Surface Area - ft ²	15	15	15
Drafting Stools - each	2	1	1
Office Desks - each	2	1	1
Ergonomic Swivel Chairs -ea (5-way adjustable)	3	2	2
Folding Chairs - each	3	2	2
Lighting Units - each	4	2	2
Electric Wall Outlets - each	6	4	3
Power Strip Surge Protectors - each	3	2	1
Wall Closets - each	1	1	1
Plan Rack for minimum of 6 sets of plans	1	1	0
Toilet Facility	1	1	1
Wastebaskets - each	2	2	1

All windows shall be provided with shades or blinds.

The toilet facility shall be for the exclusive use of State personnel. If requested, the Contractor will supply a lock to ensure exclusive use.

The Resident will have the option to reject any furniture or supplies provided to the field office based on general condition.

One hundred ten volt, 60 cycle, continuous electric service shall be supplied for lighting and 15 amp duplex wall outlets. Lighting shall consist of florescent light units with rapid start bulbs or LED shop style lights located over the work areas for a minimum of 50 foot candles overall. At least one external light source will be provided.

Drafting surfaces shall be 40 inches above the floor and have shelves beneath. Shelves for plans and rolls shall also be furnished overhead. Drafting stools shall be approximately 28 inches high.

Desks shall be single or double pedestal standard office type, and shall be in addition to “built-in” type desks in the office trailer.

Field offices shall be furnished with one four-drawer letter size metal filing cabinet.

Wall closets shall be 21 inches wide, 15 inches deep, and at least 4 feet high.

Each office shall be furnished with a broom, dustpan, sweeping compound, trash bags, and with cleaning material for cleaning glass. If the field office is carpeted, then a vacuum cleaner will be provided. The contractor will be responsible for disposing of trash from the field office.

The Contractor shall provide a fully functional wireless desktop copier/scanner/printer, capable of copying field books, for the Resident’s use during the project. All maintenance and supplies, except paper, shall be the responsibility of the Contractor.

The Contractor shall provide bottled water and a microwave for the duration of the project. All maintenance and supplies shall be the responsibility of the Contractor. Alternate source of water, such as a water cooler, may be provided as approved by resident.

The Contractor shall provide a 4 cubic-foot refrigerator in the field office for the duration of the project.

Each office shall be furnished with a 10-person general-purpose first aid kit. The first aid kit shall be periodically inspected and refilled as necessary.

639.08 Heat Heat appropriate to the building size shall be supplied by the Contractor to maintain an acceptable room temperature during occupancy.

639.091 Broadband Connection The contractor will supply one computer broadband connection, modem lease and router. The router shall have wireless access and be 802.11n or newer capable. The type of connection supplied will be contingent upon the availability of services (i.e. DSL or Cable Broadband). It shall be the contractor's option to provide dynamic or static IP addresses through the service. The selected service will have a minimum download connection of 5.0 Mbps and 1.0 Mbps upload. The contractor shall be responsible for the installation charges and all reinstallation charges following suspended periods. Monthly service and maintenance charges shall be billed by the Internet Service Provider (ISP) directly to the contractor.

639.10 Method of Measurement Field office will be measured by the unit or lump sum for each building provided, equipped and maintained satisfactorily.

639.11 Basis of Payment The accepted quantity of field office will be paid for at the contract unit price each or lump sum which payment shall be full compensation for furnishing until contract completion, erecting, equipping, maintaining, furnishing electricity, heating, installing and maintaining toilet facilities and if necessary removing the buildings or office trailers.

Payment for these items will be made in 3 parts; the first payment of ½ to be made after the Contractor has supplied the building or office trailer and it has been approved. The remaining payments shall be made at intervals as follows:

A second payment of ¼ shall be made when one-half of the anticipated work has been completed.

The final payment of the remaining ¼ shall be made upon completion of the work.

Payment will be made under:

	<u>Pay Item</u>	<u>Pay Unit</u>
639.18	Field Office, Type A	Each
639.19	Field Office, Type B	Each
639.20	Field Office, Type C	Each

SECTION 652 **MAINTENANCE OF TRAFFIC**

652.2.4 Other Devices Revise this Section by removing the following paragraph:
“ STOP/SLOW paddles shall be the primary and preferred hand held signaling device. Flags shall be limited to Emergencies. The paddle shall have an octagonal shape and be at least 18 inches wide with letters at least 6 inches high and should be fabricated from semi-rigid material”

And replace with these two paragraphs

“Flaggers shall use a STOP / SLOW hand held paddle as the primary and preferred hand signaling device. Use of flags shall be limited to emergency situations.

STOP / SLOW paddles shall have high intensity prismatic retro reflective sheeting Type XI, have an octagonal shape on a rigid handle and shall be at least 18 inches wide with letters at least 6 inches high and shall be constructed from light semi-rigid material. The STOP (R1-1) face shall have white letters and a white border on a red background. The SLOW (W20-8) face shall have black letters and a black border on an orange background. Paddles in existing stock meeting the current specification (Type VII, Type VIII, or Type IX) may be utilized until the end of the service life or until 12/31/18. All new paddles must meet the Type XI requirements.”

652.3.3 Submittal of Traffic Control Plan On page 6-148, note f, in the last sentence revise the “105.2.2” to “105.2.3” so that the last sentence reads, **“For a related provision, see Section 105.2.3 – Project Specific Emergency Planning.”**

652.3.4 General Revise the eighth paragraph by removing “Earth Berm” and replace it with **“Concrete Barrier”**.

Amend this section by adding the following paragraph before the paragraph beginning with “Special Detours and temporary structures...”:

“A temporary ramp shall be constructed with HMA at the ends of the roadway section paved or milled each day. The use of millings or RAP will not be allowed, but cold patch may be temporarily utilized until HMA plants are open for the season. The maximum ramp change in elevation shall not exceed 4” vertical. For Interstate Highways or roadways with speed limits equaling or exceeding 50 mph; temporary ramps shall be constructed at a length of eight feet per inch of transition depth. For roadways with speed limits less than 50 mph and greater than 25 mph, temporary ramps shall be constructed at a length of four feet per inch of transition depth. For roadways with speed limits 25 mph or less, temporary ramps shall be constructed at a length of two feet per inch of transition depth. Materials, placement, maintenance, and removal shall be incidental to contract items.”

652.4 Flaggers Revise this section by removing the first paragraph, and replace it with the following”

“The Contractor shall furnish flaggers as required by the TCP or as otherwise specified by the Resident. All flaggers must have successfully completed a flagger test approved by the Department and administered by a Department-approved Flagger-Certifier. All flaggers must carry an official certification card with them at all times while flagging.

For daytime conditions, flaggers shall wear a top (vest, shirt or jacket) that is orange, yellow, yellow-green, or fluorescent versions of these colors meeting ANSI 107-2004, Class 2 or Class 3, along with a hardhat with 360 ° retro-reflectivity.

For nighttime conditions, flaggers shall wear all Class 3 apparel, meeting ANSI 107-2004, including a Class 3 top (vest, shirt or jacket) and a Class E bottom (pants or coveralls), shall be worn along with a hardhat with 360 ° retro-reflectivity and shall be visible at a minimum distance of 1000 ft. Flagger stations must be illuminated in nighttime conditions to assure visibility and will be specifically addressed in detail in the Contractor’s TCP”.

652.41 TRAFFIC OFFICERS

Revise this subsection so that the subsection number and title is

“652.4.1 TRAFFIC OFFICERS ”

SECTION 656

TEMPORARY SOIL EROSION AND WATER POLLUTION CONTROL

656.5.2 If No Pay Item Add the following to the end of the first paragraph:

“Failure by the Contractor to follow Standard Specification or Special Provision - Section 656 will result in a violation letter and a reduction in payment as shown in the schedule list in 656.5.1. The Department’s Resident or any other representative of The Department reserves the right to suspend the work at any time and request a meeting to discuss violations and remedies. The Department shall not be held responsible for any delay in the work due to any suspension under this item.”

SECTION 660

ON-THE-JOB TRAINING

660.06 Method of Measurement

Remove the first sentence in its entirety and replace with **“ The OJT item will be measured by the number of OJT hours by a trainee who has successfully completed an approved training program.”**

660.07 Basis of payment to the Contractor

Remove the last word in the first sentence so that the first sentence reads **“ The OJT shall be paid for once successfully completed at the contract unit price per hour.”**

Payment will be made under

Change the Pay Item from **“660.22”** to **“660.21”** and change the Pay Unit from **“Each”** to **“Hour”**.

SECTION 672

PRECAST CONCRETE BLOCK GRAVITY WALL

672.035 Backfill Material– Revise this section by adding the following after the second paragraph: **Backfill materials shall meet the criteria in the following table.**

<u>Base Polymer</u>	<u>Property</u>	<u>Criteria</u>	<u>Test Method</u>
Polyester (PET)	pH	3 < pH < 9	AASHTO T-289
Polyolefin (PP & HDPE)	pH	pH > 3	AASHTO T-289

672.04 Design Requirements – Revise this section by replacing items 2 and 3 in the second paragraph with the following:

- 2. FHWA-NHI-10-024 and FHWA-NHI-10-025, Design and Construction of Mechanically Stabilized Earth Walls and Reinforced Soil Slopes, Volumes I and II, current edition.**
- 3. FHWA-NHI-09-087 Corrosion/Degradation of Soil Reinforcements for Mechanically Stabilized Earth Walls and Reinforced Soil Slopes, current edition.**

SECTION 673 **WETCAST SMALL LANDSCAPE BLOCK WALL**

673.035 Backfill Material – Revise this section by adding the following after the second paragraph:

Backfill materials shall meet the criteria in the following table.

<u>Base Polymer</u>	<u>Property</u>	<u>Criteria</u>	<u>Test Method</u>
Polyester (PET)	pH	3 < pH < 9	AASHTO T-289
Polyolefin (PP & HDPE)	pH	pH > 3	AASHTO T-289

673.04 Design Requirements – Revise this section by replacing items 2 and 3 in the second paragraph with the following:

- 2. FHWA-NHI-10-024 and FHWA-NHI-10-025, Design and Construction of Mechanically Stabilized Earth Walls and Reinforced Soil Slopes, Volumes I and II, current edition.**
- 3. FHWA-NHI-09-087 Corrosion/Degradation of Soil Reinforcements for Mechanically Stabilized Earth Walls and Reinforced Soil Slopes, current edition**

SECTION 674

PREFABRICATED CONCRETE MODULAR GRAVITY WALL

674.02 Materials

Amend this section by adding the following after “Concrete Units:” and before the paragraph beginning with “Tolerances”.

Concrete shall be Class P. The concrete shall contain a minimum of 5.5 gallons per cubic yard of calcium nitrite solution.

The minimum permeability of the concrete as indicated by Surface Resistivity shall be 17 KOhm-cm.

Defects Defects which may cause rejection of precast units include, but are not limited to, the following:

Any discontinuity (crack, rock pocket, etc.) of the concrete which could allow moisture to reach the reinforcing steel.

Rock pockets or honeycomb over 6 square inches in area or over 1 inch deep.

Edge or corner breakage exceeding 12 inches in length or 1 inch in depth.

Any other defect that clearly and substantially impacts the quality, durability, or maintainability of the structure, as determined by the Fabrication Engineer.

Repair honeycombing, ragged or irregular edges and other non-structural or cosmetic defects using a patching material from the MaineDOT Qualified Products List (QPL). The repair, including preparation of the repair area, mixing and application and curing of the patching material, shall be in accordance with the manufacturer's product data sheet. Corners that are not exposed in the final product may be ground smooth with no further repair necessary if the depth of the defect does not exceed 1/2 inch. Remove form ties and other hardware to a depth of not less than 1 inch from the face of the concrete and patch the holes using a patching material from the MaineDOT QPL.

Repair structural defects only with the approval of the Fabrication Engineer. Submit a nonconformance report (NCR) to the Fabrication Engineer with a proposed repair procedure. Do not perform structural repairs without an NCR that has been reviewed by the Fabrication Engineer. Structural defects include, but are not be limited to, exposed reinforcing steel or strand, cracks in bearing areas, through cracks and cracks 0.013 inch in width that extend more than 12 inches in length in any direction. Give the QAI adequate notice prior to beginning any structural repairs.

SECTION 677

MECHANICALLY STABILIZED EARTH RETAINING WALL

677.03 Design Requirements – Revise this section by replacing items 6, 7 and 8 in the second paragraph with the following:

- 6. FHWA-NHI-10-024, Design and Construction of Mechanically Stabilized Earth Walls and Reinforced Soil Slopes, Volumes I, current edition.**
- 7. FHWA-NHI-10-025, Design and Construction of Mechanically Stabilized Earth Walls and Reinforced Soil Slopes, Volumes II, current edition.**
- 8. FHWA-NHI-09-087 Corrosion/Degradation of Soil Reinforcements for Mechanically Stabilized Earth Walls and Reinforced Soil Slopes, current edition**

On page 6 - 203 change “636.041” to “677.041”

Amend 677.042 Precast Panel Tolerances and Surface Finish by the addition of the following:

Defects Defects which may cause rejection of precast units include, but are not limited to, the following:

Any discontinuity (crack, rock pocket, etc.) of the concrete which could allow moisture to reach the reinforcing steel.

Rock pockets or honeycomb over 6 square inches in area or over 1 inch deep.

Edge or corner breakage exceeding 12 inches in length or 1 inch in depth.

Any other defect that clearly and substantially impacts the quality, durability, or maintainability of the structure, as determined by the Fabrication Engineer.

Repair honeycombing, ragged or irregular edges and other non-structural or cosmetic defects using a patching material from the MaineDOT Qualified Products List (QPL). The repair, including preparation of the repair area, mixing and application and curing of the patching material, shall be in accordance with the manufacturer's product data sheet. Corners that are not exposed in the final product may be ground smooth with no further repair necessary if the depth of the defect does not exceed 1/2 inch. Remove form ties and other hardware to a depth of not less than 1 inch from the face of the concrete and patch the holes using a patching material from the MaineDOT QPL.

Repair structural defects only with the approval of the Fabrication Engineer. Submit a nonconformance report (NCR) to the Fabrication Engineer with a proposed repair procedure. Do not perform structural repairs without an NCR that has been reviewed by the Fabrication Engineer. Structural defects include, but are not be limited to, exposed reinforcing steel or strand, cracks in bearing areas, through cracks and cracks 0.013 inch in width that extend more than 12 inches in length in any direction. Give the QAI adequate notice prior to beginning any structural repairs.

SECTION 702
BITUMINOUS MATERIAL

702.01 Asphalt Cement - Remove this section in its entirety and replace with the following:

Performance-Graded Asphalt Binder (PGAB) that has not been modified with polymer shall conform to the requirements of AASHTO M 320. Polymer modified binder shall meet the requirements of AASHTO M 332 (including Appendix X1), except that the percent difference in nonrecoverable creep compliance, J_{nr}diff, shall not be enforced. Performance-Graded Asphalt Binder shall not contain re-refined engine oil bottoms (REOB).

The Contractor shall arrange for the Supplier to furnish the following items to the Department's Asphalt Pavement Engineer:

a. A Quality Control Plan that conforms to the requirements of AASHTO R 26 "Certifying Suppliers of Performance-Graded Asphalt Binders" and

b. A CERTIFICATE OF ANALYSIS for all asphalt materials furnished for use on the project. The Certificate shall include the actual test results of the material in storage from which the shipments are being made. Certificates shall be supplied for each lot, batch, or blend of each type and grade of material. A new certificate shall be issued at least every 30 days or upon receiving or manufacture of a new material. The original of each Certificate of Analysis shall be mailed to the Departments Asphalt Pavement Engineer.

The Contractor shall give the supplier sufficient notice of orders to permit testing and certification. Material not certified will not be accepted for use.

Deliveries of asphalt materials shall be accompanied by a Bill of Lading containing the information required under Section 108.1.3 f. The Bill of Lading shall include the applicable certificate number and shall include a printed or stamped statement such as the following: "THIS IS TO CERTIFY THAT THE ASPHALT MATERIAL REPRESENTED BY THIS LOADING INVOICE CONFORMS TO THE SPECIFICATIONS OF THE PURCHASER FOR THE MATERIAL TYPE AND GRADE STATED THEREON."

In the event an intermediate hauler of the asphalt material is involved, a copy of their own delivery slip shall be furnished, as well as a copy of the supplier's loading invoice. The hauler's delivery slip and the supplier's loading invoice shall be cross-referenced by use of their respective serial numbers.

All non-bituminous components added to the binder prior to the sampling point for binder certification shall be included on the asphalt binder Certificate of Analysis identifying their presence. All non-bituminous components added after the certification sampling point and prior to transport shall be included on the Bill of Lading. All non-bituminous components added to the binder at the HMA plant shall be identified on the mix plant documentation and accompanied by test results and certification showing the effect of the additives introduced, if any.

702.04 Emulsified Asphalt

Revise this Section by removing the first paragraph in its entirety and replace with the following:

Emulsified Asphalt shall conform to the requirements of AASHTO M 140. Cationic emulsified asphalt shall conform to the requirements of AASHTO M 208. Anionic emulsified asphalt Grade RS-1h shall conform to the requirements in the following table:

Type	Rapid-Setting	
Grade	RS-1h	
Tests on Emulsions	min	max
Viscosity, Saybolt Furol at 25°C SFS	20	100
Storage Stability test, 24-h, % ^A	-	1.0
Demulsibility, 35 ml, 0.02 N CaCl ₂ , %	60	-
Sieve Test, % ^A	-	0.10
Residue by distillation, %	55	-
Tests on Residue from Distillation Test	min	max
Penetration, 25°C 100g, 5 s	40	90
Ductility, 25°C 5 cm/min, cm	40	-
Solubility in trichloroethylene or n-propyl bromide, %	97.5	-

^A This requirement is waived if successful application of material has been achieved in the field.

SECTION 703
AGGREGATES

703.01 Fine Aggregate for Concrete Replace the second paragraph with the following:

“All fine aggregate shall be free from injurious amounts of organic impurities. Should the fine aggregate, when subjected to the colorimetric test for organic impurities, AASHTO T 21, produce a color darker than organic plate number 3, the fine aggregate shall be rejected.”

703.0201 Alkali Silica Reactive Aggregates. Remove this section in its entirety and replace with the following:

All coarse and fine aggregates proposed for use in concrete shall be tested for Alkali Silica Reactivity (ASR) potential under AASHTO T 303 (ASTM C 1260), Accelerated Detection of Potentially Deleterious Expansion of Mortar Bars Due to Alkali-Silica Reaction, prior to being accepted for use. Acceptance will be based on testing performed by an accredited independent lab submitted to the Department. Aggregate submittals will be required on a 5-year cycle, unless the source or character of the aggregate in question has changed within 5 years from the last test date.

As per AASHTO T 303 (ASTM C 1260): Use of a particular coarse or fine aggregate will be allowed with no restrictions when the mortar bars made with this aggregate expand less than or equal to 0.10 percent at 30 days from casting. Use of a particular coarse or fine aggregate will be classified as potentially reactive when the mortar bars made with this aggregate expand greater than 0.10 percent at 30 days from casting. Use of this aggregate will only be allowed with the use of cement-pozzolan blends and/or chemical admixtures that result in mortar bar expansion of less than 0.10 percent at 30 days from casting as tested under ASTM C 1567.

Acceptable pozzolans and chemical admixtures that may be used when an aggregate is classified as potentially reactive include, but are not limited to the following:

Class F Coal Fly Ash meeting the requirements of AASHTO M 295.

Ground Granulated Blast Furnace Slag (Grade 100 or 120) meeting the requirements of AASHTO M 302.

Densified Silica Fume meeting the requirements of AASHTO M 307.

Lithium based admixtures

Metakaolin

Pozzolans or chemical admixtures required to offset the effects of potentially reactive aggregates will be incorporated into the concrete at no additional cost to the Department.

703.06 Aggregate for Base and Subbase - Remove the first two paragraphs in their entirety and replace with these:

“The following shall apply to Sections (a.) and (c.) below. The material shall have a Micro-Deval value of 25.0 or less as determined by AASHTO T 327. If the Micro-Deval value exceeds 25.0, the Washington State Degradation DOT Test Method T113, Method of Test for Determination of Degradation Value (January 2009 version) shall be performed, except that the test shall be performed on the portion of the sample that passes the ½ in sieve and is retained on the No. 10 sieve. If the material has a Washington Degradation value of less than 15, the material shall be rejected.

The material used in Section (b.) below shall have a Micro-Deval value of 25.0 or less as determined by AASHTO T 327. If the Micro-Deval value exceeds 25.0 the material may be used if it does not exceed 25 percent loss on AASHTO T 96, Resistance to Degradation of Small-Size Coarse Aggregate by Abrasion and Impact in the Los Angeles Machine. “

703.081 RAP for Asphalt Pavement

Remove this section in its entirety and replace with the following:

703.081 RAP for Asphalt Pavement Recycled Asphalt Pavement (RAP) may be introduced into hot-mix asphalt pavement at percentages approved by the Department according to the MaineDOT Policies and Procedures for HMA Sampling and Testing.

If approved by the Department, the Contractor shall provide documentation stating the source, test results for average residual asphalt content, and stockpile gradations showing RAP materials have been sized to meet the maximum aggregate size requirements of each mix designation. The Department will obtain samples for verification and approval prior to its use.

The maximum allowable percent of RAP shall be determined by the asphalt content, the percent passing the 0.075 mm sieve, the ratio between the percent passing the 0.075 mm sieve and the asphalt content, and Coarse Micro-Deval loss values as tested by the Department. The maximum percentage of RAP allowable shall be the lowest percentage as determined according to Table 4 below:

Table 4: Maximum Percent RAP According to Test Results

Classification	Maximum RAP Percentage Allowed	Asphalt content standard deviation	Percent passing 0.075 mm sieve standard deviation	Percent passing 0.075 mm sieve / asphalt content ratio	Residual aggregate M-D loss value
Class III	10%	≤ 1.0	N/A	≤ 4.0	≤ 18
Class II	20%	≤ 0.5	≤ 1.0	≤ 2.8	
Class I	30%	≤ 0.3	≤ 0.5	≤ 1.8	

The Department will monitor RAP asphalt content and gradation during production by testing samples from the stockpile at approximately 15,000 T intervals (in terms of mix production). The allowable variance limits (from the numerical average values used for mix designs) for this testing are determined based upon the maximum allowable RAP percentage, and are shown below in Table 5.

Table 5: RAP Verification Limits

Classification	Asphalt content (compared to aim)	Percent passing 0.075 mm sieve (compared to aim)
Class III	± 1.5	± 2.0
Class II	± 1.0	± 1.5
Class I	± 0.5	± 0.7

For specification purposes, RAP will be categorized as follows:

Class III – A maximum of 10.0 percent of Class III RAP may be used in any base, intermediate base, surface, or shim mixture. A maximum of 20.0 percent of Class III RAP may be used in hand-placed mixes for item 403.209.

Class II – A maximum of 20.0 percent Class II RAP in any base, binder, surface, or shim course.

Class I – A maximum of 20.0 percent Class I RAP may be used in any base, intermediate base, surface, or shim mixture without requiring a change to the specified asphalt binder. A maximum of 30.0 percent Class I RAP may be used in in any base or intermediate base mixture provided that a PG 58-28 asphalt binder is used. A maximum of 30.0 percent Class I RAP may be used in any surface or shim mixture provided that PG 58-34 or 52-34 asphalt binder is used. Mixtures exceeding 20.0 percent Class I RAP must be evaluated and approved by the Department.

The Contractor may use up to two different RAP sources in any one mix design. The total RAP percentage of the mix shall not exceed the maximum allowed for the highest classification RAP source used (i.e. if a Class I & Class III used, total RAP must not exceed 30.0%). The blended RAP material must meet all the requirements of the classification for which the RAP is entered (i.e. 10% Class III with 20% Class I, blend must meet Class I criteria). The Department may take belt cuts of the blended RAP to verify the material meets these requirements. If the Contractor elects to use more than one RAP source in a design, the Contractor shall provide an acceptable point of sampling blended RAP material from the feed belt.

In the event that RAP source or properties change, the Contractor shall notify the Department of the change and submit new documentation stating the new source or properties a minimum of 72 hours prior to the change to allow for obtaining new samples and approval.

703.19 Granular Borrow

Remove the gradation requirements table, and replace with the following:

Sieve Designation	Percentage by Weight Passing Square Mesh Sieves	
	Material for Underwater Backfill	Material for Embankment Construction
6 inch	100	
No. 40	0-70	0-70
No. 200	0-7.0	0-20.0

703.33 Stone Ballast - In the third paragraph, remove the words “less than” before 2.60 and add the words “or greater” after 2.60.

SECTION 708 PAINTS AND PRESERVATIVES

708.05 Timber Preservative Revise this section by removing it in its entirety and replacing with:
“Timber preservatives shall conform to the requirements of AASHTO M 133 and AWPA Standard U1. All preservatives shall meet the requirements of the US EPA regulations under the Federal Insecticide, Fungicide and Rodenticide Act.”

SECTION 710 FENCE AND GUARDRAIL

710.07 Guardrail Posts Amend subsection ‘a’ by removing the words “white oak”, “cedar”, “tamarack”, “maple”, “beech”, “birch” and “red oak” from the first sentence. Also in the first sentence, place an “or” between “pine” and “eastern hemlock”. In the second sentence remove the words “well seasoned”. Remove the sentence beginning with “Wood posts and offset brackets...” and replace it with: **“Wood posts and offset brackets shall be preservative treated in accordance with the requirements of AASHTO M 133 and AWPA U1, UC4A Commodity Specification A: Sawn Products.”**

SECTION 712 MISCELLANEOUS HIGHWAY MATERIAL

712.061- Structural Precast Concrete Units

Under the heading, Quality Control and Quality Assurance, revise the fourth paragraph to read:

“Acceptance is the prerogative of the Department. The Department will conduct Quality Assurance (QA) in accordance with Standard Specification Subsection 106.5. Testing deemed necessary by the Department that is in addition to the minimum testing requirements will be scheduled to minimize interference with the production schedule. The QAI will perform acceptance sampling and testing and will witness or review documentation, workmanship and testing to assure the Work is being performed in accordance with the Contract Documents.”

Under the heading, Concrete Testing, revise the first paragraph to read as the following two paragraphs:

“Concrete Testing Acceptance of structural precast units, for each day’s production, will be determined by the Department, based on compliance with this specification and satisfactory concrete testing results.

At least once per week, the QAI will make 2 concrete cylinders (6 cylinders when the Contract includes permeability requirements) for use by the Department; cylinders shall be standard cured in accordance with AASHTO T23 (ASTM C31). The QAI will perform entrained air content and slump flow testing, determine water-cement ratio and determine temperature of the sampled concrete at the time of cylinder casting. All testing equipment required by the QAI to perform this testing shall be in accordance with Standard Specification Section 502.041, Testing Equipment. In addition, the Contractor shall provide a slump cone meeting the requirements of AASHTO T 119. Providing and maintaining testing and curing equipment shall be considered incidental to the work and no additional payment will be made.

Quality Control test cylinders shall be made and tested in accordance with the following standards:

AASHTO T 22 (ASTM C39) Test Method for Compressive Strength of Cylindrical Concrete Specimens

AASHTO T23 (ASTM C31) Practice for Making and Curing Concrete Test Specimens in Field

AASHTO T141 (ASTM C172) Practice for Sampling Freshly Mixed Concrete

AASHTO T152 (ASTM C231) Test Method for Air Content of Freshly Mixed Concrete by the Pressure Method

AASHTO T196 (ASTM C173) Standard Test Method for Air Content of Freshly Mixed Concrete by the Volumetric Method

ASTM C1064 Test Method for Temperature of Freshly mixed Portland Cement Concrete

ASTM C1611 Standard Test Method for Slump Flow of Self-Consolidating Concrete”

Under the heading, Concrete Testing, delete the paragraph that begins:

“At least once per week, the Contractor shall make 2 concrete cylinders.....for use by the Department.....”

SECTION 713

STRUCTURAL STEEL AND RELATED MATERIAL

Section 713.01- Structural Steel Revise this Section by removing the sentence:

“ Impact test sampling and testing procedures shall be in accordance with AASHTO T.”

And replace it with: “**Impact test sampling and testing procedures shall be in accordance with AASHTO T 243 M/T 243 and AASHTO T 244.**”

SECTION 717 **ROADSIDE IMPROVEMENT MATERIAL**

717.02 Agricultural Ground Limestone

In the table after the third paragraph which starts with “Liquid lime...” change the Specification for Nitrogen (N) from “15.5 percent of which 1% is from ammoniac nitrogen and 14.5 /5 is from Nitrate Nitrogen” to read **“15.5 % of which 1% is from Ammoniacal Nitrogen and 14.5 % is from Nitrate Nitrogen”**

717.061 Erosion Control Blankets Revise this section by removing it in its entirety and replacing it with the following:

“717.061 Erosion Control Blankets Shall consist of a machine produced rolled blanket of biodegradable fibers, evenly distributed over the entire area of blanket, of a consistent thickness, sewn into a biodegradable mesh on the top and bottom surface using a cotton blend thread. The blanket shall remain in place when subject to shear stress of 1.55 lb/ft². The blanket shall remain intact until grass is established. The blanket shall be a product currently listed on the department’s Qualified Products List (QPL) of Erosion Control Products. See Section 618.10 - Seeding, Maintenance and Acceptance.”

SECTION 720 **STRUCTURAL SUPPORTS FOR HIGHWAY SIGNS, LUMINAIRES AND TRAFFIC SIGNALS**

720.10 Wood Utility Pole Amend the first sentence in this section by adding “, **Red Pine**” after “Douglas Fir”.

Replace the paragraph beginning with “Wood Utility poles...” with:

“Wood Utility poles shall be pressure treated, after fabrication in accordance with AASHTO Specifications M 133 and AWWA U1, UC4B, Commodity Specification D: Poles.”

720.12 Wood Sign Posts Remove the first sentence and replace with **“Wood sign posts shall be rectangular, straight and sound timber, cut from live growing native spruce, red pine, hemlock or cedar trees, free from loose knots or other structurally weakening defects of importance, such as shake or holes or heart rot.”**

Remove the paragraph beginning with “When pressure treated sign posts are called for on the plans ...” with **“When pressure treated sign posts are called for on the plans, the wood shall be Yellow Pine, Number 2 or better, or the species listed above. The pressure treated wood shall meet AASHTO M 133 and AWWA Standard U1, UC4A, Commodity Specification A: Sawn Products.”**

APPENDIX A TO DIVISION 100

SECTION 1 - BIDDING PROVISIONS

A. Federally Required Certifications By signing and delivering a Bid, the Bidder certifies as provided in all certifications set forth in this Appendix A - Federal Contract Provisions Supplement including:

- Certification Regarding No Kickbacks to Procure Contract as provided on this page 1 below.
- Certification Regarding Non-collusion as provided on page 1 below.
- Certification Regarding Non-segregated Facilities as provided by FHWA Form 1273, section III set forth on page 21 below.
- "Certification Regarding Debarment, Suspension, Ineligibility and Voluntary Exclusion" as provided by FHWA Form 1273, section XI set forth on page 32 below.
- "Certification Regarding Use of Contract Funds for Lobbying" as provided by FHWA Form 1273, section XII set forth on page 35 below.

Unless otherwise provided below, the term "Bidder", for the purposes of these certifications, includes the Bidder, its principals, and the person(s) signing the Bid. Upon execution of the Contract, the Bidder (then called the Contractor) will again make all the certifications indicated in this paragraph above.

CERTIFICATION REGARDING NO KICKBACKS TO PROCURE CONTRACT Except expressly stated by the Bidder on sheets submitted with the Bid (if any), the Bidder hereby certifies, to the best of its knowledge and belief, that it has not:

(A) employed or retained for a commission, percentage, brokerage, contingent fee, or other consideration, any firm or person (other than a bona fide employee working solely for me) to solicit or secure this contract;

(B) agreed, as an express or implied condition for obtaining this contract, to employ or retain the services of any firm or person in connection with carrying out the contract, or;

(C) paid, or agreed to pay, to any firm, organization, or person (other than a bona fide employee working solely for me) any fee, contribution, donation, or consideration of any kind for, or in connection with, procuring or carrying out the contract;

By signing and submitting a Bid, the Bidder acknowledges that this certification is to be furnished to the Maine Department of Transportation and the Federal Highway Administration, U.S. Department of Transportation in connection with this contract in anticipation of federal aid highway funds and is subject to applicable state and federal laws, both criminal and civil.

CERTIFICATION REGARDING NONCOLLUSION Under penalty of perjury as provided by federal law (28 U.S.C. §1746), the Bidder hereby certifies, to the best of its knowledge and belief, that:

the Bidder has not, either directly or indirectly, entered into any agreement, participated in any collusion, or otherwise taken any action in restraint of competitive bidding in connection with the Contract.

For a related provisions, see Section 102.7.2 (C) of the Standard Specifications - "Effects of Signing and Delivery of Bids" - "Certifications", Section 3 of this Appendix A entitled "Other Federal Requirements" including section XI - "Certification Regarding Debarment, Suspension, Ineligibility, and Voluntary Exclusion" and section XII. - "Certification Regarding Use of Contract Funds for Lobbying."

B. Bid Rigging Hotline To report bid rigging activities call: **1-800-424-9071**

The U.S. Department of Transportation (DOT) operates the above toll-free "hotline" Monday through Friday, 8:00 a.m. to 5:00 p.m., eastern time. Anyone with knowledge of possible bid rigging, bidder collusion, or other fraudulent activities should use the "hotline" to report such activities.

The "hotline" is part of the DOT's continuing effort to identify and investigate highway construction contract fraud and abuse and is operated under the direction of the DOT Inspector General. All information will be treated confidentially and caller anonymity will be respected.

SECTION 2 - FEDERAL EEO AND CIVIL RIGHTS REQUIREMENTS

Unless expressly otherwise provided in the Bid Documents, the provisions contained in this Section 2 of this "Federal Contract Provisions Supplement" are hereby incorporated into the Bid Documents and Contract.

A. Nondiscrimination & Civil Rights - Title VI The Contractor and its subcontractors shall not discriminate on the basis of race, color, national origin, or sex in the performance of this Contract. The Contractor shall carry out applicable requirements of 49 CFR Part 26 in the award and administration of DOT assisted contracts. Failure by the Contractor to carry out these requirements is a material breach of this contract, which may result in the termination of this contract or such other remedy as the Department deems appropriate. The Contractor and subcontractors shall comply with Title VI of the Civil Rights Act of 1964, as amended, and with all State of Maine and other Federal Civil Rights laws.

For related provisions, see Subsection B - "Nondiscrimination and Affirmative Action - Executive Order 11246" of this Section 2 and Section 3 - Other Federal Requirements of this "Federal Contract Provisions Supplement" including section II - "Nondiscrimination" of the "Required Contract Provisions, Federal Aid Construction Contracts", FHWA-1273.

B. Nondiscrimination and Affirmative Action - Executive Order 11246 Pursuant to Executive Order 11246, which was issued by President Johnson in 1965 and amended in 1967 and 1978, this Contract provides as follows.

The Contractor shall take specific affirmative actions to ensure equal employment opportunity. The evaluation of the Contractor's compliance with these specifications shall be based upon its efforts to achieve maximum results from its actions. The Contractor shall document these efforts fully, and shall implement affirmative action steps at least as extensive as the following:

Ensure and maintain a working environment free of harassment, intimidations, and coercion at all sites, and in all facilities at which the Contractor's employees are assigned to work. The Contractor, where possible, will assign two or more women to each construction project. The Contractor shall specifically ensure that all forepersons, superintendents, and other on-site supervisory personnel are aware of and carry out the Contractor's obligation to maintain such a working environment, with specific attention to minority or female individuals working at such sites or in such facilities.

Establish and maintain a current list of minority and female recruitment sources, provide written notification to minority and female recruitment sources and to community organizations when the Contractor or its union have employment opportunities available, and to maintain a record of the organization's responses.

Maintain a current file of the names, addresses and telephone numbers of each minority and female off-the-street applicant and minority or female referral from a union, a recruitment source or community organization and of what action was taken with respect to each such individual. If such individual was sent to the union hiring hall for referral and was not referred back to the Contractor by the union or, if referred, not employed by the Contractor, this shall be documented in the file with the reason therefore, along with whatever additional actions the Contractor may have taken.

Provide immediate written notification to the Department's Civil Rights Office when the union or unions with which the Contractor has a collective bargaining agreement has not referred to the Contractor a minority person or woman sent by the Contractor, or when the Contractor has other information that the union referral process has impeded the Design-Builder's efforts to meet its obligations.

Develop on-the-job training opportunities and/or participate in training programs for the area which expressly include minorities and women, including upgrading programs and apprenticeship and trainee programs relevant to the Contractor's employment needs, especially those programs funded or approved by the Department of Labor. The Contractor shall provide notice of these programs to the sources compiled under B above.

Disseminate the Contractor's EEO policy by providing notice of the policy to unions and training programs and requesting their cooperation in assisting the Contractor in meeting its EEO obligation; by including it in any policy manual and collective bargaining agreement; by publicizing it in the company newspaper, annual report, etc.; by specific review of the policy with all management personnel and with all minority and female employees at least once a year; and by posting the company EEO policy on bulletin boards accessible to all employees at each location where construction work is performed.

Review, at least annually, the company's EEO policy and affirmative action obligations under these specifications with all employees having any responsibility for hiring, assignment, layoff, termination, or other employment decisions including specific review of these items with on-site supervisory personnel such as Superintendents, General Forepersons, etc., prior to the initiation of construction work at any job site. A written record shall be made and maintained identifying the time and place of these meetings, persons attending, subject matter discussed, and disposition of the subject matter.

Disseminate the Contractor's EEO policy externally by including it in any advertising in the news media, specifically including minority and female news media, and providing written notification to and discussing the Contractor's EEO policy with other Contractor's and Subcontractors with whom the Contractor does or anticipates doing business.

Direct its recruitment efforts, both orally and written to minority, female and community organizations, to schools with minority and female students and to minority and female recruitment and training organizations serving the Contractor's recruitment area and employment needs. Not later than one month prior to the date for the acceptance of applications for apprenticeship or other training by any recruitment source, the Contractor shall send written notification to organizations such as the above describing the openings, screenings, procedures, and test to be used in the selection process.

Encourage present minority and female employees to recruit other minority persons and women and, where reasonable, provide after school, summer and vacation employment to minority and female youth, both on the site and in other areas of a Contractor's workforce.

Validate all tests and other selection requirements.

Conduct, at least annually, an inventory and evaluation at least of all minority and female personnel for promotional opportunities and encourage these employees to seek or to prepare for, through appropriate training, etc., such opportunities.

Ensure that seniority practices, job classifications, work assignments and other personnel practices, do not have a discriminatory effect by continually monitoring all personnel and employment related activities to ensure that the EEO policy and the Contractor's obligations under these specifications are being carried out.

Ensure that all facilities and company activities are non segregated except that separate or single-user toilet and necessary changing facilities shall be provided to assure privacy between the sexes.

Document and maintain a record of all solicitations of offers for subcontracts from minority and female construction Contractor's and suppliers, including circulation of solicitations to minority and female Contractor associations and other business associations.

Conduct a review, at least annually, of all supervisors' adherence to and performance under the Contractor's EEO policies and affirmative action obligations.

C. Goals for Employment of Women and Minorities Per Executive Order 11246, craft tradesperson goals are 6.9% women and .5% minorities employed. However, goals may be adjusted upward at the mutual agreement of the Contractor and the Department. Calculation of these percentages shall not include On-the-Job Training Program trainees, and shall not include clerical or field clerk position employees.

For a more complete presentation of requirements for such Goals, see the federally required document "Goals for Employment of Females and Minorities" set forth in the next 6 pages below.

Start of GOALS FOR EMPLOYMENT OF FEMALES AND MINORITIES
Federally Required Contract Document

§60-4.2 Solicitations

(d) The following notice shall be included in, and shall be part of, all solicitations for offers and bids on all Federal and federally assisted construction contracts or subcontracts in excess of \$10,000 to be performed in geographical areas designated by the Director pursuant to §60-4.6 of this part (see 41 CFR 60-4.2(a)):

Notice of Requirement for Affirmative Action to Ensure Equal Opportunity (Executive Order 11246)

1. The Offeror's or bidder's attention is called to the "Equal Opportunity Clause" and the "Standard Federal Equal Employment Specifications" set forth herein.
2. The goals and timetables for minority and female participation, expressed in percentage terms for the Contractor's aggregate work force in each trade on all construction work in the covered area, are as follows:

<u>Goals for female participation in each trade</u>	6.9%
---	------

Goals for minority participation for each trade

Maine

001 Bangor, ME	0.8%
----------------	------

Non-SMSA Counties (Aroostook, Hancock, Penobscot, Piscataquis, Waldo, Washington)

002 Portland-Lewiston, ME

SMSA Counties: 4243 Lewiston-Auburn, ME	0.5%
---	------

(Androscoggin)

6403 Portland, ME	0.6%
-------------------	------

(Cumberland, Sagadahoc)

Non-SMSA Counties:
(Franklin, Kennebec, Knox, Lincoln, Oxford, Somerset, York)

These goals are applicable to all the Contractor's construction work (whether or not it is Federal or federally assisted) performed in the covered area. If the contractor performs construction work in a geographical area located outside of the covered area, it shall apply the goals established for such geographical area where the work is actually performed. With regard to this second area, the contractor also is subject to the goals for both its federally involved and non federally involved construction.

The contractor's compliance with the Executive Order and the regulations in 41 CFR Part 60-4 shall be based on its implementation of the Equal Opportunity Clause, specific affirmative action obligations required by the specifications set forth in 41 CFR 60-4.3(a), and its efforts to meet the goals. The hours of minority and female employment and training must be substantially uniform throughout the length of the contract, and in each trade, and the contractor shall make a good faith effort to employ minorities and women evenly on each of its projects. The transfer of minority or female employees or trainees from Contractor to Contractor or from project to project for the sole purpose of meeting the Contractor's goals shall be in violation of the contract, the Executive Order and the regulations in 41 CFR Part 60-4. Compliance with the goals will be measured against the total work hours performed.

3. The Contractor shall provide written notification to the Director of the Office of Federal Contract Compliance Programs within 10 working days of award of any construction subcontract in excess of \$10,000 at any tier for construction work under the contract resulting from this solicitation. The notification shall list the name, address and telephone number of the subcontractor, employer identification number of the subcontractor, estimated dollar amount of the subcontract; estimated started and completion dates of the subcontract; and the geographical area in which the subcontract is to be performed.

4. As used in this Notice, and in the Contract resulting from this solicitation, the "covered area" is (insert description of the geographical areas where the contract is to be performed giving the state, county and city, if any).

STANDARD FEDERAL EQUAL EMPLOYMENT OPPORTUNITY CONSTRUCTION
CONTRACT SPECIFICATIONS (EXECUTIVE ORDER 11246)

1. As used in these specifications:
 - a. "Covered area" means the geographical area described in the solicitation from which this contract resulted;
 - b. "Director" means Director, Office of Federal Contract Compliance Programs, United States Department of Labor, or any person to whom the Director delegates authority;
 - c. "Employer identification number" means the Federal Social Security number used on the Employer's Quarterly Federal Tax Return, U.S. Treasury Department form 941;
 - d. "Minority" includes:

- (i) Black (all persons having origins in any of the Black African racial groups not of Hispanic origin);
 - (ii) Hispanic (all persons of Mexican, Puerto Rican, Cuban, Central or South American or other Spanish Culture or origin, regardless of race);
 - (iii) Asian and Pacific Islander (all persons having origins in any of the original peoples of the Far East, Southeast Asia, the Indian Subcontinent, or the Pacific Islands); and
 - (iv) American Indian or Alaskan Native (all persons having origins in any of the original peoples of the North America and maintaining identifiable tribal affiliations through membership and participation or community identification).
2. Whenever the Contractor, or any subcontractor at any tier, subcontracts a portion of the work involving any construction trade, it shall physically include in each subcontract in excess of \$10,000 the provisions of these specifications and the Notice which contains the applicable goals for minority and female participation and which is set forth in the solicitations from which this contract resulted.
3. If the contractor, is participating (pursuant to 41 CFR 60-4.5) in a Hometown Plan approved by the U.S. Department of Labor in the covered area either individually or through an association, its affirmative action obligations on all work in the Plan area (including goals and timetables) shall be in accordance with that Plan for those trades which have unions participating in the Plan. Contractors must be able to demonstrate their participation in and compliance with the provisions of any such Hometown Plan. Each Contractor or Subcontractor participating in an approved Plan is individually required to comply with its obligations under the EEO clause, and to make a good faith effort to achieve each goal under the Plan in each trade in which it has employees. The overall good faith performance by other Contractors for Subcontractors toward a goal in an approved Plan does not excuse any covered Contractor's or Subcontractor's failure to take good faith efforts to achieve the Plan goals and timetables.
4. The Contractor shall implement the specific affirmative action standards provided in paragraphs 7 a. through p. of these specifications. The goals set forth in the solicitation from which this contract resulted are expressed as percentages of the total hours of employment and training of minority and female utilization the Contractor should reasonably be able to achieve in each construction trade in which it has employees in contractors performing construction work in geographical areas where they do not have a Federal or federally assisted construction contract shall apply the minority and female goals established for the geographical areas where the work is being performed. Goals are published periodically in the Federal Register in notice form and such notices may be obtained from any Office of Federal Contract Compliance Programs office or from Federal procurement contracting officers. The Contractor is expected to make substantially uniform progress in meeting its goals in each craft during the period specific.
5. Neither the provisions of any collective bargaining agreement, nor the failure by a union with whom the Contractor has a collective bargaining agreement, to refer either minorities or women shall excuse the Contractor's obligations under these specifications, Executive Order 11246, or the regulations promulgated pursuant, thereto.

6. In order for the non working training hours of apprentices and trainees to be counted in meeting the goals, such apprentices and trainees must be employed by the Contractor during the training period, and the Contractor must have made a commitment to employ the apprentices and trainees at the completion of their training, subject to the availability of employment opportunities. Trainees must be trained pursuant to training programs approved by the U.S. Department of Labor.
7. The Contractor shall take specific affirmative actions to ensure equal employment opportunity. The evaluation of the Contractor's compliance with these specifications shall be based upon its effort to achieve maximum results from its actions. The Contractor shall document these efforts fully, and shall implement affirmative action steps at least as expensive as the following:
 - a. Ensure and maintain a working environment free of harassment, intimidation, coercion at all sites, and in all facilities at which the Contractor's employees are assigned to work. The Contractor, when possible, will assign two or more women to each construction project. The Contractor shall specifically ensure that all foremen, superintendents, and other on-site supervisory personnel are aware of and carry out the Contractor's obligation to maintain such a working environment, with specific attention to minority or female individuals working at such sites or in such facilities.
 - b. Establish and maintain a current list of minority and female recruitment sources provide written notification to minority and female recruitment sources and to community organizations when the Contractor or its unions have employment opportunities available, and maintain a record of the organization's responses.
 - c. Maintain a current file of the names, addresses and telephone numbers of each minority and female off-the-street applicant and minority or female referral from a union, a recruitment sources or community organization and of what action was taken with respect to each such individual. If such individual was sent to the union hiring hall for referral and was not referred back to the Contractor by the union or, if referred, not employed by the Contractor, this shall be documented in the file with the reason therefore, along with whatever additional actions the Contractor may have taken.
 - d. Provide immediate written notification to the Director when the union or unions with which the Contractor has a collective bargaining agreement has not referred to the Contractor a minority person or woman sent by the Contractor, or when the Contractor has other information that the union referral process has impeded the Contractor's efforts to meet its obligations.
 - e. Develop on-the-job training opportunities and/or participate in training programs for the area which expressly include minorities and women, including upgrading programs and apprenticeship and trainee programs relevant to the Contractor's employment needs, especially those programs funded or approved by the Department of Labor. The Contractor shall provide notice of these programs to the sources complied under 7b above.

- f. Disseminate the Contractor's EEO policy by providing notice of the policy to unions and training programs and requesting their cooperation in assisting the Contractor in meeting its EEO obligations; by including in any policy manual and collective bargaining agreement; by publicizing it in the company newspaper, annual report, etc.; by specific review of the policy with all management personnel and with all minority and female employees at least once a year; and by posting the company EEO policy on bulletin boards accessible to all employees at each location where construction work is performed.
- g. Review, at least annually, the company's EEO policy and affirmative action obligations under these specifications with all employees having any responsibility for hiring, assignment, layoff, termination or other employment decisions including specific review of these items with on-site supervisory personnel such as Superintendents, General Foremen, etc., prior to the initiation of construction work at any job site. A written record shall be made and maintained identifying the time and place of these meetings, persons attending, subject matter discussed, and disposition of the subject matter.
- h. Disseminate the Contractor's EEO policy externally by including it in any advertising in the news media, specifically including minority and female news media, and providing written notification to and discussing the Contractor's EEO policy with other Contractors and Subcontractors with whom the Contractor does or anticipates doing business.
- i. Direct its recruitment, efforts, both oral and written, to minority, female and community organizations, to schools with minority and female students and to minority and female recruitment and training organizations serving the Contractor's recruitment area and employment needs. Not later than one month other training by any recruitment source, the Contractor shall send written notification to organizations such as the above, describing prior to the date for the acceptance of applications for apprenticeship or the openings, screening procedures, and tests to be used in the selection process.
- j. Encourage present minority and female employees to recruit other minority persons and women and, where reasonable, provide after school, summer and vacation employment to minority and female youth both on site and in other areas of a Contractor's work force.
- k. Validate all tests and other selection requirements where there is an obligation to do so under 41 CFR Part 60-3.
- l. Conduct, at least annually, an inventory and evaluation at least of all minority and female personnel for promotional opportunities and encourage these employees to seek or to prepare for, through appropriate training, etc., such opportunities.
- m. Ensure that seniority practices, job classifications, work assignments and other personnel practices, do not have a discriminatory effect by continually monitoring all personnel and employment related activities to ensure that the EEO policy and the Contractor's obligations under these specifications are being carried out.

- n. Ensure that all facilities and company activities are non segregated except that separate or single-user toilet and necessary changing facilities shall be provided to assure privacy between the sexes.
 - o. Document and maintain a record of all solicitations of offers for subcontracts from minority and female construction contractors and suppliers, including circulation of solicitation to minority and female contractor associations and other business associations.
 - p. Conduct a review, at least annually, of all supervisor's adherence to and performance under the Contractor's EEO policies and affirmative action obligations.
8. Contractors are encouraged to participate in voluntary associations which assist in fulfilling one or more of their affirmative action obligations (7 a through p.). The efforts of a contractor association, joint contractor-union, contractor-community, or other similar group of which the contractor is a member and participant, may be asserted as fulfilling any one or more of its obligations under 7 a through p. of these specifications provided that the contractor actively participates in the group, makes every effort to assure that the group has a positive impact on the employment of minorities and women in the industry, ensures that the concrete benefits of the program and reflected in the Contractor's minority and female work force participation, makes a good faith effort to meet its individual goals and timetables, and can provide access to documentation which demonstrates the effectiveness of actions take on behalf of the Contractor. The obligation to comply, however, is the Contractor's and failure of such a group to fulfill an obligation shall not be a defense for the Contractor's noncompliance.
9. A single goal for minorities and a separate single goal for women have been established. The Contractor, however, is required to provide equal employment opportunity and to take affirmative action for all minority groups, both male and female, and all women, both minority and non-minority. Consequently, the Contractor may be in violation of the Executive Order if a particular group is employed in a substantially disparate manner (for example, specific minority group of women is underutilized.)
10. The Contractor shall not use the goals and timetables or affirmative action even though the Contractor has achieved its goals for women generally, the Contractor may be in violation of the Executive Order if standards to discriminate against any person because of race, color, religion, sex, or national origin.
11. The Contractor shall not enter into any Subcontract with any person or firm debarred from Government contracts pursuant to Executive Order 11246.
12. The Contractor shall carry out such sanctions and penalties for violation of these specifications and of the Equal Opportunity Clause, including suspension, termination and cancellation of existing subcontracts as may be imposed or ordered pursuant to Executive Order 11246, as amended, and its implementation regulations by the Office of Federal Contract Compliance Programs. Any Contractor who fails to carry out such sanctions and penalties shall be in violation of these specifications and Executive Order 11246, as amended.

13. The Contractor, in fulfilling its obligations under these specifications, shall implement specific affirmative action steps, at least as extensive as those standards prescribed in paragraph 7 of these specifications, so as to achieve maximum results from its efforts to ensure equal employment opportunity. If the Contractor fails to comply with the requirements of the Executive Order, the implementing regulations, or these specifications, the Director shall proceed in accordance with 41 CFR 60-4.6.
14. The Contractor shall designate a responsible official to monitor all employment related activity to ensure that the company EEO policy is being carried out, to submit reports relating to the provisions hereof as may be required by the Government and to keep records. Records shall at least include for each employee the name, address, telephone numbers, construction trade, union affiliation if any, employee identification number when assigned, social security number, race, sex, status (e.g. mechanic, apprentice, trainee, helper, or laborer), dates of changes in status, hours worked per week in the indicated trade, rate of pay, and location at which the work was performed. Records be maintained in an easily understandable and retrievable form; however, to the degree that existing records satisfy this requirement, contractors shall not be required to maintain separate records.
15. Nothing herein provided shall be construed as a limitation upon the application of other laws which establish different standards of compliance or upon the application of requirements for the hiring of local or other area residents (e.g., those under the Public Works Employment Act of 1977 and the Community Development Block Grant Program).

End of GOALS FOR EMPLOYMENT OF FEMALES AND MINORITIES
Federally Required Contract Document

D. Section '**D Disadvantaged Business Enterprise (DBE) Requirements**' is removed in its entirety. The DBE material is in:

Section 105.10 EQUAL OPPORTUNITY AND CIVIL RIGHTS.

SECTION 3 - OTHER FEDERAL REQUIREMENTS

Unless expressly otherwise provided in the Bid Documents, the provisions contained in this Section 3 of this "Federal Contract Provisions Supplement" are hereby incorporated into the Bid Documents and Contract.

A. Buy America

If the cost of products purchased for permanent use in this project which are manufactured of steel, iron or the application of any coating to products of these materials exceeds 0.1 percent of the contract amount, or \$2,500.00, whichever is greater, the products shall have been manufactured and the coating applied in the United States. The coating materials are not subject to this clause, only the application of the coating. In computing that amount, only the cost of the product and coating application cost will be included.

Ore, for the manufacture of steel or iron, may be from outside the United States; however, all other manufacturing processes of steel or iron must be in the United States to qualify as having been manufactured in the United States.

United States includes the 50 United States and any place subject to the jurisdiction thereof.

Products of steel include, but are not limited to, such products as structural steel, piles, guardrail, steel culverts, reinforcing steel, structural plate and steel supports for signs, luminaries and signals.

Products of iron include, but are not limited to, such products as cast iron grates.

Application of coatings include, but are not limited to, such applications as epoxy, galvanized and paint.

To assure compliance with this section, the Contractor shall submit a certification letter on its letterhead to the Department stating the following:

“This is to certify that products made of steel, iron or the application of any coating to products of these materials whose costs are in excess of \$2,500.00 or 0.1 percent of the original contract amount, whichever is greater, were manufactured and the coating, if one was required, was applied in the United States.”

B. Materials

a. Convict Produced Materials References: 23 U.S.C. 114(b)(2), 23 CFR 635.417

Applicability: FHWA's prohibition against the use of convict material only applies to Federal-aid highways. Materials produced after July 1, 1991, by convict labor may only be incorporated in a Federal-aid highway construction project if: 1) such materials have been produced by convicts who are on parole, supervised release, or probation from a prison; or 2) such material has been produced in a qualified prison facility, e.g., prison industry, with the amount produced during any 12-month period, for use in Federal-aid projects, not exceeding the amount produced, for such use, during the 12-month period ending July 1, 1987.

Materials obtained from prison facilities (e.g., prison industries) are subject to the same requirements for Federal-aid participation that are imposed upon materials acquired from other sources. Materials manufactured or produced by convict labor will be given no preferential treatment.

The preferred method of obtaining materials for a project is through normal contracting procedures which require the contractor to furnish all materials to be incorporated in the work. The contractor selects the source, public or private, from which the materials are to be obtained (23 CFR 635.407). Prison industries are prohibited from bidding on projects directly (23 CFR 635.112e), but may act as material supplier to construction contractors.

Prison materials may also be approved as State-furnished material. However, since public agencies may not bid in competition with private firms, direct acquisition of materials from a

prison industry for use as State-furnished material is subject to a public interest finding with the Division Administrator's concurrence (23 CFR 635.407d). Selection of materials produced by convict labor as State-furnished materials for mandatory use should be cleared prior to the submittal of the Plans Specifications & Estimates (PS&E).

b. Patented/Proprietary Products References: 23 U.S.C. 112, 23 CFR 635.411

FHWA will not participate, directly or indirectly, in payment for any premium or royalty on any patented or proprietary material, specification, or process specifically set forth in the plans and specifications for a project, unless:

- the item is purchased or obtained through competitive bidding with equally suitable unpatented items,
- the STA certifies either that the proprietary or patented item is essential for synchronization with the existing highway facilities or that no equally suitable alternative exists, or
- the item is used for research or for a special type of construction on relatively short sections of road for experimental purposes. States should follow FHWA's procedures for "Construction Projects Incorporating Experimental Features" ([expermnt.htm](#)) for the submittal of work plans and evaluations.

The primary purpose of the policy is to have competition in selection of materials and allow for development of new materials and products. The policy further permits materials and products that are judged equal may be bid under generic specifications. If only patented or proprietary products are acceptable, they shall be bid as alternatives with all, or at least a reasonable number of, acceptable materials or products listed; and the Division Administrator may approve a single source if it can be found that its utilization is in the public interest.

Trade names are generally the key to identifying patented or proprietary materials. Trade name examples include 3M, Corten, etc. Generally, products identified by their brand or trade name are not to be specified without an "or equal" phrase, and, if trade names are used, all, or at least a reasonable number of acceptable "equal" materials or products should be listed. The licensing of several suppliers to produce a product does not change the fact that it is a single product and should not be specified to the exclusion of other equally suitable products.

c. State Preference References: 23 U.S.C. 112, 23 CFR 635.409

Materials produced within Maine shall not be favored to the exclusion of comparable materials produced outside of Maine. State preference clauses give particular advantage to the designated source and thus restrict competition. Therefore, State preference provisions shall not be used on any Federal-aid construction projects.

This policy also applies to State preference actions against materials of foreign origin, except as otherwise permitted by Federal law. Thus, States cannot give preference to in-State material sources over foreign material sources. Under the Buy America provisions, the States are

permitted to expand the Buy America restrictions provided that the STA is legally authorized under State law to impose more stringent requirements.

d. State Owned/Furnished/Designated Materials References: 23 U.S.C. 112, 23 CFR 635.407

Current FHWA policy requires that the contractor must furnish all materials to be incorporated in the work, and the contractor shall be permitted to select the sources from which the materials are to be obtained. Exceptions to this requirement may be made when there is a definite finding, by MaineDOT and concurred in by Federal Highway Administration's (FHWA) Division Administrator, that it is in the public interest to require the contractor to use materials furnished by the MaineDOT or from sources designated by MaineDOT. The exception policy can best be understood by separating State-furnished materials into the categories of manufactured materials and local natural materials.

Manufactured Materials When the use of State-furnished manufactured materials is approved based on a public interest finding, such use must be made mandatory. The optional use of State-furnished manufactured materials is in violation of our policy prohibiting public agencies from competing with private firms. Manufactured materials to be furnished by MaineDOT must be acquired through competitive bidding, unless there is a public interest finding for another method, and concurred in by FHWA's Division Administrator.

Local Natural Materials When MaineDOT owns or controls a local natural materials source such as a borrow pit or a stockpile of salvaged pavement material, etc., the materials may be designated for either optional or mandatory use; however, mandatory use will require a public interest finding (PIF) and FHWA's Division Administrator's concurrence.

In order to permit prospective bidders to properly prepare their bids, the location, cost, and any conditions to be met for obtaining materials that are made available to the contractor shall be stated in the bidding documents.

Mandatory Disposal Sites Normally, the disposal site for surplus excavated materials is to be of the contractor's choosing; although, an optional site(s) may be shown in the contract provisions. A mandatory site shall be specified when there is a finding by MaineDOT, with the concurrence of the Division Administrator, that such placement is the most economical or that the environment would be substantially enhanced without excessive cost. Discussion of the mandatory use of a disposal site in the environmental document may serve as the basis for the public interest finding.

Summarizing FHWA policy for the mandatory use of borrow or disposal sites:

- mandatory use of either requires a public interest finding and FHWA's Division Administrator's concurrence,
- mandatory use of either may be based on environmental consideration where the environment will be substantially enhanced without excessive additional cost, and
- where the use is based on environmental considerations, the discussion in the environmental document may be used as the basis for the public interest finding.

Factors to justify a public interest finding should include such items as cost effectiveness, system integrity, and local shortages of material.

C. Standard FHWA Contract Provisions - FHWA 1273

Unless expressly otherwise provided in the Bid Documents, the following “Required Contract Provisions, Federal Aid Construction Contracts”, FHWA-1273, are hereby incorporated into the Bid Documents and Contract.

Cargo Preference Act : Contractor and Subcontractor Clauses. “Use of United States-flag vessels: The contractor agrees—“(1) To utilize privately owned United States-flag commercial vessels to ship at least 50 percent of the gross tonnage (computed separately for dry bulk carriers, dry cargo liners, and tankers) involved, whenever shipping any equipment, material, or commodities pursuant to this contract, to the extent such vessels are available at fair and reasonable rates for United States-flag commercial vessels.”(2) To furnish within 20 days following the date of loading for shipments originating within the United States or within 30 working days following the date of loading for shipments originating outside the United States, a legible copy of a rated, ‘on-board’ commercial ocean bill-of-lading in English for each shipment of cargo described in paragraph (1) of this section to both the Contracting Officer (through the prime contractor in the case of subcontractor bills-of-lading) and to the Division of National Cargo, Office of Market Development, Maritime Administration, Washington, DC 20590.”(3) To insert the substance of the provisions of this clause in all subcontracts issued pursuant to this contract.”(Reorganization Plans No. 21 of 1950 (64 Stat. 1273) and No. 7 of 1961 (75 Stat. 840) as amended by Pub. L. 91-469 (84 Stat. 1036) and Department of Commerce Organization Order 10-8 (38 FR 19707, July 23, 1973)) [42 FR 57126, Nov. 1, 1977]

The Cargo Preference Act requirements apply to materials or equipment that are acquired for a specific Federal-aid highway project. In general, the requirements are not applicable to goods or materials that come into inventories independent of an FHWA funded-contract. For example, the requirements would not apply to shipments of Portland cement, asphalt cement, or aggregates, as industry suppliers and contractors use these materials to replenish existing inventories. In general, most of the materials used for highway construction originate from existing inventories and are not acquired solely for a specific Federal-aid project. However, if materials or equipment are acquired solely for a Federal-aid project, then the Cargo Preference Act requirements apply.”

Start of FHWA 1273 REQUIRED CONTRACT PROVISIONS
FEDERAL-AID CONSTRUCTION CONTRACTS (As revised through May 1, 2012)

FHWA-1273 -- Revised May 1, 2012

**REQUIRED CONTRACT PROVISIONS
FEDERAL-AID CONSTRUCTION CONTRACTS**

- I. General
- II. Nondiscrimination
- III. Nonsegregated Facilities
- IV. Davis-Bacon and Related Act Provisions
- V. Contract Work Hours and Safety Standards Act Provisions
- VI. Subletting or Assigning the Contract
- VII. Safety: Accident Prevention
- VIII. False Statements Concerning Highway Projects
- IX. Implementation of Clean Air Act and Federal Water Pollution Control Act
- X. Compliance with Governmentwide Suspension and Debarment Requirements
- XI. Certification Regarding Use of Contract Funds for Lobbying

ATTACHMENTS

A. Employment and Materials Preference for Appalachian Development Highway System or Appalachian Local Access Road Contracts (included in Appalachian contracts only)

I. GENERAL

1. Form FHWA-1273 must be physically incorporated in each construction contract funded under Title 23 (excluding emergency contracts solely intended for debris removal). The contractor (or subcontractor) must insert this form in each subcontract and further require its inclusion in all lower tier subcontracts (excluding purchase orders, rental agreements and other agreements for supplies or services).

The applicable requirements of Form FHWA-1273 are incorporated by reference for work done under any purchase order, rental agreement or agreement for other services. The prime contractor shall be responsible for compliance by any subcontractor, lower-tier subcontractor or service provider.

Form FHWA-1273 must be included in all Federal-aid design-build contracts, in all subcontracts and in lower tier subcontracts (excluding subcontracts for design services, purchase orders, rental agreements and other agreements for supplies or services). The design-builder shall be responsible for compliance by any subcontractor, lower-tier subcontractor or service provider.

Contracting agencies may reference Form FHWA-1273 in bid proposal or request for proposal documents, however, the Form FHWA-1273 must be physically incorporated (not referenced) in all contracts, subcontracts and lower-tier subcontracts (excluding purchase orders, rental agreements and other agreements for supplies or services related to a construction contract).

2. Subject to the applicability criteria noted in the following sections, these contract provisions shall apply to all work performed on the contract by the contractor's own organization and with the assistance of workers under the contractor's immediate superintendence and to all work performed on the contract by piecework, station work, or by subcontract.

3. A breach of any of the stipulations contained in these Required Contract Provisions may be sufficient grounds for withholding of progress payments, withholding of final payment,

termination of the contract, suspension / debarment or any other action determined to be appropriate by the contracting agency and FHWA.

4. Selection of Labor: During the performance of this contract, the contractor shall not use convict labor for any purpose within the limits of a construction project on a Federal-aid highway unless it is labor performed by convicts who are on parole, supervised release, or probation. The term Federal-aid highway does not include roadways functionally classified as local roads or rural minor collectors.

II. NONDISCRIMINATION

The provisions of this section related to 23 CFR Part 230 are applicable to all Federal-aid construction contracts and to all related construction subcontracts of \$10,000 or more. The provisions of 23 CFR Part 230 are not applicable to material supply, engineering, or architectural service contracts.

In addition, the contractor and all subcontractors must comply with the following policies: Executive Order 11246, 41 CFR 60, 29 CFR 1625-1627, Title 23 USC Section 140, the Rehabilitation Act of 1973, as amended (29 USC 794), Title VI of the Civil Rights Act of 1964, as amended, and related regulations including 49 CFR Parts 21, 26 and 27; and 23 CFR Parts 200, 230, and 633.

The contractor and all subcontractors must comply with: the requirements of the Equal Opportunity Clause in 41 CFR 60-1.4(b) and, for all construction contracts exceeding \$10,000, the Standard Federal Equal Employment Opportunity Construction Contract Specifications in 41 CFR 60-4.3.

Note: The U.S. Department of Labor has exclusive authority to determine compliance with Executive Order 11246 and the policies of the Secretary of Labor including 41 CFR 60, and 29 CFR 1625-1627. The contracting agency and the FHWA have the authority and the responsibility to ensure compliance with Title 23 USC Section 140, the Rehabilitation Act of 1973, as amended (29 USC 794), and Title VI of the Civil Rights Act of 1964, as amended, and related regulations including 49 CFR Parts 21, 26 and 27; and 23 CFR Parts 200, 230, and 633.

The following provision is adopted from 23 CFR 230, Appendix A, with appropriate revisions to conform to the U.S. Department of Labor (US DOL) and FHWA requirements.

1. Equal Employment Opportunity: Equal employment opportunity (EEO) requirements not to discriminate and to take affirmative action to assure equal opportunity as set forth under laws, executive orders, rules, regulations (28 CFR 35, 29 CFR 1630, 29 CFR 1625-1627, 41 CFR 60 and 49 CFR 27) and orders of the Secretary of Labor as modified by the provisions prescribed herein, and imposed pursuant to 23 U.S.C. 140 shall constitute the EEO and specific affirmative action standards for the contractor's project activities under this contract. The provisions of the Americans with Disabilities Act of 1990 (42 U.S.C. 12101 et seq.) set forth under 28 CFR 35 and 29 CFR 1630 are incorporated by reference in this contract. In the execution of this contract, the contractor agrees to comply with the following minimum specific requirement activities of EEO:

a. The contractor will work with the contracting agency and the Federal Government to ensure that it has made every good faith effort to provide equal opportunity with respect to all of its terms and conditions of employment and in their review of activities under the contract.

b. The contractor will accept as its operating policy the following statement:

"It is the policy of this Company to assure that applicants are employed, and that employees are treated during employment, without regard to their race, religion, sex, color, national origin, age or disability. Such action shall include: employment, upgrading, demotion, or transfer; recruitment or recruitment advertising; layoff or termination; rates of pay or other forms of compensation; and selection for training, including apprenticeship, pre-apprenticeship, and/or on-the-job training."

2. EEO Officer: The contractor will designate and make known to the contracting officers an EEO Officer who will have the responsibility for and must be capable of effectively administering and promoting an active EEO program and who must be assigned adequate authority and responsibility to do so.

3. Dissemination of Policy: All members of the contractor's staff who are authorized to hire, supervise, promote, and discharge employees, or who recommend such action, or who are substantially involved in such action, will be made fully cognizant of, and will implement, the contractor's EEO policy and contractual responsibilities to provide EEO in each grade and classification of employment. To ensure that the above agreement will be met, the following actions will be taken as a minimum:

a. Periodic meetings of supervisory and personnel office employees will be conducted before the start of work and then not less often than once every six months, at which time the contractor's EEO policy and its implementation will be reviewed and explained. The meetings will be conducted by the EEO Officer.

b. All new supervisory or personnel office employees will be given a thorough indoctrination by the EEO Officer, covering all major aspects of the contractor's EEO obligations within thirty days following their reporting for duty with the contractor.

c. All personnel who are engaged in direct recruitment for the project will be instructed by the EEO Officer in the contractor's procedures for locating and hiring minorities and women.

d. Notices and posters setting forth the contractor's EEO policy will be placed in areas readily accessible to employees, applicants for employment and potential employees.

e. The contractor's EEO policy and the procedures to implement such policy will be brought to the attention of employees by means of meetings, employee handbooks, or other appropriate means.

4. Recruitment: When advertising for employees, the contractor will include in all advertisements for employees the notation: "An Equal Opportunity Employer." All such advertisements will be placed in publications having a large circulation among minorities and women in the area from which the project work force would normally be derived.

- a. The contractor will, unless precluded by a valid bargaining agreement, conduct systematic and direct recruitment through public and private employee referral sources likely to yield qualified minorities and women. To meet this requirement, the contractor will identify sources of potential minority group employees, and establish with such identified sources procedures whereby minority and women applicants may be referred to the contractor for employment consideration.
- b. In the event the contractor has a valid bargaining agreement providing for exclusive hiring hall referrals, the contractor is expected to observe the provisions of that agreement to the extent that the system meets the contractor's compliance with EEO contract provisions. Where implementation of such an agreement has the effect of discriminating against minorities or women, or obligates the contractor to do the same, such implementation violates Federal nondiscrimination provisions.
- c. The contractor will encourage its present employees to refer minorities and women as applicants for employment. Information and procedures with regard to referring such applicants will be discussed with employees.

5. Personnel Actions: Wages, working conditions, and employee benefits shall be established and administered, and personnel actions of every type, including hiring, upgrading, promotion, transfer, demotion, layoff, and termination, shall be taken without regard to race, color, religion, sex, national origin, age or disability.

The following procedures shall be followed:

- a. The contractor will conduct periodic inspections of project sites to insure that working conditions and employee facilities do not indicate discriminatory treatment of project site personnel.
- b. The contractor will periodically evaluate the spread of wages paid within each classification to determine any evidence of discriminatory wage practices.
- c. The contractor will periodically review selected personnel actions in depth to determine whether there is evidence of discrimination. Where evidence is found, the contractor will promptly take corrective action. If the review indicates that the discrimination may extend beyond the actions reviewed, such corrective action shall include all affected persons.
- d. The contractor will promptly investigate all complaints of alleged discrimination made to the contractor in connection with its obligations under this contract, will attempt to resolve such complaints, and will take appropriate corrective action within a reasonable time. If the investigation indicates that the discrimination may affect persons other than the complainant, such corrective action shall include such other persons. Upon completion of each investigation, the contractor will inform every complainant of all of their avenues of appeal.

6. Training and Promotion:

a. The contractor will assist in locating, qualifying, and increasing the skills of minorities and women who are applicants for employment or current employees. Such efforts should be aimed at developing full journey level status employees in the type of trade or job classification involved.

b. Consistent with the contractor's work force requirements and as permissible under Federal and State regulations, the contractor shall make full use of training programs, i.e., apprenticeship, and on-the-job training programs for the geographical area of contract performance. In the event a special provision for training is provided under this contract, this subparagraph will be superseded as indicated in the special provision. The contracting agency may reserve training positions for persons who receive welfare assistance in accordance with 23 U.S.C. 140(a).

c. The contractor will advise employees and applicants for employment of available training programs and entrance requirements for each.

d. The contractor will periodically review the training and promotion potential of employees who are minorities and women and will encourage eligible employees to apply for such training and promotion.

7. Unions: If the contractor relies in whole or in part upon unions as a source of employees, the contractor will use good faith efforts to obtain the cooperation of such unions to increase opportunities for minorities and women.

Actions by the contractor, either directly or through a contractor's association acting as agent, will include the procedures set forth below:

a. The contractor will use good faith efforts to develop, in cooperation with the unions, joint training programs aimed toward qualifying more minorities and women for membership in the unions and increasing the skills of minorities and women so that they may qualify for higher paying employment.

b. The contractor will use good faith efforts to incorporate an EEO clause into each union agreement to the end that such union will be contractually bound to refer applicants without regard to their race, color, religion, sex, national origin, age or disability.

c. The contractor is to obtain information as to the referral practices and policies of the labor union except that to the extent such information is within the exclusive possession of the labor union and such labor union refuses to furnish such information to the contractor, the contractor shall so certify to the contracting agency and shall set forth what efforts have been made to obtain such information.

d. In the event the union is unable to provide the contractor with a reasonable flow of referrals within the time limit set forth in the collective bargaining agreement, the contractor will, through independent recruitment efforts, fill the employment vacancies without regard to race, color, religion, sex, national origin, age or disability; making full efforts to obtain qualified and/or qualifiable minorities and women. The failure of a union to provide sufficient referrals (even

though it is obligated to provide exclusive referrals under the terms of a collective bargaining agreement) does not relieve the contractor from the requirements of this paragraph. In the event the union referral practice prevents the contractor from meeting the obligations pursuant to Executive Order 11246, as amended, and these special provisions, such contractor shall immediately notify the contracting agency.

8. Reasonable Accommodation for Applicants / Employees with Disabilities: The contractor must be familiar with the requirements for and comply with the Americans with Disabilities Act and all rules and regulations established there under. Employers must provide reasonable accommodation in all employment activities unless to do so would cause an undue hardship.

9. Selection of Subcontractors, Procurement of Materials and Leasing of Equipment: The contractor shall not discriminate on the grounds of race, color, religion, sex, national origin, age or disability in the selection and retention of subcontractors, including procurement of materials and leases of equipment. The contractor shall take all necessary and reasonable steps to ensure nondiscrimination in the administration of this contract.

a. The contractor shall notify all potential subcontractors and suppliers and lessors of their EEO obligations under this contract.

b. The contractor will use good faith efforts to ensure subcontractor compliance with their EEO obligations.

10. Assurance Required by 49 CFR 26.13(b):

a. The requirements of 49 CFR Part 26 and the State DOT's U.S. DOT-approved DBE program are incorporated by reference.

b. The contractor or subcontractor shall not discriminate on the basis of race, color, national origin, or sex in the performance of this contract. The contractor shall carry out applicable requirements of 49 CFR Part 26 in the award and administration of DOT-assisted contracts. Failure by the contractor to carry out these requirements is a material breach of this contract, which may result in the termination of this contract or such other remedy as the contracting agency deems appropriate.

11. Records and Reports: The contractor shall keep such records as necessary to document compliance with the EEO requirements. Such records shall be retained for a period of three years following the date of the final payment to the contractor for all contract work and shall be available at reasonable times and places for inspection by authorized representatives of the contracting agency and the FHWA.

a. The records kept by the contractor shall document the following:

(1) The number and work hours of minority and non-minority group members and women employed in each work classification on the project;

(2) The progress and efforts being made in cooperation with unions, when applicable, to increase employment opportunities for minorities and women; and

(3) The progress and efforts being made in locating, hiring, training, qualifying, and upgrading minorities and women;

b. The contractors and subcontractors will submit an annual report to the contracting agency each July for the duration of the project, indicating the number of minority, women, and non-minority group employees currently engaged in each work classification required by the contract work. This information is to be reported on [Form FHWA-1391](#). The staffing data should represent the project work force on board in all or any part of the last payroll period preceding the end of July. If on-the-job training is being required by special provision, the contractor will be required to collect and report training data. The employment data should reflect the work force on board during all or any part of the last payroll period preceding the end of July.

III. NONSEGREGATED FACILITIES

This provision is applicable to all Federal-aid construction contracts and to all related construction subcontracts of \$10,000 or more.

The contractor must ensure that facilities provided for employees are provided in such a manner that segregation on the basis of race, color, religion, sex, or national origin cannot result. The contractor may neither require such segregated use by written or oral policies nor tolerate such use by employee custom. The contractor's obligation extends further to ensure that its employees are not assigned to perform their services at any location, under the contractor's control, where the facilities are segregated. The term "facilities" includes waiting rooms, work areas, restaurants and other eating areas, time clocks, restrooms, washrooms, locker rooms, and other storage or dressing areas, parking lots, drinking fountains, recreation or entertainment areas, transportation, and housing provided for employees. The contractor shall provide separate or single-user restrooms and necessary dressing or sleeping areas to assure privacy between sexes.

IV. DAVIS-BACON AND RELATED ACT PROVISIONS

This section is applicable to all Federal-aid construction projects exceeding \$2,000 and to all related subcontracts and lower-tier subcontracts (regardless of subcontract size). The requirements apply to all projects located within the right-of-way of a roadway that is functionally classified as Federal-aid highway. This excludes roadways functionally classified as local roads or rural minor collectors, which are exempt. Contracting agencies may elect to apply these requirements to other projects.

The following provisions are from the U.S. Department of Labor regulations in 29 CFR 5.5 "Contract provisions and related matters" with minor revisions to conform to the FHWA-1273 format and FHWA program requirements.

1. Minimum wages

a. All laborers and mechanics employed or working upon the site of the work, will be paid unconditionally and not less often than once a week, and without subsequent deduction or rebate on any account (except such payroll deductions as are permitted by regulations issued by the Secretary of Labor under the Copeland Act (29 CFR part 3)), the full amount of wages and bona fide fringe benefits (or cash equivalents thereof) due at time of payment computed at rates not less than those contained in the wage determination of the Secretary of Labor which is attached hereto and made a part hereof, regardless of any contractual relationship which may be alleged to exist between the contractor and such laborers and mechanics.

Contributions made or costs reasonably anticipated for bona fide fringe benefits under section 1(b)(2) of the Davis-Bacon Act on behalf of laborers or mechanics are considered wages paid to such laborers or mechanics, subject to the provisions of paragraph 1.d. of this section; also, regular contributions made or costs incurred for more than a weekly period (but not less often than quarterly) under plans, funds, or programs which cover the particular weekly period, are deemed to be constructively made or incurred during such weekly period. Such laborers and mechanics shall be paid the appropriate wage rate and fringe benefits on the wage determination for the classification of work actually performed, without regard to skill, except as provided in 29 CFR 5.5(a)(4). Laborers or mechanics performing work in more than one classification may be compensated at the rate specified for each classification for the time actually worked therein: Provided, That the employer's payroll records accurately set forth the time spent in each classification in which work is performed. The wage determination (including any additional classification and wage rates conformed under paragraph 1.b. of this section) and the Davis-Bacon poster (WH-1321) shall be posted at all times by the contractor and its subcontractors at the site of the work in a prominent and accessible place where it can be easily seen by the workers.

b. (1) The contracting officer shall require that any class of laborers or mechanics, including helpers, which is not listed in the wage determination and which is to be employed under the contract shall be classified in conformance with the wage determination. The contracting officer shall approve an additional classification and wage rate and fringe benefits therefore only when the following criteria have been met:

- (i) The work to be performed by the classification requested is not performed by a classification in the wage determination; and
- (ii) The classification is utilized in the area by the construction industry; and
- (iii) The proposed wage rate, including any bona fide fringe benefits, bears a reasonable relationship to the wage rates contained in the wage determination.

(2) If the contractor and the laborers and mechanics to be employed in the classification (if known), or their representatives, and the contracting officer agree on the classification and wage rate (including the amount designated for fringe benefits where appropriate), a report of the action taken shall be sent by the contracting officer to the Administrator of the Wage and Hour Division, Employment Standards Administration, U.S. Department of Labor, Washington, DC 20210. The Administrator, or an authorized representative, will approve, modify, or disapprove every additional classification action within 30 days of receipt and so advise the contracting officer or will notify the contracting officer within the 30-day period that additional time is necessary.

(3) In the event the contractor, the laborers or mechanics to be employed in the classification or their representatives, and the contracting officer do not agree on the proposed classification and wage rate (including the amount designated for fringe benefits, where appropriate), the contracting officer shall refer the questions, including the views of all interested parties and the recommendation of the contracting officer, to the Wage and Hour Administrator for determination. The Wage and Hour Administrator, or an authorized representative, will issue a determination within 30 days of receipt and so advise the contracting officer or will notify the contracting officer within the 30-day period that additional time is necessary.

(4) The wage rate (including fringe benefits where appropriate) determined pursuant to paragraphs 1.b.(2) or 1.b.(3) of this section, shall be paid to all workers performing work in the classification under this contract from the first day on which work is performed in the classification.

c. Whenever the minimum wage rate prescribed in the contract for a class of laborers or mechanics includes a fringe benefit which is not expressed as an hourly rate, the contractor shall either pay the benefit as stated in the wage determination or shall pay another bona fide fringe benefit or an hourly cash equivalent thereof.

d. If the contractor does not make payments to a trustee or other third person, the contractor may consider as part of the wages of any laborer or mechanic the amount of any costs reasonably anticipated in providing bona fide fringe benefits under a plan or program, Provided, That the Secretary of Labor has found, upon the written request of the contractor, that the applicable standards of the Davis-Bacon Act have been met. The Secretary of Labor may require the contractor to set aside in a separate account assets for the meeting of obligations under the plan or program.

2. Withholding

The contracting agency shall upon its own action or upon written request of an authorized representative of the Department of Labor, withhold or cause to be withheld from the contractor under this contract, or any other Federal contract with the same prime contractor, or any other federally-assisted contract subject to Davis-Bacon prevailing wage requirements, which is held by the same prime contractor, so much of the accrued payments or advances as may be considered necessary to pay laborers and mechanics, including apprentices, trainees, and helpers, employed by the contractor or any subcontractor the full amount of wages required by the contract. In the event of failure to pay any laborer or mechanic, including any apprentice, trainee, or helper, employed or working on the site of the work, all or part of the wages required by the contract, the contracting agency may, after written notice to the contractor, take such action as may be necessary to cause the suspension of any further payment, advance, or guarantee of funds until such violations have ceased.

3. Payrolls and basic records

a. Payrolls and basic records relating thereto shall be maintained by the contractor during the course of the work and preserved for a period of three years thereafter for all laborers and mechanics working at the site of the work. Such records shall contain the name, address, and social security number of each such worker, his or her correct classification, hourly rates of wages paid (including rates of contributions or costs anticipated for bona fide fringe benefits or cash equivalents thereof of the types described in section 1(b)(2)(B) of the Davis-Bacon Act),

daily and weekly number of hours worked, deductions made and actual wages paid. Whenever the Secretary of Labor has found under 29 CFR 5.5(a)(1)(iv) that the wages of any laborer or mechanic include the amount of any costs reasonably anticipated in providing benefits under a plan or program described in section 1(b)(2)(B) of the Davis-Bacon Act, the contractor shall maintain records which show that the commitment to provide such benefits is enforceable, that the plan or program is financially responsible, and that the plan or program has been communicated in writing to the laborers or mechanics affected, and records which show the costs anticipated or the actual cost incurred in providing such benefits. Contractors employing apprentices or trainees under approved programs shall maintain written evidence of the registration of apprenticeship programs and certification of trainee programs, the registration of the apprentices and trainees, and the ratios and wage rates prescribed in the applicable programs.

b. (1) The contractor shall submit weekly for each week in which any contract work is performed a copy of all payrolls to the contracting agency. The payrolls submitted shall set out accurately and completely all of the information required to be maintained under 29 CFR 5.5(a)(3)(i), except that full social security numbers and home addresses shall not be included on weekly transmittals. Instead the payrolls shall only need to include an individually identifying number for each employee (e.g. , the last four digits of the employee's social security number). The required weekly payroll information may be submitted in any form desired. Optional Form WH-347 is available for this purpose from the Wage and Hour Division Web site at <http://www.dol.gov/esa/whd/forms/wh347instr.htm> or its successor site. The prime contractor is responsible for the submission of copies of payrolls by all subcontractors. Contractors and subcontractors shall maintain the full social security number and current address of each covered worker, and shall provide them upon request to the contracting agency for transmission to the State DOT, the FHWA or the Wage and Hour Division of the Department of Labor for purposes of an investigation or audit of compliance with prevailing wage requirements. It is not a violation of this section for a prime contractor to require a subcontractor to provide addresses and social security numbers to the prime contractor for its own records, without weekly submission to the contracting agency..

(2) Each payroll submitted shall be accompanied by a "Statement of Compliance," signed by the contractor or subcontractor or his or her agent who pays or supervises the payment of the persons employed under the contract and shall certify the following:

(i) That the payroll for the payroll period contains the information required to be provided under §5.5 (a)(3)(ii) of Regulations, 29 CFR part 5, the appropriate information is being maintained under §5.5 (a)(3)(i) of Regulations, 29 CFR part 5, and that such information is correct and complete;

(ii) That each laborer or mechanic (including each helper, apprentice, and trainee) employed on the contract during the payroll period has been paid the full weekly wages earned, without rebate, either directly or indirectly, and that no deductions have been made either directly or indirectly from the full wages earned, other than permissible deductions as set forth in Regulations, 29 CFR part 3;

(iii) That each laborer or mechanic has been paid not less than the applicable wage rates and fringe benefits or cash equivalents for the classification of work performed, as specified in the applicable wage determination incorporated into the contract.

(3) The weekly submission of a properly executed certification set forth on the reverse side of Optional Form WH-347 shall satisfy the requirement for submission of the “Statement of Compliance” required by paragraph 3.b.(2) of this section.

(4) The falsification of any of the above certifications may subject the contractor or subcontractor to civil or criminal prosecution under section 1001 of title 18 and section 231 of title 31 of the United States Code.

c. The contractor or subcontractor shall make the records required under paragraph 3.a. of this section available for inspection, copying, or transcription by authorized representatives of the contracting agency, the State DOT, the FHWA, or the Department of Labor, and shall permit such representatives to interview employees during working hours on the job. If the contractor or subcontractor fails to submit the required records or to make them available, the FHWA may, after written notice to the contractor, the contracting agency or the State DOT, take such action as may be necessary to cause the suspension of any further payment, advance, or guarantee of funds. Furthermore, failure to submit the required records upon request or to make such records available may be grounds for debarment action pursuant to 29 CFR 5.12.

4. Apprentices and trainees

a. Apprentices (programs of the USDOL).

Apprentices will be permitted to work at less than the predetermined rate for the work they performed when they are employed pursuant to and individually registered in a bona fide apprenticeship program registered with the U.S. Department of Labor, Employment and Training Administration, Office of Apprenticeship Training, Employer and Labor Services, or with a State Apprenticeship Agency recognized by the Office, or if a person is employed in his or her first 90 days of probationary employment as an apprentice in such an apprenticeship program, who is not individually registered in the program, but who has been certified by the Office of Apprenticeship Training, Employer and Labor Services or a State Apprenticeship Agency (where appropriate) to be eligible for probationary employment as an apprentice.

The allowable ratio of apprentices to journeymen on the job site in any craft classification shall not be greater than the ratio permitted to the contractor as to the entire work force under the registered program. Any worker listed on a payroll at an apprentice wage rate, who is not registered or otherwise employed as stated above, shall be paid not less than the applicable wage rate on the wage determination for the classification of work actually performed. In addition, any apprentice performing work on the job site in excess of the ratio permitted under the registered program shall be paid not less than the applicable wage rate on the wage determination for the work actually performed. Where a contractor is performing construction on a project in a locality other than that in which its program is registered, the ratios and wage rates (expressed in percentages of the journeyman's hourly rate) specified in the contractor's or subcontractor's registered program shall be observed.

Every apprentice must be paid at not less than the rate specified in the registered program for the apprentice's level of progress, expressed as a percentage of the journeymen hourly rate specified in the applicable wage determination. Apprentices shall be paid fringe benefits in accordance with the provisions of the apprenticeship program. If the apprenticeship program does not specify fringe benefits, apprentices must be paid the full amount of fringe benefits listed on the wage determination for the applicable classification. If the Administrator determines that a

different practice prevails for the applicable apprentice classification, fringes shall be paid in accordance with that determination.

In the event the Office of Apprenticeship Training, Employer and Labor Services, or a State Apprenticeship Agency recognized by the Office, withdraws approval of an apprenticeship program, the contractor will no longer be permitted to utilize apprentices at less than the applicable predetermined rate for the work performed until an acceptable program is approved.

b. Trainees (programs of the USDOL).

Except as provided in 29 CFR 5.16, trainees will not be permitted to work at less than the predetermined rate for the work performed unless they are employed pursuant to and individually registered in a program which has received prior approval, evidenced by formal certification by the U.S. Department of Labor, Employment and Training Administration.

The ratio of trainees to journeymen on the job site shall not be greater than permitted under the plan approved by the Employment and Training Administration.

Every trainee must be paid at not less than the rate specified in the approved program for the trainee's level of progress, expressed as a percentage of the journeyman hourly rate specified in the applicable wage determination. Trainees shall be paid fringe benefits in accordance with the provisions of the trainee program. If the trainee program does not mention fringe benefits, trainees shall be paid the full amount of fringe benefits listed on the wage determination unless the Administrator of the Wage and Hour Division determines that there is an apprenticeship program associated with the corresponding journeyman wage rate on the wage determination which provides for less than full fringe benefits for apprentices. Any employee listed on the payroll at a trainee rate who is not registered and participating in a training plan approved by the Employment and Training Administration shall be paid not less than the applicable wage rate on the wage determination for the classification of work actually performed. In addition, any trainee performing work on the job site in excess of the ratio permitted under the registered program shall be paid not less than the applicable wage rate on the wage determination for the work actually performed.

In the event the Employment and Training Administration withdraws approval of a training program, the contractor will no longer be permitted to utilize trainees at less than the applicable predetermined rate for the work performed until an acceptable program is approved.

c. Equal employment opportunity. The utilization of apprentices, trainees and journeymen under this part shall be in conformity with the equal employment opportunity requirements of Executive Order 11246, as amended, and 29 CFR part 30.

d. Apprentices and Trainees (programs of the U.S. DOT).

Apprentices and trainees working under apprenticeship and skill training programs which have been certified by the Secretary of Transportation as promoting EEO in connection with Federal-aid highway construction programs are not subject to the requirements of paragraph 4 of this Section IV. The straight time hourly wage rates for apprentices and trainees under such programs will be established by the particular programs. The ratio of apprentices and trainees to journeymen shall not be greater than permitted by the terms of the particular program.

5. Compliance with Copeland Act requirements. The contractor shall comply with the requirements of 29 CFR part 3, which are incorporated by reference in this contract.

6. Subcontracts. The contractor or subcontractor shall insert Form FHWA-1273 in any subcontracts and also require the subcontractors to include Form FHWA-1273 in any lower tier subcontracts. The prime contractor shall be responsible for the compliance by any subcontractor or lower tier subcontractor with all the contract clauses in 29 CFR 5.5.

7. Contract termination: debarment. A breach of the contract clauses in 29 CFR 5.5 may be grounds for termination of the contract, and for debarment as a contractor and a subcontractor as provided in 29 CFR 5.12.

8. Compliance with Davis-Bacon and Related Act requirements. All rulings and interpretations of the Davis-Bacon and Related Acts contained in 29 CFR parts 1, 3, and 5 are herein incorporated by reference in this contract.

9. Disputes concerning labor standards. Disputes arising out of the labor standards provisions of this contract shall not be subject to the general disputes clause of this contract. Such disputes shall be resolved in accordance with the procedures of the Department of Labor set forth in 29 CFR parts 5, 6, and 7. Disputes within the meaning of this clause include disputes between the contractor (or any of its subcontractors) and the contracting agency, the U.S. Department of Labor, or the employees or their representatives.

10. Certification of eligibility.

a. By entering into this contract, the contractor certifies that neither it (nor he or she) nor any person or firm who has an interest in the contractor's firm is a person or firm ineligible to be awarded Government contracts by virtue of section 3(a) of the Davis-Bacon Act or 29 CFR 5.12(a)(1).

b. No part of this contract shall be subcontracted to any person or firm ineligible for award of a Government contract by virtue of section 3(a) of the Davis-Bacon Act or 29 CFR 5.12(a)(1).

c. The penalty for making false statements is prescribed in the U.S. Criminal Code, 18 U.S.C. 1001.

V. CONTRACT WORK HOURS AND SAFETY STANDARDS ACT

The following clauses apply to any Federal-aid construction contract in an amount in excess of \$100,000 and subject to the overtime provisions of the Contract Work Hours and Safety Standards Act. These clauses shall be inserted in addition to the clauses required by 29 CFR 5.5(a) or 29 CFR 4.6. As used in this paragraph, the terms laborers and mechanics include watchmen and guards.

1. Overtime requirements. No contractor or subcontractor contracting for any part of the contract work which may require or involve the employment of laborers or mechanics shall require or permit any such laborer or mechanic in any workweek in which he or she is employed on such work to work in excess of forty hours in such workweek unless such laborer or mechanic receives compensation at a rate not less than one and one-half times the basic rate of pay for all hours worked in excess of forty hours in such workweek.

2. Violation; liability for unpaid wages; liquidated damages. In the event of any violation of the clause set forth in paragraph (1.) of this section, the contractor and any subcontractor responsible therefor shall be liable for the unpaid wages. In addition, such contractor and subcontractor shall be liable to the United States (in the case of work done under contract for the District of Columbia or a territory, to such District or to such territory), for liquidated damages. Such liquidated damages shall be computed with respect to each individual laborer or mechanic, including watchmen and guards, employed in violation of the clause set forth in paragraph (1.) of this section, in the sum of \$10 for each calendar day on which such individual was required or permitted to work in excess of the standard workweek of forty hours without payment of the overtime wages required by the clause set forth in paragraph (1.) of this section.

3. Withholding for unpaid wages and liquidated damages. The FHWA or the contacting agency shall upon its own action or upon written request of an authorized representative of the Department of Labor withhold or cause to be withheld, from any moneys payable on account of work performed by the contractor or subcontractor under any such contract or any other Federal contract with the same prime contractor, or any other federally-assisted contract subject to the Contract Work Hours and Safety Standards Act, which is held by the same prime contractor, such sums as may be determined to be necessary to satisfy any liabilities of such contractor or subcontractor for unpaid wages and liquidated damages as provided in the clause set forth in paragraph (2.) of this section.

4. Subcontracts. The contractor or subcontractor shall insert in any subcontracts the clauses set forth in paragraph (1.) through (4.) of this section and also a clause requiring the subcontractors to include these clauses in any lower tier subcontracts. The prime contractor shall be responsible for compliance by any subcontractor or lower tier subcontractor with the clauses set forth in paragraphs (1.) through (4.) of this section.

VI. SUBLETTING OR ASSIGNING THE CONTRACT

This provision is applicable to all Federal-aid construction contracts on the National Highway System.

1. The contractor shall perform with its own organization contract work amounting to not less than 30 percent (or a greater percentage if specified elsewhere in the contract) of the total original contract price, excluding any specialty items designated by the contracting agency. Specialty items may be performed by subcontract and the amount of any such specialty items performed may be deducted from the total original contract price before computing the amount of work required to be performed by the contractor's own organization (23 CFR 635.116).

a. The term “perform work with its own organization” refers to workers employed or leased by the prime contractor, and equipment owned or rented by the prime contractor, with or without operators. Such term does not include employees or equipment of a subcontractor or lower tier subcontractor, agents of the prime contractor, or any other assignees. The term may include payments for the costs of hiring leased employees from an employee leasing firm meeting all relevant Federal and State regulatory requirements. Leased employees may only be included in this term if the prime contractor meets all of the following conditions:

- (1) the prime contractor maintains control over the supervision of the day-to-day activities of the leased employees;
- (2) the prime contractor remains responsible for the quality of the work of the leased employees;
- (3) the prime contractor retains all power to accept or exclude individual employees from work on the project; and
- (4) the prime contractor remains ultimately responsible for the payment of predetermined minimum wages, the submission of payrolls, statements of compliance and all other Federal regulatory requirements.

b. "Specialty Items" shall be construed to be limited to work that requires highly specialized knowledge, abilities, or equipment not ordinarily available in the type of contracting organizations qualified and expected to bid or propose on the contract as a whole and in general are to be limited to minor components of the overall contract.

2. The contract amount upon which the requirements set forth in paragraph (1) of Section VI is computed includes the cost of material and manufactured products which are to be purchased or produced by the contractor under the contract provisions.

3. The contractor shall furnish (a) a competent superintendent or supervisor who is employed by the firm, has full authority to direct performance of the work in accordance with the contract requirements, and is in charge of all construction operations (regardless of who performs the work) and (b) such other of its own organizational resources (supervision, management, and engineering services) as the contracting officer determines is necessary to assure the performance of the contract.

4. No portion of the contract shall be sublet, assigned or otherwise disposed of except with the written consent of the contracting officer, or authorized representative, and such consent when given shall not be construed to relieve the contractor of any responsibility for the fulfillment of the contract. Written consent will be given only after the contracting agency has assured that each subcontract is evidenced in writing and that it contains all pertinent provisions and requirements of the prime contract.

5. The 30% self-performance requirement of paragraph (1) is not applicable to design-build contracts; however, contracting agencies may establish their own self-performance requirements.

VII. SAFETY: ACCIDENT PREVENTION

This provision is applicable to all Federal-aid construction contracts and to all related subcontracts.

1. In the performance of this contract the contractor shall comply with all applicable Federal, State, and local laws governing safety, health, and sanitation (23 CFR 635). The contractor shall provide all safeguards, safety devices and protective equipment and take any other needed actions as it determines, or as the contracting officer may determine, to be reasonably necessary to protect the life and health of employees on the job and the safety of the public and to protect property in connection with the performance of the work covered by the contract.

2. It is a condition of this contract, and shall be made a condition of each subcontract, which the contractor enters into pursuant to this contract, that the contractor and any subcontractor shall not permit any employee, in performance of the contract, to work in surroundings or under conditions which are unsanitary, hazardous or dangerous to his/her health or safety, as determined under construction safety and health standards (29 CFR 1926) promulgated by the Secretary of Labor, in accordance with Section 107 of the Contract Work Hours and Safety Standards Act (40 U.S.C. 3704).

3. Pursuant to 29 CFR 1926.3, it is a condition of this contract that the Secretary of Labor or authorized representative thereof, shall have right of entry to any site of contract performance to inspect or investigate the matter of compliance with the construction safety and health standards and to carry out the duties of the Secretary under Section 107 of the Contract Work Hours and Safety Standards Act (40 U.S.C.3704).

VIII. FALSE STATEMENTS CONCERNING HIGHWAY PROJECTS

This provision is applicable to all Federal-aid construction contracts and to all related subcontracts.

In order to assure high quality and durable construction in conformity with approved plans and specifications and a high degree of reliability on statements and representations made by engineers, contractors, suppliers, and workers on Federal-aid highway projects, it is essential that all persons concerned with the project perform their functions as carefully, thoroughly, and honestly as possible. Willful falsification, distortion, or misrepresentation with respect to any facts related to the project is a violation of Federal law. To prevent any misunderstanding regarding the seriousness of these and similar acts, Form FHWA-1022 shall be posted on each Federal-aid highway project (23 CFR 635) in one or more places where it is readily available to all persons concerned with the project:

18 U.S.C. 1020 reads as follows:

"Whoever, being an officer, agent, or employee of the United States, or of any State or Territory, or whoever, whether a person, association, firm, or corporation, knowingly makes any false statement, false representation, or false report as to the character, quality, quantity, or cost of the material used or to be used, or the quantity or quality of the work performed or to be performed, or the cost thereof in connection with the submission of plans, maps, specifications, contracts, or costs of construction on any highway or related project submitted for approval to the Secretary of Transportation; or

Whoever knowingly makes any false statement, false representation, false report or false claim with respect to the character, quality, quantity, or cost of any work performed or to be performed, or materials furnished or to be furnished, in connection with the construction of any highway or related project approved by the Secretary of Transportation; or

Whoever knowingly makes any false statement or false representation as to material fact in any statement, certificate, or report submitted pursuant to provisions of the Federal-aid Roads Act approved July 1, 1916, (39 Stat. 355), as amended and supplemented;

Shall be fined under this title or imprisoned not more than 5 years or both."

IX. IMPLEMENTATION OF CLEAN AIR ACT AND FEDERAL WATER POLLUTION CONTROL ACT

This provision is applicable to all Federal-aid construction contracts and to all related subcontracts.

By submission of this bid/proposal or the execution of this contract, or subcontract, as appropriate, the bidder, proposer, Federal-aid construction contractor, or subcontractor, as appropriate, will be deemed to have stipulated as follows:

1. That any person who is or will be utilized in the performance of this contract is not prohibited from receiving an award due to a violation of Section 508 of the Clean Water Act or Section 306 of the Clean Air Act.
2. That the contractor agrees to include or cause to be included the requirements of paragraph (1) of this Section X in every subcontract, and further agrees to take such action as the contracting agency may direct as a means of enforcing such requirements.

X. CERTIFICATION REGARDING DEBARMENT, SUSPENSION, INELIGIBILITY AND VOLUNTARY EXCLUSION

This provision is applicable to all Federal-aid construction contracts, design-build contracts, subcontracts, lower-tier subcontracts, purchase orders, lease agreements, consultant contracts or any other covered transaction requiring FHWA approval or that is estimated to cost \$25,000 or more – as defined in 2 CFR Parts 180 and 1200.

1. Instructions for Certification – First Tier Participants:

- a. By signing and submitting this proposal, the prospective first tier participant is providing the certification set out below.
- b. The inability of a person to provide the certification set out below will not necessarily result in denial of participation in this covered transaction. The prospective first tier participant shall submit an explanation of why it cannot provide the certification set out below. The certification or explanation will be considered in connection with the department or agency's determination whether to enter into this transaction. However, failure of the prospective first tier participant to furnish a certification or an explanation shall disqualify such a person from participation in this transaction.
- c. The certification in this clause is a material representation of fact upon which reliance was placed when the contracting agency determined to enter into this transaction. If it is later determined that the prospective participant knowingly rendered an erroneous certification, in addition to other remedies available to the Federal Government, the contracting agency may terminate this transaction for cause of default.

d. The prospective first tier participant shall provide immediate written notice to the contracting agency to whom this proposal is submitted if any time the prospective first tier participant learns that its certification was erroneous when submitted or has become erroneous by reason of changed circumstances.

e. The terms "covered transaction," "debarred," "suspended," "ineligible," "participant," "person," "principal," and "voluntarily excluded," as used in this clause, are defined in 2 CFR Parts 180 and 1200. "First Tier Covered Transactions" refers to any covered transaction between a grantee or subgrantee of Federal funds and a participant (such as the prime or general contract). "Lower Tier Covered Transactions" refers to any covered transaction under a First Tier Covered Transaction (such as subcontracts). "First Tier Participant" refers to the participant who has entered into a covered transaction with a grantee or subgrantee of Federal funds (such as the prime or general contractor). "Lower Tier Participant" refers any participant who has entered into a covered transaction with a First Tier Participant or other Lower Tier Participants (such as subcontractors and suppliers).

f. The prospective first tier participant agrees by submitting this proposal that, should the proposed covered transaction be entered into, it shall not knowingly enter into any lower tier covered transaction with a person who is debarred, suspended, declared ineligible, or voluntarily excluded from participation in this covered transaction, unless authorized by the department or agency entering into this transaction.

g. The prospective first tier participant further agrees by submitting this proposal that it will include the clause titled "Certification Regarding Debarment, Suspension, Ineligibility and Voluntary Exclusion-Lower Tier Covered Transactions," provided by the department or contracting agency, entering into this covered transaction, without modification, in all lower tier covered transactions and in all solicitations for lower tier covered transactions exceeding the \$25,000 threshold.

h. A participant in a covered transaction may rely upon a certification of a prospective participant in a lower tier covered transaction that is not debarred, suspended, ineligible, or voluntarily excluded from the covered transaction, unless it knows that the certification is erroneous. A participant is responsible for ensuring that its principals are not suspended, debarred, or otherwise ineligible to participate in covered transactions. To verify the eligibility of its principals, as well as the eligibility of any lower tier prospective participants, each participant may, but is not required to, check the Excluded Parties List System website (<https://www.epls.gov/>), which is compiled by the General Services Administration.

i. Nothing contained in the foregoing shall be construed to require the establishment of a system of records in order to render in good faith the certification required by this clause. The knowledge and information of the prospective participant is not required to exceed that which is normally possessed by a prudent person in the ordinary course of business dealings.

j. Except for transactions authorized under paragraph (f) of these instructions, if a participant in a covered transaction knowingly enters into a lower tier covered transaction with a person who is suspended, debarred, ineligible, or voluntarily excluded from participation in this transaction, in addition to other remedies available to the Federal Government, the department or agency may terminate this transaction for cause or default.

* * * * *

2. Certification Regarding Debarment, Suspension, Ineligibility and Voluntary Exclusion – First Tier Participants:

a. The prospective first tier participant certifies to the best of its knowledge and belief, that it and its principals:

(1) Are not presently debarred, suspended, proposed for debarment, declared ineligible, or voluntarily excluded from participating in covered transactions by any Federal department or agency;

(2) Have not within a three-year period preceding this proposal been convicted of or had a civil judgment rendered against them for commission of fraud or a criminal offense in connection with obtaining, attempting to obtain, or performing a public (Federal, State or local) transaction or contract under a public transaction; violation of Federal or State antitrust statutes or commission of embezzlement, theft, forgery, bribery, falsification or destruction of records, making false statements, or receiving stolen property;

(3) Are not presently indicted for or otherwise criminally or civilly charged by a governmental entity (Federal, State or local) with commission of any of the offenses enumerated in paragraph (a)(2) of this certification; and

(4) Have not within a three-year period preceding this application/proposal had one or more public transactions (Federal, State or local) terminated for cause or default.

b. Where the prospective participant is unable to certify to any of the statements in this certification, such prospective participant shall attach an explanation to this proposal.

2. Instructions for Certification - Lower Tier Participants:

(Applicable to all subcontracts, purchase orders and other lower tier transactions requiring prior FHWA approval or estimated to cost \$25,000 or more - 2 CFR Parts 180 and 1200)

a. By signing and submitting this proposal, the prospective lower tier is providing the certification set out below.

b. The certification in this clause is a material representation of fact upon which reliance was placed when this transaction was entered into. If it is later determined that the prospective lower tier participant knowingly rendered an erroneous certification, in addition to other remedies available to the Federal Government, the department, or agency with which this transaction originated may pursue available remedies, including suspension and/or debarment.

c. The prospective lower tier participant shall provide immediate written notice to the person to which this proposal is submitted if at any time the prospective lower tier participant learns that its certification was erroneous by reason of changed circumstances.

d. The terms "covered transaction," "debarred," "suspended," "ineligible," "participant," "person," "principal," and "voluntarily excluded," as used in this clause, are defined in 2 CFR Parts 180 and 1200. You may contact the person to which this proposal is submitted for assistance in obtaining a copy of those regulations. "First Tier Covered Transactions" refers to any covered transaction between a grantee or subgrantee of Federal funds and a participant (such as the prime or general contract). "Lower Tier Covered Transactions" refers to any covered transaction under a First Tier Covered Transaction (such as subcontracts). "First Tier Participant" refers to the participant who has entered into a covered transaction with a grantee or subgrantee of Federal funds (such as the prime or general contractor). "Lower Tier Participant" refers any participant who has entered into a covered transaction with a First Tier Participant or other Lower Tier Participants (such as subcontractors and suppliers).

e. The prospective lower tier participant agrees by submitting this proposal that, should the proposed covered transaction be entered into, it shall not knowingly enter into any lower tier covered transaction with a person who is debarred, suspended, declared ineligible, or voluntarily excluded from participation in this covered transaction, unless authorized by the department or agency with which this transaction originated.

f. The prospective lower tier participant further agrees by submitting this proposal that it will include this clause titled "Certification Regarding Debarment, Suspension, Ineligibility and Voluntary Exclusion-Lower Tier Covered Transaction," without modification, in all lower tier covered transactions and in all solicitations for lower tier covered transactions exceeding the \$25,000 threshold.

g. A participant in a covered transaction may rely upon a certification of a prospective participant in a lower tier covered transaction that is not debarred, suspended, ineligible, or voluntarily excluded from the covered transaction, unless it knows that the certification is erroneous. A participant is responsible for ensuring that its principals are not suspended, debarred, or otherwise ineligible to participate in covered transactions. To verify the eligibility of its principals, as well as the eligibility of any lower tier prospective participants, each participant may, but is not required to, check the Excluded Parties List System website (<https://www.epls.gov/>), which is compiled by the General Services Administration.

h. Nothing contained in the foregoing shall be construed to require establishment of a system of records in order to render in good faith the certification required by this clause. The knowledge and information of participant is not required to exceed that which is normally possessed by a prudent person in the ordinary course of business dealings.

i. Except for transactions authorized under paragraph e of these instructions, if a participant in a covered transaction knowingly enters into a lower tier covered transaction with a person who is suspended, debarred, ineligible, or voluntarily excluded from participation in this transaction, in addition to other remedies available to the Federal Government, the department or agency with which this transaction originated may pursue available remedies, including suspension and/or debarment.

* * * * *

**Certification Regarding Debarment, Suspension, Ineligibility and Voluntary Exclusion--
Lower Tier Participants:**

1. The prospective lower tier participant certifies, by submission of this proposal, that neither it nor its principals is presently debarred, suspended, proposed for debarment, declared ineligible, or voluntarily excluded from participating in covered transactions by any Federal department or agency.

2. Where the prospective lower tier participant is unable to certify to any of the statements in this certification, such prospective participant shall attach an explanation to this proposal.

XI. CERTIFICATION REGARDING USE OF CONTRACT FUNDS FOR LOBBYING

This provision is applicable to all Federal-aid construction contracts and to all related subcontracts which exceed \$100,000 (49 CFR 20).

1. The prospective participant certifies, by signing and submitting this bid or proposal, to the best of his or her knowledge and belief, that:

a. No Federal appropriated funds have been paid or will be paid, by or on behalf of the undersigned, to any person for influencing or attempting to influence an officer or employee of any Federal agency, a Member of Congress, an officer or employee of Congress, or an employee of a Member of Congress in connection with the awarding of any Federal contract, the making of any Federal grant, the making of any Federal loan, the entering into of any cooperative agreement, and the extension, continuation, renewal, amendment, or modification of any Federal contract, grant, loan, or cooperative agreement.

b. If any funds other than Federal appropriated funds have been paid or will be paid to any person for influencing or attempting to influence an officer or employee of any Federal agency, a Member of Congress, an officer or employee of Congress, or an employee of a Member of Congress in connection with this Federal contract, grant, loan, or cooperative agreement, the undersigned shall complete and submit Standard Form-LLL, "Disclosure Form to Report Lobbying," in accordance with its instructions.

2. This certification is a material representation of fact upon which reliance was placed when this transaction was made or entered into. Submission of this certification is a prerequisite for making or entering into this transaction imposed by 31 U.S.C. 1352. Any person who fails to file the required certification shall be subject to a civil penalty of not less than \$10,000 and not more than \$100,000 for each such failure.

3. The prospective participant also agrees by submitting its bid or proposal that the participant shall require that the language of this certification be included in all lower tier subcontracts, which exceed \$100,000 and that all such recipients shall certify and disclose accordingly.

**ATTACHMENT A - EMPLOYMENT AND MATERIALS PREFERENCE FOR
APPALACHIAN DEVELOPMENT HIGHWAY SYSTEM OR APPALACHIAN LOCAL
ACCESS ROAD CONTRACTS**

This provision is applicable to all Federal-aid projects funded under the Appalachian Regional Development Act of 1965.

1. During the performance of this contract, the contractor undertaking to do work which is, or reasonably may be, done as on-site work, shall give preference to qualified persons who regularly reside in the labor area as designated by the DOL wherein the contract work is situated, or the subregion, or the Appalachian counties of the State wherein the contract work is situated, except:

a. To the extent that qualified persons regularly residing in the area are not available.

b. For the reasonable needs of the contractor to employ supervisory or specially experienced personnel necessary to assure an efficient execution of the contract work.

c. For the obligation of the contractor to offer employment to present or former employees as the result of a lawful collective bargaining contract, provided that the number of nonresident persons employed under this subparagraph (1c) shall not exceed 20 percent of the total number of employees employed by the contractor on the contract work, except as provided in subparagraph (4) below.

2. The contractor shall place a job order with the State Employment Service indicating (a) the classifications of the laborers, mechanics and other employees required to perform the contract work, (b) the number of employees required in each classification, (c) the date on which the participant estimates such employees will be required, and (d) any other pertinent information required by the State Employment Service to complete the job order form. The job order may be placed with the State Employment Service in writing or by telephone. If during the course of the contract work, the information submitted by the contractor in the original job order is substantially modified, the participant shall promptly notify the State Employment Service.

3. The contractor shall give full consideration to all qualified job applicants referred to him by the State Employment Service. The contractor is not required to grant employment to any job applicants who, in his opinion, are not qualified to perform the classification of work required.

4. If, within one week following the placing of a job order by the contractor with the State Employment Service, the State Employment Service is unable to refer any qualified job applicants to the contractor, or less than the number requested, the State Employment Service will forward a certificate to the contractor indicating the unavailability of applicants. Such certificate shall be made a part of the contractor's permanent project records. Upon receipt of this certificate, the contractor may employ persons who do not normally reside in the labor area to fill positions covered by the certificate, notwithstanding the provisions of subparagraph (1c) above.

5. The provisions of 23 CFR 633.207(e) allow the contracting agency to provide a contractual preference for the use of mineral resource materials native to the Appalachian region.

6. The contractor shall include the provisions of Sections 1 through 4 of this Attachment A in every subcontract for work which is, or reasonably may be, done as on-site work.

End of FHWA 1273

The United States Department of Transportation (USDOT)

FHWA STANDARD TITLE VI/NONDISCRIMINATION ASSURANCES

DOT Order No. 1050.2A

The Maine Department of Transportation (herein referred to as the "Recipient"), **HEREBY AGREES THAT**, as a condition to receiving any Federal financial assistance from the U.S. Department of Transportation (DOT), through The Federal Highway Administration (FHWA), is subject to and will comply with the following:

Statutory/Regulatory Authorities

- Title VI of the Civil Rights Act of 1964 (42 U.S.C. § 2000d *et seq.*, 78 stat. 252), (prohibits discrimination on the basis of race, color, national origin);
- 49 C.F.R. Part 21 (entitled *Nondiscrimination In Federally-Assisted Programs Of The Department Of Transportation—Effectuation Of Title VI Of The Civil Rights Act Of 1964*);
- 28 C.F.R. section 50.3 (U.S. Department of Justice Guidelines for Enforcement of Title VI of the Civil Rights Act of 1964);

FHWA may include additional Statutory/Regulatory Authorities here.

The preceding statutory and regulatory cites hereinafter are referred to as the "Acts" and "Regulations," respectively.

General Assurances

In accordance with the Acts, the Regulations, and other pertinent directives, circulars, policy, memoranda, and/or guidance, the Recipient hereby gives assurance that it will promptly take any measures necessary to ensure that:

No person in the United States shall, on the grounds of race, color, or national origin, be excluded from participation in, be denied the benefits of, or be otherwise subjected to discrimination under any program or activity," for which the Recipient receives Federal financial assistance from DOT, including FHWA..

The Civil Rights Restoration Act of 1987 clarified the original intent of Congress, with respect to Title VI and other Nondiscrimination requirements (The Age Discrimination Act of 1975, and Section 504 of the Rehabilitation Act of 1973), by restoring the broad, institutional-wide scope and coverage of these nondiscrimination statutes and requirements to include all programs and activities of the Recipient, so long as any portion of the program is Federally assisted.

FHWA may include additional General Assurances in this section, or reference an addendum here.

Specific Assurances

More specifically, and without limiting the above general Assurance, the Recipient agrees with and gives the following Assurances with respect to its federally assisted programs:

1. The Recipient agrees that each "activity," "facility," or "program," as defined in §§ 21.23 (b) and 21.23 (e) of 49 C.F.R. § 21 will be (with regard to an "activity") facilitated, or will be (with regard to a "facility") operated, or will be (with regard to a "program") conducted in compliance with all requirements imposed by, or pursuant to the Acts and the Regulations.
2. The Recipient will insert the following notification in all solicitations for bids, Requests For Proposals for work, or material subject to the Acts and the Regulations made in connection with all Federal Highway Programs and, in adapted form, in all proposals for negotiated agreements regardless of funding source:

The (Agency), in accordance with the provisions of Title VI of the Civil Rights Act of 1964 (78 Stat. 252, 42 U.S.C. §§ 2000d to 2000d-4) and the Regulations, hereby notifies all bidders that it will affirmatively insure that any contract entered into pursuant to this advertisement, disadvantaged business enterprises will be afforded full opportunity to submit bids in response to this invitation and will not be discriminated against on the grounds of race, color, or national origin in consideration for an award.

3. The Recipient will insert the clauses of Appendix A and E of this Assurance in every contract or agreement subject to the Acts and the Regulations.
4. The Recipient will insert the clauses of Appendix B of this Assurance, as a covenant running with the land, in any deed from the United States effecting or recording a transfer of real property, structures, use, or improvements thereon or interest therein to a Recipient.
5. That where the Recipient receives Federal financial assistance to construct a facility, or part of a facility, the Assurance will extend to the entire facility and facilities operated in connection therewith.
6. That where the Recipient receives Federal financial assistance in the form, or for the acquisition of real property or an interest in real property, the Assurance will extend to rights to space on, over, or under such property.
7. That the Recipient will include the clauses set forth in Appendix C and Appendix D of this Assurance, as a covenant running with the land, in any future deeds, leases, licenses, permits, or similar instruments entered into by the Recipient with other parties:
 - a. for the subsequent transfer of real property acquired or improved under the applicable activity, project, or program; and
 - b. for the construction or use of, or access to, space on, over, or under real property acquired or improved under the applicable activity, project, or program.
8. That this Assurance obligates the Recipient for the period during which Federal financial assistance is extended to the program, except where the Federal financial assistance is to provide, or is in the form of, personal property, or real property, or interest therein, or structures or improvements thereon, in which case the Assurance obligates the Recipient, or any transferee for the longer of the following periods:

- a. the period during which the property is used for a purpose for which the Federal financial assistance is extended, or for another purpose involving the provision of similar services or benefits; or
 - b. the period during which the Recipient retains ownership or possession of the property.
9. The Recipient will provide for such methods of administration for the program as are found by the Secretary of Transportation or the official to whom he/she delegates specific authority to give reasonable guarantee that it, other recipients, sub-recipients, sub-grantees, contractors, subcontractors, consultants, transferees, successors in interest, and other participants of Federal financial assistance under such program will comply with all requirements imposed or pursuant to the Acts, the Regulations, and this Assurance.
10. The Recipient agrees that the United States has a right to seek judicial enforcement with regard to any matter arising under the Acts, the Regulations, and this Assurance.

FHWA may include additional Specific Assurances in this section.

By signing this ASSURANCE, Maine Department of Transportation also agrees to comply (and require any subrecipients, sub-grantees, contractors, successors, transferees, and/or assignees to comply) with all applicable provisions governing the FHWA access to records, accounts, documents, information, facilities, and staff. You also recognize that you must comply with any program or compliance reviews, and/or complaint investigations conducted by FHWA. You must keep records, reports, and submit the material for review upon request to FHWA, or their designees in a timely, complete, and accurate way. Additionally, you must comply with all other reporting, data collection, and evaluation requirements, as prescribed by law or detailed in program guidance.

Maine Department of Transportation gives this ASSURANCE in consideration of and for obtaining any Federal grants, loans, contracts, agreements, property, and/or discounts, or other Federal-aid and Federal financial assistance extended after the date hereof to the recipients by the U.S. Department of Transportation. This ASSURANCE is binding on Maine Department of Transportation, other recipients, sub-recipients, sub-grantees, contractors, subcontractors and their subcontractors', transferees, successors in interest, and any other participants in it programs. . The person(s) signing below is authorized to sign this ASSURANCE on behalf of the Recipient.

Name of Recipient: Maine Department of Transportation



David Bernhardt, Commissioner

DATED: 9/18/14

APPENDIX A

During the performance of this contract, the contractor, for itself, its assignees, and successors in interest (hereinafter referred to as the “contractor”) agrees as follows:

1. **Compliance with Regulations:** The contractor (hereinafter includes consultants) will comply with the Acts and the Regulations relative to Nondiscrimination in Federally-assisted programs of the U.S. Department of Transportation, **Federal Highway Administration**, as they may be amended from time to time, which are herein incorporated by reference and made a part of this contract.
2. **Nondiscrimination:** The contractor, with regard to the work performed by it during the contract, will not discriminate on the grounds of race, color, or national origin in the selection and retention of subcontractors, including procurements of materials and leases of equipment. The contractor will not participate directly or indirectly in the discrimination prohibited by the Acts and the Regulations as set forth in Appendix E, including employment practices when the contract covers any activity, project, or program set forth in Appendix B of 49 CFR Part 21.
3. **Solicitations for Subcontracts, Including Procurements of Materials and Equipment:** In all solicitations, either by competitive bidding, or negotiation made by the contractor for work to be performed under a subcontract, including procurements of materials, or leases of equipment, each potential subcontractor or supplier will be notified by the contractor of the contractor’s obligations under this contract and the Acts and the Regulations relative to Non-discrimination on the grounds of race, color, or national origin.
4. **Information and Reports:** The contractor will provide all information and reports required by the Acts, the Regulations and directives issued pursuant thereto and will permit access to its books, records, accounts, other sources of information, and its facilities as may be determined by the Recipient or the **Federal Highway Administration**, to be pertinent to ascertain compliance with such Acts, Regulations, and instructions. Where any information required of a contractor is in the exclusive possession of another who fails or refuses to furnish the information, the contractor will so certify to the Recipient or the **Federal Highway Administration**, as appropriate, and will set forth what efforts it has made to obtain the information.
5. **Sanctions for Noncompliance:** In the event of a contractor’s noncompliance with the Non-discrimination provisions of this contract, the Recipient will impose such contract sanctions as it or the **Federal Highway Administration**, may determine to be appropriate, including, but not limited to:
 - a. withholding payments to the contractor under the contract until the contractor complies; and/or
 - b. cancelling, terminating, or suspending a contract, in whole or in part.

Incorporation of Provisions: The contractor will include the provisions of paragraphs one through six in every subcontract, including procurements of materials and leases of equipment, unless exempt by the Acts, the Regulations and directives issued pursuant thereto. The contractor will take action with respect to any subcontract or procurement as the Recipient or the **Federal Highway Administration**, may direct as a means of enforcing such provisions including sanctions for noncompliance. Provided, that if the contractor becomes involved in, or is threatened with litigation by a subcontractor, or supplier because of such direction, the contractor may request the Recipient to enter into any litigation to protect the interests of the Recipient. In addition, the contractor may request the United States to enter into the litigation to protect the interests of the United States.

(APPENDIX C TO MAINEDOT TITLE VI ASSURANCE)

FEDERAL HIGHWAY ADMINISTRATION ASSISTED PROGRAMS

The following clauses shall be included in all deeds, licenses, leases, permits, or similar instruments entered into

by the Maine Department of Transportation pursuant to the provisions of Assurance 7(a).

The (grantee, licensee, lessee, permittee, etc., as appropriate) for herself/himself, his/her heirs, personal representatives, successors in interest, and assigns, as a part of the consideration hereof, does hereby covenant and agree [in the case of deeds and leases add "as a covenant running with the land"] that in the event facilities are constructed, maintained, or otherwise operated on the said property described in this (deed, license, lease, permit, etc.) for a purpose for which a Department of Transportation program or activity is extended or for another purpose involving the provision of similar services or benefits, the (grantee, licensee lessee, permittee, etc.) shall maintain and operate such facilities and services in compliance with all other requirements imposed pursuant to Title 49, Code of Federal Regulations, Department of Transportation, Subtitle A, Office of the Secretary, Part 21, Nondiscrimination of Federally-Assisted Programs of the Department of Transportation - Effectuation of Title VI of the Civil Rights Act of 1964, and as said Regulations may be amended.

[Include in licenses, leases, permits, etc.]*

That in the event of breach of any of the above nondiscrimination covenants, Maine Department of Transportation shall have the right to terminate the [license, lease, permit, etc.] and to re-enter and repossess said land and the facilities thereon, and hold the same as if said [licenses, lease, permit, etc.] had never been made or issued.

[Include in deeds]*

That in the event of breach of any of the above nondiscrimination covenants, Maine Department of Transportation shall have the right to re-enter said lands and facilities thereon, and the above described lands and facilities shall thereupon revert to and vest in and become the absolute property of Maine Department of Transportation and its assigns.

The following shall be included in all deeds, licenses, leases, permits, or similar agreements entered into by Maine Department of Transportation pursuant to the provisions of Assurance 7(b).

The (grantee, licensee, lessee, permittee, etc., as appropriate) for herself/himself, his/her personal representatives, successors in interest, and assigns, as a part of the consideration hereof, does hereby covenant and agree (in case of deeds, and leases add "as a covenant running with the land") that (1) no person on the grounds of race, color, or national origin shall be excluded from participation in, be denied the benefits of, or be otherwise subjected to discrimination in the use of said facilities, (2) that in the construction of any improvements on, over or under such land and the furnishing services thereon, no person on the grounds of race, color, or national origin shall be excluded from the participation in, be denied the benefits of, or be otherwise subjected to discrimination, and (3) that the (grantee, licensee, lessee, permittee, etc.) shall use the premises in compliance with all other requirements imposed by or pursuant to Title 49, Code of Federal Regulations, Department of Transportation, Subtitle A, Office of the Secretary, Part 21, Nondiscrimination in Federally-Assisted Programs of the Department of Transportation - Effectuation of Title VI of the Civil Rights Act of 1964, and as said Regulations may be amended.

[Include in licenses, leases, permits, etc.]*

That in the event of breach of any of the above nondiscrimination covenants, Maine Department of Transportation shall have the right to terminate the [license, lease, permit, etc.] and to re-enter and repossess said land and the facilities thereon, and hold the same as if said [license, lease, permit, etc.] had never been made or issued.

[Include in deeds]*

That in the event of breach of any of the above nondiscrimination covenants, Maine Department of Transportation shall have the right to re-enter said land and facilities thereon, and the above described lands and facilities shall thereupon revert to and vest in and become the absolute property of Maine Department of Transportation and its assigns.

* Reverter clause and related language to be used only when it is determined that such a clause is necessary in order to effectuate the purpose of Title VI of the Civil Rights Act of 1964.

APPENDIX D

CLAUSES FOR CONSTRUCTION/USE/ACCESS TO REAL PROPERTY ACQUIRED UNDER THE ACTIVITY, FACILITY OR PROGRAM

The following clauses will be included in deeds, licenses, permits, or similar instruments/agreements entered into by The Maine Department of Transportation pursuant to the provisions of Assurance 7(b):

- A. The (grantee, licensee, permittee, etc., as appropriate) for himself/herself, his/her heirs, personal representatives, successors in interest, and assigns, as a part of the consideration hereof, does hereby covenant and agree (in the case of deeds and leases add, “as a covenant running with the land”) that (1) no person on the ground of race, color, or national origin, will be excluded from participation in, denied the benefits of, or be otherwise subjected to discrimination in the use of said facilities, (2) that in the construction of any improvements on, over, or under such land, and the furnishing of services thereon, no person on the ground of race, color, or national origin, will be excluded from participation in, denied the benefits of, or otherwise be subjected to discriminations, (3) that the (grantee, licensees, lessee, permittee, etc.) will use the premises in compliance with all other requirements imposed by or pursuant to the Acts and Regulations, as amended, set forth in this Assurance.
- B. With respect to (licenses, leases, permits, etc.), in the event of breach of any of the above Non-discrimination covenants, (**The Maine Department of Transportation**) will have the right to terminate the (license, permit, etc., as appropriate) and to enter or re-enter and repossess said land and the facilities thereon, and hold the same as if said (license, permit, etc., as appropriate) had never been made or issued.*
- C. With respect to deeds, in the event of breach of any of the above Non-discrimination covenants, (**The Maine Department of Transportation**) will there upon revert to and vest in and become the absolute property of (**The Maine Department of Transportation**) and its assigns.*

(*Reverter clause and related language to be used only when it is determined that such a clause is necessary to make clear the purpose of Title VI.)

APPENDIX E

During the performance of this contract, the contractor, for itself, its assignees, and successors in interest (hereinafter referred to as the “contractor”) agrees to comply with the following non-discrimination statutes and authorities; including but not limited to:

Pertinent Non-Discrimination Authorities:

- Title VI of the Civil Rights Act of 1964 (42 U.S.C. §2000d *et seq.*, 78 stat. 252), (prohibits discrimination on the basis of race, color, national origin); and 49 CFR Part 21.
- The Uniform Relocation Assistance and Real Property Acquisition Policies Act of 1970, (42 U.S.C. §4601), (prohibits unfair treatment of persons displaced or whose property has been acquired because of Federal or Federal-aid programs and projects);
- Federal-Aid Highway Act of 1973, (23 U.S.C. §324 *et seq.*), (prohibits discrimination on the basis of sex);
- Section 504 of the Rehabilitation Act of 1973, (29 U.S.C. §794 *et seq.*), as amended, (prohibits discrimination on the basis of disability); and 49 CFR Part 27;
- The Age Discrimination Act of 1975, as amended, (42 U.S.C. §6101 *et seq.*), (prohibits discrimination on the basis of age);
- Airport and Airway Improvement Act of 1982, (49 U.S.C. §471, Section 47123), as amended, (prohibits discrimination based on race, creed, color, national origin, or sex);
- The Civil Rights Restoration Act of 1987, (PL 100-209), (Broadened the scope, coverage and applicability of Title VI of the Civil Rights Act of 1964, The Age Discrimination Act of 1975 and Section 504 of the Rehabilitation Act of 1973, by expanding the definition of the terms “programs or activities” to include all of the programs or activities of the Federal-aid recipients, sub-recipients and contractors, whether such programs or activities are Federally funded or not);
- Titles II and III of the Americans with Disabilities Act, which prohibit discrimination on the basis of disability in the operation of public entities, public and private transportation systems, places of public accommodation, and certain testing entities (42 U.S.C. §§12131-12189) as implemented by Department of Transportation regulations at 49 C.F.R. Parts 37 and 38;
- The Federal Aviation Administration’s Non-discrimination statute (49 U.S.C. §47123) (prohibits discrimination on the basis of race, color, national origin and sex);
- Executive Order 12898, Federal Actions to Address Environmental Justice in Minority Populations and Low-Income Populations, which ensures discrimination against minority populations by discouraging programs, policies, and activities with disproportionately high and adverse human health or environmental effects on minority and low-income populations;
- Executive Order 13166, Improving Access to Services for Persons with Limited English Proficiency, and resulting agency guidance, national origin discrimination includes discrimination because of limited English proficiency (LEP). To ensure compliance with Title VI, you must take reasonable steps to ensure that LEP persons have meaningful access to your programs (70 Fed. Reg. at 74087 to 74100);
- Title IX of the Education Amendments of 1972, as amended, which prohibits you from discriminating of sex in education programs or activities (20 U.S.C. 1681 *et seq.*).



Environmental Summary Sheet

WIN: 23302.00
Town: Littleton-Monitcello
CPD Team Leader: Colin Greenan
ENV Field Contact: Jamey Reitmeyer

Date Submitted: 2/5/18

NEPA Complete: Programmatic Categorical Exclusion per 23 CFR §771.117(c)(26) on February 5, 2018

Section 106
Complete- PA-B
Section 106 Resources:

Section 4(f) and 6(f)
Section 4(f)
Complete- no use
Section 6(f)
Complete- no takes

Maine Department of Inland Fisheries and Wildlife Essential Habitat
Not Applicable **Timing Window:** Not Applicable

Section 7
No effect- no tree clearing proposed
Species of Concern: Canada lynx and Northern long-eared bat

Essential Fish Habitat
Not Applicable- project is not located within a mapped EFH

Maine Department of Conservation/Public Lands, Submerged Land Lease
Not Applicable

Maine Land Use Regulation Commission
Not Applicable

Maine Department of Environmental Protection
Not applicable- no in stream work proposed
**Applicable Standards and Permits are included with the contract*

Army Corps of Engineers: Section 10 of the Rivers and Harbors Act and Section 404 of the Clean Water Act.
Not Applicable- no in stream work proposed
**Applicable Standards and Permits are included with the contract*

Stormwater Review
Not Applicable

<input checked="" type="checkbox"/> Special Provisions Required		
Special Provision 105-Timing of Work Restriction	N/A <input checked="" type="checkbox"/>	Applicable <input type="checkbox"/>
Special Provision 656-Minor Soil Disturbance	N/A <input checked="" type="checkbox"/>	Applicable <input type="checkbox"/>
Standard Specification 656-Erosion Control Plan	N/A <input type="checkbox"/>	Applicable <input checked="" type="checkbox"/>
Special Provision 203-Dredge Spec	N/A <input checked="" type="checkbox"/>	Applicable <input type="checkbox"/>
General Note for Hazardous Waste	N/A <input checked="" type="checkbox"/>	Applicable <input type="checkbox"/>
Special Provision 203-Special Fill-Streambed Materials	N/A <input checked="" type="checkbox"/>	Applicable <input type="checkbox"/>
Special Provision 610-Stream Channel Rock	N/A <input checked="" type="checkbox"/>	Applicable <input type="checkbox"/>
Special Provision 203-Hazardous Waste	N/A <input checked="" type="checkbox"/>	Applicable <input type="checkbox"/>
Special Provision 105.9	N/A <input checked="" type="checkbox"/>	Applicable <input type="checkbox"/>

**All permits and approvals based on plans/scope as of: 12/21/17*