

Attachment H
Revised Merrill Road Converter Station Stormwater Management Plan

STORMWATER MANAGEMENT SYSTEM

Prepared for the

**CENTRAL MAINE POWER COMPANY
MERRILL ROAD CONVERTER SUBSTATION**



Location

**Merrill Road
Lewiston, ME 04240**

Owner

**Central Maine Power Company
83 Edison Drive
Augusta, Maine 04336**



Prepared by



**11733 Chesterdale Road
Cincinnati, OH 45246
(513) 326-1500
September 2017
REVISED August 2018**

TABLE OF CONTENTS

INTRODUCTION	3
MERRILL ROAD CONVERTER SUBSTATION	3
PERMITTING REQUIREMENTS	3
BASIC STANDARDS	4
EROSION AND SEDIMENTATION CONTROL	4
INSPECTION AND MAINTENANCE	4
Scheduled Inspections	4
As-Needed Maintenance	5
5-Year Re-Certification	5
HOUSEKEEPING PLAN	5
GENERAL STANDARDS	6
STORMWATER TREATMENT BMPS	6
Crushed Stone Substation Surface	6
Grassed Underdrain Soil Filter	7
Gravel Wetlands	7
Permeable Road Base	7
STORMWATER TREATMENT CALCULATIONS	8
FLOODING STANDARD	8
CONCLUSION	9
APPENDIX A – BMP INSPECTION & MAINTENANCE CHECKLISTS AND LOGS
APPENDIX B – LETTER FROM MEDEP TO CMP
APPENDIX C – STORMWATER CALCULATIONS

INTRODUCTION

Central Maine Power Company (CMP) is proposing to construct a new electrical substation as part of the New England Clean Energy Connect (NECEC) Project. The new station will be built on Merrill Road in the town of Lewiston in Androscoggin County, Maine and will be named the Merrill Road Converter Substation.

The proposed electrical substation is located within the Lower Androscoggin Watershed. Site runoff flows north to Stetson Brook, and then heads south into the Androscoggin River. The river then flows downstream to Merrymeeting Bay, then southeast to the Kennebec River and discharges into the Atlantic Ocean.

Merrill Road Converter Substation

The existing conditions and proposed grading plans for the proposed Merrill Road Converter Substation are included with this submission as sheets 1076-003-001 SH 001 General Site Plan Existing Conditions and 1076-003-001 SH 002 General Site Plan Proposed Conditions, respectively. The layout of proposed equipment within the yard is shown on SK-MER-GL Conceptual General Location Plan.

The proposed substation will sit on a 54.2 acre parcel of mostly wooded land that is a mix of somewhat steep terrain and low lying wetlands and includes an existing electric transmission line corridor. The western portion of the site is relatively flat with steeply ascending sloped terrain heading from west to east along the site. The existing transmission line corridor will be the site for a proposed access road to the station. The proposed station pad footprint will be approximately 7.10 acres and will consist of roof top, concrete foundations and pavement impervious and evenly graded 3/4" to 1.5" stone for the remainder of the station pad. The access road will consist of gravel. The station pad site will consist of a total developed area of 10.71 acres, of which, 7.15 acres will be impervious. The access road will include an additional total developed area of 2.71 acres, of which, 0.96 acres will be impervious. The site will be sloped to drain to the north, honoring the existing drainage patterns to the extent practicable. Site and road stormwater runoff will be treated with grassed underdrain soil filters, gravel wetlands and stormwater detention, while the stoned yard areas are considered to be treated in place.

Permitting Requirements

The Merrill Road Converter Substation is part of the larger NECEC Project currently being undertaken by CMP. The project is submitted as a whole to the Maine Department of Environmental Protection (MeDEP) for permitting purposes.

The project will require a Stormwater Management Permit and a Site Location of Development Permit because more than 3 acres will be stripped or graded and not revegetated within one year, and because the project will occupy more than 20 acres of land. The project will also be required to meet the Basic, General and Flooding Standards as described in MeDEP Chapter 500. The standards will be met using several erosion and sedimentation control and permanent stormwater management Best Management Practices (BMPs).

BASIC STANDARDS

The proposed project will disturb more than one acre of land, requiring compliance with the Basic Standards as described in MeDEP Chapter 500 Section 4B. In order to meet the Basic Standards, the proposed project will be required to address the following:

- Erosion and Sedimentation Control
- Inspection and Maintenance
- Housekeeping

Erosion and Sedimentation Control

Exhibit 14-1 of the Site Law application contains the manual “Central Maine Power Company Environmental Guidelines for Construction and Maintenance Activities on Transmission Line and Substation Projects”. This manual addresses general erosion and sedimentation control measures used in many previous transmission and substation projects and has been reviewed and approved by MeDEP. The manual was developed to be consistent with the Maine Erosion and Sediment Control Practices Field Guide for Contractors, 2015, and MeDEP’s Chapter 500.

Specific erosion and sedimentation control BMPs for the Merrill Road Converter Substation project are indicated on sheet 1076-003-003 SH 001 & SH 002 Erosion and Sediment Control Plan 1 and 2. Details of the measures proposed are shown on sheet 1076-003-005 SH 004 Site Details 4 and sheet 1076-003-005 SH 005 Site Details 5. Sheet 1076-003-005 SH 006 Site Details 6 presents a plan for implementing these measures at the site.

Inspection and Maintenance

CMP will ensure that a qualified design engineer inspects the construction site periodically to verify that the stormwater BMPs are constructed in accordance with the plans and specifications shown on the design drawings, and, as needed, during any period when construction activity affecting the stormwater management system occurs, until the site is permanently stabilized.

Inspection and Maintenance procedures for the proposed substation are described below. BMP Inspection & Maintenance Checklists and BMP Inspection & Maintenance Logs for each site have been enclosed in Appendix A. The BMP Inspection & Maintenance Checklists outline the required inspection frequency/requirements and maintenance/cleanout thresholds for each BMP measure. The enclosed BMP Inspection & Maintenance Logs include specific inspection guidelines for each BMP measure and are the documentation portion of this Plan.

Scheduled Inspections

Prior to completion of construction, CMP shall designate a CMP Supervisor and personnel or a contractor as the Site Inspector. Inspection requirements for each individual BMP measure are specified on the Inspection & Maintenance Checklists in Appendix A.

- QUARTERLY: Inspections of stormwater conveyance, control and treatment measures at each Site are to be performed on a quarterly basis throughout the year. Inspections during

winter months may encounter snow and ice cover, frozen ground, snow embankments, dormant vegetation, etc. In these cases, the inspector must use his/her best judgment interpreting these inspection and maintenance requirements, in order to meet both the stated objectives and the intent of the Plan. The inspection should prevent problems and plan for maintenance in advance of the spring thaw (removing snow piles if they obstruct drainage paths, repairing any damage from snow plows, frost heaves, etc.).

- **FOLLOW-UP:** Additional follow-up inspections will be performed, as needed, depending on the results of routine inspections and site conditions, under the direction of the CMP Supervisor.

As-Needed Maintenance

Maintenance is to be performed on an as-needed basis, in accordance with recommendations made by the Site Inspector. Routine maintenance will include the immediate repair of eroded channels or gullies; reseeding or sodding of bare ground; removal of trash, leaves and sediment; and control of vegetation. Maintenance issues associated with specific areas and stormwater facilities at each Site are identified on the Inspection & Maintenance Checklists in Appendix A. Disposal of all sediment, debris, and waste shall be in accordance with Maine Solid Waste Management Rules, Chapter 400.

5-Year Re-Certification

CMP will certify the following to the Maine DEP within three months of the expiration of each five-year interval from the date of issuance of the permit:

- All areas of the project site have been inspected for areas of erosion, and appropriate steps have been taken to permanently stabilize these areas.
- All aspects of the stormwater control system have been inspected for damage, wear, and malfunction, and appropriate steps have been taken to repair or replace the facilities.
- The erosion and stormwater maintenance plan for the site is being implemented as written, or modifications of the plan have been submitted to and approved by the department, and the maintenance log is being maintained.

Housekeeping Plan

Housekeeping entails the control or elimination of pollution not specifically related to soil erosion such as spill prevention, dust control, litter removal and groundwater dewatering. Housekeeping is addressed within this narrative and on sheet 1076-003-005 SH 005 Site Details 6 for the Merrill Road Converter Substation.

GENERAL STANDARDS

The proposed project will result in more than one acre of new impervious area, requiring compliance with the General Standards as described in MeDEP Chapter 500 Section 4C. For the purposes of determining the level of permitting and treatment required, the substation yard is treated as impervious area.

Stormwater Treatment BMPs

At the Merrill Road Converter Substation, stormwater treatment will be accomplished using three separate treatment measures.

The approach to the station within the existing transmission line right of way will be a gravel access road and will be drained using open conveyance channels. Runoff from the road, up to within 50 feet of the substation, will be treated to meet the requirements under ***Section 4.C (5) (C) - Exceptions from the general standards for Linear portion of a project***. The majority of the gravel access road, vegetated developed areas and the drainage ditch running east and west on the north side of the road, will be treated using gravel wetlands with grassed swale and forebay pre-treatment. Gravel access roads and vegetated developed areas sited on wetland areas meet the requirements of ***Section 4.C(5) (E) – Exemption from the general standards for Wetland Road Crossing*** – portions of the road crossing the wetland will include permeable base and are not required to meet the general standards.

The substation yard will be treated in-place via filtration through an 18”-thick layer of gravel below the stone surface. This ***Crushed Stone Substation Surface*** is approved by MeDEP as an adequate treatment for the yard surface for compliance with the General Standards and water quality treatment requirement. Additional paved and rooftop surfaces and additional developed areas around the yard will also be treated in the ***Crushed Stone Substation Surface***. Developed areas outside the substation pad will discharge to open drainage channels around the station pad which will flow to a single ***Underdrained Soil Filter*** where additional detention will be provided. The soil filter/detention basin will discharge through a level spreader to the north of the station. Runoff from the station pad does not require detention and will bypass the soil filter and detention by sheet flowing to the proposed catch basin outside of the soil filter area to the north of the pad. The catch basin will also discharge through a level spreader to the north of the substation. The stormwater treatment measures, and the areas that are treated by each, are depicted on sheet 1076-003-002 SH 004 Post-Development Stormwater Plan.

Crushed Stone Substation Surface

MeDEP has provided yard construction requirements that allow the General Standards requirements to be met for the substation pad, and no further water quality treatment of stormwater from the pad itself is required. The MeDEP letter describing the construction requirements is included with this submission as Appendix B.

The substation surface for each yard is comprised of crushed stone. The crushed stone is supported by 18” of gravel base which acts to filter stormwater runoff as it passes through and into the soil subgrade below. The typical crushed stone surface section is shown in the Substation Yard Sections on sheet 1076-003-005 SH 001 Site Details 1 for the Merrill Road Converter Substation.

In each yard, an additional 2" of crushed stone above the 4" requirement will be provided, creating a 6" layer. The additional storage in the crushed stone layer down slope of the buildings, paved areas and various concrete foundations throughout the yard will allow the crushed stone surface to treat each of these non-soil areas. Calculations for treatment of runoff from the pad have been provided on sheet 1076-003-002 SH 004 Post-Development Stormwater Plan for the Merrill Road Converter Substation. Groundwater dewatering has been addressed with a system of perforated piping, which runs below the frost line in the excavated region of the station pad and around the foundation of the equipment enclosure. The groundwater dewatering system is designed to prevent the migration of groundwater into the 6" station crushed stone and 18" gravel base.

Grassed Underdrain Soil Filter

Runoff from the vegetated developed areas as well as partial sections of the gravel access road will be treated in Grassed Underdrain Soil Filter. Pretreatment will be accomplished by flowing runoff through a vegetated swale and into pre-treatment forebays before entering the filter area.

The Grassed Underdrain Soil Filter is comprised of an 18"-thick layer of a silty sand and organic material mix. The underdrain system consists of 4" perforated pipe within a 12"-thick layer of underdrain material. A detail of the underdrained soil filter is shown on sheet 1076-003-002 SH 002 Stormwater Treatment Plan. Included with soil filters are orifices which discharge the treatment volume from a single outlet with a release time between 24 and 48 hours. Underdrained soil filter sizing and orifice calculations are shown in Appendix C.

Gravel Wetlands

Runoff from the vegetated developed areas as well as partial sections of the gravel access road will be treated in Gravel Wetlands. Pretreatment will be accomplished by flowing runoff through a vegetated swale and into pre-treatment forebays before entering the gravel wetland treatment cell area.

The Gravel Wetland is comprised of an 8" thick layer of a wetland soil mix, 6" transitional gravel layer and 24" crushed stone layer. The underdrain system consists of 6" perpendicular perforated pipe within the crushed stone layer of the gravel wetland. A detail of the gravel wetland is shown on sheet 1076-003-002 SH 005 Stormwater Treatment Plan. Included with gravel wetlands are orifices which discharge the treatment volume from a single outlet with a release time between 24 and 48 hours. Gravel wetland sizing and orifice calculations are shown in Appendix C.

The hydraulic modeling report for the entire project site, including station and access road, is included with this submission in Appendix C. The report was developed based on USDA TR-55 hydraulic analysis methodology. The report illustrates how the site drainage and stormwater management infrastructure will function during the 2-, 10- and 25- year storms. The report also contains the hydrologic calculations for the project. The modeling results were used to confirm that adequate water quality volume (WQV) will be provided below the primary outlet in both the Grassed Underdrain Soil Filter and the Gravel Wetlands.

Permeable Road Base

The gravel access road is proposed through existing wetlands. Where it is possible, the road will be built on a rock sandwich road base which will allow water to freely pass beneath the road to be

discharged downgradient of the road. The rock sandwich will consist of a 12" thick (minimum) layer of 3" – 6" diameter stone sandwiched between layers of permeable filter fabric. The roads with rock sandwich base will be used to cross the existing low-laying wetlands to maintain sheet flow through the wetland areas. The rock sandwich will be constructed to adhere to CH 8.4 of the *BMP Technical Design Manual* (Permeable Base Material).

Per Chapter 500 (Section 4.C(5)(e), Page 12); wetland road crossings that provide a passage for flows are exempt from the requirement to meet the General Standards. Approximately 440 linear feet of access road is exempt from the requirement to meet the General Standards.

Stormwater Treatment Calculations

In order to meet the General Standards, the proposed project must use MeDEP approved treatment measures to treat no less than 95% of the proposed impervious area and 80% of the proposed developed area at the substation site. At the Merrill Road Converter Substation, 99.33% of impervious area is treated, and 83.75% of the developed area is treated. For the linear portion of the project treatment has been reduced to not less than 75% of impervious access road and no less than 50% of the developed area surrounding the road to within 50' of the substation. At the linear portion of the Merrill Road Converter Substation, 78.70% of impervious area is treated, and 54.90% of developed area is treated. Stormwater treatment calculations for the Merrill Road Converter Substation are shown on sheet 1076-003-002 SH 004 Post-Development Stormwater Plan.

FLOODING STANDARD

The project is required to meet the MeDEP Chapter 500 Flooding Standard; an increase of over 3 acres of impervious area requires a decrease in peak stormwater runoff as a result of the proposed development. Additionally, management of stormwater to prevent site and road inundation during a 25-year storm event is provided. The site is situated on HSG Type A, Type C and Type D soils. Pre-developed and post-developed Curve Numbers for the project can be found in Appendix C and on the project drainage area maps (Sheets 1076-003-002 SH 003 and SH 004). The MeDEP letter describing the construction requirements that allow the General Standards requirements to be met for the pad within the *Crushed Stone Substation Surface* also prescribes Curve Numbers for use when calculating runoff from the stone section. Pre-Developed Curve Numbers for the project site range from 72 to 77. MeDEP prescribes developed Curve Numbers for the stone station surface of 55 and 60 over HSG Type C and Type D soils respectively. As existing drainage patterns have been maintained to the extent practicable, the sizes and times of concentration have not been significantly altered with this project. Due to the decreased Curve Numbers across the stone station pad (CN decreased to 55 and 60 for these areas), post-development peak flows were calculated to be less than or relatively equal to the pre-development peak flows from the substation pad without the need for on-site stormwater attenuation. In order to maintain a post-development peak runoff rate at or below the pre-development peak runoff rate for developed landscaped areas outside the pad however, some level of stormwater detention is required. Additional stormwater storage is provided in the grassed underdrain soil filter and gravel wetlands. A maximum of 18" of flooding storage depth above the required water quality volume elevations in the grassed underdrain soil filter and gravel wetlands is proposed. The proposed on-site stormwater detention will provide sufficient capacity to meet the MeDEP Flooding Standard Requirements in Chapter 500 at each analysis point, located at the property line. At each analysis point, stormwater detention or the *Crushed Stone Substation Surface* provides enough treatment to decrease post-development 2 -, 10 - and 25 - year design storm peak

flows to be lower than pre-development peak flows. See the table below for the pre- and post-development peak flows at each analysis point.

Pre-Developed Peak Flow Rates

Analysis Point	2-Year Flow Rate (CFS)	10-Year Flow Rate (CFS)	25-Year Flow Rate (CFS)
A	11.75	26.46	36.58
B	5.09	11.09	15.17
C	5.88	14.62	20.83
D	0.74	1.55	2.09
E	3.31	7.00	9.47

Post-Developed Peak Flow Rates

Analysis Point	2-Year Flow Rate (CFS)	10-Year Flow Rate (CFS)	25-Year Flow Rate (CFS)	Peak 2-Year Flow Rate at Outfall (If Subsheds Present)	Peak 10-Year Flow Rate at Outfall (If Subsheds Present)	Peak 25-Year Flow Rate at Outfall (If Subsheds Present)
A1	5.33	12.43	17.35	11.73	23.66	31.35
A2	7.96	15.32	20.01			
A3	2.99	7.15	10.03			
B	3.66	8.01	10.95	N/A		
C1	0.81	1.70	2.30	5.81	14.08	19.96
C2	0.74	1.40	1.82			
C3	5.79	14.12	19.95			
D	0.68	1.43	1.93	N/A		
E	2.85	6.01	8.13	N/A		

CONCLUSION

The NECEC Project will require a Stormwater Management Permit, and will be required to meet the Basic and General Standards and the Flooding Standard as described in MeDEP Chapter 500. The Basic Standards shall be met at the Merrill Road Converter Substation through Erosion and Sedimentation Control, Inspection and Maintenance, and Housekeeping, as described in this narrative and the attached checklists, logs and plans. The General Standards shall be met at the Merrill Road Converter Substation by using Grassed Underdrain Soil Filters, Gravel Wetlands and the MeDEP approved crushed stone substation yard section, as illustrated on the attached stormwater treatment plans. The Flooding Standard shall be met using storage above the water quality volume within the proposed Grassed Underdrain Soil Filter and Gravel Wetlands.

APPENDIX A – BMP INSPECTION & MAINTENANCE CHECKLISTS AND LOGS

APPENDIX A-1: BMP INSPECTION & MAINTENANCE CHECKLIST

Central Maine Power Company – Merrill Road Converter Substation
Lewiston, Maine

BMP MEASURE	INSPECTION REQUIREMENTS*	MAINTENANCE/CLEANOUT THRESHOLDS
Vegetated Swales	<p>Inspect swale for accumulated sediment, debris and other obstructions.</p> <p>Inspect swales for evidence of erosion, gullies, or slumping of the side slopes.</p> <p>Inspect swales for bare ground/sparse vegetation.</p> <p>Monitor vegetative growth.</p>	<p>Clean as needed and dispose of properly.</p> <p>Repair and re-seed as necessary. Consult engineer if problem persists. Areas of persistent erosion may need to be armored.</p> <p>Re-seed as necessary. Soil may need to be scarified if compacted soils are present.</p> <p>Mow vegetation in swales to roughly six inches at least once and no more than two times a year. To be performed between June 15th and August 30th.</p>
Check Dams	<p>Inspect check dams to ensure the center is lower than the edges.</p> <p>Inspect check dams for stone displacement, erosion, concentrated flow or channelization.</p> <p>Inspect check dams for accumulated sediment, debris or other obstructions.</p>	<p>Repair as necessary.</p> <p>Repair any damaged areas. Consult engineer if problem persists.</p> <p>Clean as needed and dispose of properly. Sediment must be removed before it exceeds one half the original height of the check dam.</p>
Revegetated Areas	<p>Inspect revegetated areas for evidence of erosion, concentrated flow, or channelization.</p> <p>Inspect revegetated areas for bare ground/sparse vegetation.</p>	<p>Repair and re-seed as necessary. Consult engineer if problem persists. Areas of concentrated flow where rills and gullies are present may need to be armored</p> <p>Re-seed as necessary. Soil may need to be scarified if compacted soils are present.</p>
Gravel Access Roads	<p>Inspect access road shoulder for accumulated sand/sediment.</p> <p>Inspect grade on access road and shoulder to ensure stormwater is not impeded by accumulation of materials or false ditches.</p> <p>Inspect access road to ensure that there is no rutting, wash-boarding, frost heaves, potholes, or ponding occurring.</p>	<p>Remove sand/sediment as necessary.</p> <p>Repair grade as necessary.</p> <p>Repair by replacing gravel and re-grading as necessary.</p>

*Inspections are to be performed on a monthly basis with additional follow-up inspections and maintenance as needed.

APPENDIX A-1: BMP INSPECTION & MAINTENANCE CHECKLIST

Central Maine Power Company – Merrill Road Substation
Lewiston, Maine

BMP MEASURE	INSPECTION REQUIREMENTS*	MAINTENANCE/CLEANOUT THRESHOLDS
Grassed Underdrained Soil Filter	<p>Inspect entering swale, basin and outlet structure for accumulated sediment, debris and other obstructions.</p> <p>Inspect filter for evidence of erosion, gullies, or slumping of the side slopes.</p> <p>Inspect filter for bare ground/sparse vegetation.</p> <p>Monitor vegetative growth.</p>	<p>Clean as needed and dispose of properly.</p> <p>Repair and re-seed as necessary. Consult engineer if problem persists. Areas of persistent erosion may need to be armored.</p> <p>Re-seed as necessary. Soil may need to be scarified if filter media becomes compacted.</p> <p>Mow vegetation in impoundment to roughly six inches at least once and no more than two times a year. To be performed between June 15th and August 30th.</p>
Gravel Wetlands	<p>Inspect entering swale, basin and outlet structure for accumulated sediment, debris and other obstructions.</p> <p>Inspect filter for evidence of erosion, gullies, or slumping of the side slopes.</p> <p>Inspect wetland for bare ground/sparse vegetation.</p> <p>Monitor vegetative growth.</p> <p>Monitor water color and check for excessive standing water.</p>	<p>Clean as needed and dispose of properly.</p> <p>Repair and re-seed as necessary. Consult engineer if problem persists. Areas of persistent erosion may need to be armored.</p> <p>Re-seed as necessary. Soil may need to be scarified if filter media becomes compacted.</p> <p>Remove decaying vegetation, litter and debris.</p> <p>Check and clean risers.</p>
Crushed Stone Substation Surface	<p>Inspect crushed stone areas for accumulated sand/sediment.</p> <p>Inspect substation surface to ensure that there is no ponding occurring.</p>	<p>Remove sand/sediment as necessary.</p> <p>Repair by re-grading as necessary.</p>

*Inspections are to be performed on a monthly basis with additional follow-up inspections and maintenance as needed.

APPENDIX A-2: BMP INSPECTION & MAINTENANCE LOG
 Central Maine Power Company – Merrill Road Converter Substation
 Lewiston, Maine

BMP MEASURE (Refer to Appendix B-1 & the O&M Plan)	Inspector(s):			Inspection Type: Monthly [] Follow-up []	Photos Taken: Yes [] No []	Date:
VEGETATED SWALES						
	YES*	NO	INITIALS	OBSERVATIONS	CORRECTIVE ACTIONS/REPAIR ACTIVITY	DATE COMPLETED & BY WHOM (Refer to any contractor service logs)
Swale along Gravel Access Road						
1. Is there an accumulation of sediment, debris and/or other obstructions?						
2. Is there any evidence of erosion, gullies or slumping of the side slopes?						
3. Are there areas of bare ground or sparse vegetation?						
4. Has vegetation been mowed to a length roughly 6" this year?						
Swale along Northwesterly side of yard						
1. Is there an accumulation of sediment, debris and/or other obstructions?						
2. Is there any evidence of erosion, gullies or slumping of the side slopes?						
3. Are there areas of bare ground or sparse vegetation?						
4. Has vegetation been mowed to a length roughly 6" this year?						
CHECK DAMS						
Check Dams in Swale along Gravel Access Road						
1. Are the edges of the check dams higher than the center?						
2. Is there any evidence of stone displacement, erosion, concentrated flow or channelization?						
3. Is there an accumulation of sediment, debris and/or other obstructions?						

APPENDIX A-2: BMP INSPECTION & MAINTENANCE LOG
 Central Maine Power Company – Merrill Road Converter Substation
 Lewiston, Maine

BMP MEASURE (Refer to Appendix B-1 & the O&M Plan)	Inspector(s):			Inspection Type: Monthly [] Follow-up []	Photos Taken: Yes [] No []	Date:
CHECK DAMS (cont.)						
Check Dams in Swale along North, South and East sides of the yard	YES*	NO	INITIALS	OBSERVATIONS	CORRECTIVE ACTIONS/REPAIR ACTIVITY	DATE COMPLETED & BY WHOM (Refer to any contractor service logs)
1. Are the edges of the check dams higher than the center?						
2. Is there any evidence of stone displacement, erosion, concentrated flow or channelization?						
3. Is there an accumulation of sediment, debris and/or other obstructions?						
REVEGETATED AREAS						
Revegetated Areas along Access Road						
1. Is there any evidence of erosion, concentrated flow or channelization?						
2. Are there areas of bare ground or sparse vegetation?						
Revegetated Areas on all sides of the station						
1. Is there any evidence of erosion, concentrated flow or channelization?						
2. Are there areas of bare ground or sparse vegetation?						
GRAVEL ACCESS ROADS						
Access Road to Entrance						
1. Is there an accumulation of sand and/or sediment in the road shoulder?						
2. Does the grade across the road section allow stormwater to drain off the roadway?						
3. Are there any signs of rutting, wash-boarding, frost heaves, potholes or ponding?						

APPENDIX A-2: BMP INSPECTION & MAINTENANCE LOG
 Central Maine Power Company – Merrill Road Converter Substation
 Lewiston, Maine

BMP MEASURE (Refer to Appendix B-1 & the O&M Plan)	Inspector(s):			Inspection Type: Monthly [] Follow-up []	Photos Taken: Yes [] No []	Date:
GRASSED UNDERDRAINED SOIL FILTER	YES*	NO	INITIALS	OBSERVATIONS	CORRECTIVE ACTIONS/REPAIR ACTIVITY	DATE COMPLETED & BY WHOM (Refer to any contractor service logs)
West side of station yard						
1. Is there an accumulation of sand and/or sediment in the swale, forebay or basin?						
2. Is there any evidence of erosion, gullies or slumping of the side slopes?						
3. Are there areas of bare ground or sparse vegetation?						
GRAVEL WETLANDS						
Along northern side of access road						
1. Is there an accumulation of sand and/or sediment in the swale, forebay or wetland?						
2. Is there any evidence of erosion, gullies or slumping of the side slopes?						
3. Are there areas of bare ground or sparse vegetation?						
4. Is there discolored or standing water?						
CRUSHED STONE SUBSTATION SURFACE						
Fenced-in area of the Substation and aprons						
1. Is there an accumulation of sand/sediment in crushed stone areas?						

APPENDIX B – LETTER FROM MEDEP TO CMP



STATE OF MAINE
DEPARTMENT OF ENVIRONMENTAL PROTECTION

JUN 11 2008

JOHN ELIAS BALDACCI
GOVERNOR

DAVID P. LITTELL
COMMISSIONER

June 5, 2008

Roy Koster
Central Maine Power
83 Edison Drive
Augusta, ME 04336

RE: DEP Stormwater Management Regulations and how they apply to
Central Maine Power Company Substations and Switchyards

Dear Mr. Koster:

I am writing to provide clarification on how substations and switchyards designed by Central Maine Power Company (CMP) can meet DEP Stormwater Management rules, Chapter 500 and the Site Location of Development Law. This letter supersedes a previous DEP letter on this subject dated February 29, 2008 and is a follow-up to further discussions between CMP and DEP staff.

Based on the report prepared by John Simon of Balance Engineering, dated March 8, 2008, regarding the stormwater runoff coefficient at CMP substations and switchyards, the required gravel fill and surface nature of these structures performs differently than most common construction practices and a modeling variance will be allowed for CMP substations and switchyards as follows:

When Flooding Standard requirements apply to a CMP project, modeling must demonstrate that peak runoff from the substation structure does not exceed predevelopment flow rates at the property line. Because of the permeability plus storage within the gravel fill and roughness of the crushed rock surface, the curve number (CN) specified in John Simon's report (March 2008) may be used for the substation area. As reported, a CN of 55 may be used for substations and switchyards that are built on areas that are mapped as HSG "A", "B", and "C", and a CN of 60 must be used when the area is mapped as HSG "D" for the HydroCAD model. However, all impervious surfaces will have to be added for an averaged curve number.

The General Standards of Chapter 500 (water quality) will be considered as met by the CMP substation/switchyard design specifications as long as the structure includes the typical CMP substation profile overlaying the natural ground surface. The soil layers within the CMP substation profile consist of 4 inches of crushed stone, 50:50 mix of 1.5"

AUGUSTA
17 STATE HOUSE STATION
AUGUSTA, MAINE 04333-0017
(207) 287-7688 FAX: (207) 287-7826
RAY BLDG., HOSPITAL ST.

BANGOR
106 HOGAN ROAD
BANGOR, MAINE 04401
(207) 941-4570 FAX: (207) 941-4584

PORTLAND
312 CANCO ROAD
PORTLAND, MAINE 04103
(207) 822-6300 FAX: (207) 822-6303

PRESQUE ISLE
1235 CENTRAL DRIVE, SKYWAY PARK
PRESQUE ISLE, MAINE 04769-2094
(207) 764-0477 FAX: (207) 760-3143

and 0.75" diameter stone overlaying 18 inches or more of gravel fill, MDOT 703.06 Type A. Saturation within the granular fill will detain and provide treatment for the one-inch design standard under that requirement. Groundwater can never be any higher than 18 inches below the top of the gravel fill. Other treatment considerations will need to be provided for all impervious structures anticipated on the substation and switchyard and for the roadway.

The Basic Standards of Chapter 500 (erosion and sedimentation control, inspection and maintenance, and housekeeping) will be met by the standard CMP substation and switchyard design specification and erosion control/construction plan as developed by CMP for each Stormwater Management application. These are minimum erosion control measures that will need to be maintained until the site is fully stabilized. However, based on site and weather conditions during construction, additional erosion control measures may be needed.

While there are several ways to approach the design standards discussed above, these must be considered the minimum requirements in meeting the Stormwater Management and Site Location of Development Laws. However, in some situations where the local hydrology and site conditions warrant more resource protection, additional BMPs may be required. Also, the access drive and associated roadside swales are included in the disturbed area for permitting purposes and the treatment of these areas must be addressed separately from the substation or switchyard and be treated with standard practices. The natural hydrology of these areas will need to be maintained and will have to meet all applicable standards as established in Chapter 500 (page 11, Section 5).

I hope this addresses your request and will make the DEP permitting process more straight forward. If you have further questions, please contact Marianne Hubert at (207) 287-4140.

Sincerely,

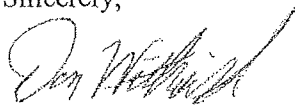

Don Witherill, Director
Watershed Management Division
Bureau of Land and Water Quality

Cc: Marianne Hubert, PE, DEP program manager
Andy Fisk, DEP L&W Bureau Director
Dan Butler, PE, TRC
Gerry Mirabile, CMP

APPENDIX C – STORMWATER CALCULATIONS

Calculations for Grassed Underdrain Soil Filters						
*Based upon MeDEP Stormwater BMPs Chapter 7.1 - Grassed Underdrain Soil Filters						
Name of Filter	Impervious Catchment (AC)	Pervious Developed Catchment (AC)	Surface Area Required (SF)	Designed Surface Area of Filter (SF)	WQv Required (CF)	¹ WQv Provided (CF)
Filter-1	0.17	1.87	1999.404	2178	3332.34	3542

¹Filter-1 WQv depth = 1.10'

Calculations for Grassed Underdrain Soil Filters							
Orifice Sizing, Underdrain Detention							
Name of Filter	WQv Required (CF)	Detention Time (HR)	Flow Rate (CFS)	Average Head (FT)	Orifice Coefficient	Orifice Area (SF)	Orifice Diameter (IN) ³
Filter-1	3332.34	36	0.0257125	1.92	0.614	0.003766018	0.830954986

³Constructed Filter-1 Orifice Diameter = 7/8" to allow detention time between 24 - 48 hrs

Calculations for Gravel Wetlands								
*Based upon MeDEP Stormwater BMPs Chapter 7.4 - Gravel Wetlands								
Name of Gravel Wetland	Impervious Catchment (AC)	Pervious Developed Catchment (AC)	Min. Surface Area (SF)	Designed Surface Area of Filter (SF)	WQv Required (CF)	¹ Treatment Cell Volume Required (CF)	Treatment Cell Volume Provided (CF)	² WQv Provided (CF)
Wetland-C1	0.19	0.42	779.724	2183	1299.54	1169.586	1424	1582.206
Wetland-C2	0.4	0.31	1141.272	2828	1902.12	1711.908	1810	2011.091

¹Treatment Cell Volume Required = 45% of WQv Required Per Wetland Cell (2 Cells Per BMP)

²WetlandC-1 WQv Depth = 0.57', WetlandC-2 WQv Depth = 0.57'

Calculations for Gravel Wetlands							
Orifice Sizing, Underdrain Detention							
Name of Filter	WQv Required (CF)	Detention Time (HR)	Flow Rate (CFS)	Average Head (FT)	Orifice Coefficient	Orifice Area (SF)	Orifice Diameter (IN) ³
Wetland-C1	1299.54	36	0.010027315	0.62	0.614	0.002584506	0.688374946
Wetland-C2	1902.12	36	0.014676852	0.62	0.614	0.003782908	0.832816241

³Constructed WetlandC-1 Orifice Diameter = 7/8", WetlandC-2 Orifice Diameter = 7/8" to allow detention time between 24 - 48 hrs

Calculations for Level Spreaders			
*Based Upon MeDEP Storm water BMPs Chapter 8.3 - Level Spreaders			
Level Spreader #	Peak 10-Year Flow Rate	¹ Calculated Lip Length (LF)	² Lip Length Used (LF)
1	0.36	1.44	10
2	³ 2.00	8.00	10
3	1.84	7.36	10
4	2.19	8.76	10
⁴ Pipe Outlet Protection from CB-1	19.04	76.16	N/A

¹ Lip Length Based Upon 0.25 LF / CFS

² Based Upon Minimum Lip Length of 10 LF

³ 2 cfs (Approx ¼ of DA B)

⁴ Plunge pool designed in accordance with MeDEP Erosion Control BMPs H.2 Pipe Outlet Protection

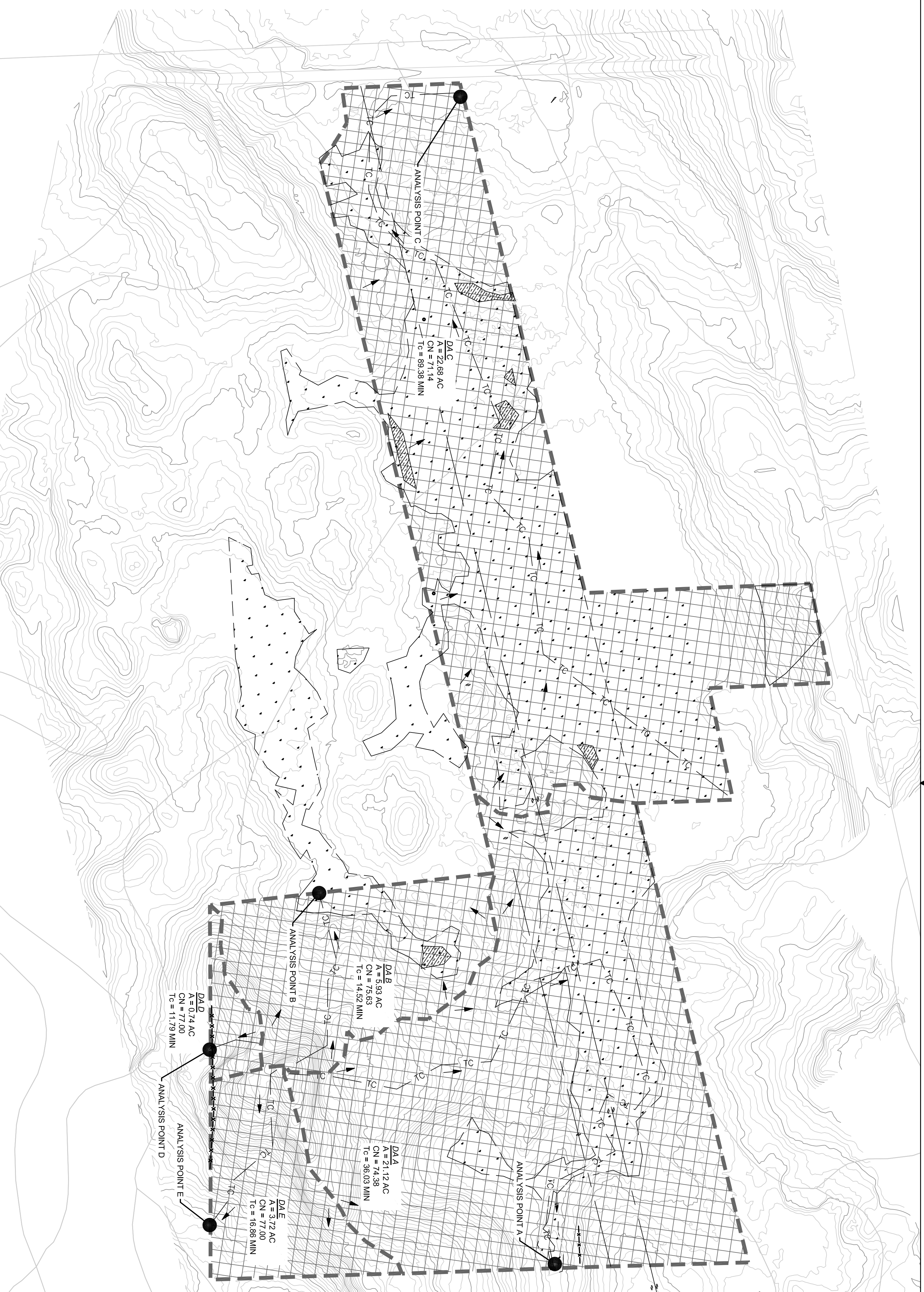

LEGEND

- 750 --- EX. MAJOR CONTOUR
- 744 --- EX. MINOR CONTOUR
- TC --- EX. TIME OF CONCENTRATION
- H2O (S) --- EX. SOIL BOUNDARY
- H2O (C S) --- EX. OVERHEAD UTILITY
- EX. FLOW DIRECTION ARROW
- EX. DRAINAGE BOUNDARY
- EX. PROPERTY BOUNDARY
- EX. WETLAND
- EX. VERNAL POOL
- ANALYSIS POINT
- EX. WOODS

DRAINAGE AREA	2 - YEAR FLOW RATE (CFS)	10 - YEAR FLOW RATE (CFS)	25 - YEAR FLOW RATE (CFS)
A	11.75	26.46	36.58
B	5.09	11.09	15.17
C	5.88	14.82	20.83
D	0.74	1.55	2.09
E	3.31	7.00	9.47

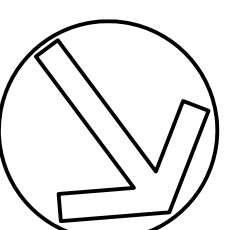
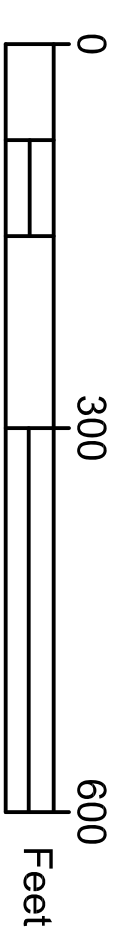

**ISSUED FOR PERMITTING
NOT FOR CONSTRUCTION
08/09/18**

REV.	DESCRIPTION	DATE	BY	CK	APP	OWNER ENGINEER	APPROVAL STAMP	FE Stamp
B	ACCESS ROAD ALIGNMENT REVISIONS	07/12/18	TJG	KRV				
C	STORMWATER MANAGEMENT REVISIONS	08/09/18	TJG	KRV				
						DRAWING PREPARED BY:	ACCEPTED BY CE:	

REV.	DATE	BY	DESCRIPTION

**USA ENGINEERING
Property of Liverpool, USA**

**CMP
BERDREOLA - USA**

PRE-DEVELOPMENT STORMWATER PLAN

SH 3 OF 5

MERRILL ROAD/1076 LEWISTON, ME

DR: TIG
CK: KRV
NO. 1076-003-002

SCALE: 1" = 150'
FILE: 1076-003-002\$R\$H03.DWG

REV. C

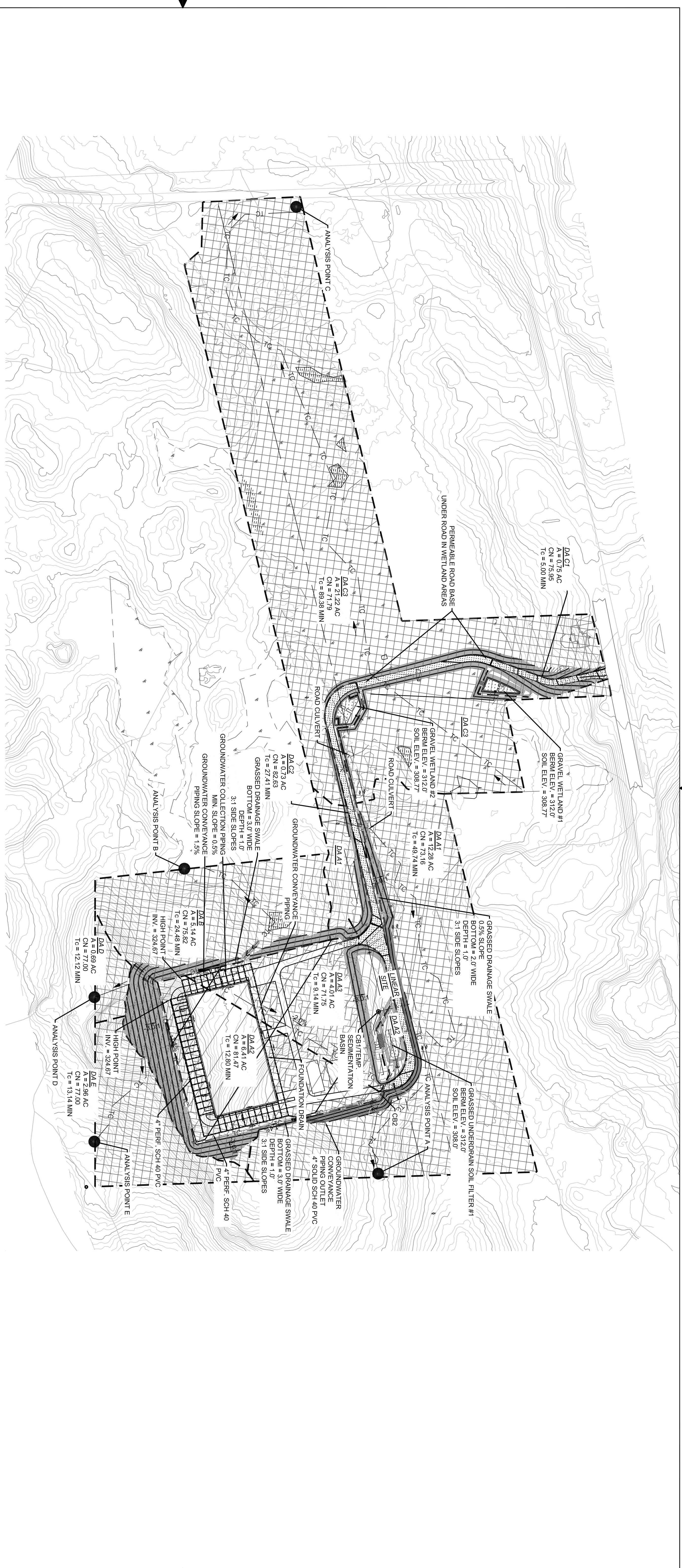

PROPOSED CONDITIONS HYDRAULIC SUMMARY

DRAINAGE AREA	2-YEAR FLOW RATE (CFS)	10-YEAR FLOW RATE (CFS)	25-YEAR FLOW RATE (CFS)	PEAK 2-YEAR FLOW RATE AT ANALYSIS POINT (IF SUBSHEDS PRESENT)	PEAK 10-YEAR FLOW RATE AT ANALYSIS POINT (IF SUBSHEDS PRESENT)	PEAK 25-YEAR FLOW RATE AT ANALYSIS POINT (IF SUBSHEDS PRESENT)
A1	5.33	12.43	17.35			
A2	7.96	15.32	20.01		23.66	31.35
A3	2.99	7.15	10.03			
B	3.66	8.01	10.95			
C1	0.81	1.70	2.30			
C2	0.74	1.40	1.82	5.81	14.08	19.96
C3	5.79	14.12	19.95			
D	0.88	1.43	1.93			
E	2.85	6.01	8.13			

STORMWATER TREATMENT REQUIREMENTS (% OF TREATED AREA)

LAND TYPE	STATION	STATION % TREATED	LINEAR	LINEAR % TREATED
IMPERVIOUS TOTAL	7.15 AC		0.96 AC	
IMPERVIOUS TREATED	7.10 AC	99.33%	0.76 AC	78.70%
DEVELOPED TOTAL	10.71 AC		2.71 AC	
DEVELOPED TREATED	8.97 AC	83.75%	1.49 AC	54.90%

IMPERVIOUS TOTAL DOES NOT INCLUDE 0.20 ACRES OF EXEMPTED WETLAND ROAD CROSSING AREA WITH PERMEABLE ROAD BASE
 DEVELOPED TOTAL DOES NOT INCLUDE 0.47 ACRES OF EXEMPTED WETLAND ROAD CROSSING AREA WITH PERMEABLE ROAD BASE
 DEVELOPED AREA INCLUDES BOTH IMPERVIOUS AND LANDSCAPED SURFACES

LEGEND

- 750 EX. MAJOR CONTOUR
- 744 EX. MINOR CONTOUR
- H/D (Solia) EX. SOIL BOUNDARY
- H/C (Solia) EX. OVERHEAD UTILITY
- EX. PROPERTY BOUNDARY
- EX. WETLAND
- EX. VERNAL POOL
- EX. WOODS
- PROP. DEVELOPED GRASS
- PROP. UNDERDRAIN SOIL FILTER/GRAVEL WETLAND
- PROP. MAJOR CONTOUR
- PROP. MINOR CONTOUR
- PROP. TIME OF CONCENTRATION
- PROP. FLOW DIRECTION ARROW
- PROP. DRAINAGE BOUNDARY
- ANALYSIS POINT
- PROP. CULVERT/PIPING
- PROP. SITE/LINEAR DEMARCATION
- 750 PROP. MAJOR CONTOUR
- 744 PROP. MINOR CONTOUR
- TC PROP. TIME OF CONCENTRATION
- PROP. FLOW DIRECTION ARROW
- PROP. DRAINAGE BOUNDARY
- ANALYSIS POINT
- PROP. CULVERT/PIPING
- PROP. SITE/LINEAR DEMARCATION
- PROP. MAJOR CONTOUR
- PROP. MINOR CONTOUR
- PROP. TIME OF CONCENTRATION
- PROP. FLOW DIRECTION ARROW
- PROP. DRAINAGE BOUNDARY
- ANALYSIS POINT
- PROP. CULVERT/PIPING
- PROP. SITE/LINEAR DEMARCATION
- PROP. MAJOR CONTOUR
- PROP. MINOR CONTOUR
- PROP. TIME OF CONCENTRATION
- PROP. FLOW DIRECTION ARROW
- PROP. DRAINAGE BOUNDARY
- ANALYSIS POINT
- PROP. CULVERT/PIPING
- PROP. SITE/LINEAR DEMARCATION
- PROP. MAJOR CONTOUR
- PROP. MINOR CONTOUR
- PROP. TIME OF CONCENTRATION
- PROP. FLOW DIRECTION ARROW
- PROP. DRAINAGE BOUNDARY
- ANALYSIS POINT
- PROP. CULVERT/PIPING
- PROP. SITE/LINEAR DEMARCATION
- PROP. MAJOR CONTOUR
- PROP. MINOR CONTOUR
- PROP. TIME OF CONCENTRATION
- PROP. FLOW DIRECTION ARROW
- PROP. DRAINAGE BOUNDARY
- ANALYSIS POINT
- PROP. CULVERT/PIPING
- PROP. SITE/LINEAR DEMARCATION
- PROP. MAJOR CONTOUR
- PROP. MINOR CONTOUR
- PROP. TIME OF CONCENTRATION
- PROP. FLOW DIRECTION ARROW
- PROP. DRAINAGE BOUNDARY
- ANALYSIS POINT
- PROP. CULVERT/PIPING
- PROP. SITE/LINEAR DEMARCATION

REV.	DESCRIPTION	DATE	BY	CK	APP	OWNER ENGINEER
B	MEDEP PERMIT SET COMMENT REVISIONS	05/29/18	TJG	KRV		
C	ACCESS ROAD ALIGNMENT REVISIONS	07/27/18	TJG	KRV		
D	STORMWATER MANAGEMENT REVISIONS	08/09/18	TJG	KRV		

DRAWING PREPARED BY: _____

ACCEPTED BY: _____

REV.	DATE	BY	DESCRIPTION

USA ENGINEERING
 CONFIDENTIAL, PROPRIETARY and TRADE SECRET INFORMATION
 Property of IBERDROLA, USA

IBERDROLA - USA

CMP

POST-DEVELOPMENT STORMWATER PLAN
 SH 4 OF 5
 MERRILL ROAD/1076
 LEWISTON, ME
 SCALE: 1" = 150'
 FILE: 1076-003-002\$R001.DWG
 1076-003-002

ISSUED FOR PERMITTING
 NOT FOR CONSTRUCTION
 08/09/18

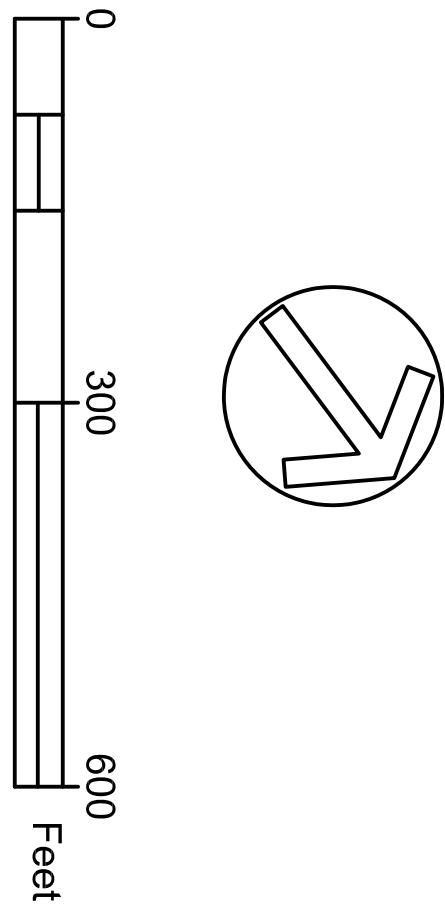

Project Description

File Name Existing Conditions.SPF

Project Options

Flow Units CFS
 Elevation Type Elevation
 Hydrology Method SCS TR-55
 Time of Concentration (TOC) Method SCS TR-55
 Link Routing Method Kinematic Wave
 Enable Overflow Ponding at Nodes YES
 Skip Steady State Analysis Time Periods NO

Analysis Options

Start Analysis On Jul 13, 2017 00:00:00
 End Analysis On Jul 14, 2017 00:00:00
 Start Reporting On Jul 13, 2017 00:00:00
 Antecedent Dry Days 0 days
 Runoff (Dry Weather) Time Step 0 01:00:00 days hh:mm:ss
 Runoff (Wet Weather) Time Step 0 00:05:00 days hh:mm:ss
 Reporting Time Step 0 00:05:00 days hh:mm:ss
 Routing Time Step 30 seconds

Number of Elements

	Qty
Rain Gages	1
Subbasins.....	5
Nodes.....	5
<i>Junctions</i>	0
<i>Outfalls</i>	5
<i>Flow Diversions</i>	0
<i>Inlets</i>	0
<i>Storage Nodes</i>	0
Links.....	0
<i>Channels</i>	0
<i>Pipes</i>	0
<i>Pumps</i>	0
<i>Orifices</i>	0
<i>Weirs</i>	0
<i>Outlets</i>	0
Pollutants	0
Land Uses	0

Rainfall Details

SN	Rain Gage ID	Data Source	Data Source ID	Rainfall Type	Rain Units	State	County	Return Period (years)	Rainfall Depth (inches)	Rainfall Distribution
1	Rain Gage-01	Time Series	TS-02	Cumulative	inches	Maine	Androscoggin	2	3.04	SCS Type III 24-hr

Subbasin Summary

Subbasin ID	Area (ac)	Weighted Curve Number	Total Rainfall (in)	Total Runoff (in)	Total Runoff Volume (ac-in)	Peak Runoff (cfs)	Time of Concentration (days hh:mm:ss)
A	21.12	74.38	3.04	0.95	20.15	11.75	0 00:36:01
B	5.93	75.63	3.04	1.02	6.05	5.09	0 00:14:31
C	22.68	71.14	3.04	0.79	17.92	5.88	0 01:29:22
D	0.74	77.00	3.04	1.10	0.81	0.74	0 00:11:47
E	3.72	77.00	3.04	1.10	4.09	3.31	0 00:16:51

Node Summary

Element ID	Element Type	Invert Elevation
		(ft)
OUT-A	Outfall	298.00
OUT-B	Outfall	310.00
OUT-C	Outfall	298.00
OUT-D	Outfall	338.00
OUT-E	Outfall	298.00

Subbasin Hydrology

Subbasin : A

Input Data

Area (ac) 21.12
Weighted Curve Number 74.38
Rain Gage ID Rain Gage-01

Composite Curve Number

Soil/Surface Description	Area (acres)	Soil Group	Curve Number
Woods, Good	7.92	C	70.00
Woods, Good	13.20	D	77.00
Composite Area & Weighted CN	21.12		74.38

Time of Concentration

TOC Method : SCS TR-55

Sheet Flow Equation :

$$T_c = (0.007 * ((n * L_f)^{0.8})) / ((P^{0.5}) * (S_f^{0.4}))$$

Where :

T_c = Time of Concentration (hr)
n = Manning's roughness
L_f = Flow Length (ft)
P = 2 yr, 24 hr Rainfall (inches)
S_f = Slope (ft/ft)

Shallow Concentrated Flow Equation :

V = 16.1345 * (S_f^{0.5}) (unpaved surface)
V = 20.3282 * (S_f^{0.5}) (paved surface)
V = 15.0 * (S_f^{0.5}) (grassed waterway surface)
V = 10.0 * (S_f^{0.5}) (nearly bare & untilled surface)
V = 9.0 * (S_f^{0.5}) (cultivated straight rows surface)
V = 7.0 * (S_f^{0.5}) (short grass pasture surface)
V = 5.0 * (S_f^{0.5}) (woodland surface)
V = 2.5 * (S_f^{0.5}) (forest w/heavy litter surface)
T_c = (L_f / V) / (3600 sec/hr)

Where:

T_c = Time of Concentration (hr)
L_f = Flow Length (ft)
V = Velocity (ft/sec)
S_f = Slope (ft/ft)

Channel Flow Equation :

V = (1.49 * (R^{2/3}) * (S_f^{0.5})) / n
R = A_q / W_p
T_c = (L_f / V) / (3600 sec/hr)

Where :

T_c = Time of Concentration (hr)
L_f = Flow Length (ft)
R = Hydraulic Radius (ft)
A_q = Flow Area (ft²)
W_p = Wetted Perimeter (ft)
V = Velocity (ft/sec)
S_f = Slope (ft/ft)
n = Manning's roughness

	Subarea	Subarea	Subarea
	A	B	C
Sheet Flow Computations			
Manning's Roughness :	.6	0.00	0.00
Flow Length (ft) :	100	0.00	0.00
Slope (%) :	32.75	0.00	0.00
2 yr, 24 hr Rainfall (in) :	3.00	0.00	0.00
Velocity (ft/sec) :	0.17	0.00	0.00
Computed Flow Time (min) :	10.03	0.00	0.00
	Subarea	Subarea	Subarea
	A	B	C
Shallow Concentrated Flow Computations			
Flow Length (ft) :	870	1086	0.00
Slope (%) :	5.65	.76	0.00
Surface Type :	Woodland		Unpaved
Velocity (ft/sec) :	1.19	1.31	0.00
Computed Flow Time (min) :	12.18	13.82	0.00
Total TOC (min)	36.03		

Subbasin Runoff Results

Total Rainfall (in)	3.04
Total Runoff (in)	0.95
Peak Runoff (cfs)	11.75
Weighted Curve Number	74.38
Time of Concentration (days hh:mm:ss)	0 00:36:02

Subbasin : A

Rainfall Intensity Graph

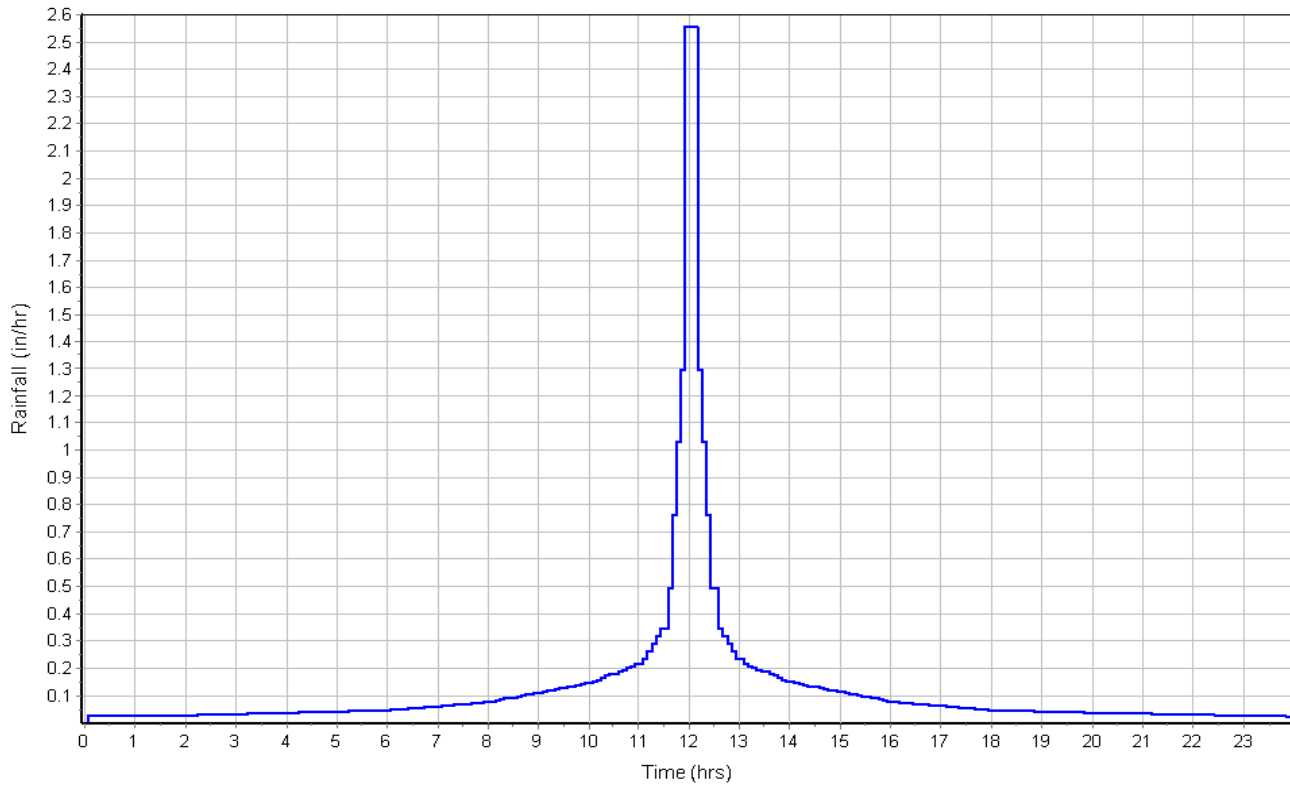

Runoff Hydrograph

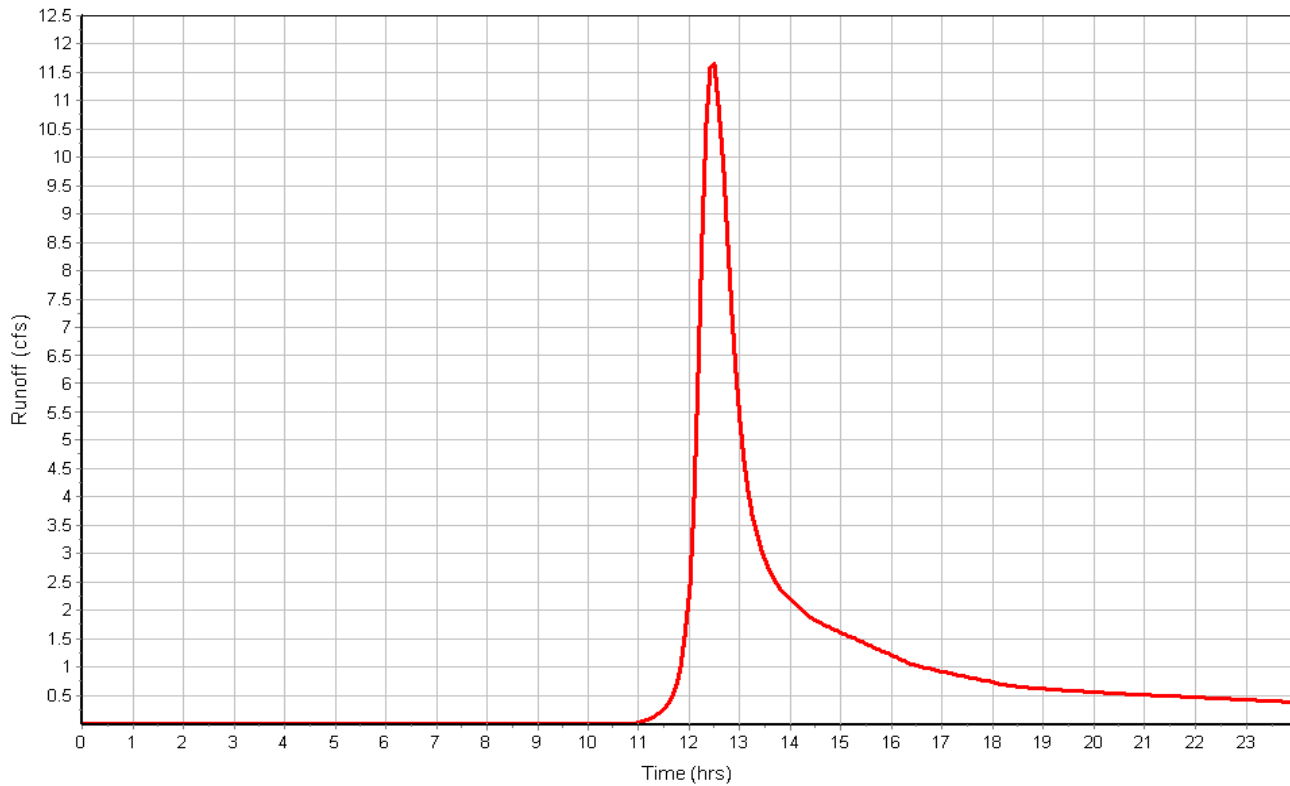

Subbasin : B

Input Data

Area (ac) 5.93
 Weighted Curve Number 75.63
 Rain Gage ID Rain Gage-01

Composite Curve Number

Soil/Surface Description	Area (acres)	Soil Group	Curve Number
Woods, Good	1.16	C	70.00
Woods, Good	4.77	D	77.00
Composite Area & Weighted CN	5.93		75.63

Time of Concentration

	Subarea A	Subarea B	Subarea C
Sheet Flow Computations			
Manning's Roughness :	.6	0.00	0.00
Flow Length (ft) :	100	0.00	0.00
Slope (%) :	34	0.00	0.00
2 yr, 24 hr Rainfall (in) :	3.00	0.00	0.00
Velocity (ft/sec) :	0.17	0.00	0.00
Computed Flow Time (min) :	9.88	0.00	0.00
Shallow Concentrated Flow Computations			
Flow Length (ft) :	440	0.00	0.00
Slope (%) :	10	0.00	0.00
Surface Type :	Woodland	Unpaved	Unpaved
Velocity (ft/sec) :	1.58	0.00	0.00
Computed Flow Time (min) :	4.64	0.00	0.00
Total TOC (min)	14.52		

Subbasin Runoff Results

Total Rainfall (in) 3.04
 Total Runoff (in) 1.02
 Peak Runoff (cfs) 5.09
 Weighted Curve Number 75.63
 Time of Concentration (days hh:mm:ss) 0 00:14:31

Subbasin : B

Rainfall Intensity Graph

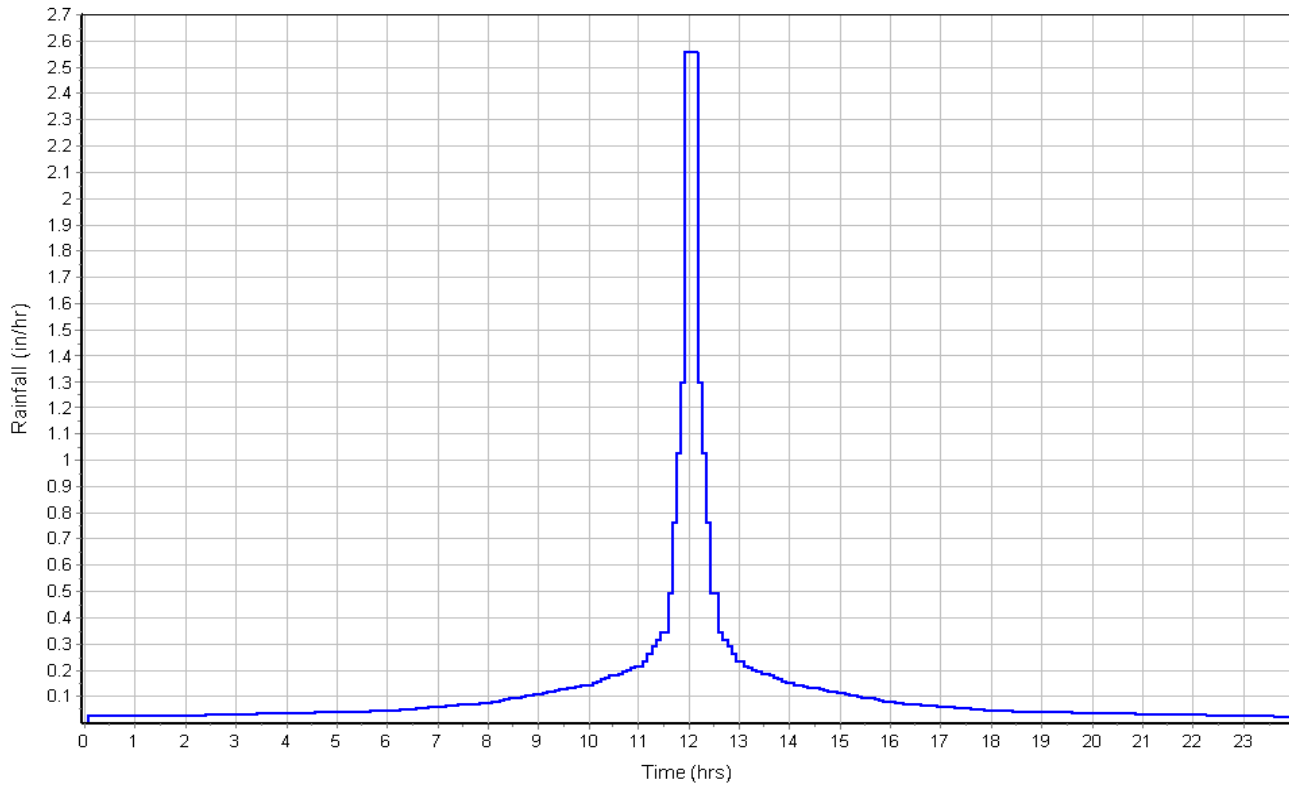

Runoff Hydrograph

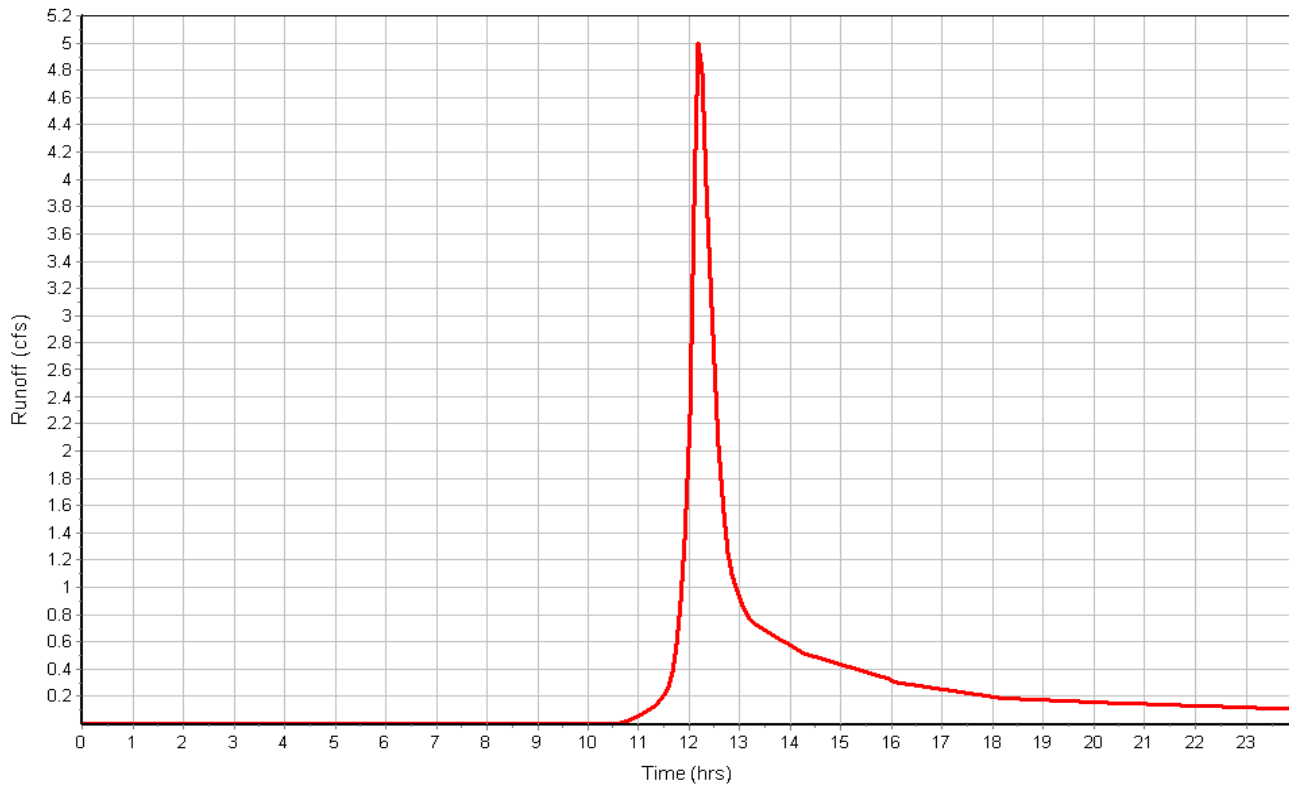

Subbasin : C

Input Data

Area (ac) 22.68
 Weighted Curve Number 71.14
 Rain Gage ID Rain Gage-01

Composite Curve Number

Soil/Surface Description	Area (acres)	Soil Group	Curve Number
Woods, Good	14.42	C	70.00
Woods, Good	7.58	D	77.00
Woods, Good	0.68	A	30.00
Composite Area & Weighted CN	22.68		71.14

Time of Concentration

	Subarea		
	A	B	C
Sheet Flow Computations			
Manning's Roughness :	.6	0.00	0.00
Flow Length (ft) :	100	0.00	0.00
Slope (%) :	.47	0.00	0.00
2 yr, 24 hr Rainfall (in) :	3.00	0.00	0.00
Velocity (ft/sec) :	0.03	0.00	0.00
Computed Flow Time (min) :	54.75	0.00	0.00
Shallow Concentrated Flow Computations			
Flow Length (ft) :	2140	0.00	0.00
Slope (%) :	.47	0.00	0.00
Surface Type :	Grassed waterway	Unpaved	Unpaved
Velocity (ft/sec) :	1.03	0.00	0.00
Computed Flow Time (min) :	34.63	0.00	0.00
Total TOC (min)	89.38		

Subbasin Runoff Results

Total Rainfall (in) 3.04
 Total Runoff (in) 0.79
 Peak Runoff (cfs) 5.88
 Weighted Curve Number 71.14
 Time of Concentration (days hh:mm:ss) 0 01:29:23

Subbasin : C

Rainfall Intensity Graph

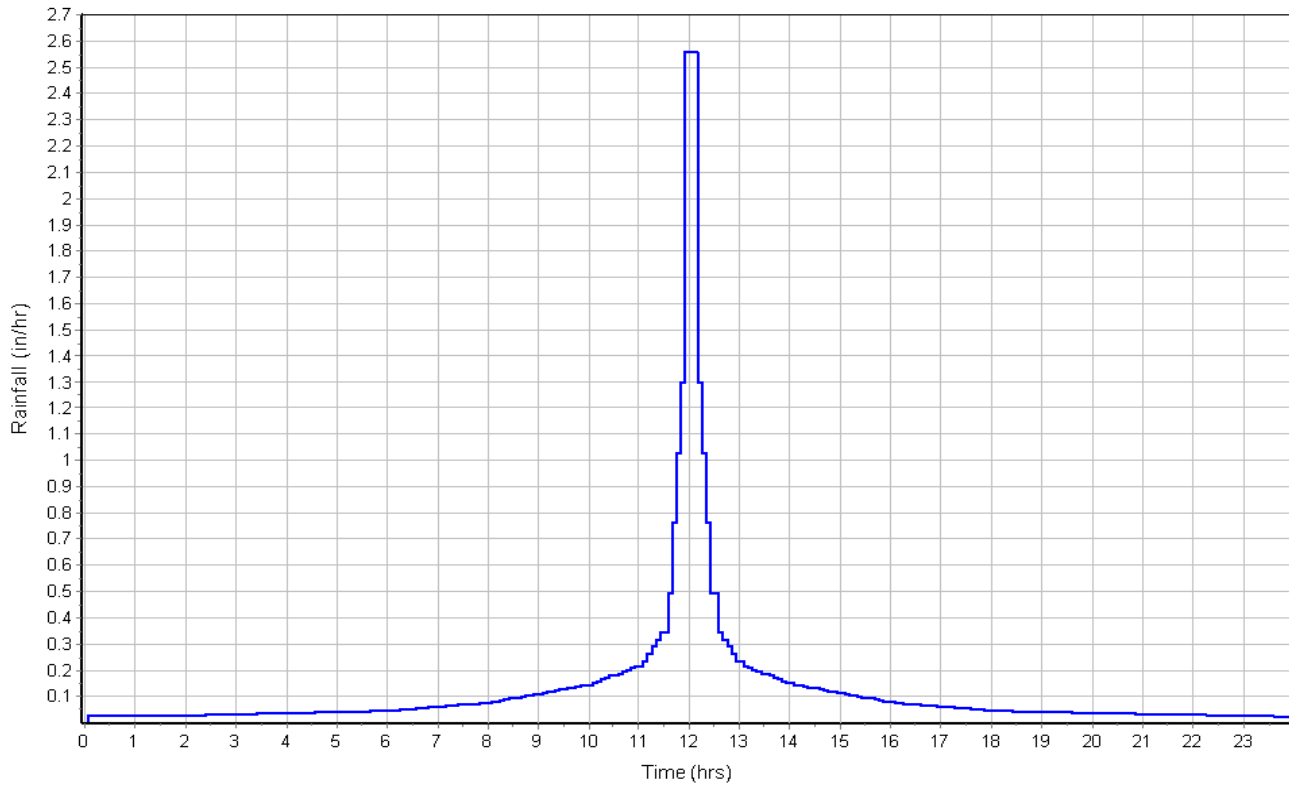

Runoff Hydrograph

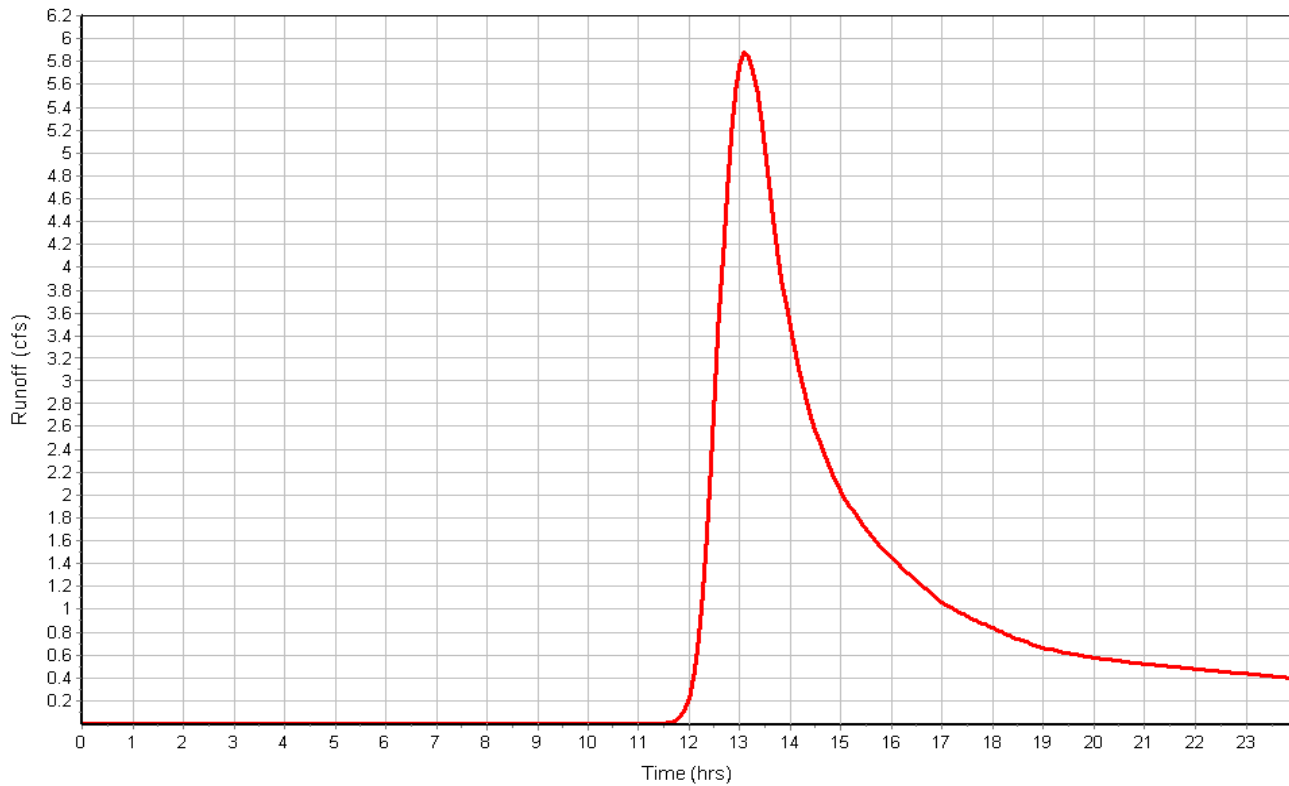

Subbasin : D

Input Data

Area (ac) 0.74
 Weighted Curve Number 77.00
 Rain Gage ID Rain Gage-01

Composite Curve Number

Soil/Surface Description	Area (acres)	Soil Group	Curve Number
Woods, Good	0.74	D	77.00
Composite Area & Weighted CN	0.74		77.00

Time of Concentration

Sheet Flow Computations	Subarea	Subarea	Subarea
	A	B	C
Manning's Roughness :	.6	0.00	0.00
Flow Length (ft) :	100	0.00	0.00
Slope (%) :	23.2	0.00	0.00
2 yr, 24 hr Rainfall (in) :	3.00	0.00	0.00
Velocity (ft/sec) :	0.14	0.00	0.00
Computed Flow Time (min) :	11.51	0.00	0.00

Shallow Concentrated Flow Computations	Subarea	Subarea	Subarea
	A	B	C
Flow Length (ft) :	33	0.00	0.00
Slope (%) :	14.75	0.00	0.00
Surface Type :	Woodland	Unpaved	Unpaved
Velocity (ft/sec) :	1.92	0.00	0.00
Computed Flow Time (min) :	0.29	0.00	0.00
Total TOC (min)	11.79		

Subbasin Runoff Results

Total Rainfall (in) 3.04
 Total Runoff (in) 1.10
 Peak Runoff (cfs) 0.74
 Weighted Curve Number 77.00
 Time of Concentration (days hh:mm:ss) 0 00:11:47

Subbasin : D

Rainfall Intensity Graph

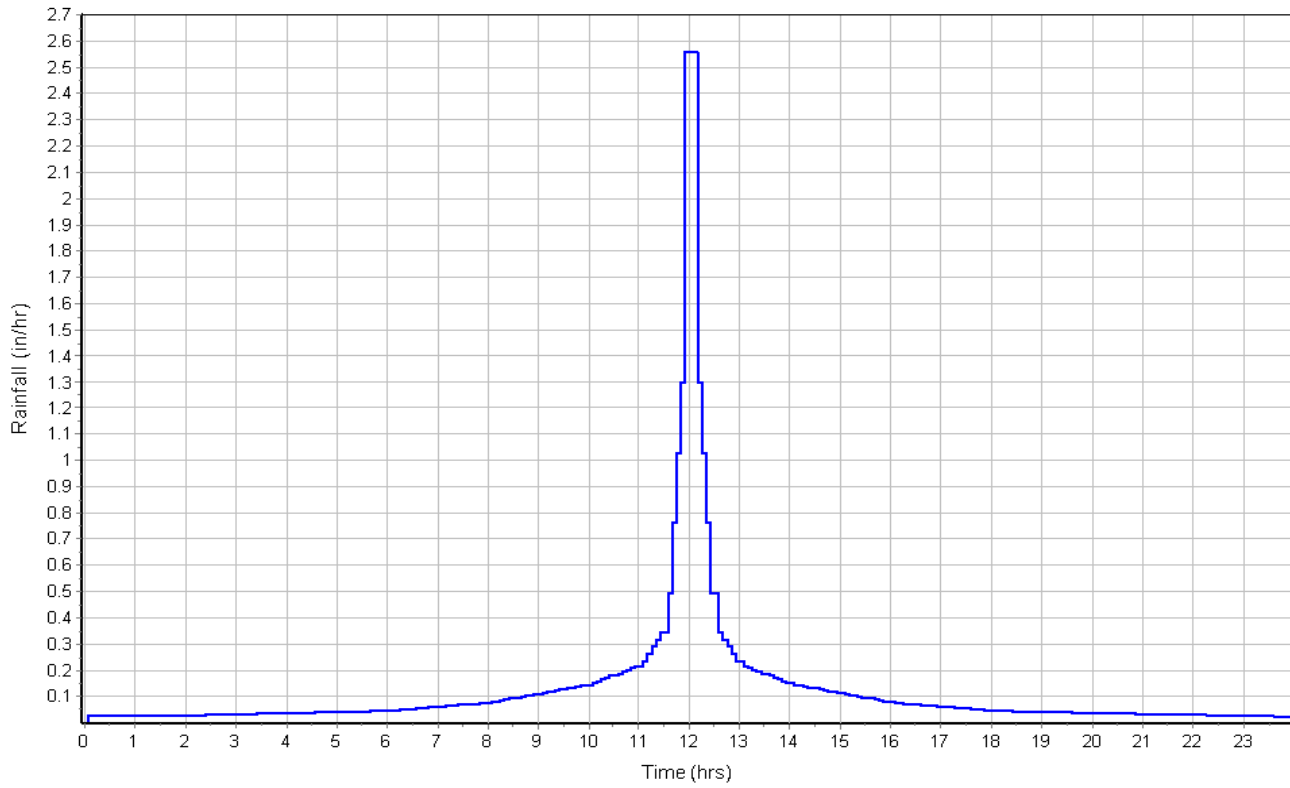

Runoff Hydrograph

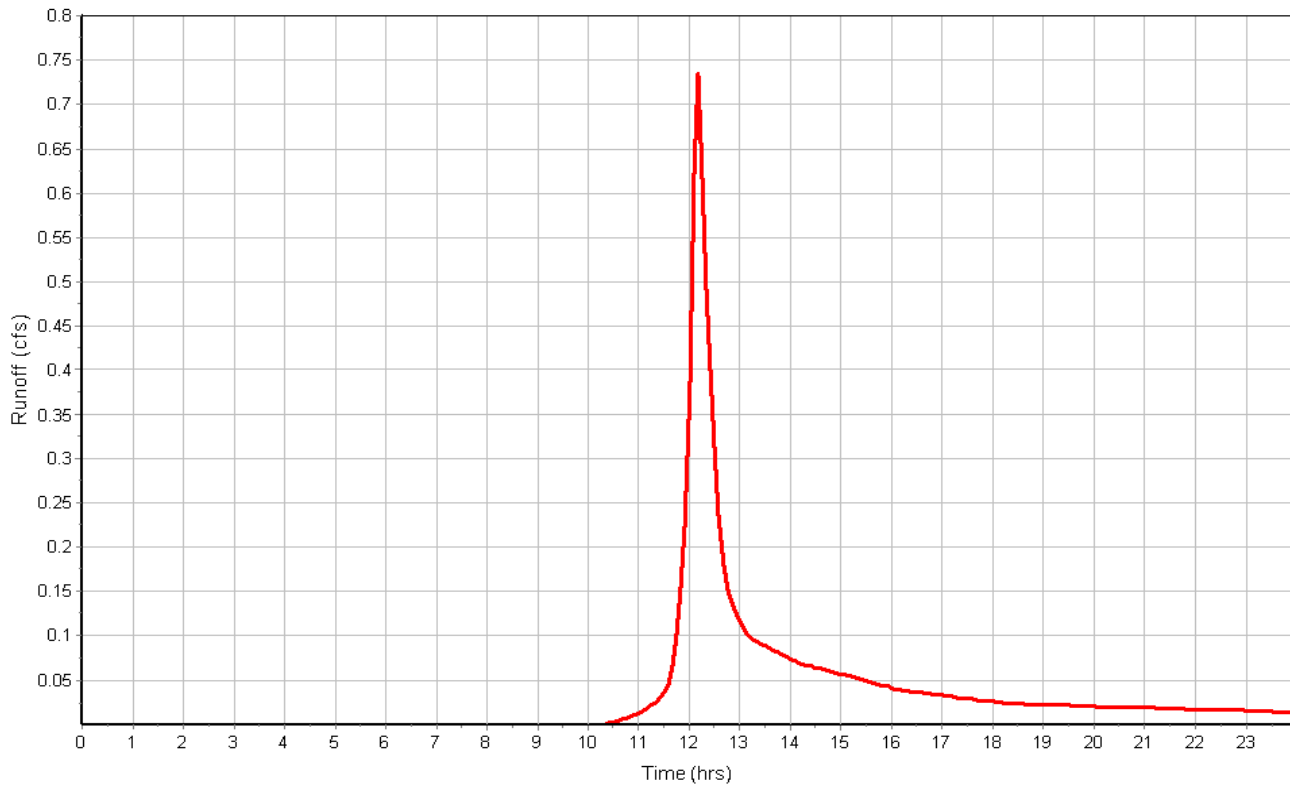

Subbasin : E

Input Data

Area (ac) 3.72
 Weighted Curve Number 77.00
 Rain Gage ID Rain Gage-01

Composite Curve Number

Soil/Surface Description	Area (acres)	Soil Group	Curve Number
Woods, Good	3.72	D	77.00
Composite Area & Weighted CN	3.72		77.00

Time of Concentration

Sheet Flow Computations	Subarea	Subarea	Subarea
	A	B	C
Manning's Roughness :	.6	0.00	0.00
Flow Length (ft) :	100	0.00	0.00
Slope (%) :	14	0.00	0.00
2 yr, 24 hr Rainfall (in) :	3.00	0.00	0.00
Velocity (ft/sec) :	0.12	0.00	0.00
Computed Flow Time (min) :	14.09	0.00	0.00

Shallow Concentrated Flow Computations	Subarea	Subarea	Subarea
	A	B	C
Flow Length (ft) :	375	0.00	0.00
Slope (%) :	20.25	0.00	0.00
Surface Type :	Woodland	Unpaved	Unpaved
Velocity (ft/sec) :	2.25	0.00	0.00
Computed Flow Time (min) :	2.78	0.00	0.00
Total TOC (min)	16.86		

Subbasin Runoff Results

Total Rainfall (in) 3.04
 Total Runoff (in) 1.10
 Peak Runoff (cfs) 3.31
 Weighted Curve Number 77.00
 Time of Concentration (days hh:mm:ss) 0 00:16:52

Subbasin : E

Rainfall Intensity Graph

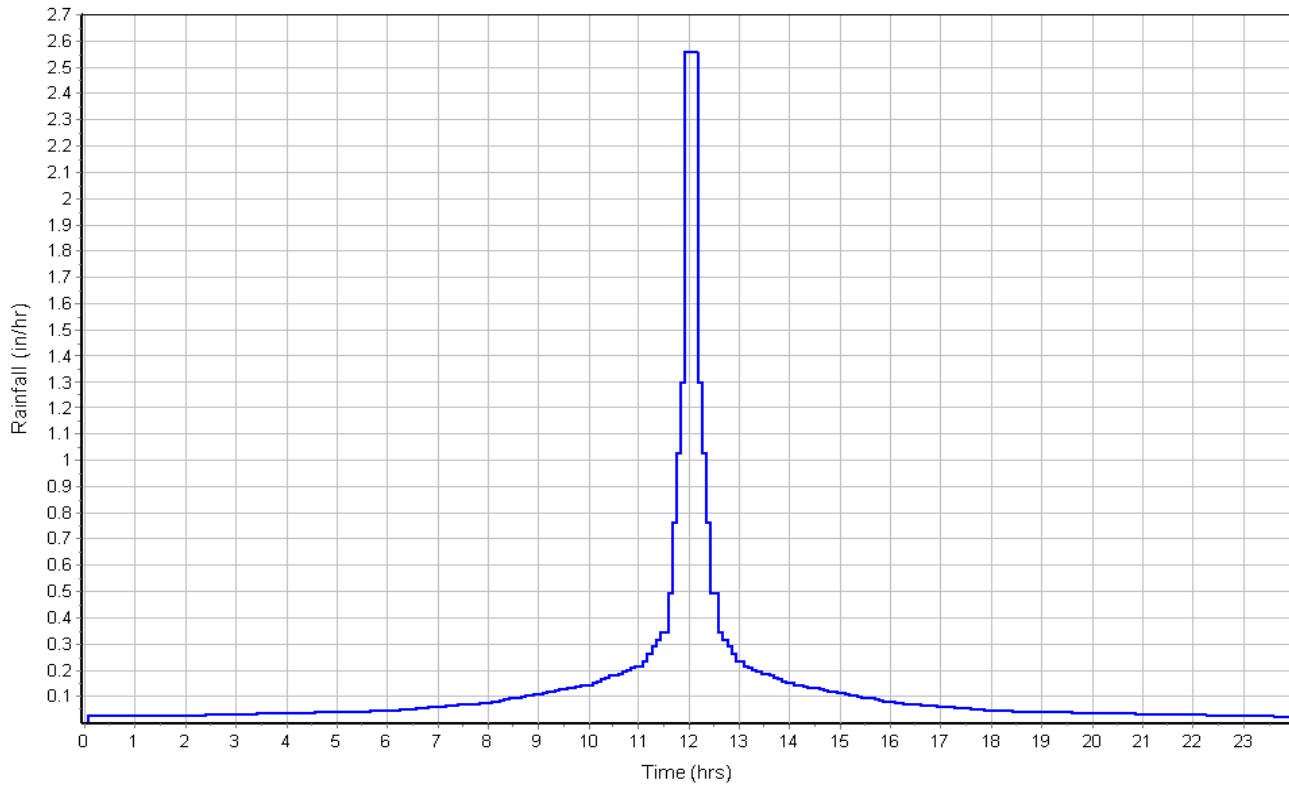

Runoff Hydrograph

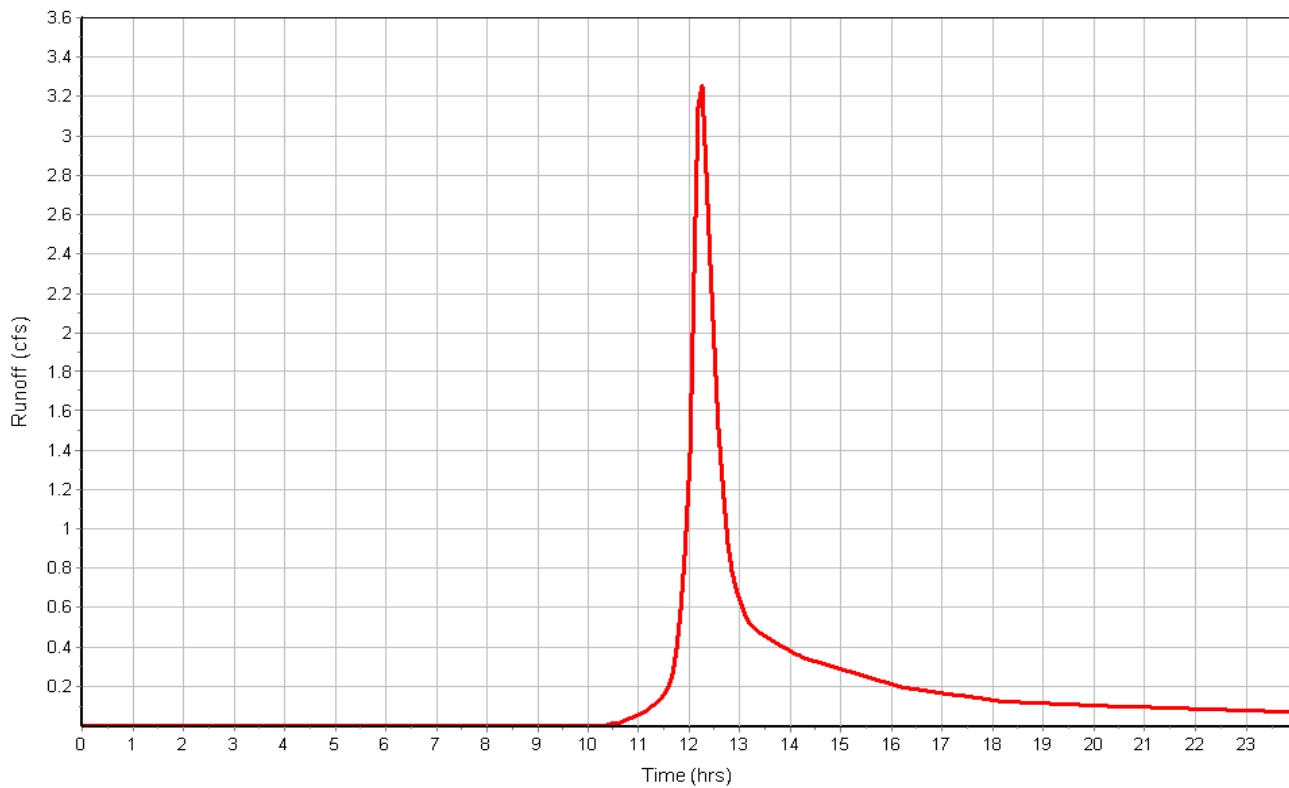

Project Description

File Name Existing Conditions.SPF

Project Options

Flow Units CFS
 Elevation Type Elevation
 Hydrology Method SCS TR-55
 Time of Concentration (TOC) Method SCS TR-55
 Link Routing Method Kinematic Wave
 Enable Overflow Ponding at Nodes YES
 Skip Steady State Analysis Time Periods NO

Analysis Options

Start Analysis On Jul 13, 2017 00:00:00
 End Analysis On Jul 14, 2017 00:00:00
 Start Reporting On Jul 13, 2017 00:00:00
 Antecedent Dry Days 0 days
 Runoff (Dry Weather) Time Step 0 01:00:00 days hh:mm:ss
 Runoff (Wet Weather) Time Step 0 00:05:00 days hh:mm:ss
 Reporting Time Step 0 00:05:00 days hh:mm:ss
 Routing Time Step 30 seconds

Number of Elements

	Qty
Rain Gages	1
Subbasins.....	5
Nodes.....	5
<i>Junctions</i>	0
<i>Outfalls</i>	5
<i>Flow Diversions</i>	0
<i>Inlets</i>	0
<i>Storage Nodes</i>	0
Links.....	0
<i>Channels</i>	0
<i>Pipes</i>	0
<i>Pumps</i>	0
<i>Orifices</i>	0
<i>Weirs</i>	0
<i>Outlets</i>	0
Pollutants	0
Land Uses	0

Rainfall Details

SN	Rain Gage ID	Data Source	Data Source ID	Rainfall Type	Rain Units	State	County	Return Period (years)	Rainfall Depth (inches)	Rainfall Distribution
1	Rain Gage-01	Time Series	TS-10	Cumulative	inches	Maine	Androscoggin	10	4.55	SCS Type III 24-hr

Subbasin Summary

Subbasin ID	Area (ac)	Weighted Curve Number	Total Rainfall (in)	Total Runoff (in)	Total Runoff Volume (ac-in)	Peak Runoff (cfs)	Time of Concentration (days hh:mm:ss)
A	21.12	74.38	4.55	2.04	43.11	26.46	0 00:36:01
B	5.93	75.63	4.55	2.14	12.69	11.09	0 00:14:31
C	22.68	71.14	4.55	1.79	40.67	14.62	0 01:29:22
D	0.74	77.00	4.55	2.25	1.67	1.55	0 00:11:47
E	3.72	77.00	4.55	2.25	8.37	7.00	0 00:16:51

Node Summary

Element ID	Element Type	Invert Elevation
		(ft)
OUT-A	Outfall	298.00
OUT-B	Outfall	310.00
OUT-C	Outfall	298.00
OUT-D	Outfall	338.00
OUT-E	Outfall	298.00

Subbasin Hydrology

Subbasin : A

Input Data

Area (ac) 21.12
Weighted Curve Number 74.38
Rain Gage ID Rain Gage-01

Composite Curve Number

Soil/Surface Description	Area (acres)	Soil Group	Curve Number
Woods, Good	7.92	C	70.00
Woods, Good	13.20	D	77.00
Composite Area & Weighted CN	21.12		74.38

Time of Concentration

TOC Method : SCS TR-55

Sheet Flow Equation :

$$T_c = (0.007 * ((n * L_f)^{0.8})) / ((P^{0.5}) * (S_f^{0.4}))$$

Where :

T_c = Time of Concentration (hr)
n = Manning's roughness
L_f = Flow Length (ft)
P = 2 yr, 24 hr Rainfall (inches)
S_f = Slope (ft/ft)

Shallow Concentrated Flow Equation :

V = 16.1345 * (S_f^{0.5}) (unpaved surface)
V = 20.3282 * (S_f^{0.5}) (paved surface)
V = 15.0 * (S_f^{0.5}) (grassed waterway surface)
V = 10.0 * (S_f^{0.5}) (nearly bare & untilled surface)
V = 9.0 * (S_f^{0.5}) (cultivated straight rows surface)
V = 7.0 * (S_f^{0.5}) (short grass pasture surface)
V = 5.0 * (S_f^{0.5}) (woodland surface)
V = 2.5 * (S_f^{0.5}) (forest w/heavy litter surface)
T_c = (L_f / V) / (3600 sec/hr)

Where:

T_c = Time of Concentration (hr)
L_f = Flow Length (ft)
V = Velocity (ft/sec)
S_f = Slope (ft/ft)

Channel Flow Equation :

V = (1.49 * (R^{2/3}) * (S_f^{0.5})) / n
R = A_q / W_p
T_c = (L_f / V) / (3600 sec/hr)

Where :

T_c = Time of Concentration (hr)
L_f = Flow Length (ft)
R = Hydraulic Radius (ft)
A_q = Flow Area (ft²)
W_p = Wetted Perimeter (ft)
V = Velocity (ft/sec)
S_f = Slope (ft/ft)
n = Manning's roughness

	Subarea	Subarea	Subarea
	A	B	C
Sheet Flow Computations			
Manning's Roughness :	.6	0.00	0.00
Flow Length (ft) :	100	0.00	0.00
Slope (%) :	32.75	0.00	0.00
2 yr, 24 hr Rainfall (in) :	3.00	0.00	0.00
Velocity (ft/sec) :	0.17	0.00	0.00
Computed Flow Time (min) :	10.03	0.00	0.00
	Subarea	Subarea	Subarea
	A	B	C
Shallow Concentrated Flow Computations			
Flow Length (ft) :	870	1086	0.00
Slope (%) :	5.65	.76	0.00
Surface Type :	Woodland		Unpaved
Velocity (ft/sec) :	1.19	1.31	0.00
Computed Flow Time (min) :	12.18	13.82	0.00
Total TOC (min)	36.03		

Subbasin Runoff Results

Total Rainfall (in)	4.55
Total Runoff (in)	2.04
Peak Runoff (cfs)	26.46
Weighted Curve Number	74.38
Time of Concentration (days hh:mm:ss)	0 00:36:02

Subbasin : A

Rainfall Intensity Graph

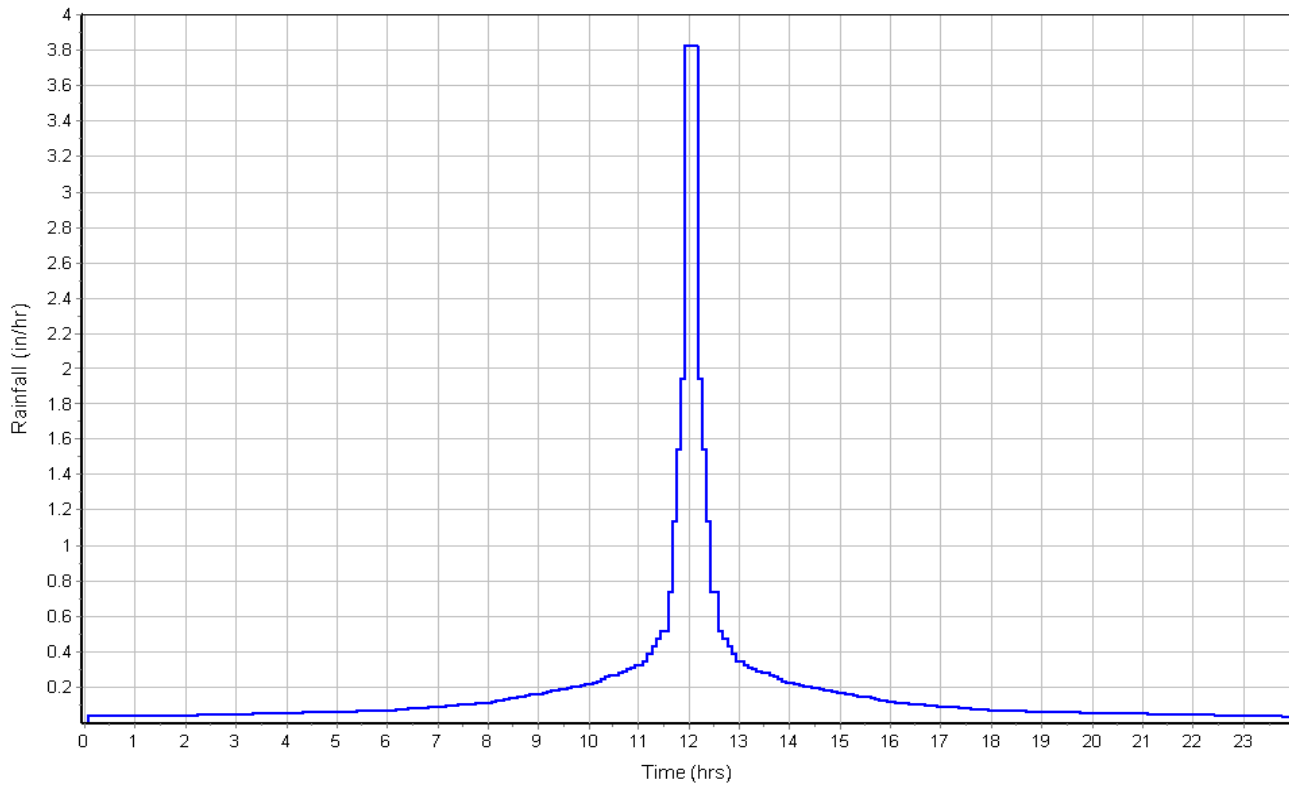

Runoff Hydrograph

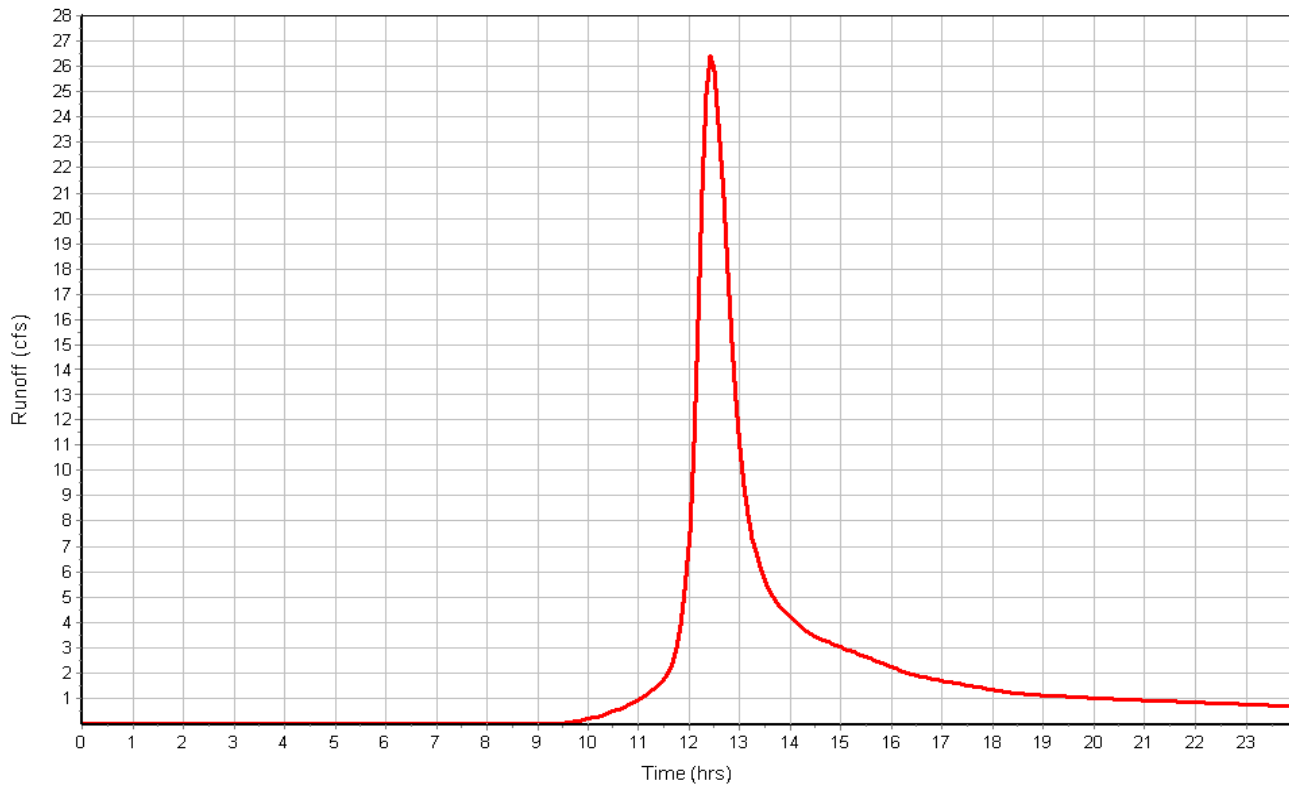

Subbasin : B

Input Data

Area (ac) 5.93
 Weighted Curve Number 75.63
 Rain Gage ID Rain Gage-01

Composite Curve Number

Soil/Surface Description	Area (acres)	Soil Group	Curve Number
Woods, Good	1.16	C	70.00
Woods, Good	4.77	D	77.00
Composite Area & Weighted CN	5.93		75.63

Time of Concentration

	Subarea	Subarea	Subarea
	A	B	C
Sheet Flow Computations			
Manning's Roughness :	.6	0.00	0.00
Flow Length (ft) :	100	0.00	0.00
Slope (%) :	34	0.00	0.00
2 yr, 24 hr Rainfall (in) :	3.00	0.00	0.00
Velocity (ft/sec) :	0.17	0.00	0.00
Computed Flow Time (min) :	9.88	0.00	0.00
Shallow Concentrated Flow Computations			
Flow Length (ft) :	440	0.00	0.00
Slope (%) :	10	0.00	0.00
Surface Type :	Woodland	Unpaved	Unpaved
Velocity (ft/sec) :	1.58	0.00	0.00
Computed Flow Time (min) :	4.64	0.00	0.00
Total TOC (min)	14.52		

Subbasin Runoff Results

Total Rainfall (in) 4.55
 Total Runoff (in) 2.14
 Peak Runoff (cfs) 11.09
 Weighted Curve Number 75.63
 Time of Concentration (days hh:mm:ss) 0 00:14:31

Subbasin : B

Rainfall Intensity Graph

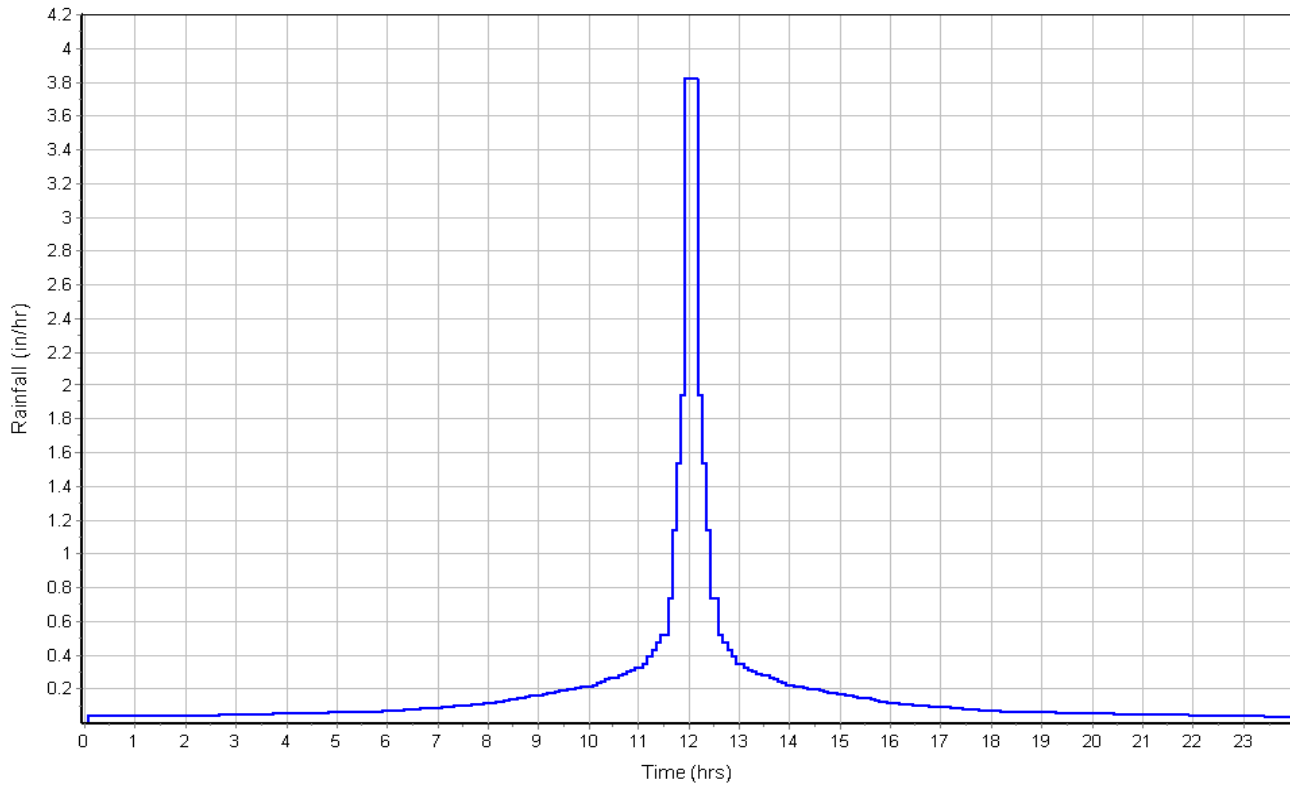

Runoff Hydrograph

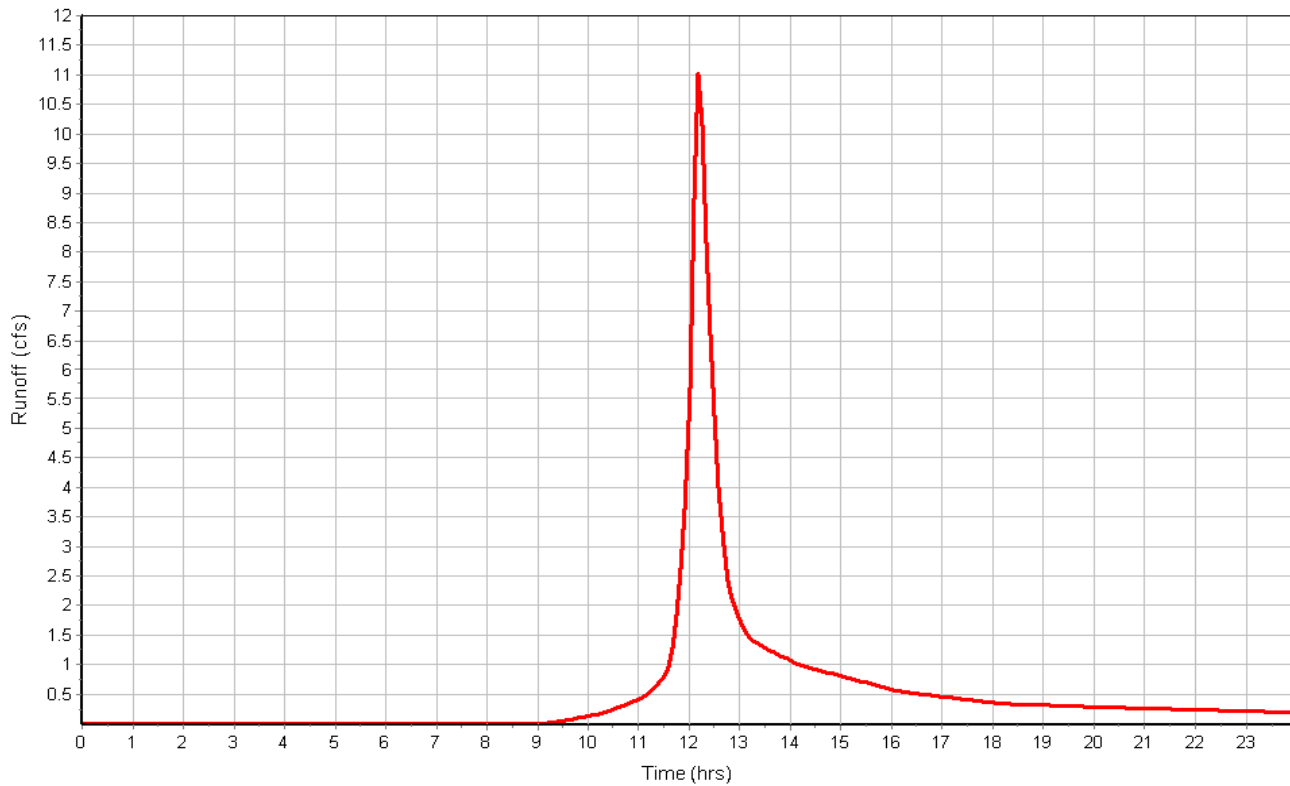

Subbasin : C

Input Data

Area (ac) 22.68
 Weighted Curve Number 71.14
 Rain Gage ID Rain Gage-01

Composite Curve Number

Soil/Surface Description	Area (acres)	Soil Group	Curve Number
Woods, Good	14.42	C	70.00
Woods, Good	7.58	D	77.00
Woods, Good	0.68	A	30.00
Composite Area & Weighted CN	22.68		71.14

Time of Concentration

	Subarea		
	A	B	C
Sheet Flow Computations			
Manning's Roughness :	.6	0.00	0.00
Flow Length (ft) :	100	0.00	0.00
Slope (%) :	.47	0.00	0.00
2 yr, 24 hr Rainfall (in) :	3.00	0.00	0.00
Velocity (ft/sec) :	0.03	0.00	0.00
Computed Flow Time (min) :	54.75	0.00	0.00
Shallow Concentrated Flow Computations			
Flow Length (ft) :	2140	0.00	0.00
Slope (%) :	.47	0.00	0.00
Surface Type :	Grassed waterway	Unpaved	Unpaved
Velocity (ft/sec) :	1.03	0.00	0.00
Computed Flow Time (min) :	34.63	0.00	0.00
Total TOC (min)	89.38		

Subbasin Runoff Results

Total Rainfall (in) 4.55
 Total Runoff (in) 1.79
 Peak Runoff (cfs) 14.62
 Weighted Curve Number 71.14
 Time of Concentration (days hh:mm:ss) 0 01:29:23

Subbasin : C

Rainfall Intensity Graph

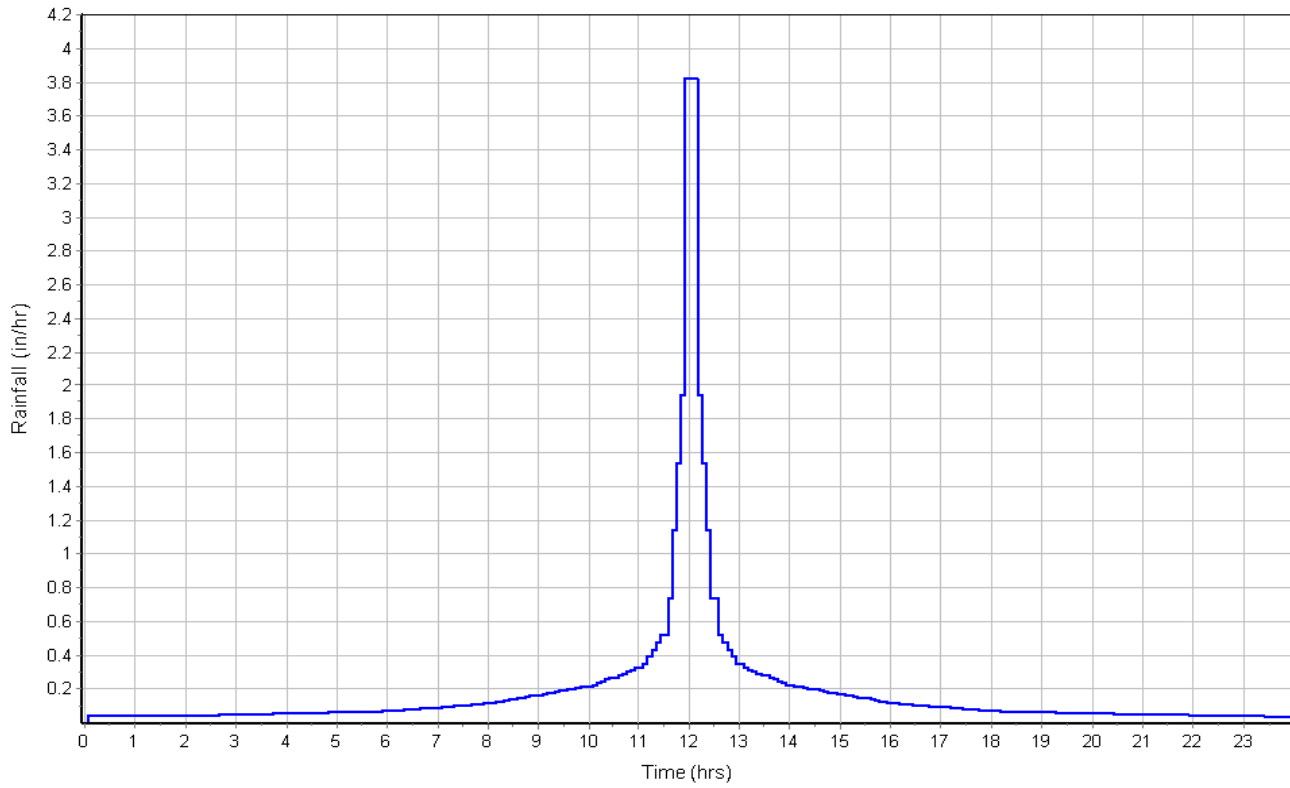

Runoff Hydrograph

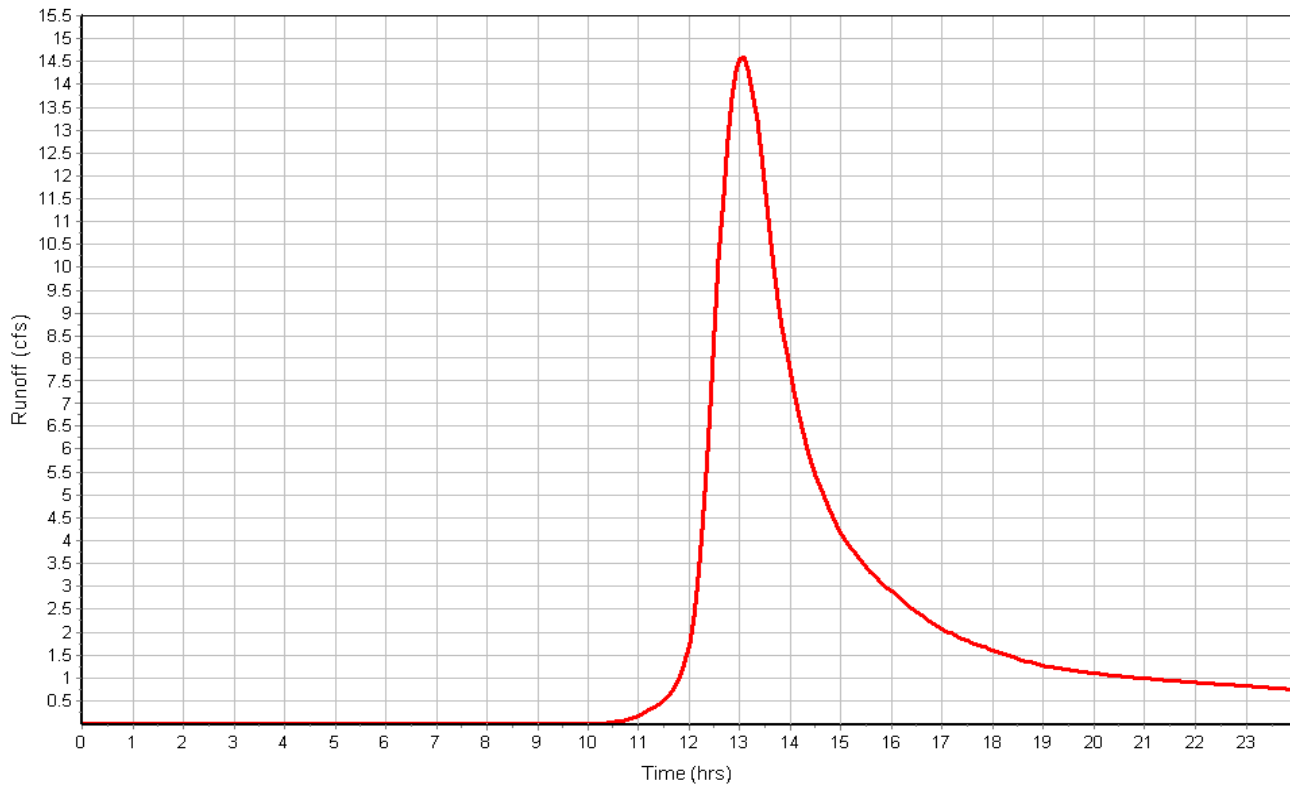

Subbasin : D

Input Data

Area (ac) 0.74
 Weighted Curve Number 77.00
 Rain Gage ID Rain Gage-01

Composite Curve Number

Soil/Surface Description	Area (acres)	Soil Group	Curve Number
Woods, Good	0.74	D	77.00
Composite Area & Weighted CN	0.74		77.00

Time of Concentration

Sheet Flow Computations	Subarea	Subarea	Subarea
	A	B	C
Manning's Roughness :	.6	0.00	0.00
Flow Length (ft) :	100	0.00	0.00
Slope (%) :	23.2	0.00	0.00
2 yr, 24 hr Rainfall (in) :	3.00	0.00	0.00
Velocity (ft/sec) :	0.14	0.00	0.00
Computed Flow Time (min) :	11.51	0.00	0.00

Shallow Concentrated Flow Computations	Subarea	Subarea	Subarea
	A	B	C
Flow Length (ft) :	33	0.00	0.00
Slope (%) :	14.75	0.00	0.00
Surface Type :	Woodland	Unpaved	Unpaved
Velocity (ft/sec) :	1.92	0.00	0.00
Computed Flow Time (min) :	0.29	0.00	0.00
Total TOC (min)	11.79		

Subbasin Runoff Results

Total Rainfall (in) 4.55
 Total Runoff (in) 2.25
 Peak Runoff (cfs) 1.55
 Weighted Curve Number 77.00
 Time of Concentration (days hh:mm:ss) 0 00:11:47

Subbasin : D

Rainfall Intensity Graph

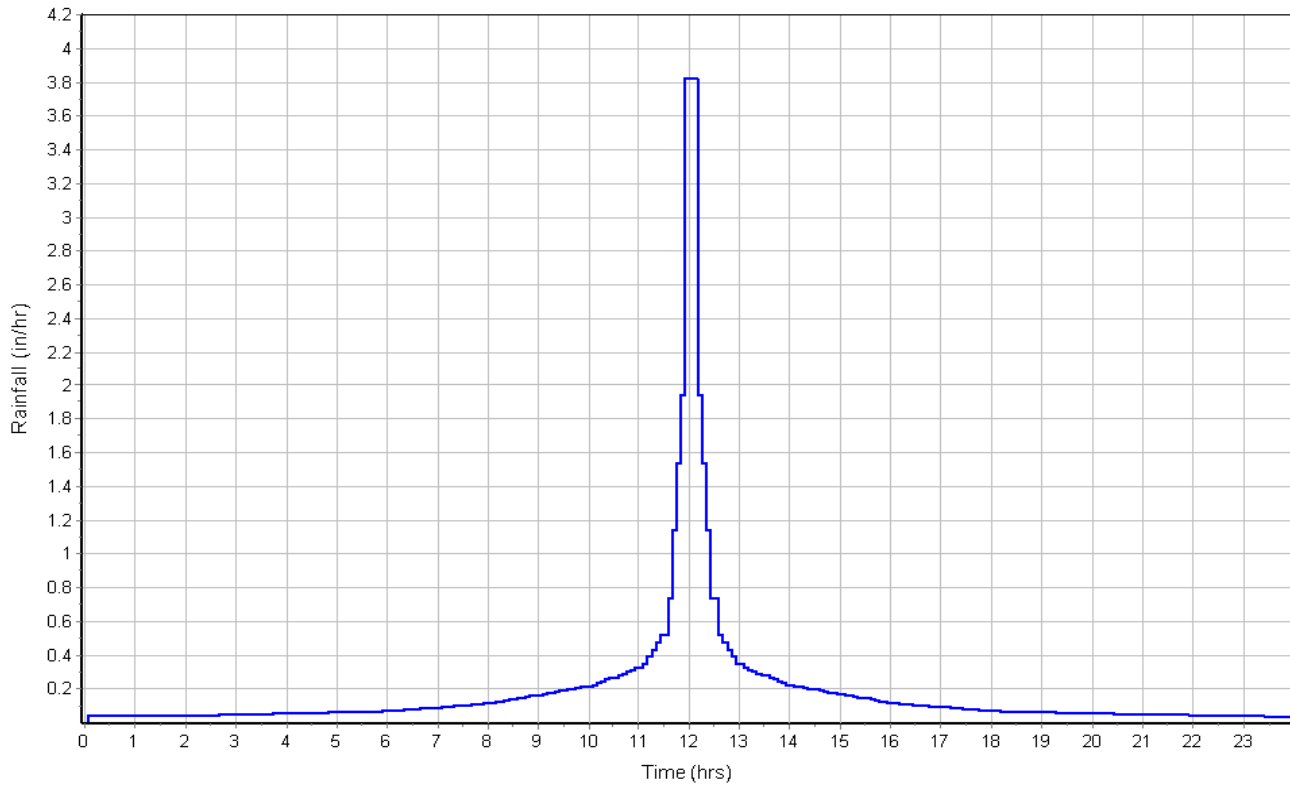

Runoff Hydrograph

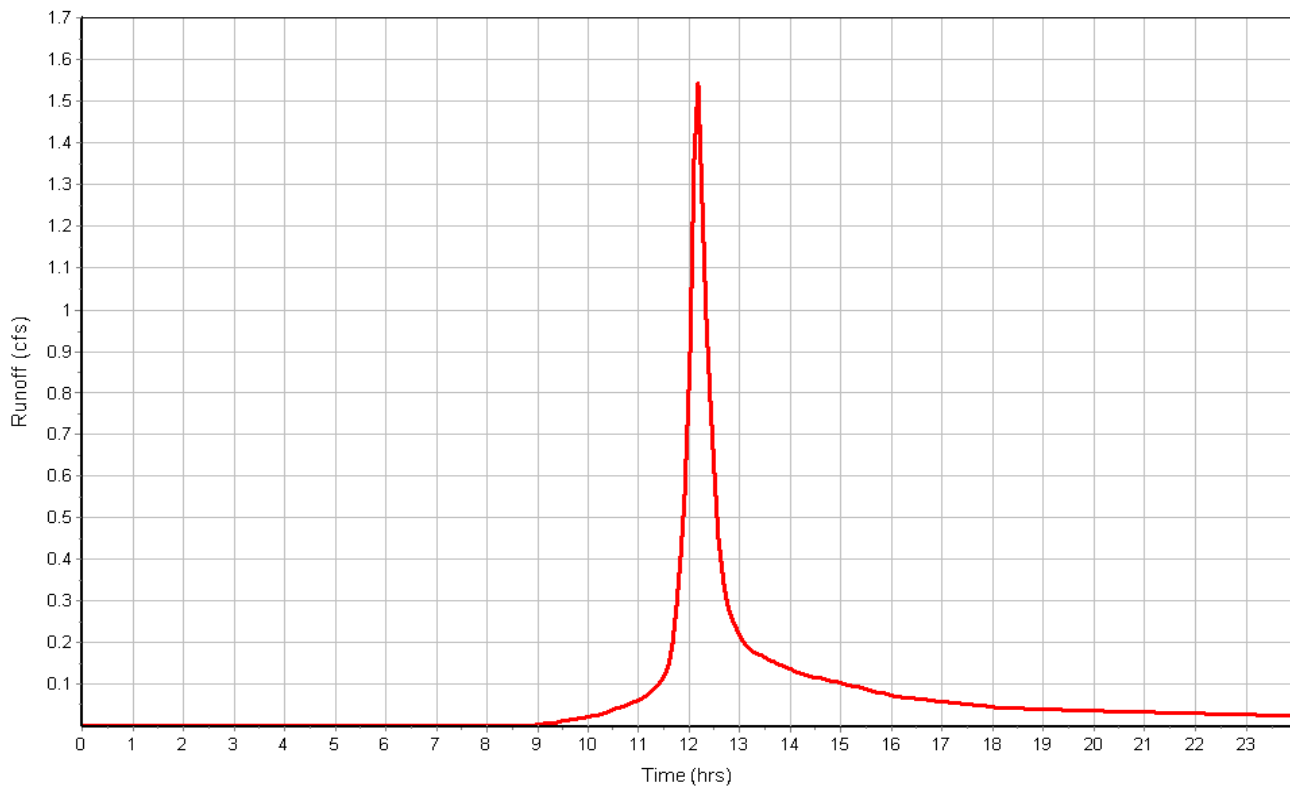

Subbasin : E

Input Data

Area (ac) 3.72
 Weighted Curve Number 77.00
 Rain Gage ID Rain Gage-01

Composite Curve Number

Soil/Surface Description	Area (acres)	Soil Group	Curve Number
Woods, Good	3.72	D	77.00
Composite Area & Weighted CN	3.72		77.00

Time of Concentration

Sheet Flow Computations	Subarea	Subarea	Subarea
	A	B	C
Manning's Roughness :	.6	0.00	0.00
Flow Length (ft) :	100	0.00	0.00
Slope (%) :	14	0.00	0.00
2 yr, 24 hr Rainfall (in) :	3.00	0.00	0.00
Velocity (ft/sec) :	0.12	0.00	0.00
Computed Flow Time (min) :	14.09	0.00	0.00

Shallow Concentrated Flow Computations	Subarea	Subarea	Subarea
	A	B	C
Flow Length (ft) :	375	0.00	0.00
Slope (%) :	20.25	0.00	0.00
Surface Type :	Woodland	Unpaved	Unpaved
Velocity (ft/sec) :	2.25	0.00	0.00
Computed Flow Time (min) :	2.78	0.00	0.00
Total TOC (min)16.86			

Subbasin Runoff Results

Total Rainfall (in) 4.55
 Total Runoff (in) 2.25
 Peak Runoff (cfs) 7.00
 Weighted Curve Number 77.00
 Time of Concentration (days hh:mm:ss) 0 00:16:52

Subbasin : E

Rainfall Intensity Graph

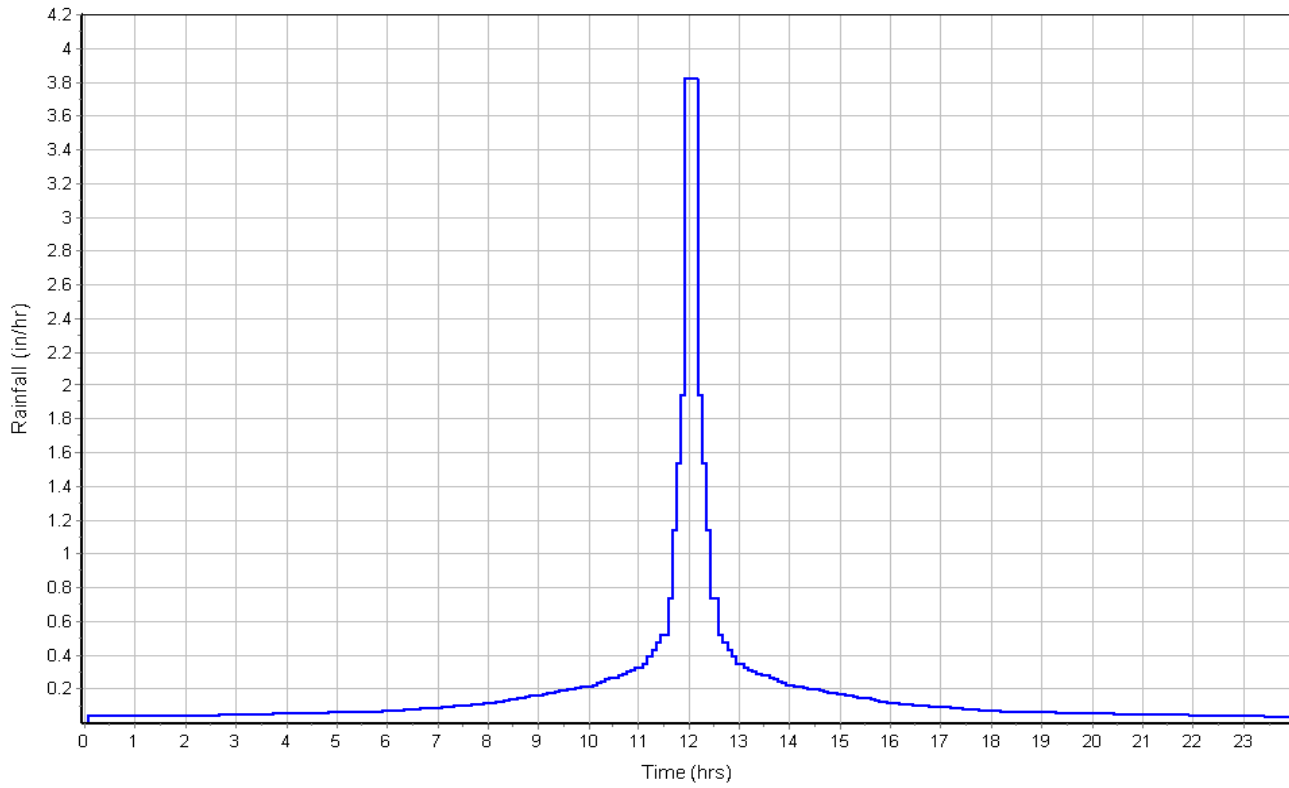

Runoff Hydrograph

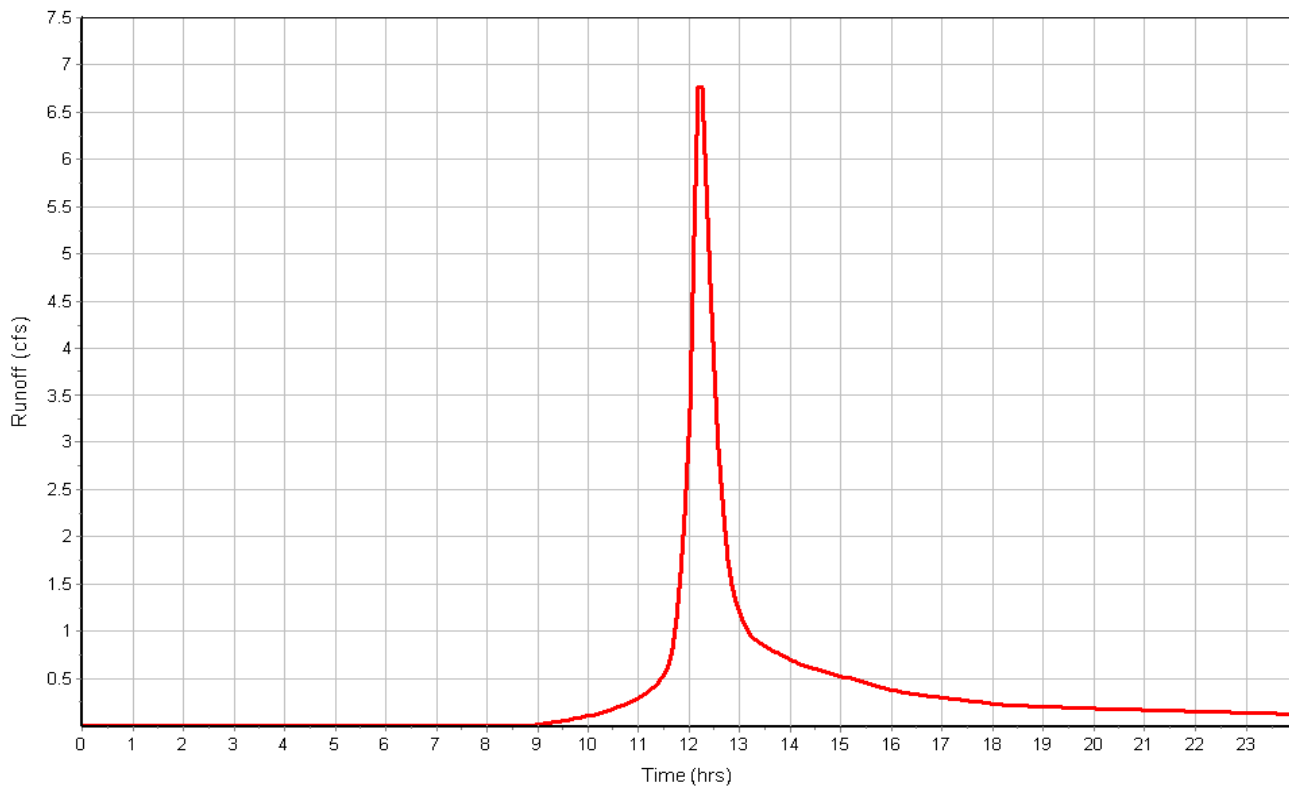

Project Description

File Name Existing Conditions.SPF

Project Options

Flow Units CFS
 Elevation Type Elevation
 Hydrology Method SCS TR-55
 Time of Concentration (TOC) Method SCS TR-55
 Link Routing Method Kinematic Wave
 Enable Overflow Ponding at Nodes YES
 Skip Steady State Analysis Time Periods NO

Analysis Options

Start Analysis On Jul 13, 2017 00:00:00
 End Analysis On Jul 14, 2017 00:00:00
 Start Reporting On Jul 13, 2017 00:00:00
 Antecedent Dry Days 0 days
 Runoff (Dry Weather) Time Step 0 01:00:00 days hh:mm:ss
 Runoff (Wet Weather) Time Step 0 00:05:00 days hh:mm:ss
 Reporting Time Step 0 00:05:00 days hh:mm:ss
 Routing Time Step 30 seconds

Number of Elements

	Qty
Rain Gages	1
Subbasins.....	5
Nodes.....	5
<i>Junctions</i>	0
<i>Outfalls</i>	5
<i>Flow Diversions</i>	0
<i>Inlets</i>	0
<i>Storage Nodes</i>	0
Links.....	0
<i>Channels</i>	0
<i>Pipes</i>	0
<i>Pumps</i>	0
<i>Orifices</i>	0
<i>Weirs</i>	0
<i>Outlets</i>	0
Pollutants	0
Land Uses	0

Rainfall Details

SN	Rain Gage ID	Data Source	Data Source ID	Rainfall Type	Rain Units	State	County	Return Period (years)	Rainfall Depth (inches)	Rainfall Distribution
1	Rain Gage-01	Time Series	TS-25	Cumulative	inches	Maine	Androscoggin	25	5.49	SCS Type III 24-hr

Subbasin Summary

Subbasin ID	Area (ac)	Weighted Curve Number	Total Rainfall (in)	Total Runoff (in)	Total Runoff Volume (ac-in)	Peak Runoff (cfs)	Time of Concentration (days hh:mm:ss)
A	21.12	74.38	5.49	2.80	59.03	36.58	0 00:36:01
B	5.93	75.63	5.49	2.91	17.26	15.17	0 00:14:31
C	22.68	71.14	5.49	2.51	56.84	20.83	0 01:29:22
D	0.74	77.00	5.49	3.04	2.25	2.09	0 00:11:47
E	3.72	77.00	5.49	3.04	11.30	9.47	0 00:16:51

Node Summary

Element ID	Element Type	Invert Elevation
		(ft)
OUT-A	Outfall	298.00
OUT-B	Outfall	310.00
OUT-C	Outfall	298.00
OUT-D	Outfall	338.00
OUT-E	Outfall	298.00

Subbasin Hydrology

Subbasin : A

Input Data

Area (ac) 21.12
 Weighted Curve Number 74.38
 Rain Gage ID Rain Gage-01

Composite Curve Number

Soil/Surface Description	Area (acres)	Soil Group	Curve Number
Woods, Good	7.92	C	70.00
Woods, Good	13.20	D	77.00
Composite Area & Weighted CN	21.12		74.38

Time of Concentration

TOC Method : SCS TR-55

Sheet Flow Equation :

$$T_c = (0.007 * ((n * L_f)^{0.8})) / ((P^{0.5}) * (S_f^{0.4}))$$

Where :

T_c = Time of Concentration (hr)
 n = Manning's roughness
 L_f = Flow Length (ft)
 P = 2 yr, 24 hr Rainfall (inches)
 S_f = Slope (ft/ft)

Shallow Concentrated Flow Equation :

V = 16.1345 * (S_f^{0.5}) (unpaved surface)
 V = 20.3282 * (S_f^{0.5}) (paved surface)
 V = 15.0 * (S_f^{0.5}) (grassed waterway surface)
 V = 10.0 * (S_f^{0.5}) (nearly bare & untilled surface)
 V = 9.0 * (S_f^{0.5}) (cultivated straight rows surface)
 V = 7.0 * (S_f^{0.5}) (short grass pasture surface)
 V = 5.0 * (S_f^{0.5}) (woodland surface)
 V = 2.5 * (S_f^{0.5}) (forest w/heavy litter surface)
 T_c = (L_f / V) / (3600 sec/hr)

Where:

T_c = Time of Concentration (hr)
 L_f = Flow Length (ft)
 V = Velocity (ft/sec)
 S_f = Slope (ft/ft)

Channel Flow Equation :

V = (1.49 * (R^{2/3}) * (S_f^{0.5})) / n
 R = A_q / W_p
 T_c = (L_f / V) / (3600 sec/hr)

Where :

T_c = Time of Concentration (hr)
 L_f = Flow Length (ft)
 R = Hydraulic Radius (ft)
 A_q = Flow Area (ft²)
 W_p = Wetted Perimeter (ft)
 V = Velocity (ft/sec)
 S_f = Slope (ft/ft)
 n = Manning's roughness

	Subarea	Subarea	Subarea
	A	B	C
Sheet Flow Computations			
Manning's Roughness :	.6	0.00	0.00
Flow Length (ft) :	100	0.00	0.00
Slope (%) :	32.75	0.00	0.00
2 yr, 24 hr Rainfall (in) :	3.00	0.00	0.00
Velocity (ft/sec) :	0.17	0.00	0.00
Computed Flow Time (min) :	10.03	0.00	0.00
	Subarea	Subarea	Subarea
	A	B	C
Shallow Concentrated Flow Computations			
Flow Length (ft) :	870	1086	0.00
Slope (%) :	5.65	.76	0.00
Surface Type :	Woodland		Unpaved
Velocity (ft/sec) :	1.19	1.31	0.00
Computed Flow Time (min) :	12.18	13.82	0.00
Total TOC (min)	36.03		

Subbasin Runoff Results

Total Rainfall (in)	5.49
Total Runoff (in)	2.80
Peak Runoff (cfs)	36.58
Weighted Curve Number	74.38
Time of Concentration (days hh:mm:ss)	0 00:36:02

Subbasin : A

Rainfall Intensity Graph

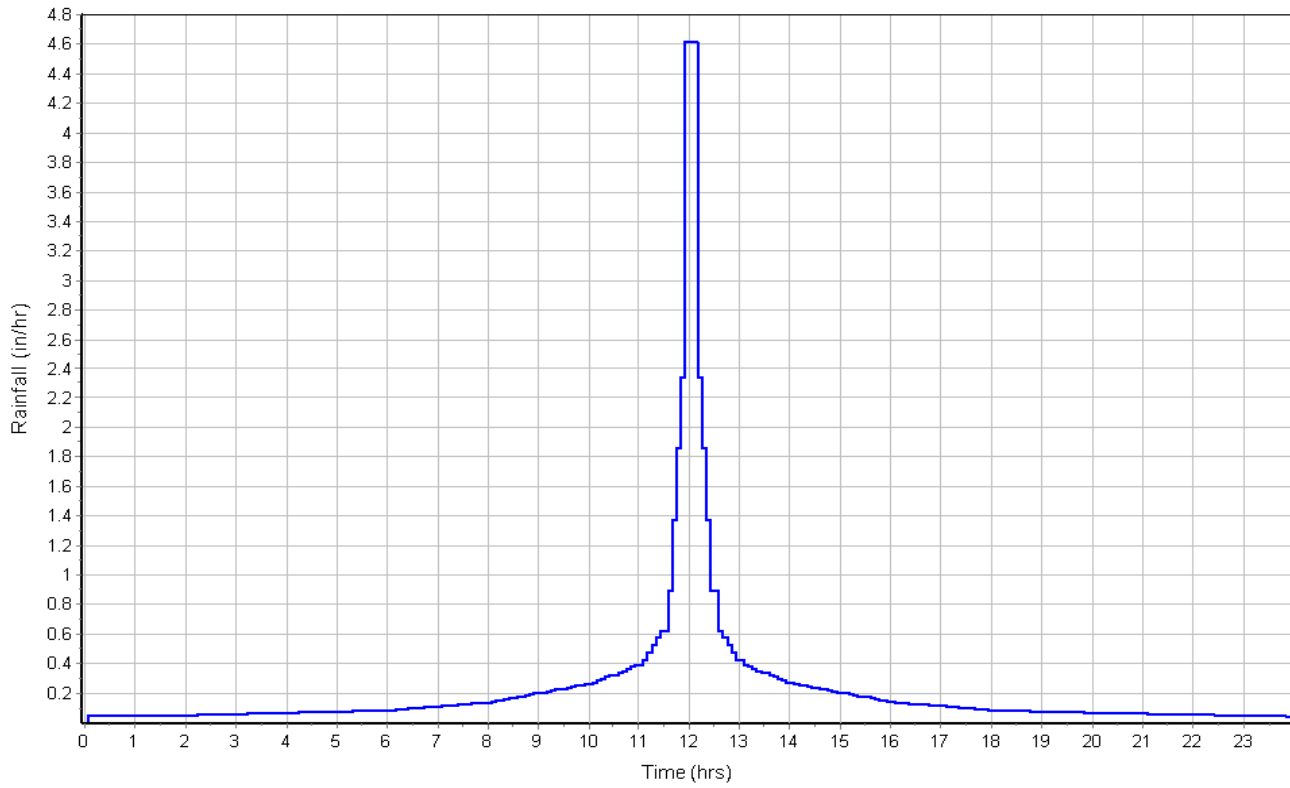

Runoff Hydrograph

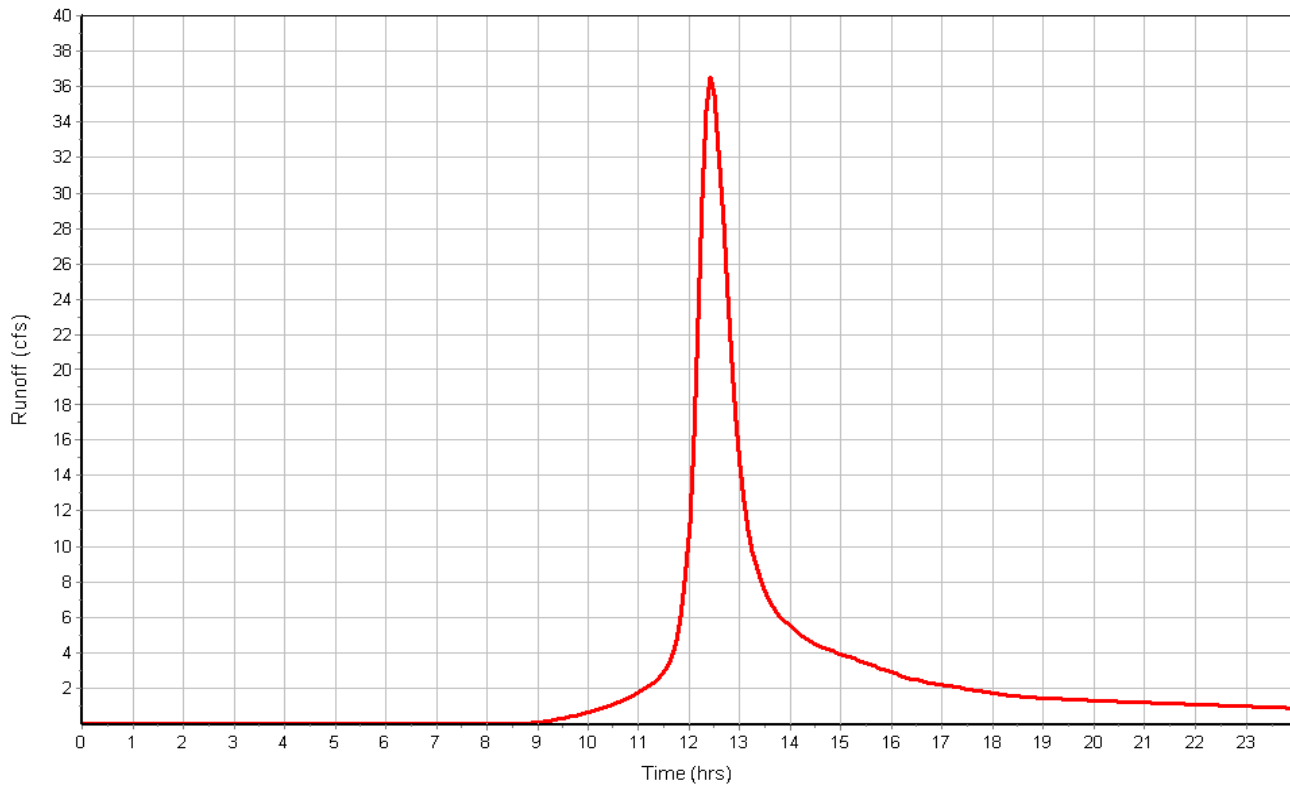

Subbasin : B

Input Data

Area (ac) 5.93
 Weighted Curve Number 75.63
 Rain Gage ID Rain Gage-01

Composite Curve Number

Soil/Surface Description	Area (acres)	Soil Group	Curve Number
Woods, Good	1.16	C	70.00
Woods, Good	4.77	D	77.00
Composite Area & Weighted CN	5.93		75.63

Time of Concentration

	Subarea	Subarea	Subarea
	A	B	C
Sheet Flow Computations			
Manning's Roughness :	.6	0.00	0.00
Flow Length (ft) :	100	0.00	0.00
Slope (%) :	34	0.00	0.00
2 yr, 24 hr Rainfall (in) :	3.00	0.00	0.00
Velocity (ft/sec) :	0.17	0.00	0.00
Computed Flow Time (min) :	9.88	0.00	0.00
Shallow Concentrated Flow Computations			
Flow Length (ft) :	440	0.00	0.00
Slope (%) :	10	0.00	0.00
Surface Type :	Woodland	Unpaved	Unpaved
Velocity (ft/sec) :	1.58	0.00	0.00
Computed Flow Time (min) :	4.64	0.00	0.00
Total TOC (min)	14.52		

Subbasin Runoff Results

Total Rainfall (in) 5.49
 Total Runoff (in) 2.91
 Peak Runoff (cfs) 15.17
 Weighted Curve Number 75.63
 Time of Concentration (days hh:mm:ss) 0 00:14:31

Subbasin : B

Rainfall Intensity Graph

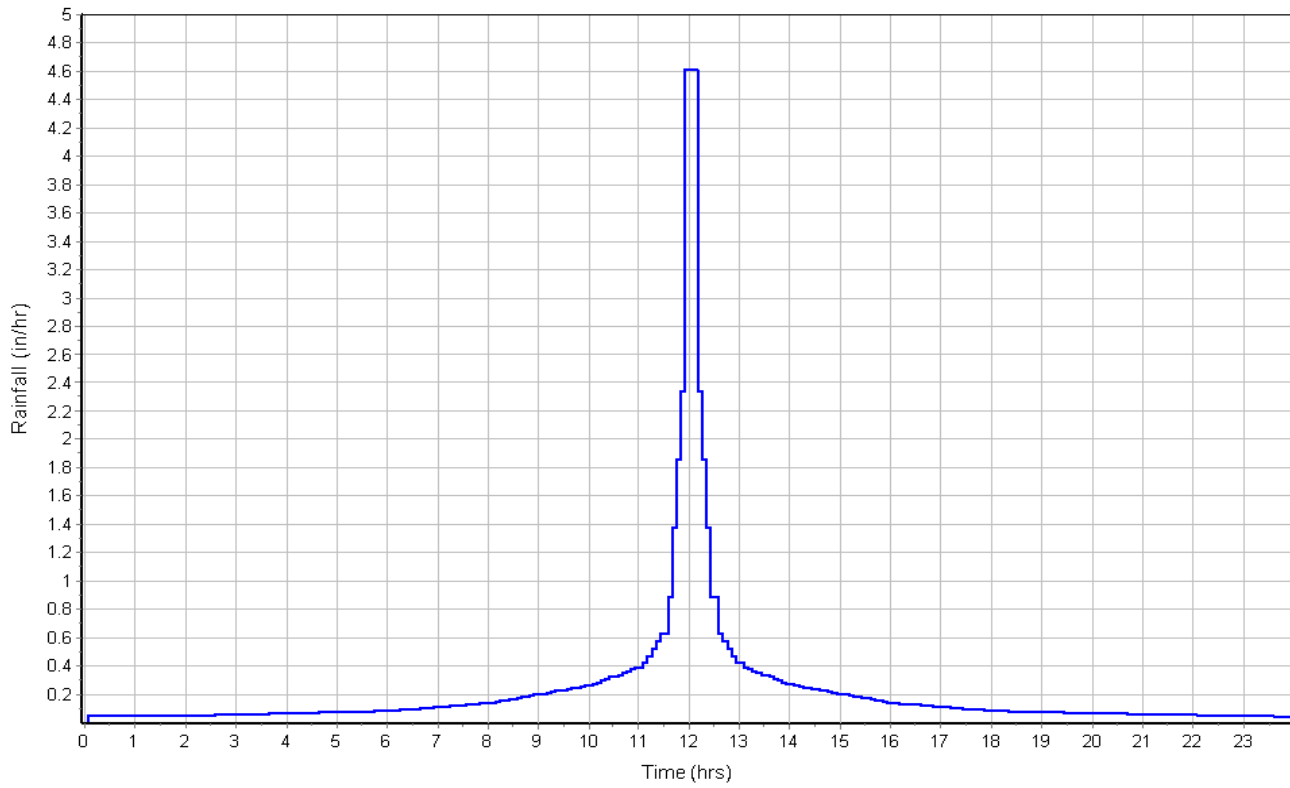

Runoff Hydrograph

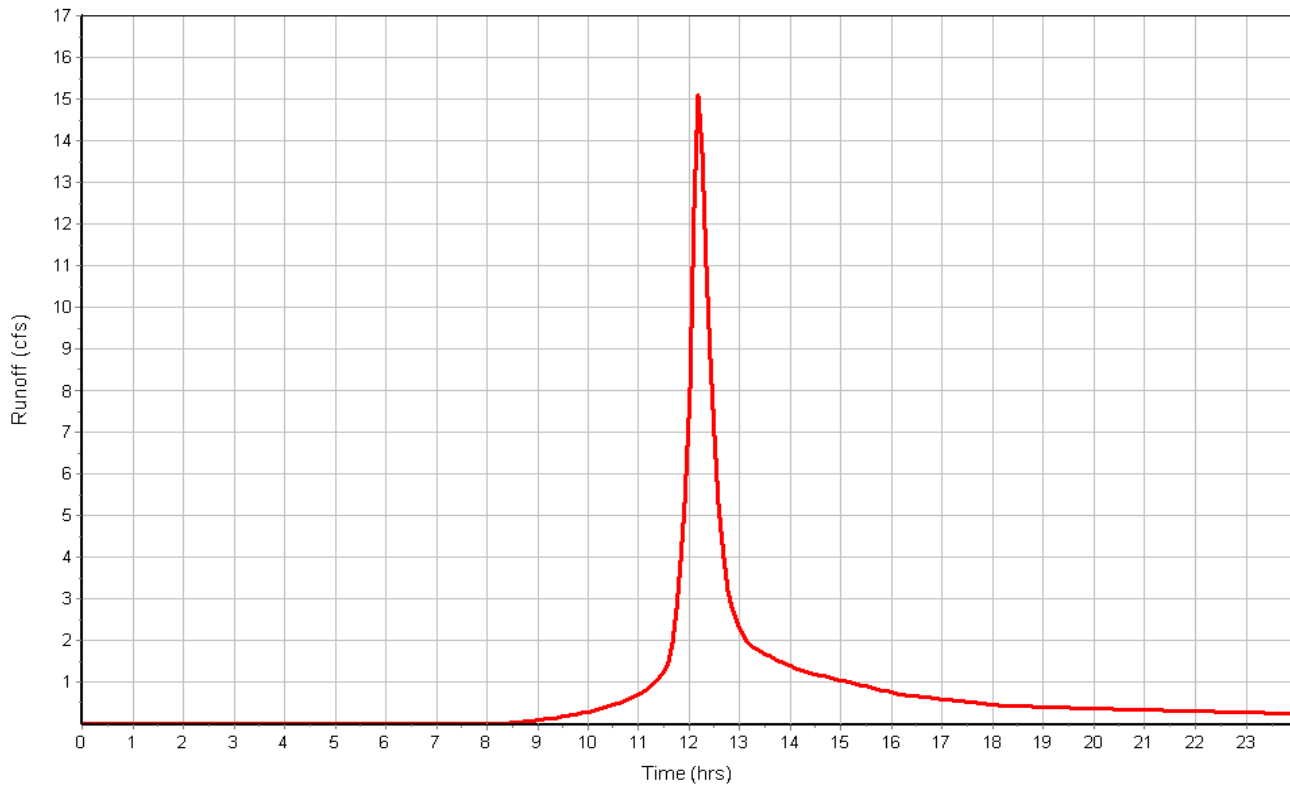

Subbasin : C

Input Data

Area (ac) 22.68
 Weighted Curve Number 71.14
 Rain Gage ID Rain Gage-01

Composite Curve Number

Soil/Surface Description	Area (acres)	Soil Group	Curve Number
Woods, Good	14.42	C	70.00
Woods, Good	7.58	D	77.00
Woods, Good	0.68	A	30.00
Composite Area & Weighted CN	22.68		71.14

Time of Concentration

	Subarea		
	A	B	C
Sheet Flow Computations			
Manning's Roughness :	.6	0.00	0.00
Flow Length (ft) :	100	0.00	0.00
Slope (%) :	.47	0.00	0.00
2 yr, 24 hr Rainfall (in) :	3.00	0.00	0.00
Velocity (ft/sec) :	0.03	0.00	0.00
Computed Flow Time (min) :	54.75	0.00	0.00
Shallow Concentrated Flow Computations			
Flow Length (ft) :	2140	0.00	0.00
Slope (%) :	.47	0.00	0.00
Surface Type :	Grassed waterway	Unpaved	Unpaved
Velocity (ft/sec) :	1.03	0.00	0.00
Computed Flow Time (min) :	34.63	0.00	0.00
Total TOC (min)	89.38		

Subbasin Runoff Results

Total Rainfall (in) 5.49
 Total Runoff (in) 2.51
 Peak Runoff (cfs) 20.83
 Weighted Curve Number 71.14
 Time of Concentration (days hh:mm:ss) 0 01:29:23

Subbasin : C

Rainfall Intensity Graph

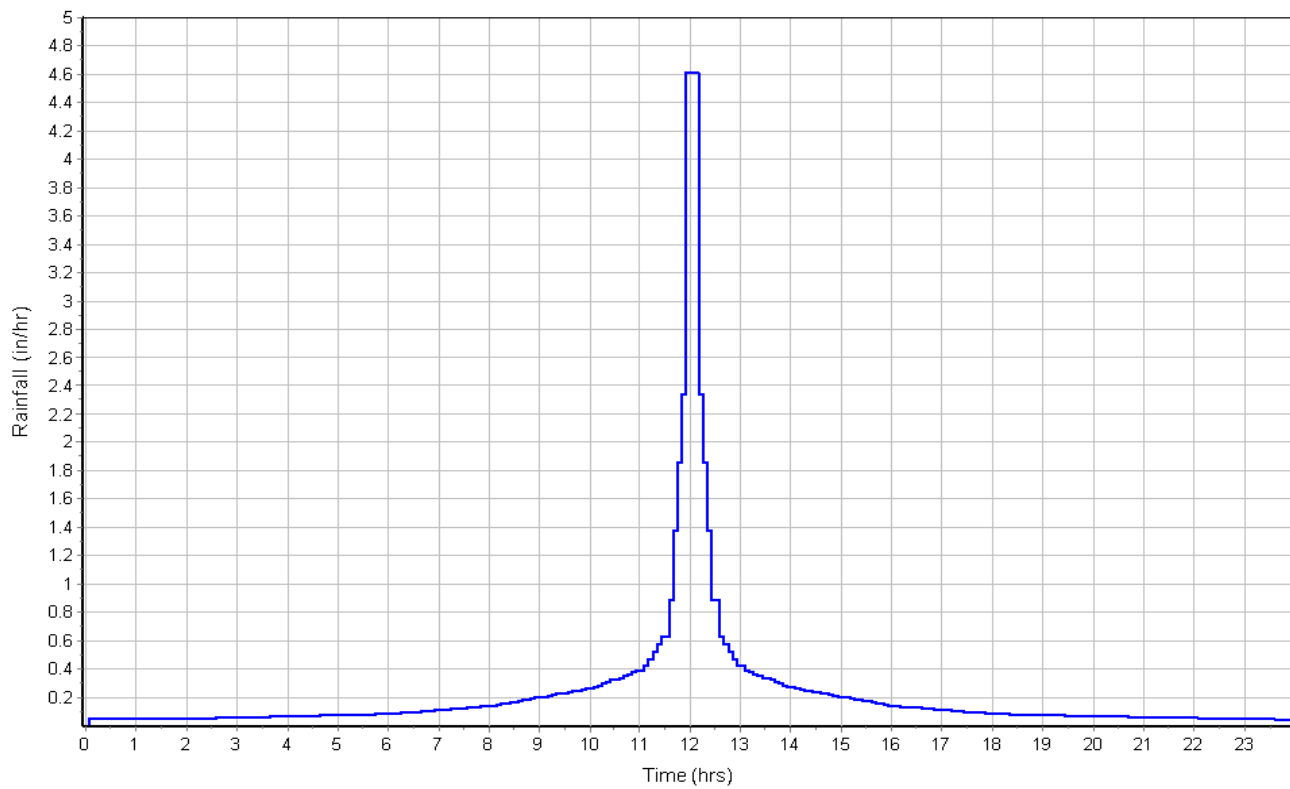

Runoff Hydrograph

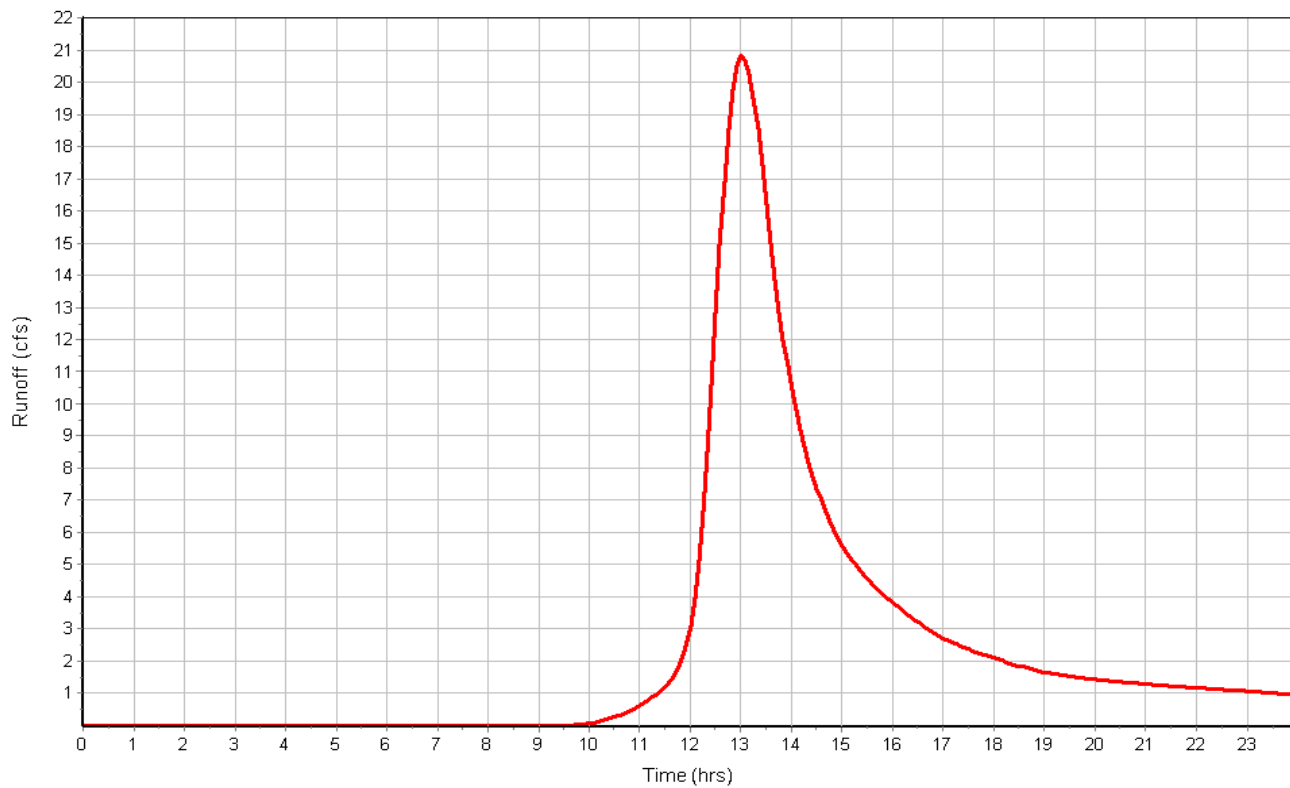

Subbasin : D

Input Data

Area (ac) 0.74
 Weighted Curve Number 77.00
 Rain Gage ID Rain Gage-01

Composite Curve Number

Soil/Surface Description	Area (acres)	Soil Group	Curve Number
Woods, Good	0.74	D	77.00
Composite Area & Weighted CN	0.74		77.00

Time of Concentration

Sheet Flow Computations	Subarea	Subarea	Subarea
	A	B	C
Manning's Roughness :	.6	0.00	0.00
Flow Length (ft) :	100	0.00	0.00
Slope (%) :	23.2	0.00	0.00
2 yr, 24 hr Rainfall (in) :	3.00	0.00	0.00
Velocity (ft/sec) :	0.14	0.00	0.00
Computed Flow Time (min) :	11.51	0.00	0.00

Shallow Concentrated Flow Computations	Subarea	Subarea	Subarea
	A	B	C
Flow Length (ft) :	33	0.00	0.00
Slope (%) :	14.75	0.00	0.00
Surface Type :	Woodland	Unpaved	Unpaved
Velocity (ft/sec) :	1.92	0.00	0.00
Computed Flow Time (min) :	0.29	0.00	0.00
Total TOC (min)	11.79		

Subbasin Runoff Results

Total Rainfall (in) 5.49
 Total Runoff (in) 3.04
 Peak Runoff (cfs) 2.09
 Weighted Curve Number 77.00
 Time of Concentration (days hh:mm:ss) 0 00:11:47

Subbasin : D

Rainfall Intensity Graph

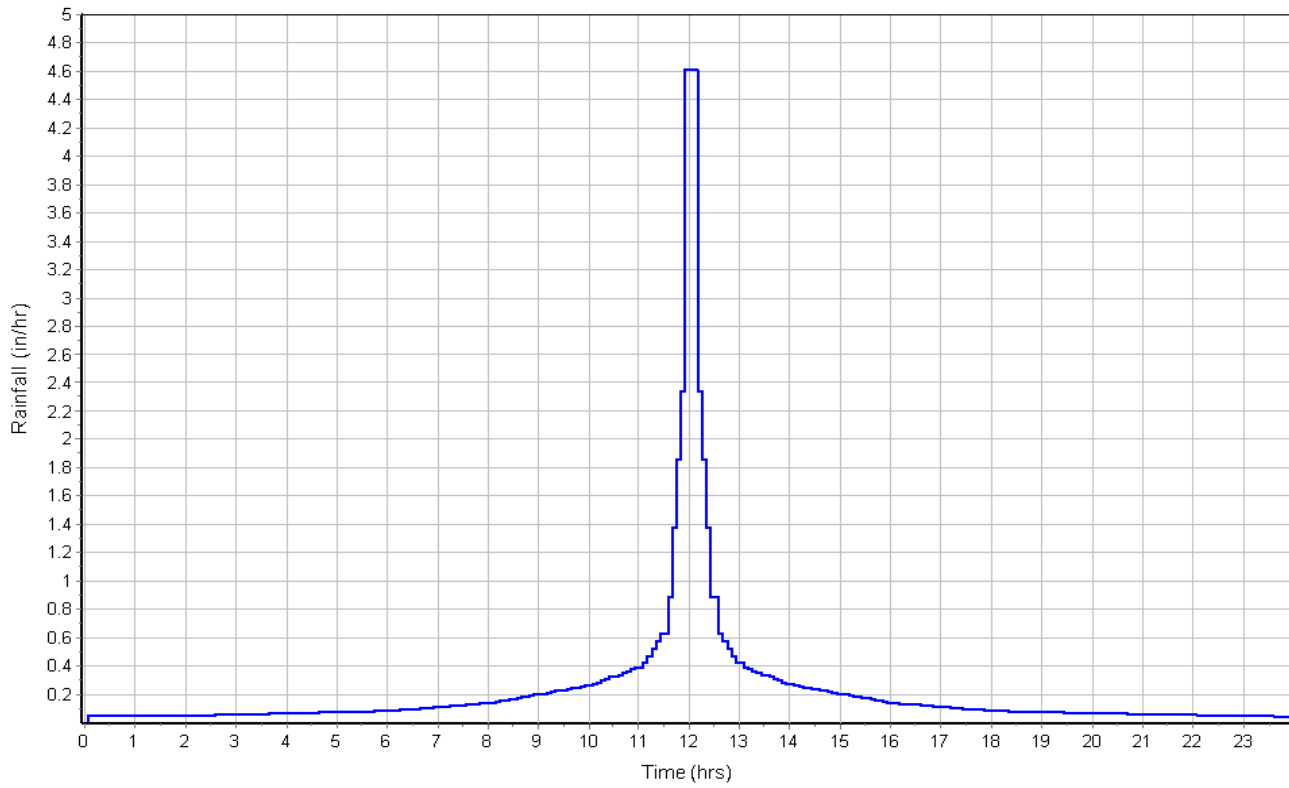

Runoff Hydrograph

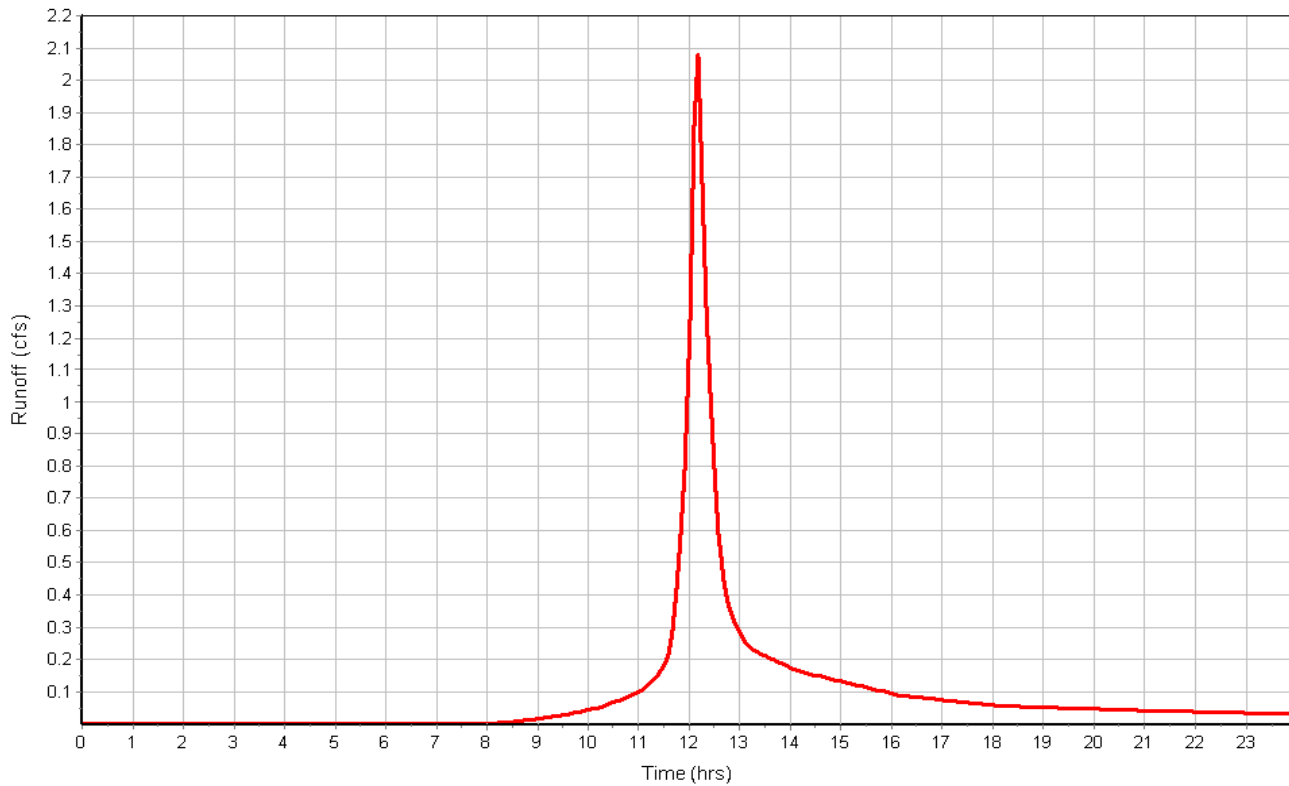

Subbasin : E

Input Data

Area (ac) 3.72
 Weighted Curve Number 77.00
 Rain Gage ID Rain Gage-01

Composite Curve Number

Soil/Surface Description	Area (acres)	Soil Group	Curve Number
Woods, Good	3.72	D	77.00
Composite Area & Weighted CN	3.72		77.00

Time of Concentration

Sheet Flow Computations	Subarea	Subarea	Subarea
	A	B	C
Manning's Roughness :	.6	0.00	0.00
Flow Length (ft) :	100	0.00	0.00
Slope (%) :	14	0.00	0.00
2 yr, 24 hr Rainfall (in) :	3.00	0.00	0.00
Velocity (ft/sec) :	0.12	0.00	0.00
Computed Flow Time (min) :	14.09	0.00	0.00

Shallow Concentrated Flow Computations	Subarea	Subarea	Subarea
	A	B	C
Flow Length (ft) :	375	0.00	0.00
Slope (%) :	20.25	0.00	0.00
Surface Type :	Woodland	Unpaved	Unpaved
Velocity (ft/sec) :	2.25	0.00	0.00
Computed Flow Time (min) :	2.78	0.00	0.00
Total TOC (min)	16.86		

Subbasin Runoff Results

Total Rainfall (in) 5.49
 Total Runoff (in) 3.04
 Peak Runoff (cfs) 9.47
 Weighted Curve Number 77.00
 Time of Concentration (days hh:mm:ss) 0 00:16:52

Subbasin : E

Rainfall Intensity Graph

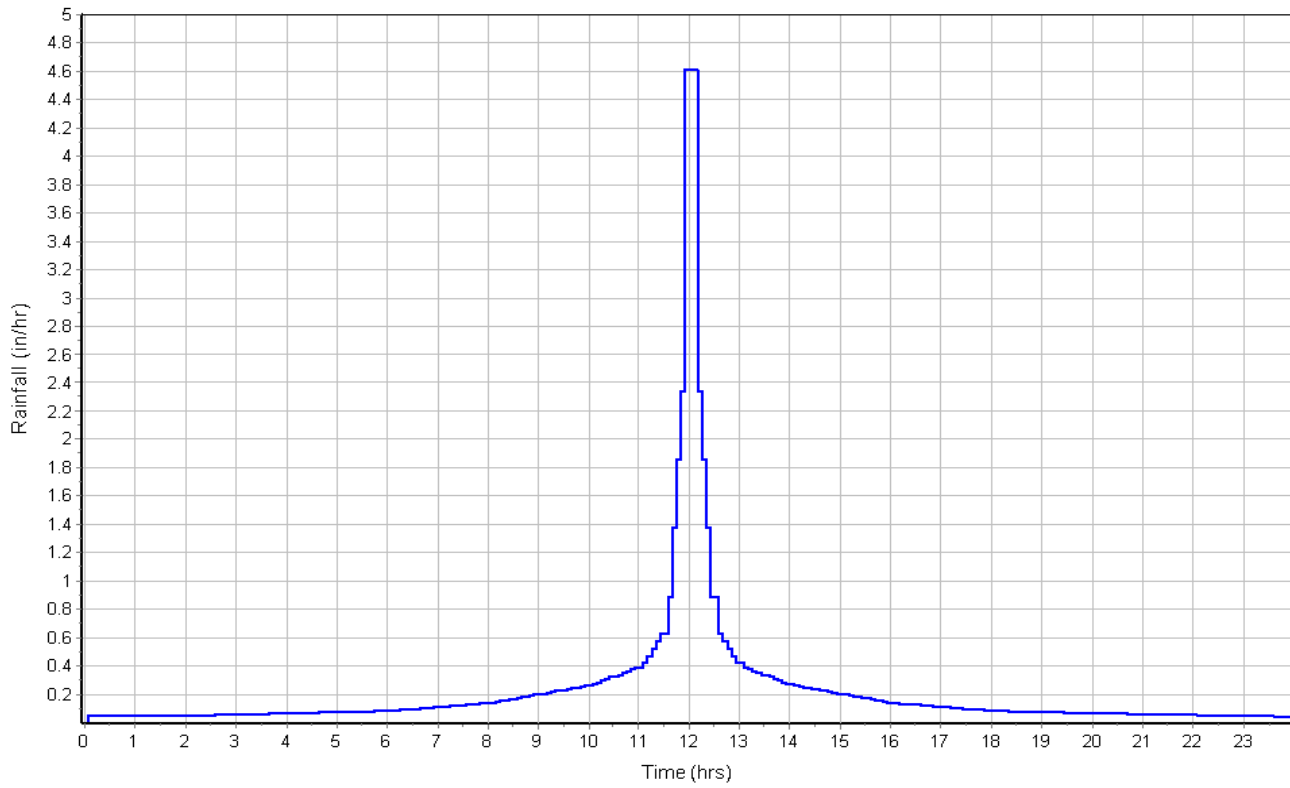

Runoff Hydrograph

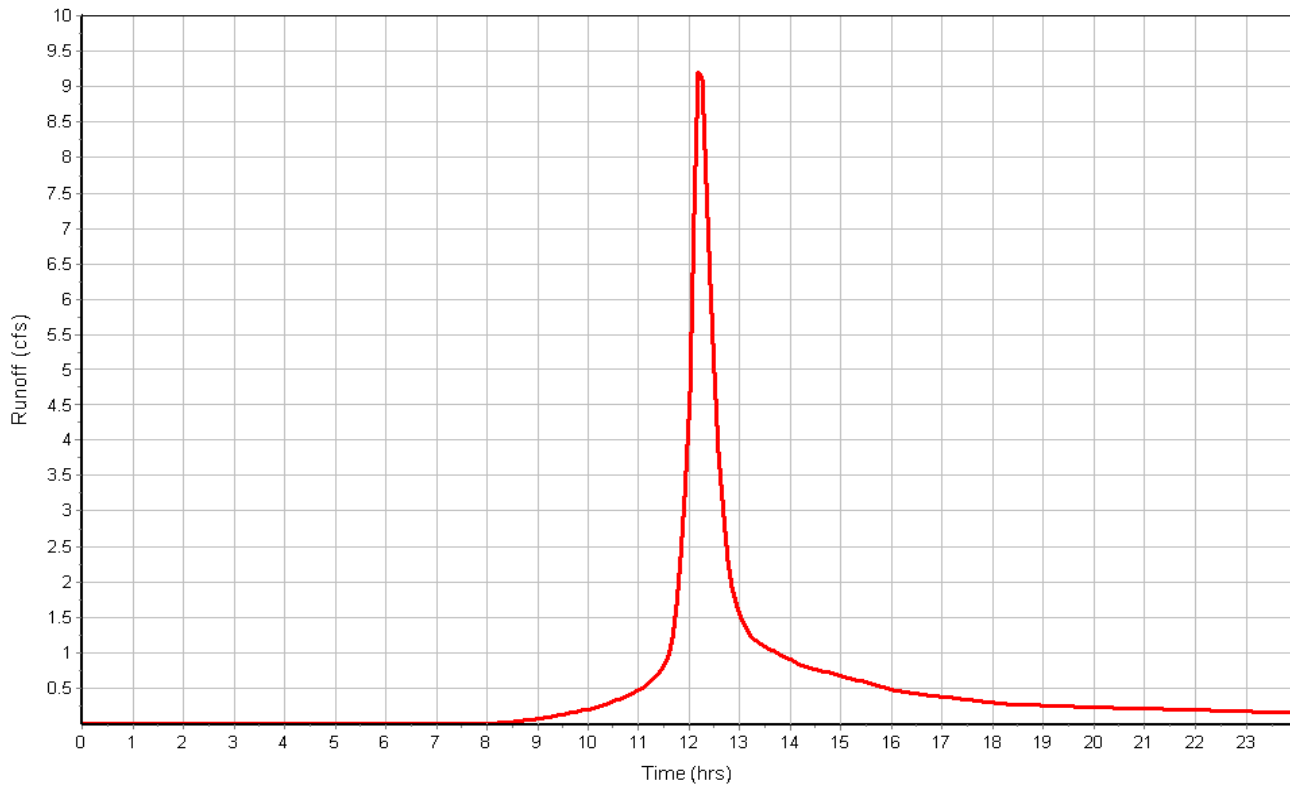

Project Description

File Name Proposed Conditions 7-2-18.SPF

Project Options

Flow Units CFS
 Elevation Type Elevation
 Hydrology Method SCS TR-55
 Time of Concentration (TOC) Method SCS TR-55
 Link Routing Method Kinematic Wave
 Enable Overflow Ponding at Nodes YES
 Skip Steady State Analysis Time Periods NO

Analysis Options

Start Analysis On Jul 13, 2017 00:00:00
 End Analysis On Jul 14, 2017 00:00:00
 Start Reporting On Jul 13, 2017 00:00:00
 Antecedent Dry Days 0 days
 Runoff (Dry Weather) Time Step 0 01:00:00 days hh:mm:ss
 Runoff (Wet Weather) Time Step 0 00:05:00 days hh:mm:ss
 Reporting Time Step 0 00:05:00 days hh:mm:ss
 Routing Time Step 30 seconds

Number of Elements

	Qty
Rain Gages	1
Subbasins.....	9
Nodes.....	16
<i>Junctions</i>	7
<i>Outfalls</i>	5
<i>Flow Diversions</i>	0
<i>Inlets</i>	0
<i>Storage Nodes</i>	4
Links.....	15
<i>Channels</i>	2
<i>Pipes</i>	5
<i>Pumps</i>	0
<i>Orifices</i>	5
<i>Weirs</i>	3
<i>Outlets</i>	0
Pollutants	0
Land Uses	0

Rainfall Details

SN	Rain Gage ID	Data Source	Data Source ID	Rainfall Type	Rain Units	State	County	Return Period (years)	Rainfall Depth (inches)	Rainfall Distribution
1	Rain Gage-01	Time Series	TS-02	Cumulative	inches	Maine	Androscoggin	2	3.04	SCS Type III 24-hr

Subbasin Summary

Subbasin ID	Area (ac)	Weighted Curve Number	Total Rainfall (in)	Total Runoff (in)	Total Runoff Volume (ac-in)	Peak Runoff (cfs)	Time of Concentration (days hh:mm:ss)
A1	12.28	73.16	3.04	0.89	10.93	5.33	0 00:49:44
A2	6.41	81.47	3.04	1.38	8.81	7.96	0 00:12:48
A3	4.01	71.75	3.04	0.82	3.29	2.99	0 00:09:08
B	5.14	75.65	3.04	1.02	5.26	3.66	0 00:24:28
C1-WETLAND	0.75	75.95	3.04	1.04	0.78	0.81	0 00:05:00
C2-WETLAND	0.73	82.63	3.04	1.45	1.06	0.74	0 00:27:24
C3-BYPASS	21.22	71.79	3.04	0.82	17.44	5.79	0 01:29:22
D	0.69	77.00	3.04	1.10	0.76	0.68	0 00:12:07
E	2.96	77.00	3.04	1.10	3.25	2.85	0 00:13:08

Node Summary

Element ID	Element Type	Invert Elevation
		(ft)
CB1	Junction	305.30
CB2	Junction	312.00
END-SECTION-C1	Junction	308.00
END-SECTION-C2	Junction	308.00
OUTLET-STR-A2	Junction	305.60
OUTLET-STR-C1	Junction	308.10
OUTLET-STR-C2	Junction	308.10
OUT-A	Outfall	298.00
OUT-B	Outfall	310.00
OUT-C	Outfall	298.00
OUT-D	Outfall	338.00
OUT-E	Outfall	298.00
DETENTION-A	Storage Node	309.50
FILTER-A2	Storage Node	308.00
WETLAND-C1	Storage Node	308.77
WETLAND-C2	Storage Node	308.77

Link Summary

Element ID	Element Type	From (Inlet) Node	To (Outlet) Node	Length (ft)	Inlet Invert Elevation (ft)	Outlet Invert Elevation (ft)	Average Slope (%)	Diameter or Height (in)	Manning's Roughness	Peak Flow (cfs)	Design Flow Capacity (cfs)	Peak Flow Velocity (ft/sec)	Peak Flow Depth (ft)
CULV-A	Pipe	CB1	OUT-A	98.00	305.30	305.12	0.1800	36.000	0.0150	7.21	24.77	3.04	1.11
CULV-A2-1	Pipe	CB2	FILTER-A2	104.00	312.00	310.00	1.9200	24.000	0.0150	7.91	27.19	7.52	0.74
CULV-A2-2	Pipe	OUTLET-STR-A2	CB1	43.00	305.60	305.30	0.7000	24.000	0.0150	5.34	16.38	4.66	0.79
CULV-C1	Pipe	OUTLET-STR-C1	END-SECTION-C1	30.00	308.10	308.00	0.3300	12.000	0.0130	0.02	2.06	0.81	0.07
CULV-C2	Pipe	OUTLET-STR-C2	END-SECTION-C2	30.00	308.10	308.00	0.3300	12.000	0.0130	0.02	2.06	0.83	0.07
WETLAND-CHANNEL-C1	Channel	END-SECTION-C1	OUT-C	2050.00	308.00	298.00	0.4900	6.000	0.0320	0.02	101.48	0.00	0.00
WETLAND-CHANNEL-C2	Channel	END-SECTION-C2	OUT-C	1712.00	308.00	298.00	0.5800	6.000	0.0320	0.02	111.05	0.00	0.00
BEEHIVE-GRATE	Orifice	DETENTION-A	CB1		309.50	305.30		18.167		0.00			
ORIF-A2	Orifice	FILTER-A2	OUTLET-STR-A2		308.00	305.60		6.000		5.34			
ORIF-C1	Orifice	WETLAND-C1	OUTLET-STR-C1		308.77	308.10		0.830		0.02			
ORIF-C2A	Orifice	WETLAND-C2	OUTLET-STR-C2		308.77	308.10		0.830		0.02			
ORIF-DET-A	Orifice	DETENTION-A	CB1		309.50	305.30		4.000		1.87			
SPILLWAY-A2	Weir	FILTER-A2	DETENTION-A		308.00	309.50				0.00			
SPILLWAY-C1	Weir	WETLAND-C1	END-SECTION-C1		308.77	308.00				0.00			
SPILLWAY-C2	Weir	WETLAND-C2	END-SECTION-C2		308.77	308.00				0.00			

Subbasin Hydrology

Subbasin : A1

Input Data

Area (ac) 12.28
Weighted Curve Number 73.16
Rain Gage ID Rain Gage-01

Composite Curve Number

Soil/Surface Description	Area (acres)	Soil Group	Curve Number
Woods, Good	4.58	D	77.00
> 75% grass cover, Good	0.68	C	74.00
Woods, Good	6.62	C	70.00
> 75% grass cover, Good	0.40	D	80.00
Composite Area & Weighted CN	12.28		73.16

Time of Concentration

TOC Method : SCS TR-55

Sheet Flow Equation :

$$T_c = (0.007 * ((n * L_f)^{0.8})) / ((P^{0.5}) * (S_f^{0.4}))$$

Where :

T_c = Time of Concentration (hr)
n = Manning's roughness
L_f = Flow Length (ft)
P = 2 yr, 24 hr Rainfall (inches)
S_f = Slope (ft/ft)

Shallow Concentrated Flow Equation :

V = 16.1345 * (S_f^{0.5}) (unpaved surface)
V = 20.3282 * (S_f^{0.5}) (paved surface)
V = 15.0 * (S_f^{0.5}) (grassed waterway surface)
V = 10.0 * (S_f^{0.5}) (nearly bare & untilled surface)
V = 9.0 * (S_f^{0.5}) (cultivated straight rows surface)
V = 7.0 * (S_f^{0.5}) (short grass pasture surface)
V = 5.0 * (S_f^{0.5}) (woodland surface)
V = 2.5 * (S_f^{0.5}) (forest w/heavy litter surface)
T_c = (L_f / V) / (3600 sec/hr)

Where:

T_c = Time of Concentration (hr)
L_f = Flow Length (ft)
V = Velocity (ft/sec)
S_f = Slope (ft/ft)

Channel Flow Equation :

$$V = (1.49 * (R^{2/3})) * (S_f^{0.5}) / n$$

$$R = A_q / W_p$$

$$T_c = (L_f / V) / (3600 \text{ sec/hr})$$

Where :

T_c = Time of Concentration (hr)
L_f = Flow Length (ft)
R = Hydraulic Radius (ft)
A_q = Flow Area (ft²)
W_p = Wetted Perimeter (ft)
V = Velocity (ft/sec)
S_f = Slope (ft/ft)
n = Manning's roughness

	Subarea	Subarea	Subarea
	A	B	C
Sheet Flow Computations			
Manning's Roughness :	.6	0.00	0.00
Flow Length (ft) :	100	0.00	0.00
Slope (%) :	2	0.00	0.00
2 yr, 24 hr Rainfall (in) :	3.00	0.00	0.00
Velocity (ft/sec) :	0.05	0.00	0.00
Computed Flow Time (min) :	30.68	0.00	0.00
	Subarea	Subarea	Subarea
	A	B	C
Shallow Concentrated Flow Computations			
Flow Length (ft) :	1510	0.00	0.00
Slope (%) :	.78	0.00	0.00
Surface Type :		Unpaved	Unpaved
Velocity (ft/sec) :	1.32	0.00	0.00
Computed Flow Time (min) :	19.07	0.00	0.00
Total TOC (min)	49.74		

Subbasin Runoff Results

Total Rainfall (in)	3.04
Total Runoff (in)	0.89
Peak Runoff (cfs)	5.33
Weighted Curve Number	73.16
Time of Concentration (days hh:mm:ss)	0 00:49:44

Subbasin : A1

Rainfall Intensity Graph

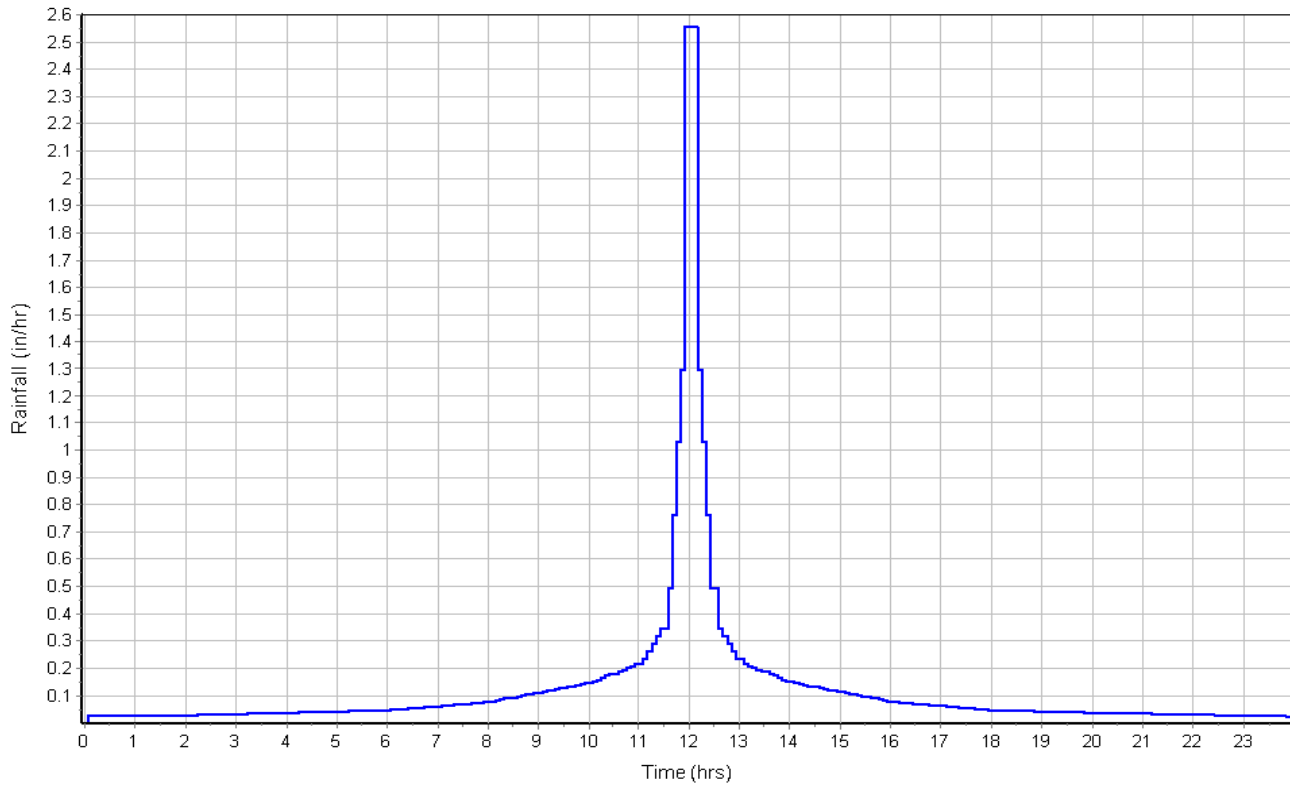

Runoff Hydrograph

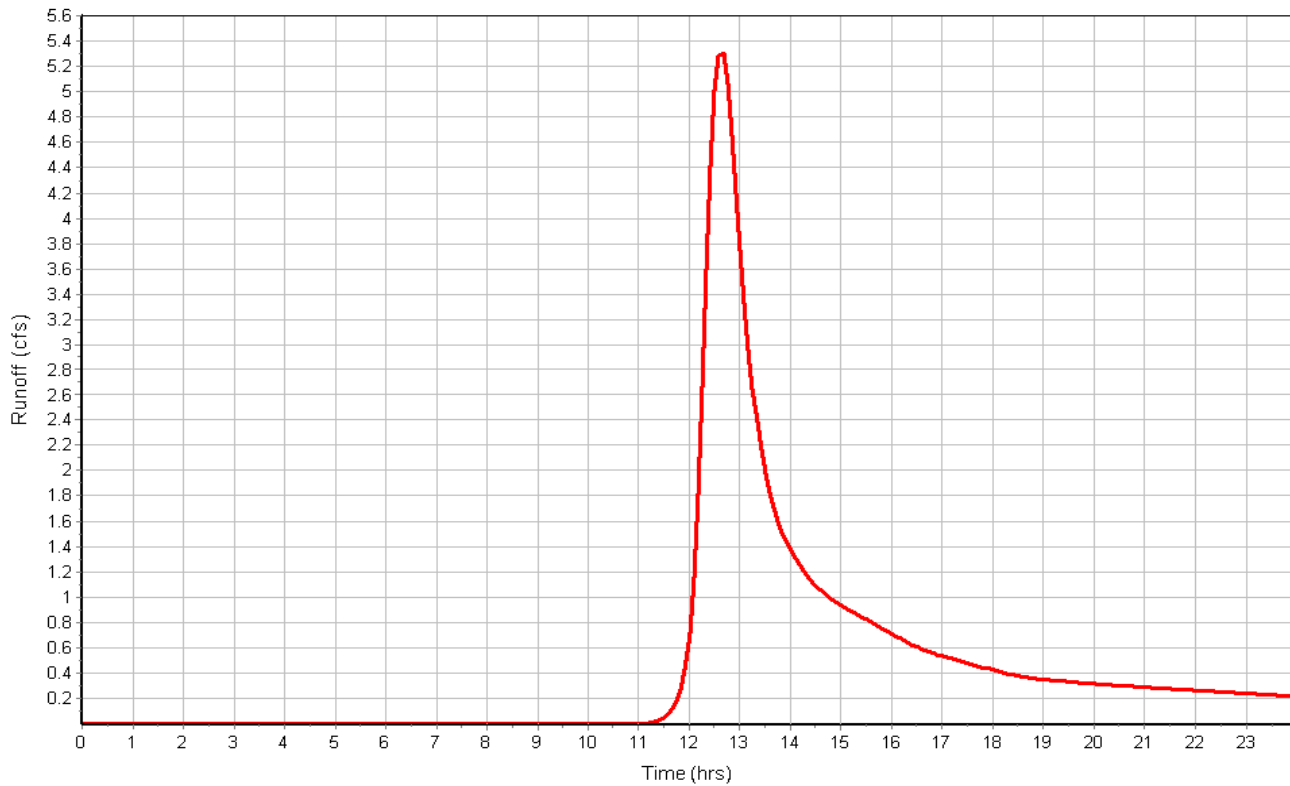

Subbasin : A2

Input Data

Area (ac) 6.41
 Weighted Curve Number 81.47
 Rain Gage ID Rain Gage-01

Composite Curve Number

Soil/Surface Description	Area (acres)	Soil Group	Curve Number
Woods, Good	0.13	D	77.00
Roofs	1.77	D	98.00
> 75% grass cover, Good	1.87	D	80.00
Stone_Pad	1.80	D	60.00
Gravel roads	0.17	D	91.00
Pavement	0.67	D	98.00
Composite Area & Weighted CN	6.41		81.47

Time of Concentration

	Subarea A	Subarea B	Subarea C
Sheet Flow Computations			
Manning's Roughness :	.4	0.00	0.00
Flow Length (ft) :	85	0.00	0.00
Slope (%) :	33.33	0.00	0.00
2 yr, 24 hr Rainfall (in) :	3.00	0.00	0.00
Velocity (ft/sec) :	0.22	0.00	0.00
Computed Flow Time (min) :	6.32	0.00	0.00
Channel Flow Computations			
Manning's Roughness :	.04	0.00	0.00
Flow Length (ft) :	1138	0.00	0.00
Channel Slope (%) :	1.4	0.00	0.00
Cross Section Area (ft ²) :	4.398	0.00	0.00
Wetted Perimeter (ft) :	8.12	0.00	0.00
Velocity (ft/sec) :	2.93	0.00	0.00
Computed Flow Time (min) :	6.48	0.00	0.00
Total TOC (min)	12.80		

Subbasin Runoff Results

Total Rainfall (in) 3.04
 Total Runoff (in) 1.38
 Peak Runoff (cfs) 7.96
 Weighted Curve Number 81.47
 Time of Concentration (days hh:mm:ss) 0 00:12:48

Subbasin : A2

Rainfall Intensity Graph

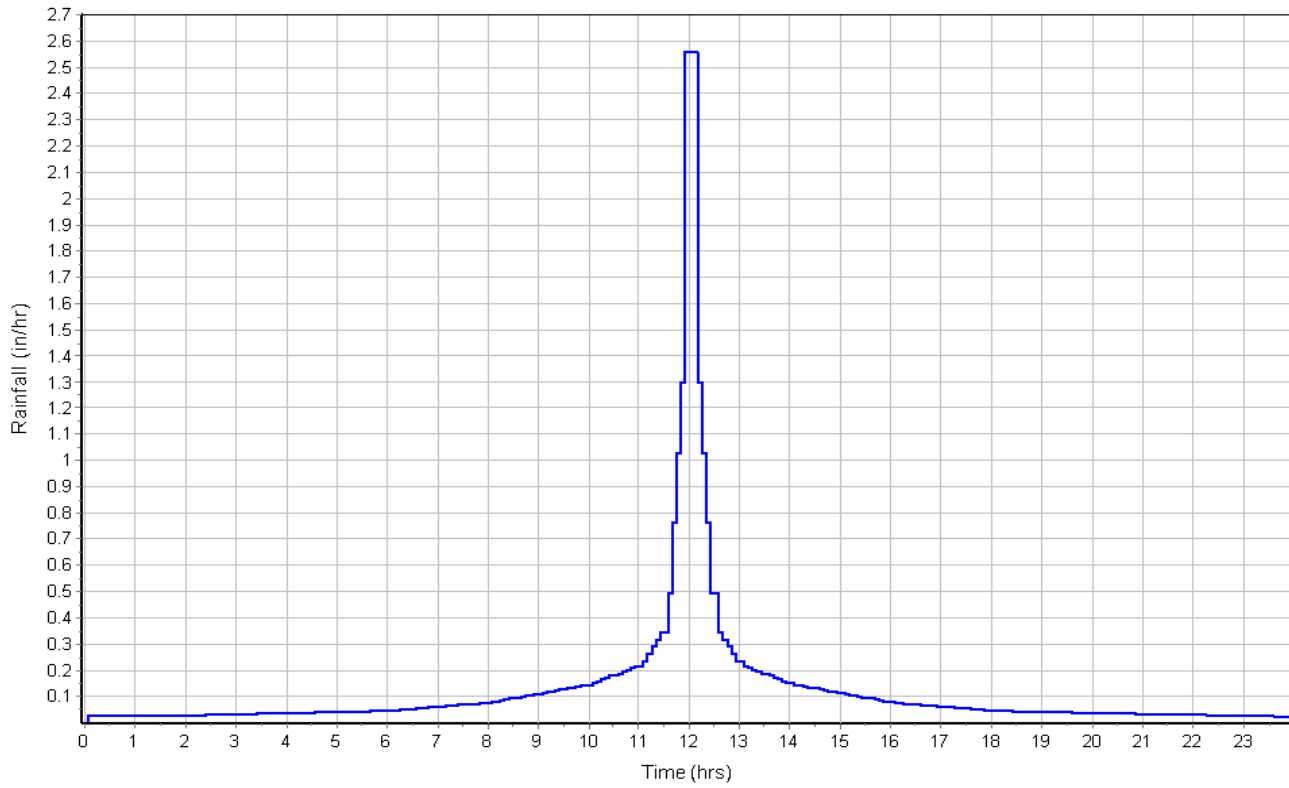

Runoff Hydrograph

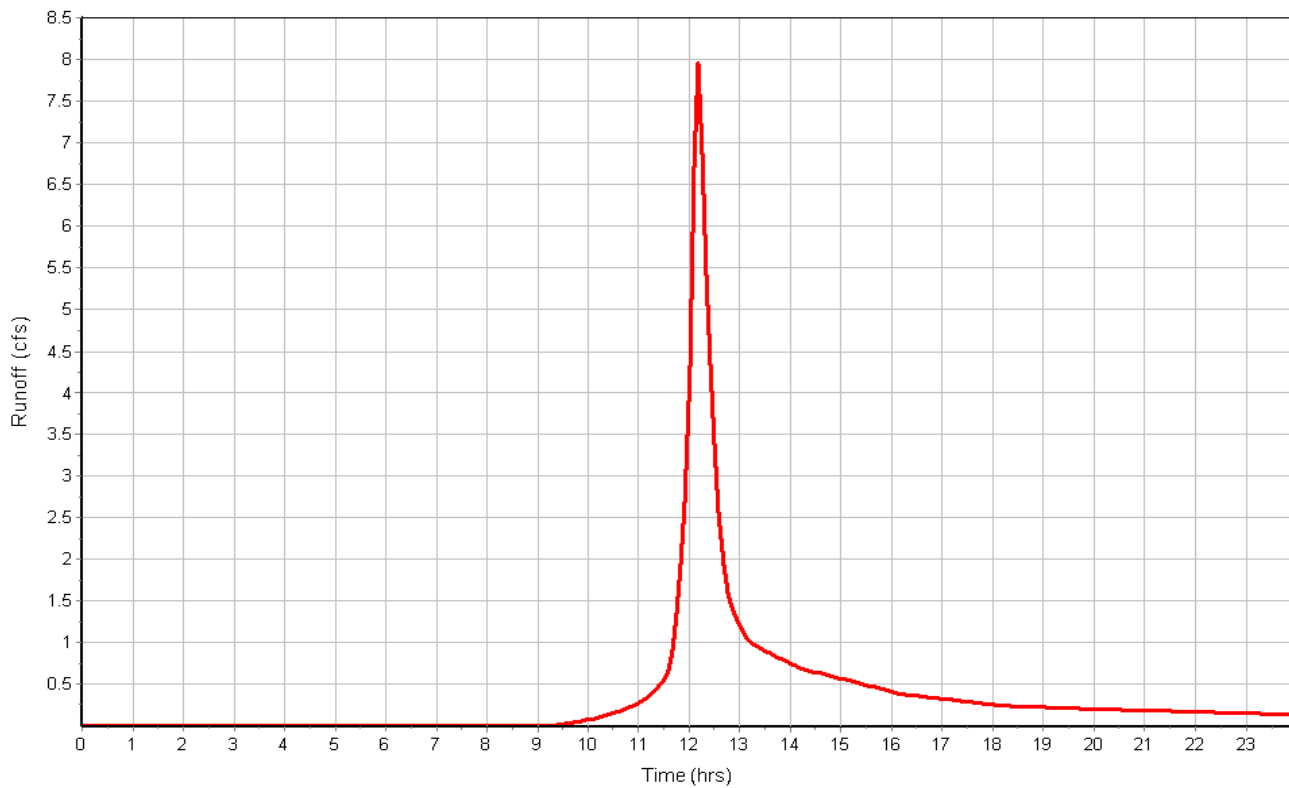

Subbasin : A3

Input Data

Area (ac) 4.01
 Weighted Curve Number 71.75
 Rain Gage ID Rain Gage-01

Composite Curve Number

Soil/Surface Description	Area (acres)	Soil Group	Curve Number
> 75% grass cover, Good	0.75	D	80.00
> 75% grass cover, Good	0.14	C	74.00
Stone_Pad	2.28	D	60.00
Roofs	0.19	D	98.00
Gravel roads	0.25	D	91.00
Pavement	0.35	D	98.00
Foundations	0.05	D	98.00
Composite Area & Weighted CN	4.01		71.75

Time of Concentration

Sheet Flow Computations	Subarea	Subarea	Subarea
	A	B	C
Manning's Roughness :	.01	0.00	0.00
Flow Length (ft) :	100	0.00	0.00
Slope (%) :	2	0.00	0.00
2 yr, 24 hr Rainfall (in) :	3.00	0.00	0.00
Velocity (ft/sec) :	1.44	0.00	0.00
Computed Flow Time (min) :	1.16	0.00	0.00

Shallow Concentrated Flow Computations	Subarea	Subarea	Subarea
	A	B	C
Flow Length (ft) :	548	25	200
Slope (%) :	2	33.33	1.5
Surface Type :	Unpaved		
Velocity (ft/sec) :	2.28	4.04	0.86
Computed Flow Time (min) :	4.01	0.10	3.88
Total TOC (min)	9.14		

Subbasin Runoff Results

Total Rainfall (in) 3.04
 Total Runoff (in) 0.82
 Peak Runoff (cfs) 2.99
 Weighted Curve Number 71.75
 Time of Concentration (days hh:mm:ss) 0 00:09:08

Subbasin : A3

Rainfall Intensity Graph

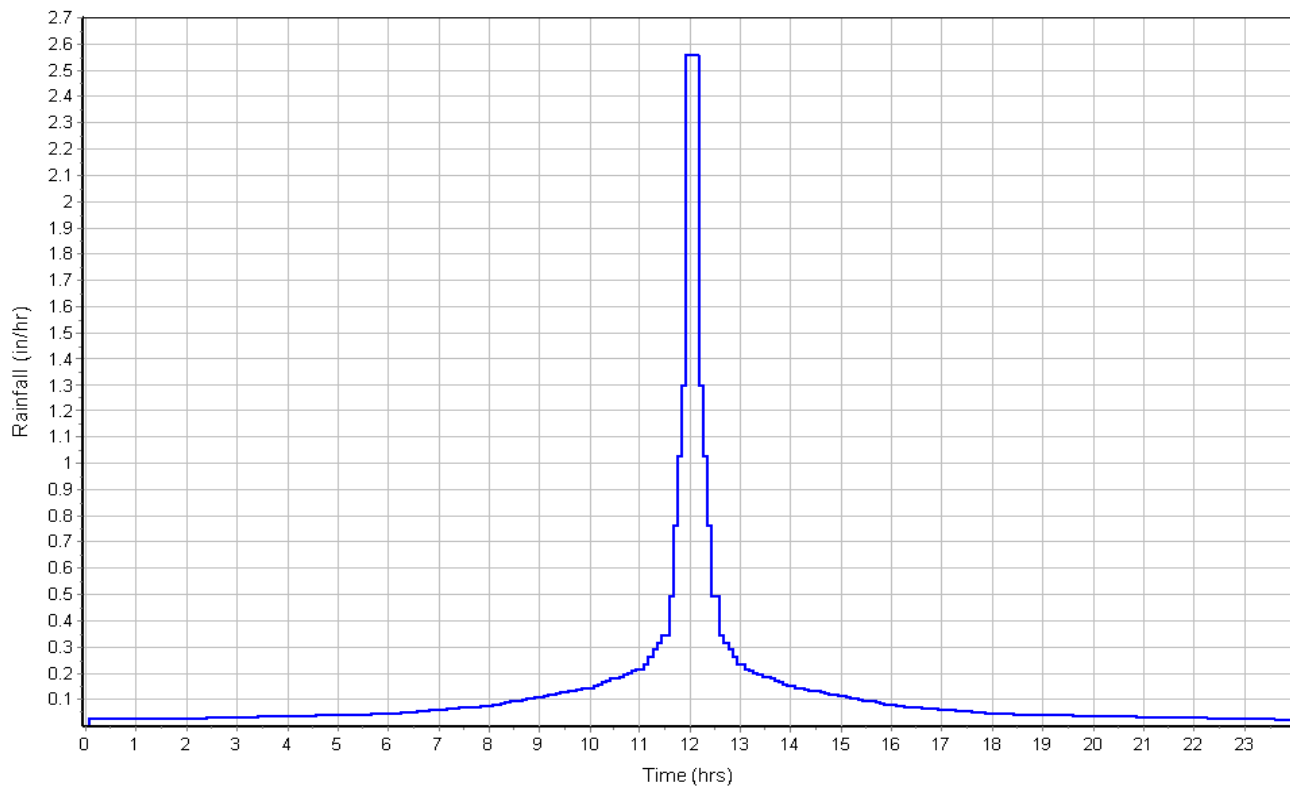

Runoff Hydrograph

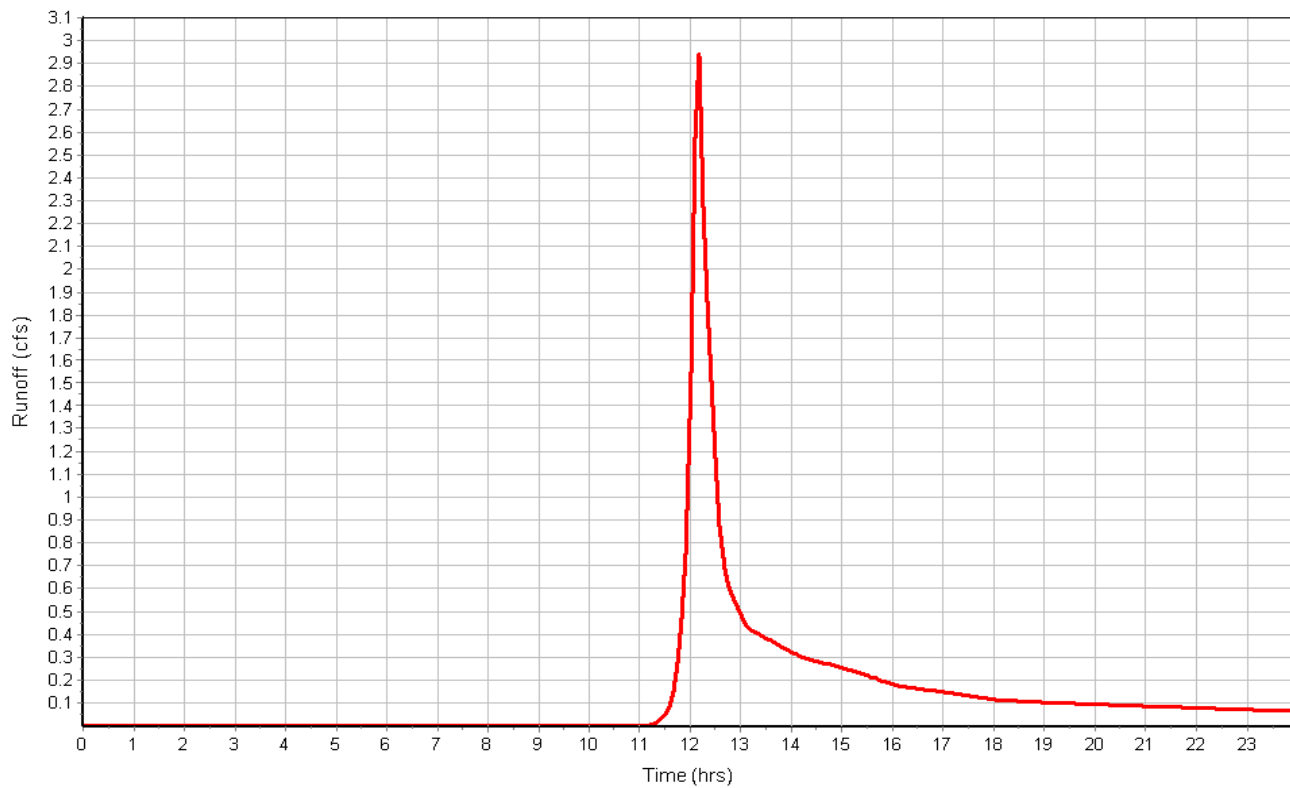

Subbasin : B

Input Data

Area (ac) 5.14
 Weighted Curve Number 75.65
 Rain Gage ID Rain Gage-01

Composite Curve Number

Soil/Surface Description	Area (acres)	Soil Group	Curve Number
Woods, Good	1.20	C	70.00
Woods, Good	3.45	D	77.00
> 75% grass cover, Good	0.49	D	80.00
Composite Area & Weighted CN	5.14		75.65

Time of Concentration

	Subarea A	Subarea B	Subarea C
Sheet Flow Computations			
Manning's Roughness :	.4	0.00	0.00
Flow Length (ft) :	90	0.00	0.00
Slope (%) :	33.33	0.00	0.00
2 yr, 24 hr Rainfall (in) :	3.00	0.00	0.00
Velocity (ft/sec) :	0.23	0.00	0.00
Computed Flow Time (min) :	6.62	0.00	0.00
Shallow Concentrated Flow Computations			
Flow Length (ft) :	368	0.00	0.00
Slope (%) :	1.63	0.00	0.00
Surface Type :		Unpaved	Unpaved
Velocity (ft/sec) :	1.92	0.00	0.00
Computed Flow Time (min) :	3.19	0.00	0.00
Channel Flow Computations			
Manning's Roughness :	.3	.3	0.00
Flow Length (ft) :	272	85	0.00
Channel Slope (%) :	1.4	16.7	0.00
Cross Section Area (ft²) :	3.287	1.367	0.00
Wetted Perimeter (ft) :	7.17	5.15	0.00
Velocity (ft/sec) :	0.35	0.84	0.00
Computed Flow Time (min) :	12.97	1.69	0.00
Total TOC (min)	24.48		

Subbasin Runoff Results

Total Rainfall (in) 3.04
 Total Runoff (in) 1.02
 Peak Runoff (cfs) 3.66
 Weighted Curve Number 75.65
 Time of Concentration (days hh:mm:ss) 0 00:24:29

Subbasin : B

Rainfall Intensity Graph

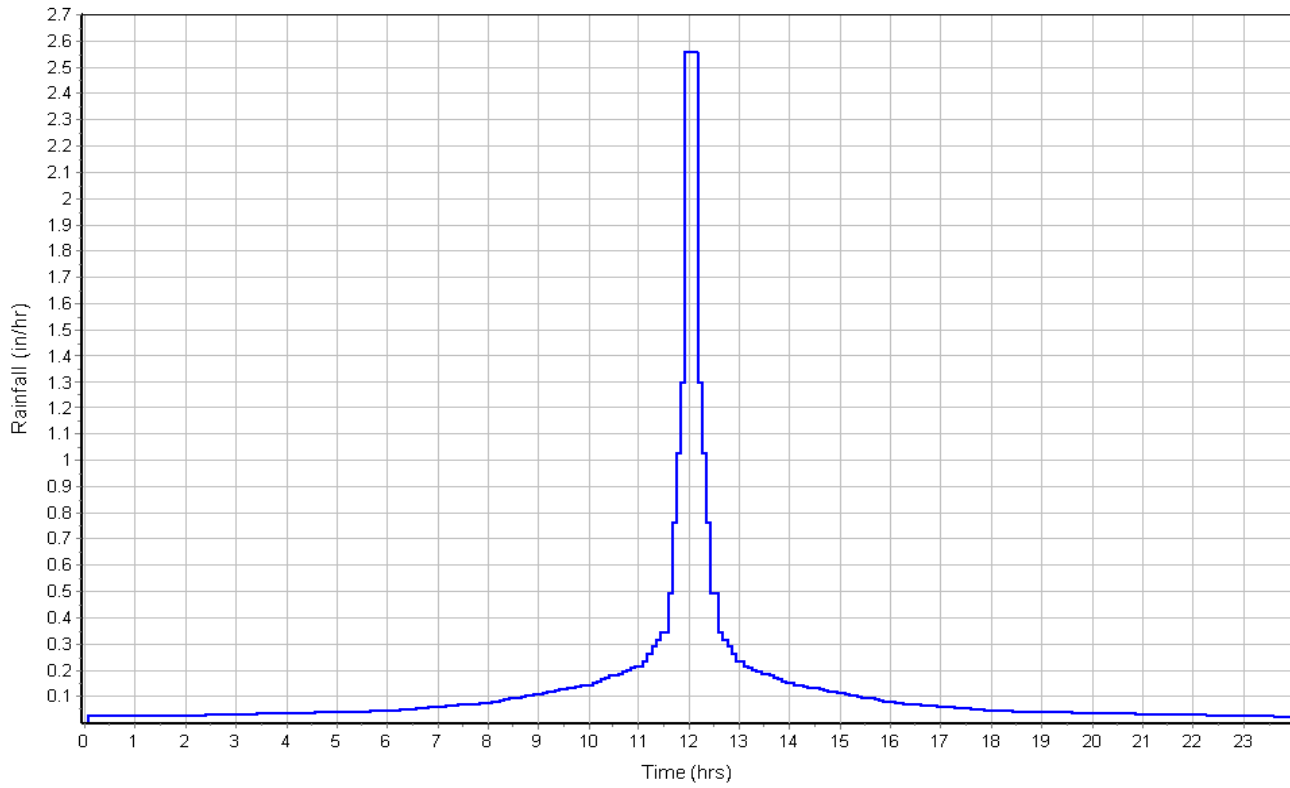

Runoff Hydrograph

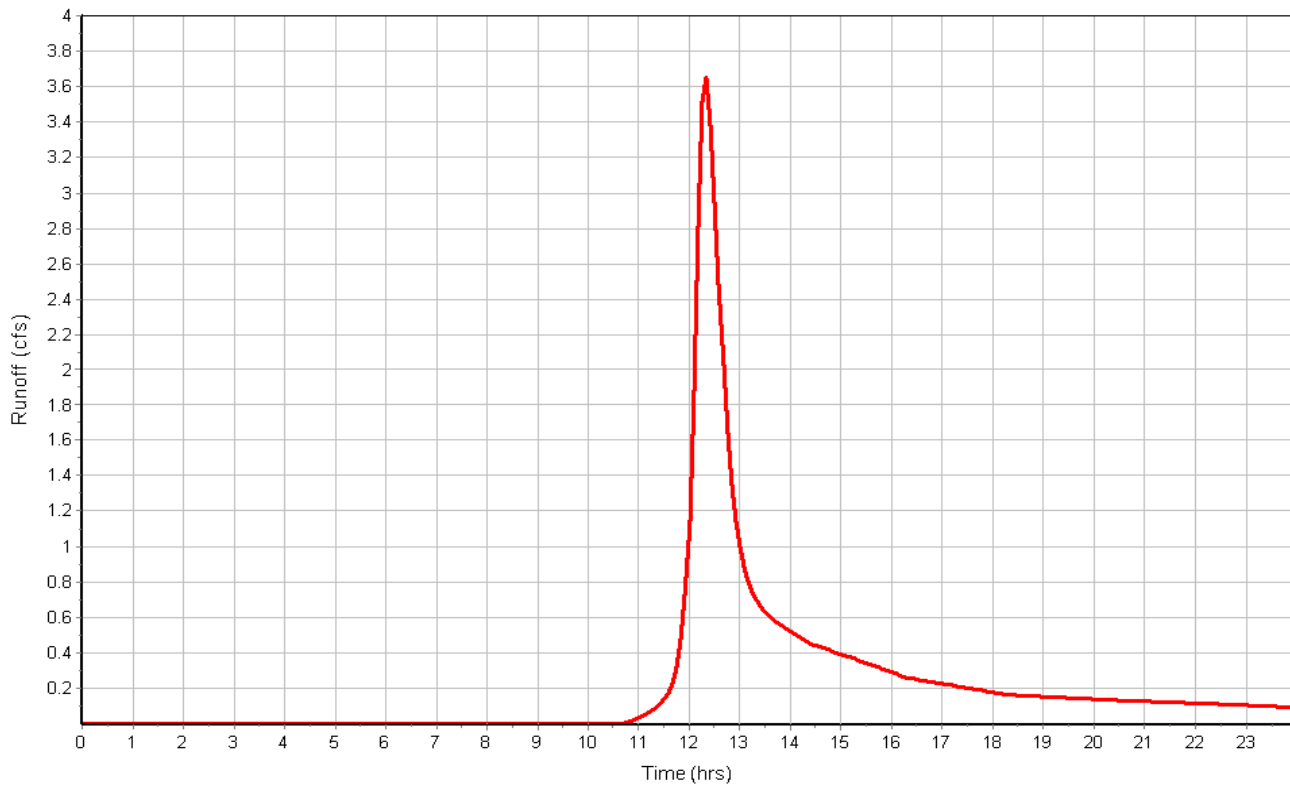

Subbasin : C1-WETLAND

Input Data

Area (ac) 0.75
 Weighted Curve Number 75.95
 Rain Gage ID Rain Gage-01

Composite Curve Number

Soil/Surface Description	Area (acres)	Soil Group	Curve Number
Woods, Good	0.12	D	77.00
> 75% grass cover, Good	0.04	A	39.00
> 75% grass cover, Good	0.05	D	80.00
> 75% grass cover, Good	0.34	C	74.00
Woods, Good	0.02	C	70.00
Gravel roads	0.04	A	76.00
Gravel roads	0.09	C	89.00
Gravel roads	0.05	D	91.00
Composite Area & Weighted CN	0.75		75.95

Time of Concentration

User-Defined TOC override (minutes): 5

Subbasin Runoff Results

Total Rainfall (in) 3.04
 Total Runoff (in) 1.04
 Peak Runoff (cfs) 0.81
 Weighted Curve Number 75.95
 Time of Concentration (days hh:mm:ss) 0 00:05:00

Subbasin : C1-WETLAND

Rainfall Intensity Graph

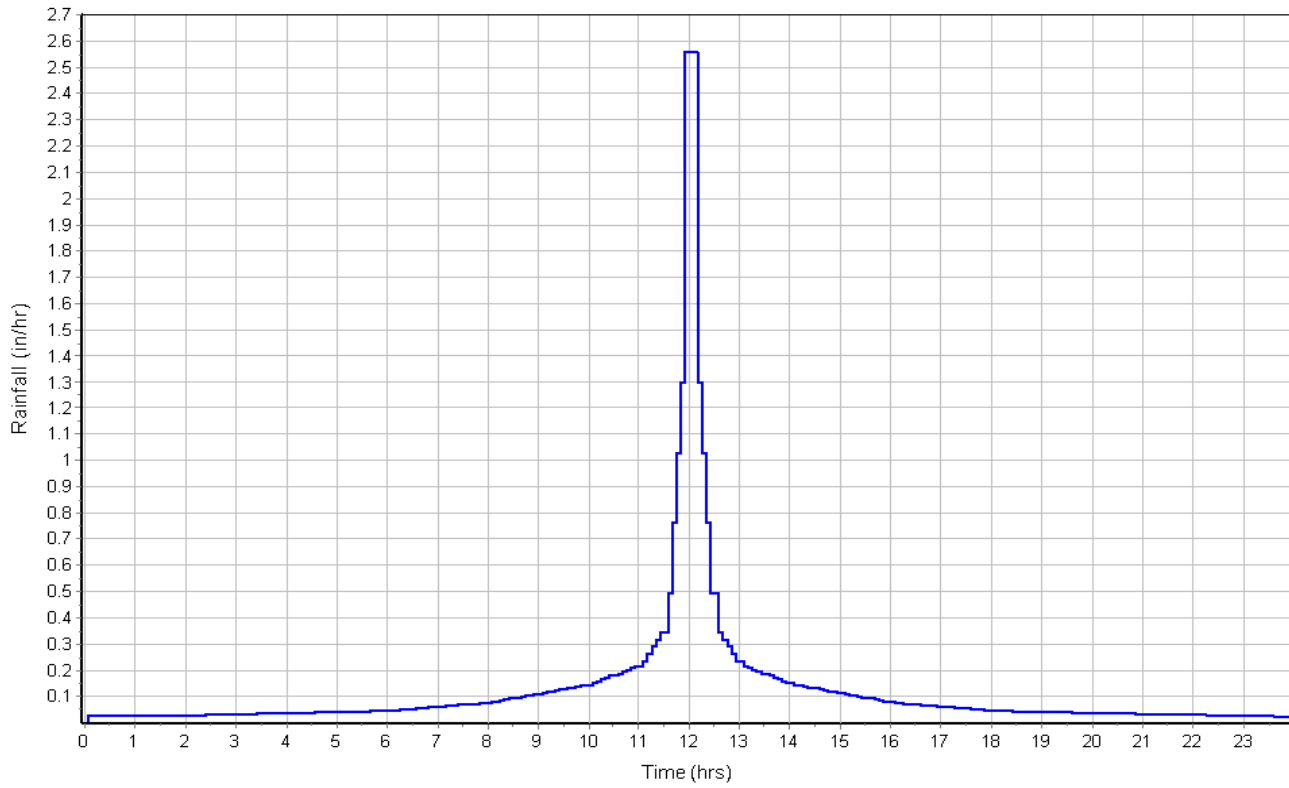

Runoff Hydrograph

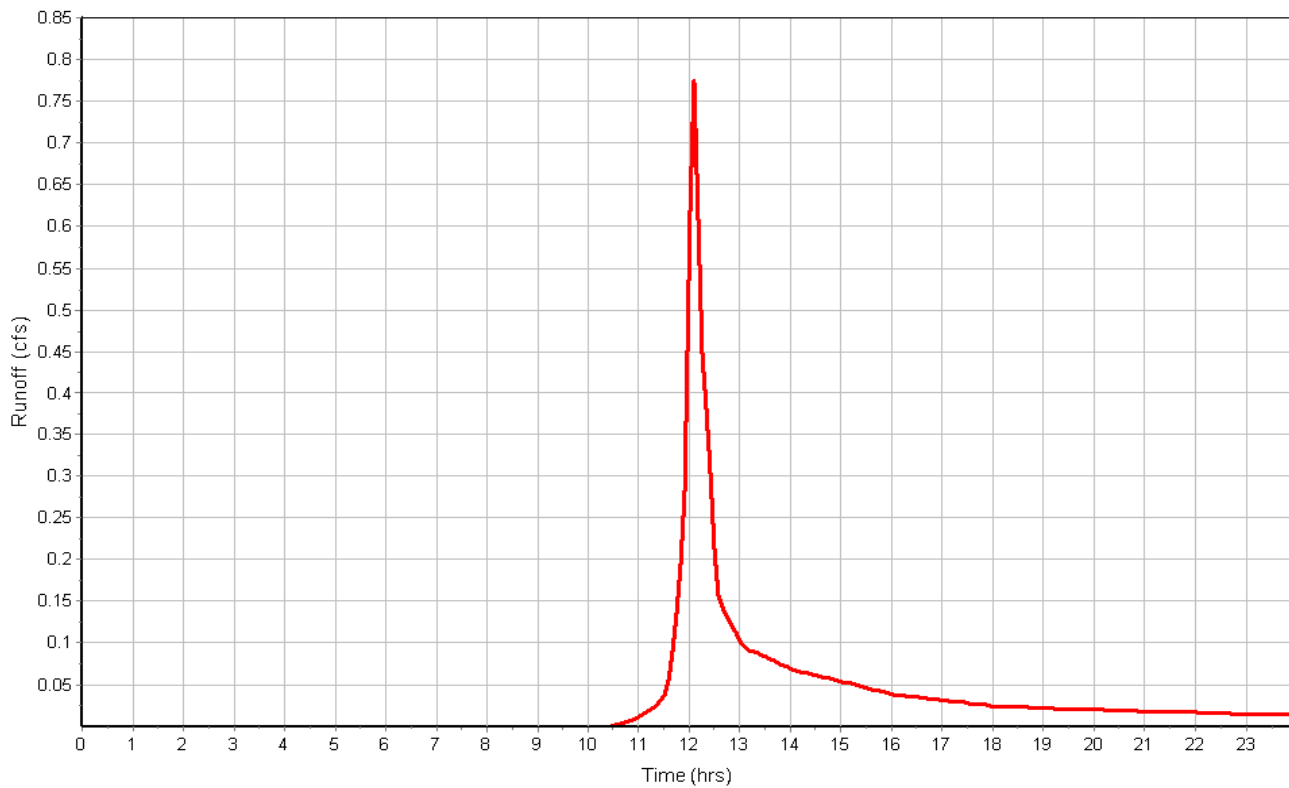

Subbasin : C2-WETLAND

Input Data

Area (ac) 0.73
 Weighted Curve Number 82.63
 Rain Gage ID Rain Gage-01

Composite Curve Number

Soil/Surface Description	Area (acres)	Soil Group	Curve Number
> 75% grass cover, Good	0.31	C	74.00
Gravel roads	0.42	C	89.00
Composite Area & Weighted CN	0.73		82.63

Time of Concentration

Sheet Flow Computations	Subarea	Subarea	Subarea
	A	B	C
Manning's Roughness :	.01	0.00	0.00
Flow Length (ft) :	44	0.00	0.00
Slope (%) :	2	0.00	0.00
2 yr, 24 hr Rainfall (in) :	3.00	0.00	0.00
Velocity (ft/sec) :	1.22	0.00	0.00
Computed Flow Time (min) :	0.60	0.00	0.00

Shallow Concentrated Flow Computations	Subarea	Subarea	Subarea
	A	B	C
Flow Length (ft) :	636	0.00	0.00
Slope (%) :	1.6	0.00	0.00
Surface Type :	Grassed waterway	Unpaved	Unpaved
Velocity (ft/sec) :	1.90	0.00	0.00
Computed Flow Time (min) :	5.58	0.00	0.00

Channel Flow Computations	Subarea	Subarea	Subarea
	A	B	C
Manning's Roughness :	.03	0.00	0.00
Flow Length (ft) :	2256	0.00	0.00
Channel Slope (%) :	.5	0.00	0.00
Cross Section Area (ft ²) :	2.475	0.00	0.00
Wetted Perimeter (ft) :	6.91	0.00	0.00
Velocity (ft/sec) :	1.77	0.00	0.00
Computed Flow Time (min) :	21.23	0.00	0.00
Total TOC (min)	27.41		

Subbasin Runoff Results

Total Rainfall (in) 3.04
 Total Runoff (in) 1.45
 Peak Runoff (cfs) 0.74
 Weighted Curve Number 82.63
 Time of Concentration (days hh:mm:ss) 0 00:27:25

Subbasin : C2-WETLAND

Rainfall Intensity Graph

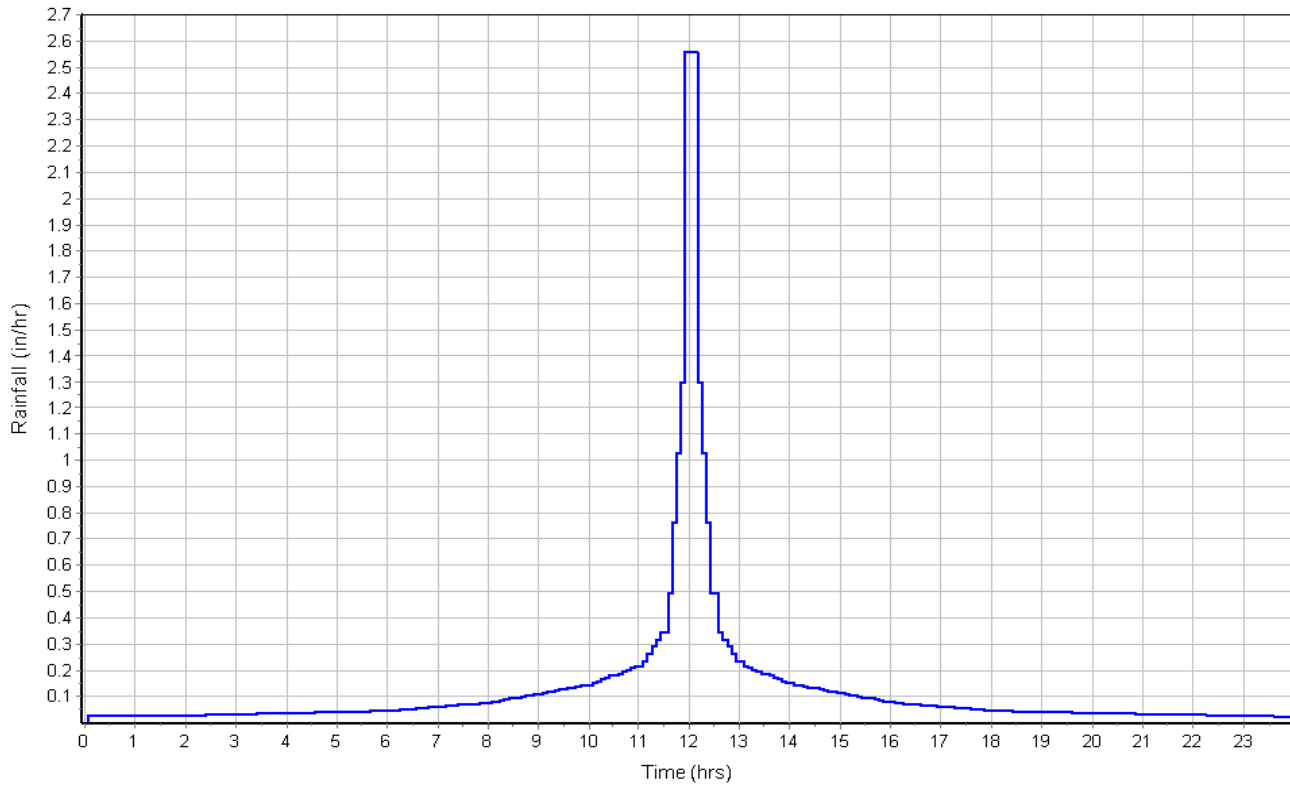

Runoff Hydrograph

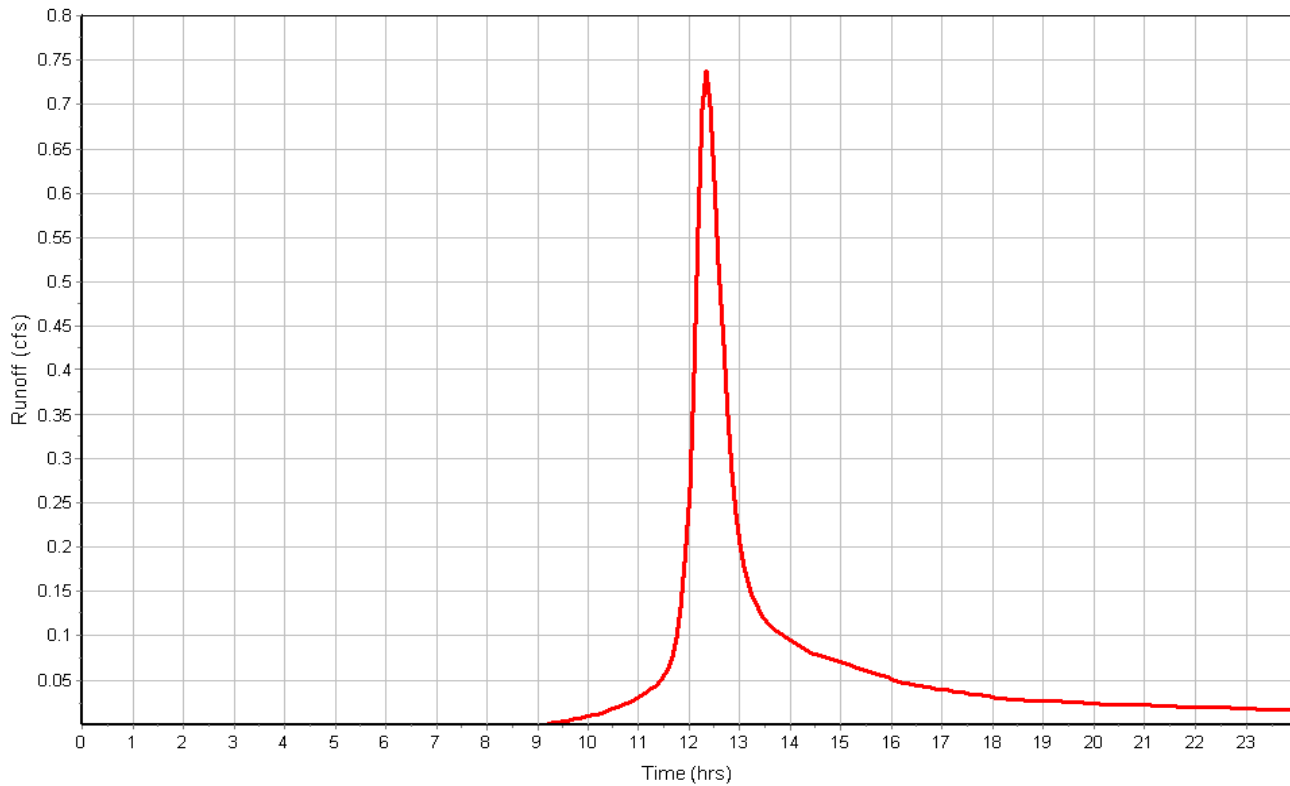

Subbasin : C3-BYPASS

Input Data

Area (ac) 21.22
 Weighted Curve Number 71.79
 Rain Gage ID Rain Gage-01

Composite Curve Number

Soil/Surface Description	Area (acres)	Soil Group	Curve Number
> 75% grass cover, Good	0.01	D	80.00
Woods, Good	12.33	C	70.00
Woods, Good	7.45	D	77.00
> 75% grass cover, Good	0.66	A	39.00
> 75% grass cover, Good	0.57	C	74.00
Gravel roads	0.20	C	89.00
Composite Area & Weighted CN	21.22		71.79

Time of Concentration

	Subarea	Subarea	Subarea
	A	B	C
Sheet Flow Computations			
Manning's Roughness :	.6	0.00	0.00
Flow Length (ft) :	100	0.00	0.00
Slope (%) :	.47	0.00	0.00
2 yr, 24 hr Rainfall (in) :	3.00	0.00	0.00
Velocity (ft/sec) :	0.03	0.00	0.00
Computed Flow Time (min) :	54.75	0.00	0.00
Shallow Concentrated Flow Computations			
Flow Length (ft) :	2140	0.00	0.00
Slope (%) :	.47	0.00	0.00
Surface Type :	Grassed waterway	Unpaved	Unpaved
Velocity (ft/sec) :	1.03	0.00	0.00
Computed Flow Time (min) :	34.63	0.00	0.00
Total TOC (min)	89.38		

Subbasin Runoff Results

Total Rainfall (in) 3.04
 Total Runoff (in) 0.82
 Peak Runoff (cfs) 5.79
 Weighted Curve Number 71.79
 Time of Concentration (days hh:mm:ss) 0 01:29:23

Subbasin : C3-BYPASS

Rainfall Intensity Graph

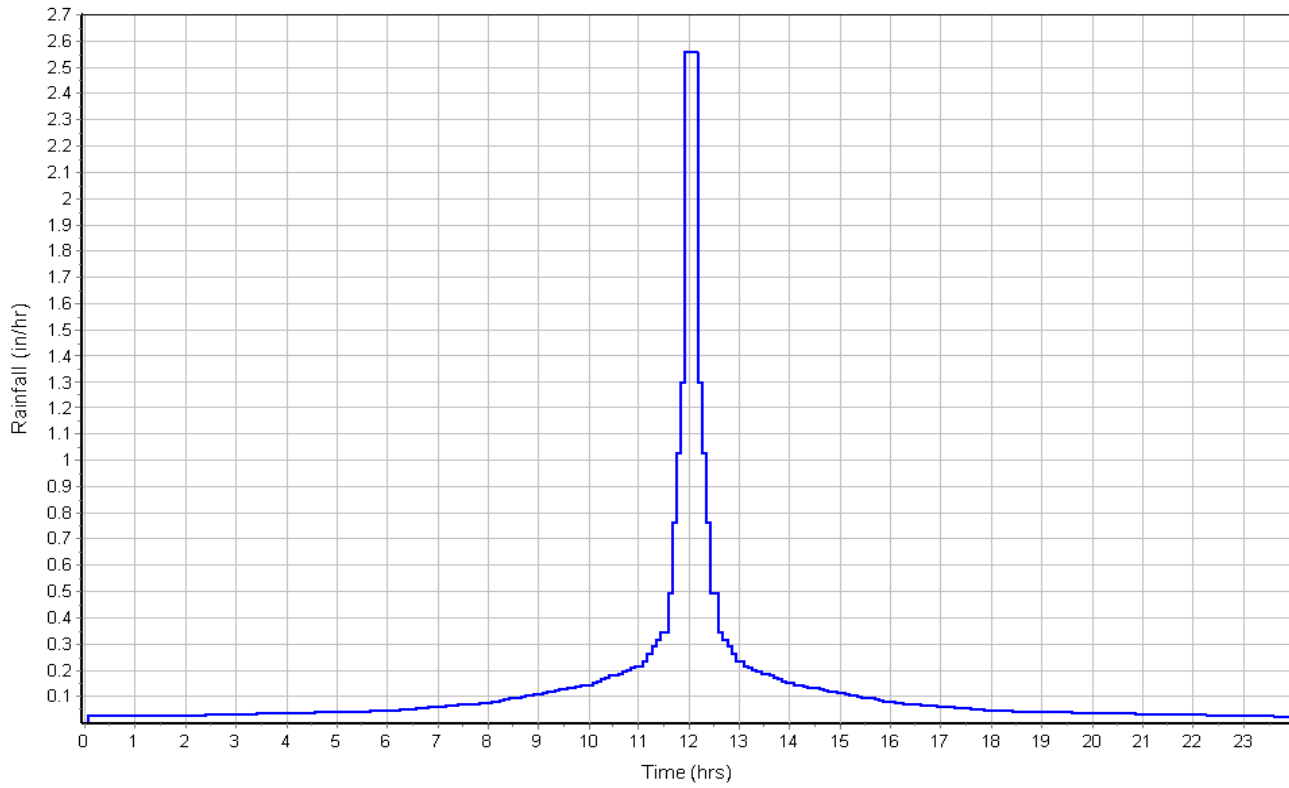

Runoff Hydrograph

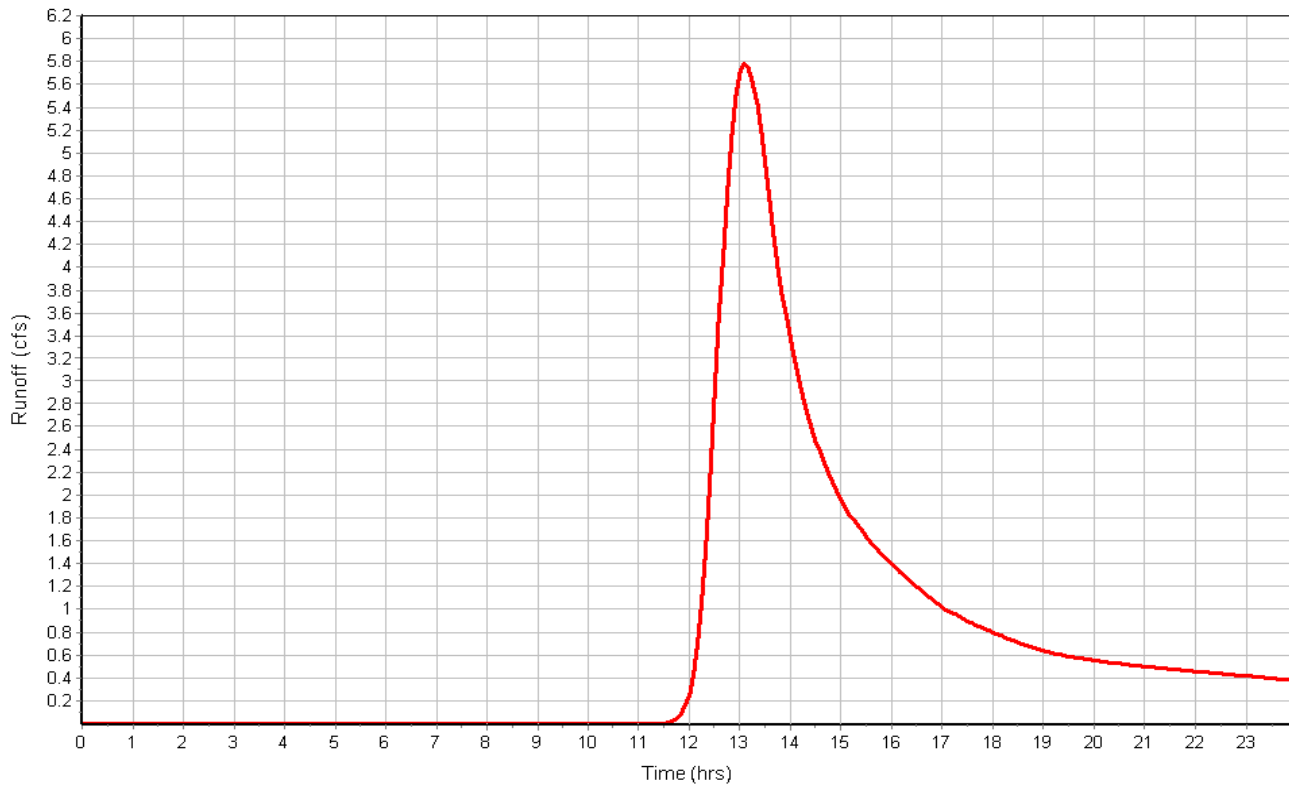

Subbasin : D

Input Data

Area (ac) 0.69
 Weighted Curve Number 77.00
 Rain Gage ID Rain Gage-01

Composite Curve Number

Soil/Surface Description	Area (acres)	Soil Group	Curve Number
Woods, Good	0.74	D	77.00
Composite Area & Weighted CN	0.74		77.00

Time of Concentration

Sheet Flow Computations	Subarea	Subarea	Subarea
	A	B	C
Manning's Roughness :	.6	0.00	0.00
Flow Length (ft) :	100	0.00	0.00
Slope (%) :	21	0.00	0.00
2 yr, 24 hr Rainfall (in) :	3.00	0.00	0.00
Velocity (ft/sec) :	0.14	0.00	0.00
Computed Flow Time (min) :	11.98	0.00	0.00

Shallow Concentrated Flow Computations	Subarea	Subarea	Subarea
	A	B	C
Flow Length (ft) :	16	0.00	0.00
Slope (%) :	14.5	0.00	0.00
Surface Type :	Woodland	Unpaved	Unpaved
Velocity (ft/sec) :	1.90	0.00	0.00
Computed Flow Time (min) :	0.14	0.00	0.00
Total TOC (min)	12.12		

Subbasin Runoff Results

Total Rainfall (in) 3.04
 Total Runoff (in) 1.10
 Peak Runoff (cfs) 0.68
 Weighted Curve Number 77.00
 Time of Concentration (days hh:mm:ss) 0 00:12:07

Subbasin : D

Rainfall Intensity Graph

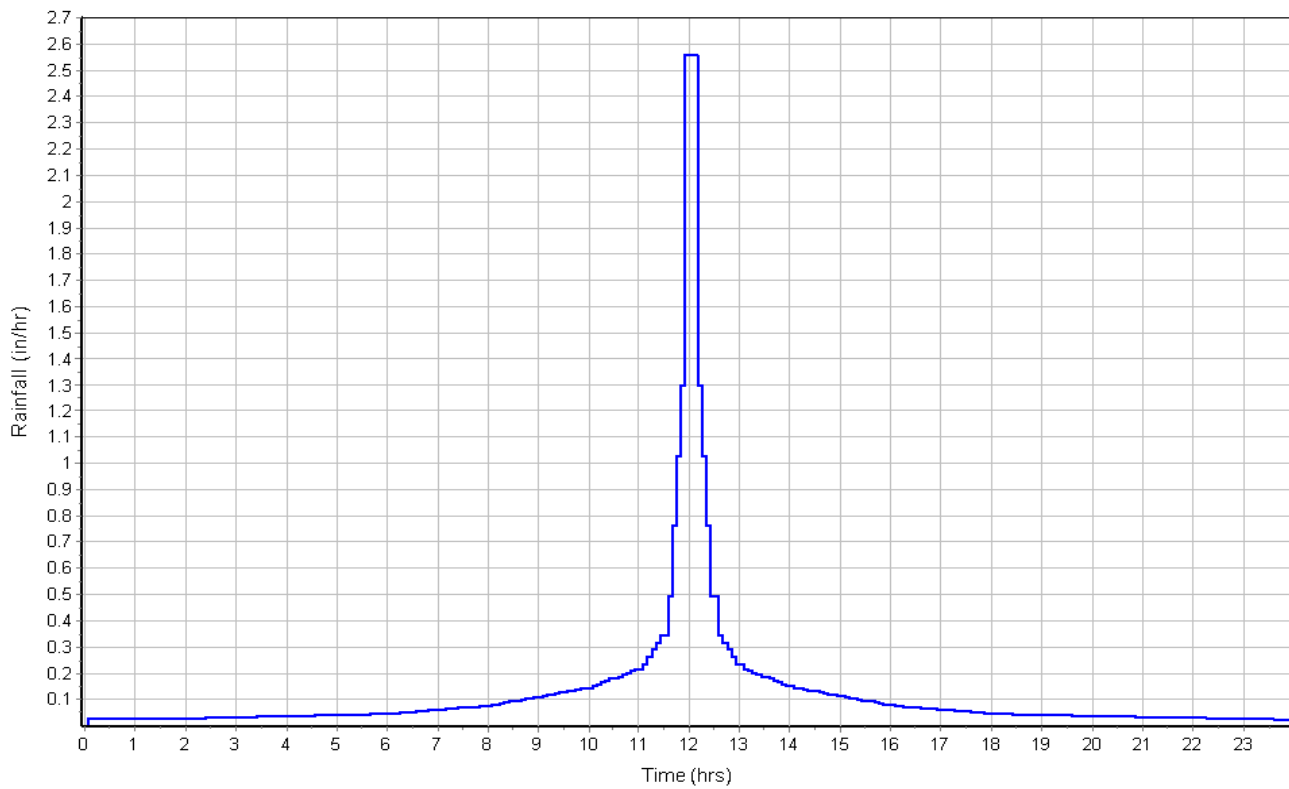

Runoff Hydrograph

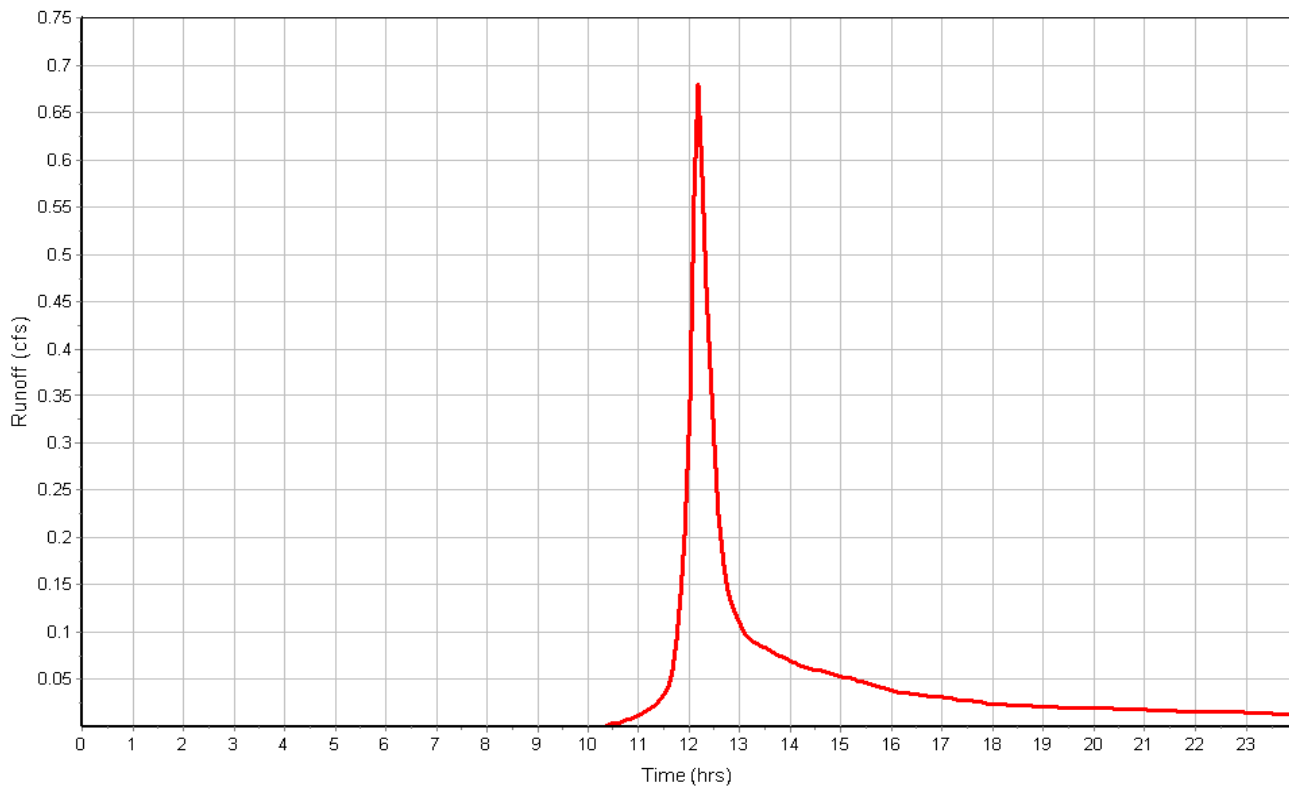

Subbasin : E

Input Data

Area (ac) 2.96
 Weighted Curve Number 77.00
 Rain Gage ID Rain Gage-01

Composite Curve Number

Soil/Surface Description	Area (acres)	Soil Group	Curve Number
Woods, Good	2.96	D	77.00
Composite Area & Weighted CN	2.96		77.00

Time of Concentration

Sheet Flow Computations	Subarea	Subarea	Subarea
	A	B	C
Manning's Roughness :	.6	0.00	0.00
Flow Length (ft) :	100	0.00	0.00
Slope (%) :	24	0.00	0.00
2 yr, 24 hr Rainfall (in) :	3.00	0.00	0.00
Velocity (ft/sec) :	0.15	0.00	0.00
Computed Flow Time (min) :	11.35	0.00	0.00

Shallow Concentrated Flow Computations	Subarea	Subarea	Subarea
	A	B	C
Flow Length (ft) :	227	0.00	0.00
Slope (%) :	18	0.00	0.00
Surface Type :	Woodland	Unpaved	Unpaved
Velocity (ft/sec) :	2.12	0.00	0.00
Computed Flow Time (min) :	1.78	0.00	0.00
Total TOC (min)	13.14		

Subbasin Runoff Results

Total Rainfall (in) 3.04
 Total Runoff (in) 1.10
 Peak Runoff (cfs) 2.85
 Weighted Curve Number 77.00
 Time of Concentration (days hh:mm:ss) 0 00:13:08

Subbasin : E

Rainfall Intensity Graph

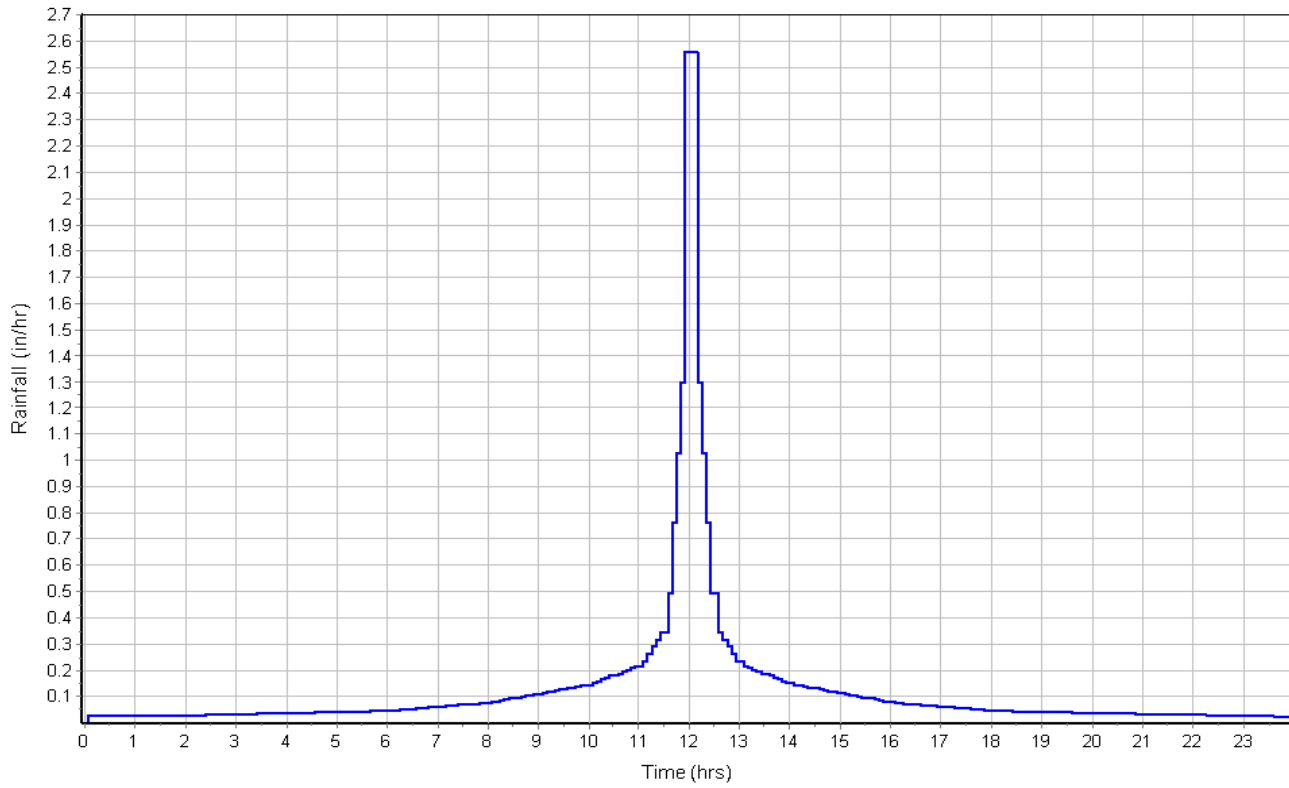

Runoff Hydrograph

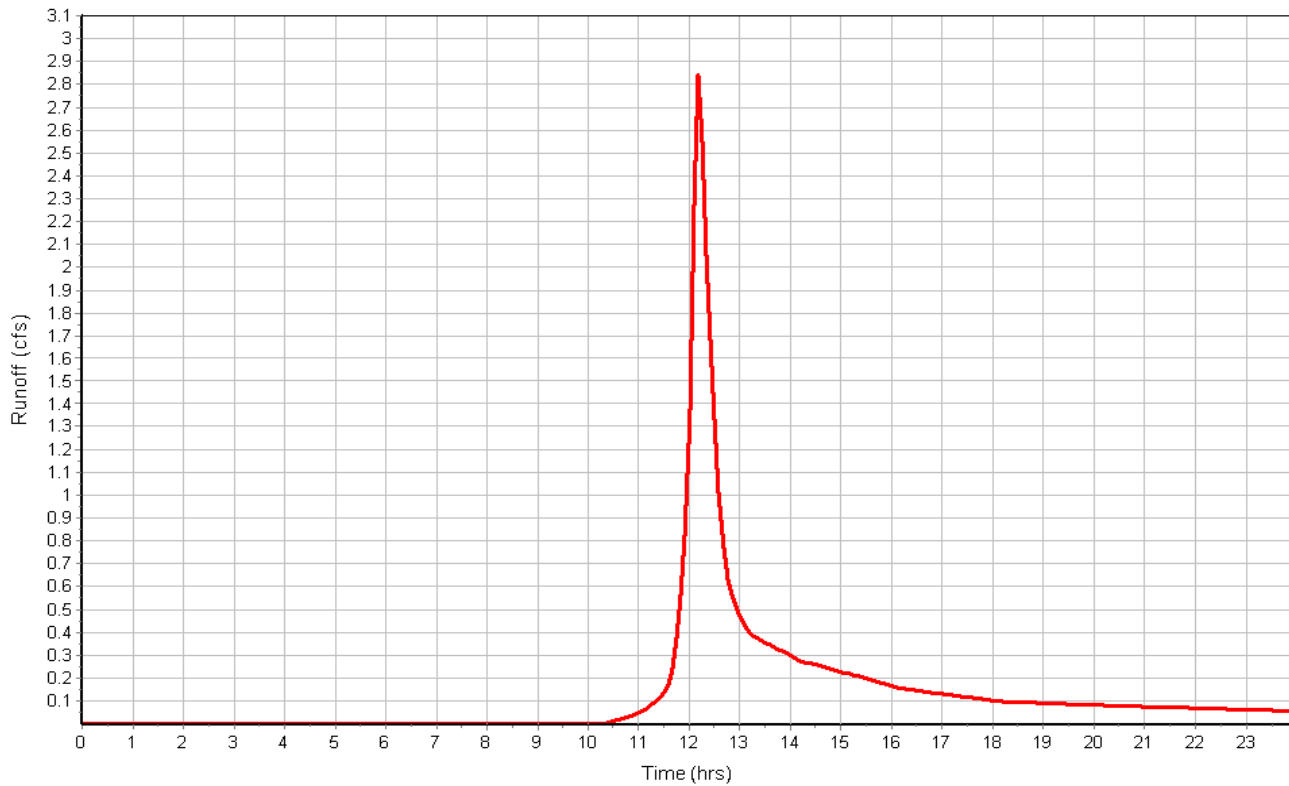

Junction Input

Element ID	Invert Elevation (ft)	Ground/Rim (Max) Elevation (ft)
CB1	305.30	310.33
CB2	312.00	316.00
END-SECTION-C1	308.00	6.00
END-SECTION-C2	308.00	6.00
OUTLET-STR-A2	305.60	312.00
OUTLET-STR-C1	308.10	312.00
OUTLET-STR-C2	308.10	312.00

Junction Results

Element ID	Peak Inflow (cfs)	Max HGL Elevation Attained (ft)	Max HGL Depth Attained (ft)	Min Freeboard Attained (ft)	Average HGL Elevation Attained (ft)	Time of Max HGL Occurrence (days hh:mm)
CB1	7.21	306.41	1.11	3.92	305.49	0 12:26
CB2	7.95	312.74	0.74	3.26	312.11	0 12:15
END-SECTION-C1	0.02	308.07	0.07	3.16	308.06	0 20:56
END-SECTION-C2	0.02	308.07	0.07	3.16	308.06	0 22:16
OUTLET-STR-A2	5.34	306.39	0.79	5.61	305.73	0 12:26
OUTLET-STR-C1	0.02	308.17	0.07	3.83	308.16	0 20:56
OUTLET-STR-C2	0.02	308.17	0.07	3.83	308.16	0 22:15

Pipe Input

Element ID	Length (ft)	Inlet Invert Elevation (ft)	Outlet Invert Elevation (ft)	Average Pipe Slope (%)	Pipe Shape	Pipe Diameter or Height (in)	Pipe Width (in)	Manning's Roughness
CULV-A	98.00	305.30	305.12	0.1800	CIRCULAR	36.000	36.000	0.0150
CULV-A2-1	104.00	312.00	310.00	1.9200	CIRCULAR	24.000	24.000	0.0150
CULV-A2-2	43.00	305.60	305.30	0.7000	CIRCULAR	24.000	24.000	0.0150
CULV-C1	30.00	308.10	308.00	0.3300	CIRCULAR	12.000	12.000	0.0130
CULV-C2	30.00	308.10	308.00	0.3300	CIRCULAR	12.000	12.000	0.0130

Pipe Results

Element ID	Peak Flow	Time of Peak Flow Occurrence	Design Flow Capacity	Peak Flow Velocity	Peak Flow Depth
	(cfs)	(days hh:mm)	(cfs)	(ft/sec)	(ft)
CULV-A	7.21	0 12:26	24.77	3.04	1.11
CULV-A2-1	7.91	0 12:15	27.19	7.52	0.74
CULV-A2-2	5.34	0 12:26	16.38	4.66	0.79
CULV-C1	0.02	0 20:56	2.06	0.81	0.07
CULV-C2	0.02	0 22:16	2.06	0.83	0.07

Storage Nodes

Storage Node : DETENTION-A

Input Data

Invert Elevation (ft) 309.50
Max (Rim) Elevation (ft) 312.00
Max (Rim) Offset (ft) 2.50
Initial Water Elevation (ft) 309.50
Initial Water Depth (ft) 0.00
Ponded Area (ft²) 0.00
Evaporation Loss 0.00

Storage Area Volume Curves

Storage Curve : Storage-08

Stage (ft)	Storage Area (ft ²)	Storage Volume (ft ³)
0	113	0.000
.5	15327	3860.00
1.2	18183.	15588.50
1.5	18635	21111.20
2.5	22257	41557.20

Storage Area Volume Curves

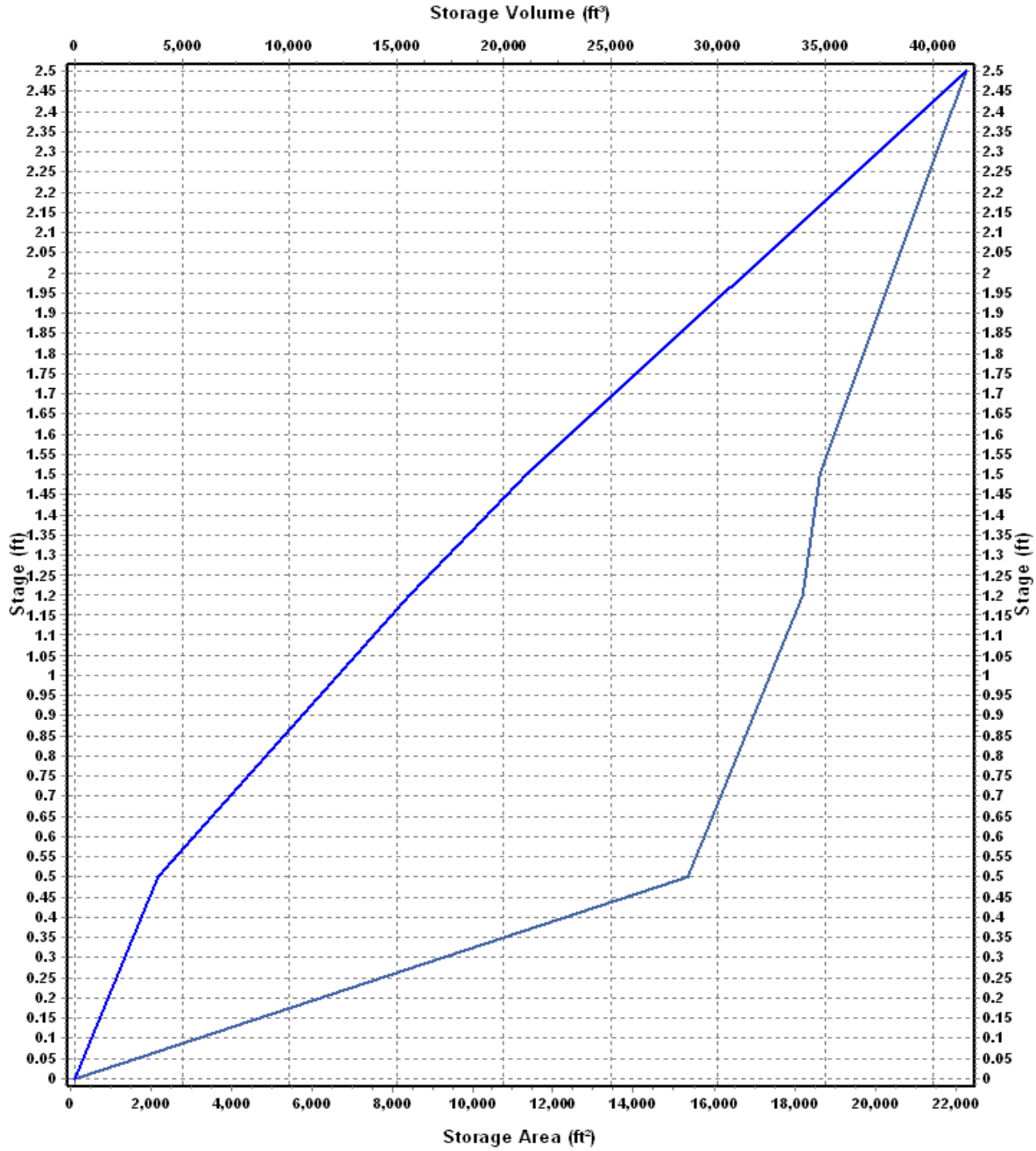

— Storage Area — Storage Volume

Storage Node : DETENTION-A (continued)

Outflow Orifices

Element ID	Orifice Type	Orifice Shape	Circular Orifice Diameter (in)	Rectangular Orifice Height (in)	Rectangular Orifice Width (in)	Orifice Invert Elevation (ft)	Orifice Coefficient
BEEHIVE-GRATE	Bottom	CIRCULAR	18.17			310.33	0.61
ORIF-DET-A	Side	Rectangular		4.00	36.00	309.50	0.63

Output Summary Results

Peak Inflow (cfs)	2.94
Peak Lateral Inflow (cfs)	2.94
Peak Outflow (cfs)	1.87
Peak Exfiltration Flow Rate (cfm)	0.00
Max HGL Elevation Attained (ft)	309.81
Max HGL Depth Attained (ft)	0.31
Average HGL Elevation Attained (ft)	309.54
Average HGL Depth Attained (ft)	0.04
Time of Max HGL Occurrence (days hh:mm)	0 12:25
Total Exfiltration Volume (1000-ft ³)	0.000
Total Flooded Volume (ac-in)	0
Total Time Flooded (min)	0
Total Retention Time (sec)	0.00

Storage Node : FILTER-A2

Input Data

Invert Elevation (ft)	308.00
Max (Rim) Elevation (ft)	312.00
Max (Rim) Offset (ft)	4.00
Initial Water Elevation (ft)	309.00
Initial Water Depth (ft)	1.00
Ponded Area (ft ²)	0.00
Evaporation Loss	0.00

Storage Area Volume Curves

Storage Curve : Storage-05

Stage (ft)	Storage Area (ft ²)	Storage Volume (ft ³)
0	2178	0.000
1	5898	4038.00
2	7084	10529.00
3	8421	18281.50
4	9818	27401.00

Storage Area Volume Curves

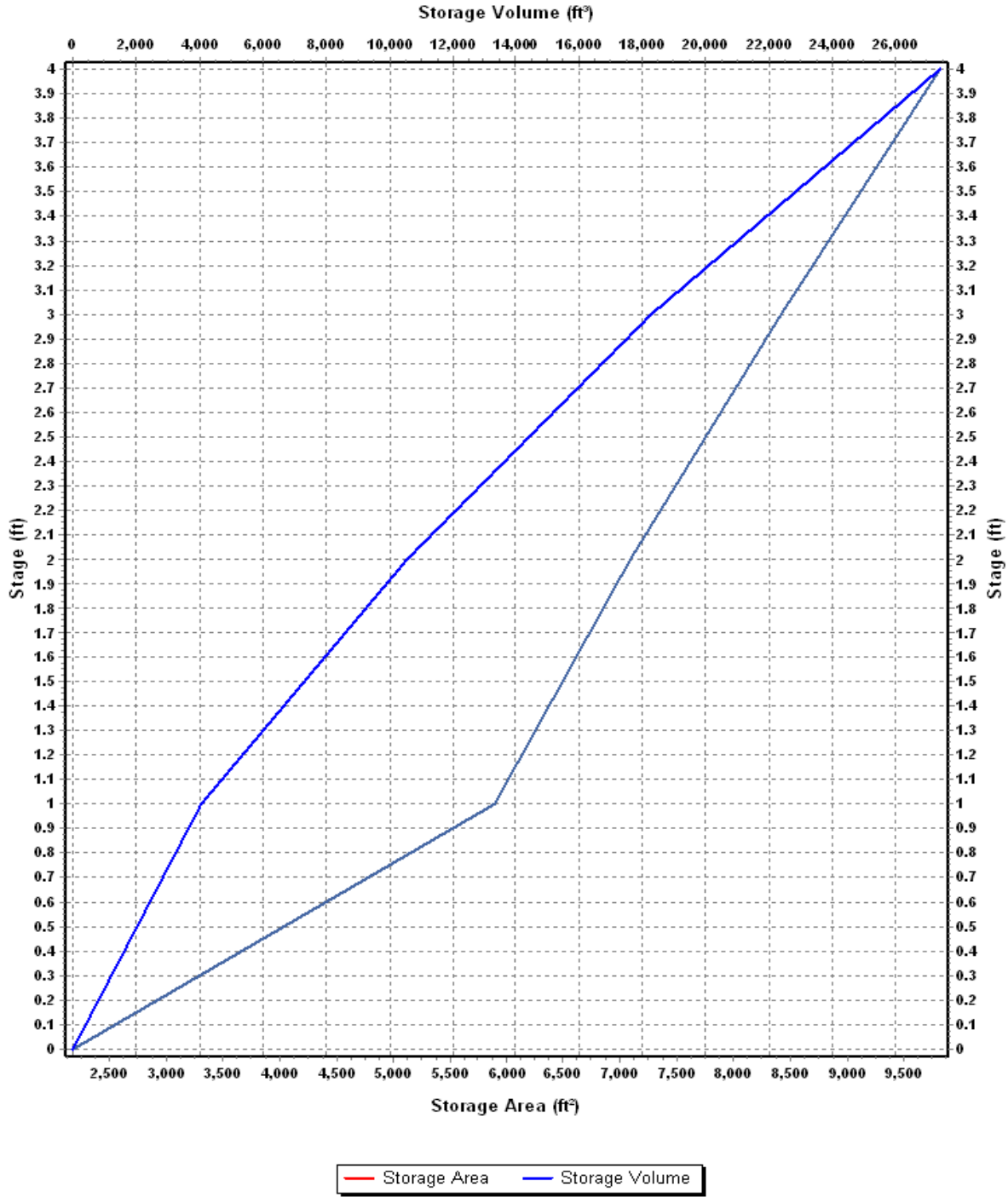

Storage Node : FILTER-A2 (continued)

Outflow Weirs

Element ID	Weir Type	Crest Elevation (ft)	Length (ft)	Weir Total Height (ft)	Discharge Coefficient
SPILLWAY-A2	Trapezoidal	310.70	55.00	1.30	3.10

Outflow Orifices

Element ID	Orifice Type	Orifice Shape	Circular Orifice Diameter (in)	Rectangular Orifice Height (in)	Rectangular Orifice Width (in)	Orifice Invert Elevation (ft)	Orifice Coefficient
ORIF-A2	Side	Rectangular		6.00	35.00	309.00	0.63

Output Summary Results

Peak Inflow (cfs)	7.91
Peak Lateral Inflow (cfs)	0.00
Peak Outflow (cfs)	5.34
Peak Exfiltration Flow Rate (cfm)	0.00
Max HGL Elevation Attained (ft)	309.78
Max HGL Depth Attained (ft)	1.78
Average HGL Elevation Attained (ft)	309.08
Average HGL Depth Attained (ft)	1.08
Time of Max HGL Occurrence (days hh:mm)	0 12:26
Total Exfiltration Volume (1000-ft ³)	0.000
Total Flooded Volume (ac-in)	0
Total Time Flooded (min)	0
Total Retention Time (sec)	0.00

Storage Node : WETLAND-C1

Input Data

Invert Elevation (ft)	308.77
Max (Rim) Elevation (ft)	312.00
Max (Rim) Offset (ft)	3.23
Initial Water Elevation (ft)	309.33
Initial Water Depth (ft)	0.56
Ponded Area (ft ²)	0.00
Evaporation Loss	0.00

Storage Area Volume Curves

Storage Curve : Storage-09

Stage (ft)	Storage Area (ft ²)	Storage Volume (ft ³)
0	2183	0.000
.57	2815	1424.43
1.33	3441	3801.71
2.33	4347	7695.71
3.33	5324	12531.21

Storage Area Volume Curves

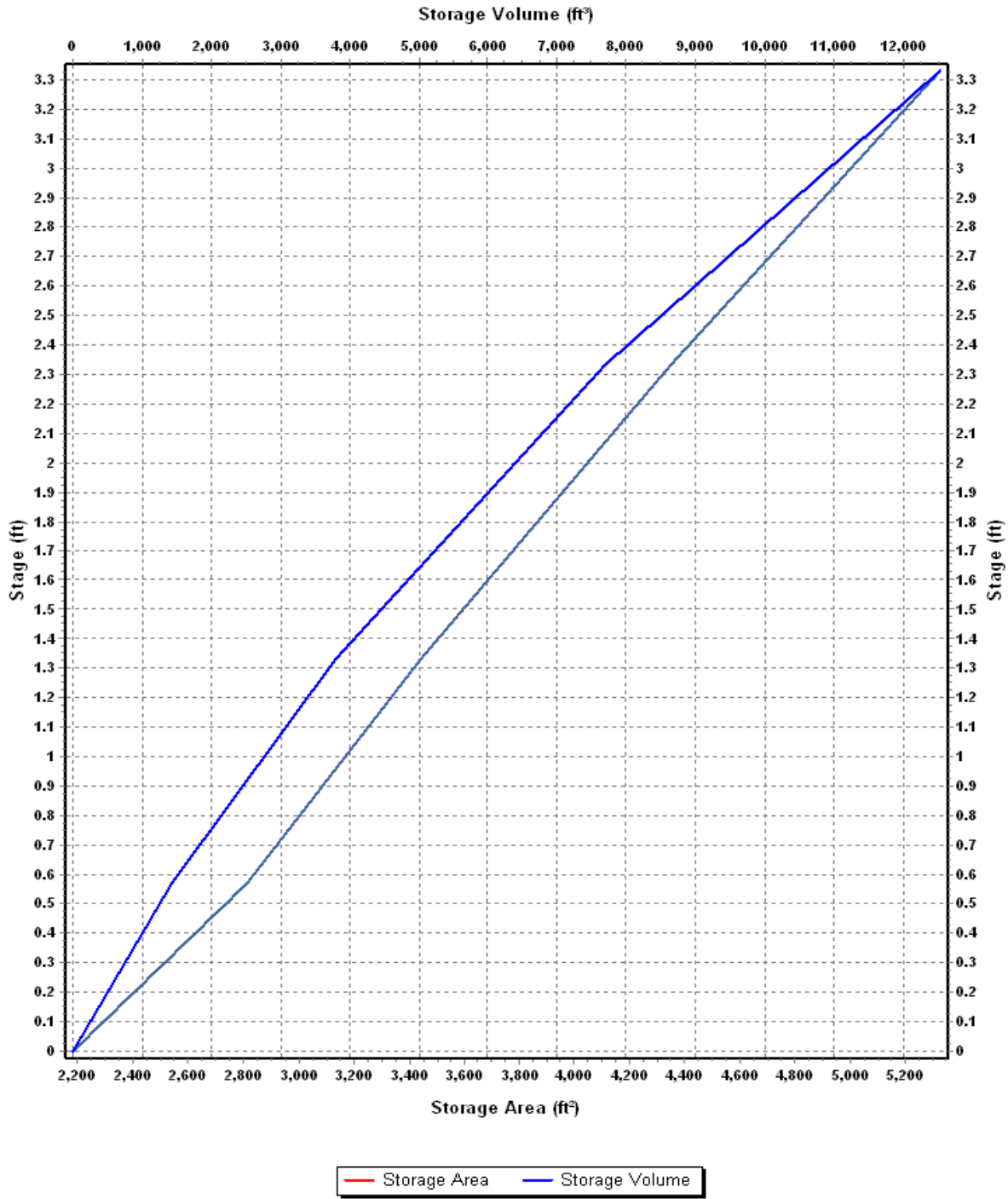

Storage Node : WETLAND-C1 (continued)

Outflow Weirs

Element ID	Weir Type	Crest Elevation (ft)	Length (ft)	Weir Total Height (ft)	Discharge Coefficient
SPILLWAY-C1	Trapezoidal	310.70	10.00	1.30	3.33

Outflow Orifices

Element ID	Orifice Type	Orifice Shape	Circular Orifice Diameter (in)	Rectangular Orifice Height (in)	Rectangular Orifice Width (in)	Orifice Invert Elevation (ft)	Orifice Coefficient
ORIF-C1	Side	CIRCULAR	0.83			308.10	0.61

Output Summary Results

Peak Inflow (cfs)	0.77
Peak Lateral Inflow (cfs)	0.77
Peak Outflow (cfs)	0.02
Peak Exfiltration Flow Rate (cfm)	0.00
Max HGL Elevation Attained (ft)	309.84
Max HGL Depth Attained (ft)	1.07
Average HGL Elevation Attained (ft)	309.51
Average HGL Depth Attained (ft)	0.74
Time of Max HGL Occurrence (days hh:mm)	0 20:56
Total Exfiltration Volume (1000-ft ³)	0.000
Total Flooded Volume (ac-in)	0
Total Time Flooded (min)	0
Total Retention Time (sec)	0.00

Storage Node : WETLAND-C2

Input Data

Invert Elevation (ft)	308.77
Max (Rim) Elevation (ft)	312.00
Max (Rim) Offset (ft)	3.23
Initial Water Elevation (ft)	309.42
Initial Water Depth (ft)	0.65
Ponded Area (ft ²)	0.00
Evaporation Loss	0.00

Storage Area Volume Curves

Storage Curve : Storage-07

Stage (ft)	Storage Area (ft ²)	Storage Volume (ft ³)
0	2828	0.000
.57	3522	1809.75
1.23	5207	4690.32
2.33	7549	11706.12
3.33	8345	19653.12

Storage Area Volume Curves

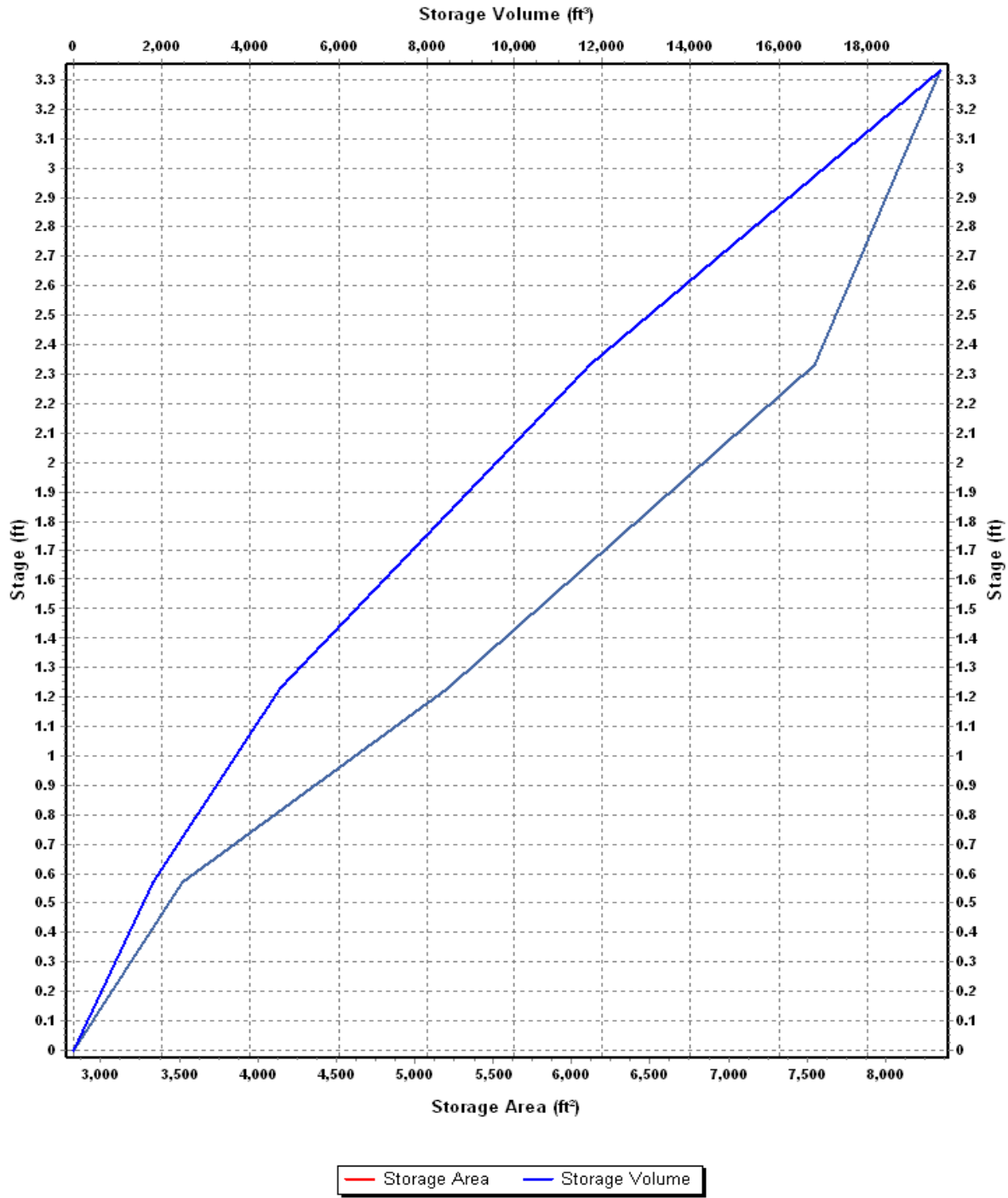

Storage Node : WETLAND-C2 (continued)

Outflow Weirs

Element ID	Weir Type	Crest Elevation (ft)	Length (ft)	Weir Total Height (ft)	Discharge Coefficient
SPILLWAY-C2	Trapezoidal	310.80	10.00	1.20	3.10

Outflow Orifices

Element ID	Orifice Type	Orifice Shape	Circular Orifice Diameter (in)	Rectangular Orifice Height (in)	Rectangular Orifice Width (in)	Orifice Invert Elevation (ft)	Orifice Coefficient
ORIF-C2A	Side	CIRCULAR	0.83			308.10	0.61

Output Summary Results

Peak Inflow (cfs)	0.74
Peak Lateral Inflow (cfs)	0.74
Peak Outflow (cfs)	0.02
Peak Exfiltration Flow Rate (cfm)	0.00
Max HGL Elevation Attained (ft)	309.97
Max HGL Depth Attained (ft)	1.2
Average HGL Elevation Attained (ft)	309.62
Average HGL Depth Attained (ft)	0.85
Time of Max HGL Occurrence (days hh:mm)	0 22:15
Total Exfiltration Volume (1000-ft ³)	0.000
Total Flooded Volume (ac-in)	0
Total Time Flooded (min)	0
Total Retention Time (sec)	0.00

Project Description

File Name Proposed Conditions 7-2-18.SPF

Project Options

Flow Units CFS
 Elevation Type Elevation
 Hydrology Method SCS TR-55
 Time of Concentration (TOC) Method SCS TR-55
 Link Routing Method Kinematic Wave
 Enable Overflow Ponding at Nodes YES
 Skip Steady State Analysis Time Periods NO

Analysis Options

Start Analysis On Jul 13, 2017 00:00:00
 End Analysis On Jul 14, 2017 00:00:00
 Start Reporting On Jul 13, 2017 00:00:00
 Antecedent Dry Days 0 days
 Runoff (Dry Weather) Time Step 0 01:00:00 days hh:mm:ss
 Runoff (Wet Weather) Time Step 0 00:05:00 days hh:mm:ss
 Reporting Time Step 0 00:05:00 days hh:mm:ss
 Routing Time Step 30 seconds

Number of Elements

	Qty
Rain Gages	1
Subbasins.....	9
Nodes.....	16
<i>Junctions</i>	7
<i>Outfalls</i>	5
<i>Flow Diversions</i>	0
<i>Inlets</i>	0
<i>Storage Nodes</i>	4
Links.....	15
<i>Channels</i>	2
<i>Pipes</i>	5
<i>Pumps</i>	0
<i>Orifices</i>	5
<i>Weirs</i>	3
<i>Outlets</i>	0
Pollutants	0
Land Uses	0

Rainfall Details

SN	Rain Gage ID	Data Source	Data Source ID	Rainfall Type	Rain Units	State	County	Return Period (years)	Rainfall Depth (inches)	Rainfall Distribution
1	Rain Gage-01	Time Series	TS-10	Cumulative	inches	Maine	Androscoggin	10	4.55	SCS Type III 24-hr

Subbasin Summary

Subbasin ID	Area (ac)	Weighted Curve Number	Total Rainfall (in)	Total Runoff (in)	Total Runoff Volume (ac-in)	Peak Runoff (cfs)	Time of Concentration (days hh:mm:ss)
A1	12.28	73.16	4.55	1.95	23.90	12.43	0 00:49:44
A2	6.41	81.47	4.55	2.63	16.88	15.32	0 00:12:48
A3	4.01	71.75	4.55	1.84	7.37	7.15	0 00:09:08
B	5.14	75.65	4.55	2.14	11.01	8.01	0 00:24:28
C1-WETLAND	0.75	75.95	4.55	2.17	1.62	1.70	0 00:05:00
C2-WETLAND	0.73	82.63	4.55	2.74	2.00	1.40	0 00:27:24
C3-BYPASS	21.22	71.79	4.55	1.84	39.09	14.12	0 01:29:22
D	0.69	77.00	4.55	2.25	1.55	1.43	0 00:12:07
E	2.96	77.00	4.55	2.25	6.66	6.01	0 00:13:08

Node Summary

Element ID	Element Type	Invert Elevation
		(ft)
CB1	Junction	305.30
CB2	Junction	312.00
END-SECTION-C1	Junction	308.00
END-SECTION-C2	Junction	308.00
OUTLET-STR-A2	Junction	305.60
OUTLET-STR-C1	Junction	308.10
OUTLET-STR-C2	Junction	308.10
OUT-A	Outfall	298.00
OUT-B	Outfall	310.00
OUT-C	Outfall	298.00
OUT-D	Outfall	338.00
OUT-E	Outfall	298.00
DETENTION-A	Storage Node	309.50
FILTER-A2	Storage Node	308.00
WETLAND-C1	Storage Node	308.77
WETLAND-C2	Storage Node	308.77

Link Summary

Element ID	Element Type	From (Inlet) Node	To (Outlet) Node	Length (ft)	Inlet Invert Elevation (ft)	Outlet Invert Elevation (ft)	Average Slope (%)	Diameter or Height (in)	Manning's Roughness	Peak Flow (cfs)	Design Flow Capacity (cfs)	Peak Flow Velocity (ft/sec)	Peak Flow Depth (ft)
CULV-A	Pipe	CB1	OUT-A	98.00	305.30	305.12	0.1800	36.000	0.0150	11.78	24.77	3.46	1.46
CULV-A2-1	Pipe	CB2	FILTER-A2	104.00	312.00	310.00	1.9200	24.000	0.0150	15.24	27.19	8.91	1.07
CULV-A2-2	Pipe	OUTLET-STR-A2	CB1	43.00	305.60	305.30	0.7000	24.000	0.0150	8.54	16.38	5.27	1.03
CULV-C1	Pipe	OUTLET-STR-C1	END-SECTION-C1	30.00	308.10	308.00	0.3300	12.000	0.0130	0.02	2.06	0.89	0.08
CULV-C2	Pipe	OUTLET-STR-C2	END-SECTION-C2	30.00	308.10	308.00	0.3300	12.000	0.0130	0.02	2.06	0.88	0.08
WETLAND-CHANNEL-C1	Channel	END-SECTION-C1	OUT-C	2050.00	308.00	298.00	0.4900	6.000	0.0320	0.02	101.48	0.00	0.00
WETLAND-CHANNEL-C2	Channel	END-SECTION-C2	OUT-C	1712.00	308.00	298.00	0.5800	6.000	0.0320	0.02	111.05	0.00	0.00
BEEHIVE-GRATE	Orifice	DETENTION-A	CB1		309.50	305.30		18.167		0.00			
ORIF-A2	Orifice	FILTER-A2	OUTLET-STR-A2		308.00	305.60		6.000		8.54			
ORIF-C1	Orifice	WETLAND-C1	OUTLET-STR-C1		308.77	308.10		0.830		0.02			
ORIF-C2A	Orifice	WETLAND-C2	OUTLET-STR-C2		308.77	308.10		0.830		0.02			
ORIF-DET-A	Orifice	DETENTION-A	CB1		309.50	305.30		4.000		3.24			
SPILLWAY-A2	Weir	FILTER-A2	DETENTION-A		308.00	309.50				0.00			
SPILLWAY-C1	Weir	WETLAND-C1	END-SECTION-C1		308.77	308.00				0.00			
SPILLWAY-C2	Weir	WETLAND-C2	END-SECTION-C2		308.77	308.00				0.00			

Subbasin Hydrology

Subbasin : A1

Input Data

Area (ac) 12.28
Weighted Curve Number 73.16
Rain Gage ID Rain Gage-01

Composite Curve Number

Soil/Surface Description	Area (acres)	Soil Group	Curve Number
Woods, Good	4.58	D	77.00
> 75% grass cover, Good	0.68	C	74.00
Woods, Good	6.62	C	70.00
> 75% grass cover, Good	0.40	D	80.00
Composite Area & Weighted CN	12.28		73.16

Time of Concentration

TOC Method : SCS TR-55

Sheet Flow Equation :

$$T_c = (0.007 * ((n * L_f)^{0.8})) / ((P^{0.5}) * (S_f^{0.4}))$$

Where :

T_c = Time of Concentration (hr)
n = Manning's roughness
L_f = Flow Length (ft)
P = 2 yr, 24 hr Rainfall (inches)
S_f = Slope (ft/ft)

Shallow Concentrated Flow Equation :

V = 16.1345 * (S_f^{0.5}) (unpaved surface)
V = 20.3282 * (S_f^{0.5}) (paved surface)
V = 15.0 * (S_f^{0.5}) (grassed waterway surface)
V = 10.0 * (S_f^{0.5}) (nearly bare & untilled surface)
V = 9.0 * (S_f^{0.5}) (cultivated straight rows surface)
V = 7.0 * (S_f^{0.5}) (short grass pasture surface)
V = 5.0 * (S_f^{0.5}) (woodland surface)
V = 2.5 * (S_f^{0.5}) (forest w/heavy litter surface)
T_c = (L_f / V) / (3600 sec/hr)

Where:

T_c = Time of Concentration (hr)
L_f = Flow Length (ft)
V = Velocity (ft/sec)
S_f = Slope (ft/ft)

Channel Flow Equation :

$$V = (1.49 * (R^{2/3})) * (S_f^{0.5}) / n$$

$$R = A_q / W_p$$

$$T_c = (L_f / V) / (3600 \text{ sec/hr})$$

Where :

T_c = Time of Concentration (hr)
L_f = Flow Length (ft)
R = Hydraulic Radius (ft)
A_q = Flow Area (ft²)
W_p = Wetted Perimeter (ft)
V = Velocity (ft/sec)
S_f = Slope (ft/ft)
n = Manning's roughness

	Subarea	Subarea	Subarea
	A	B	C
Sheet Flow Computations			
Manning's Roughness :	.6	0.00	0.00
Flow Length (ft) :	100	0.00	0.00
Slope (%) :	2	0.00	0.00
2 yr, 24 hr Rainfall (in) :	3.00	0.00	0.00
Velocity (ft/sec) :	0.05	0.00	0.00
Computed Flow Time (min) :	30.68	0.00	0.00
	Subarea	Subarea	Subarea
	A	B	C
Shallow Concentrated Flow Computations			
Flow Length (ft) :	1510	0.00	0.00
Slope (%) :	.78	0.00	0.00
Surface Type :		Unpaved	Unpaved
Velocity (ft/sec) :	1.32	0.00	0.00
Computed Flow Time (min) :	19.07	0.00	0.00
Total TOC (min)	49.74		

Subbasin Runoff Results

Total Rainfall (in)	4.55
Total Runoff (in)	1.95
Peak Runoff (cfs)	12.43
Weighted Curve Number	73.16
Time of Concentration (days hh:mm:ss)	0 00:49:44

Subbasin : A1

Rainfall Intensity Graph

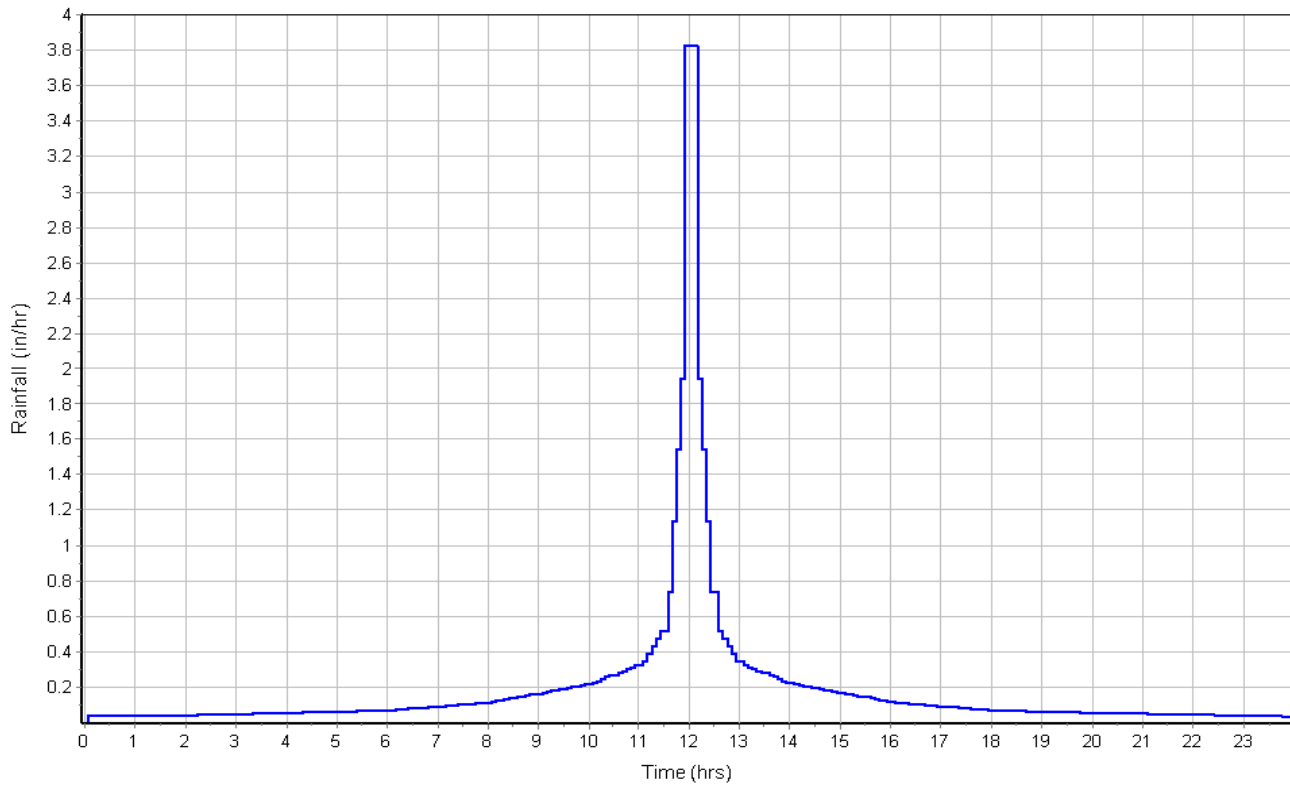

Runoff Hydrograph

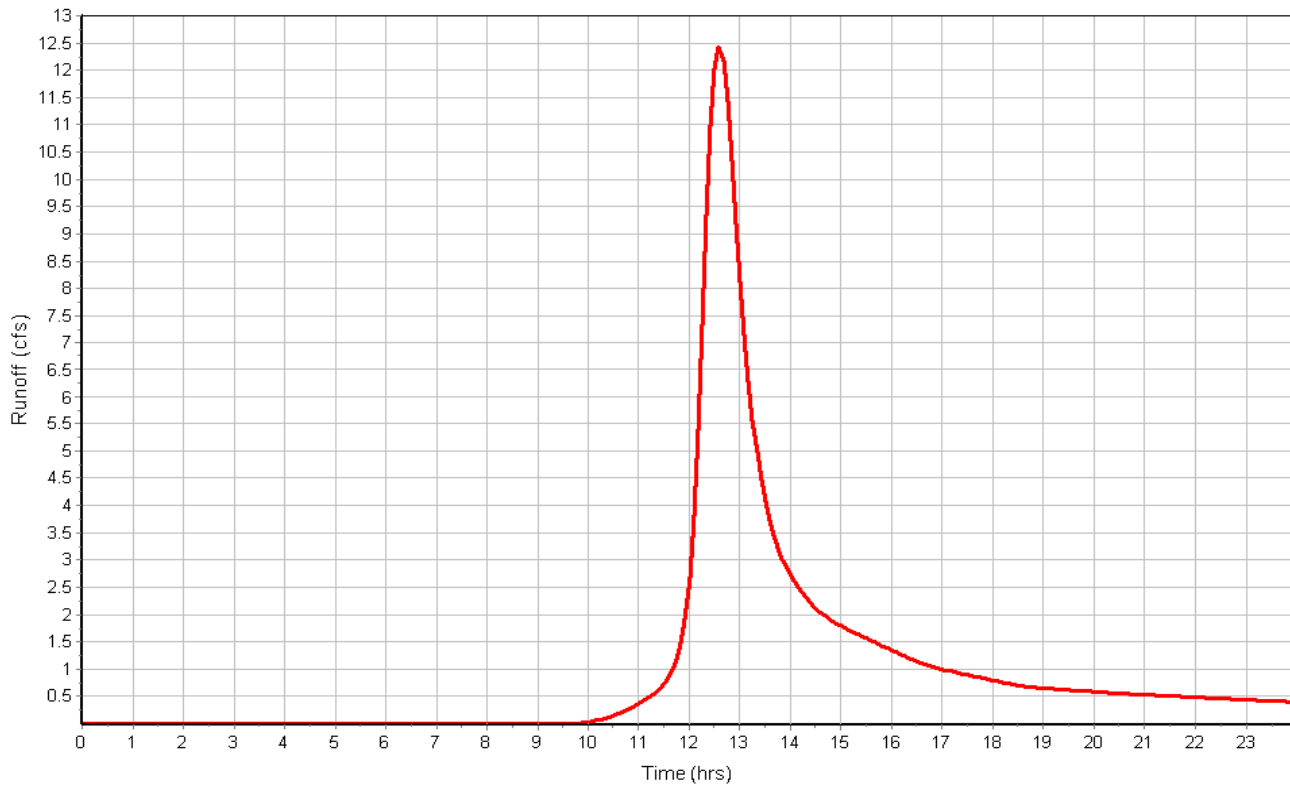

Subbasin : A2

Input Data

Area (ac) 6.41
 Weighted Curve Number 81.47
 Rain Gage ID Rain Gage-01

Composite Curve Number

Soil/Surface Description	Area (acres)	Soil Group	Curve Number
Woods, Good	0.13	D	77.00
Roofs	1.77	D	98.00
> 75% grass cover, Good	1.87	D	80.00
Stone_Pad	1.80	D	60.00
Gravel roads	0.17	D	91.00
Pavement	0.67	D	98.00
Composite Area & Weighted CN	6.41		81.47

Time of Concentration

	Subarea	Subarea	Subarea
	A	B	C
Sheet Flow Computations			
Manning's Roughness :	.4	0.00	0.00
Flow Length (ft) :	85	0.00	0.00
Slope (%) :	33.33	0.00	0.00
2 yr, 24 hr Rainfall (in) :	3.00	0.00	0.00
Velocity (ft/sec) :	0.22	0.00	0.00
Computed Flow Time (min) :	6.32	0.00	0.00
Channel Flow Computations			
Manning's Roughness :	.04	0.00	0.00
Flow Length (ft) :	1138	0.00	0.00
Channel Slope (%) :	1.4	0.00	0.00
Cross Section Area (ft ²) :	4.398	0.00	0.00
Wetted Perimeter (ft) :	8.12	0.00	0.00
Velocity (ft/sec) :	2.93	0.00	0.00
Computed Flow Time (min) :	6.48	0.00	0.00
Total TOC (min)	12.80		

Subbasin Runoff Results

Total Rainfall (in) 4.55
 Total Runoff (in) 2.63
 Peak Runoff (cfs) 15.32
 Weighted Curve Number 81.47
 Time of Concentration (days hh:mm:ss) 0 00:12:48

Subbasin : A2

Rainfall Intensity Graph

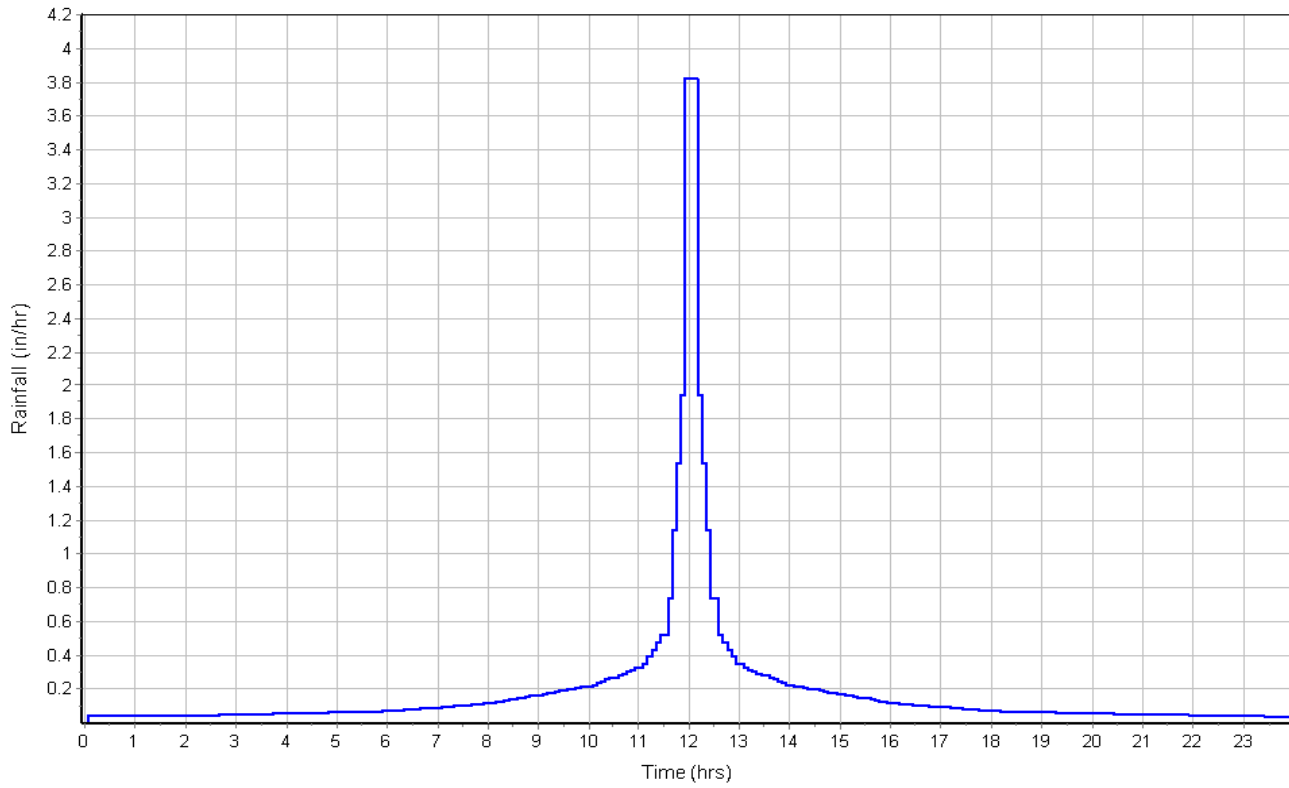

Runoff Hydrograph

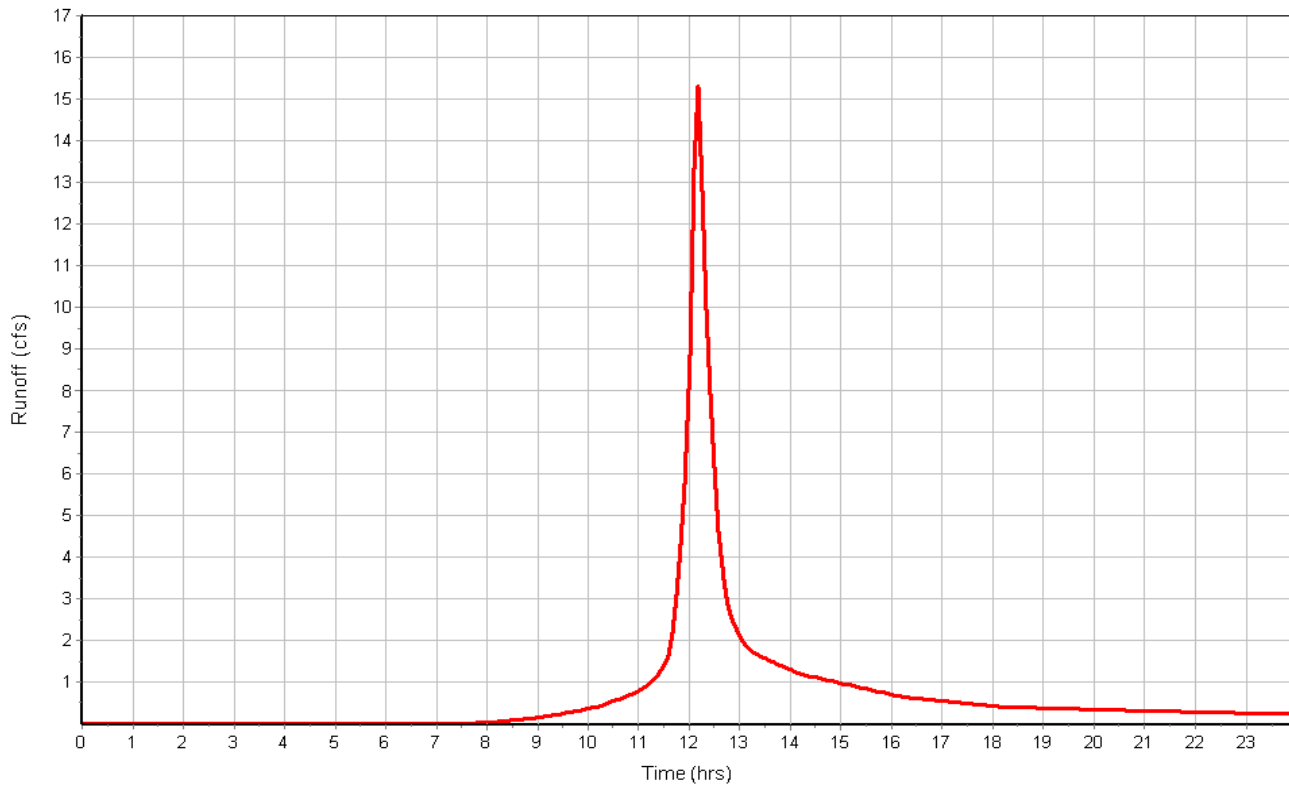

Subbasin : A3

Input Data

Area (ac) 4.01
 Weighted Curve Number 71.75
 Rain Gage ID Rain Gage-01

Composite Curve Number

Soil/Surface Description	Area (acres)	Soil Group	Curve Number
> 75% grass cover, Good	0.75	D	80.00
> 75% grass cover, Good	0.14	C	74.00
Stone_Pad	2.28	D	60.00
Roofs	0.19	D	98.00
Gravel roads	0.25	D	91.00
Pavement	0.35	D	98.00
Foundations	0.05	D	98.00
Composite Area & Weighted CN	4.01		71.75

Time of Concentration

Sheet Flow Computations	Subarea	Subarea	Subarea
	A	B	C
Manning's Roughness :	.01	0.00	0.00
Flow Length (ft) :	100	0.00	0.00
Slope (%) :	2	0.00	0.00
2 yr, 24 hr Rainfall (in) :	3.00	0.00	0.00
Velocity (ft/sec) :	1.44	0.00	0.00
Computed Flow Time (min) :	1.16	0.00	0.00

Shallow Concentrated Flow Computations	Subarea	Subarea	Subarea
	A	B	C
Flow Length (ft) :	548	25	200
Slope (%) :	2	33.33	1.5
Surface Type :	Unpaved		
Velocity (ft/sec) :	2.28	4.04	0.86
Computed Flow Time (min) :	4.01	0.10	3.88
Total TOC (min)9.14			

Subbasin Runoff Results

Total Rainfall (in) 4.55
 Total Runoff (in) 1.84
 Peak Runoff (cfs) 7.15
 Weighted Curve Number 71.75
 Time of Concentration (days hh:mm:ss) 0 00:09:08

Subbasin : A3

Rainfall Intensity Graph

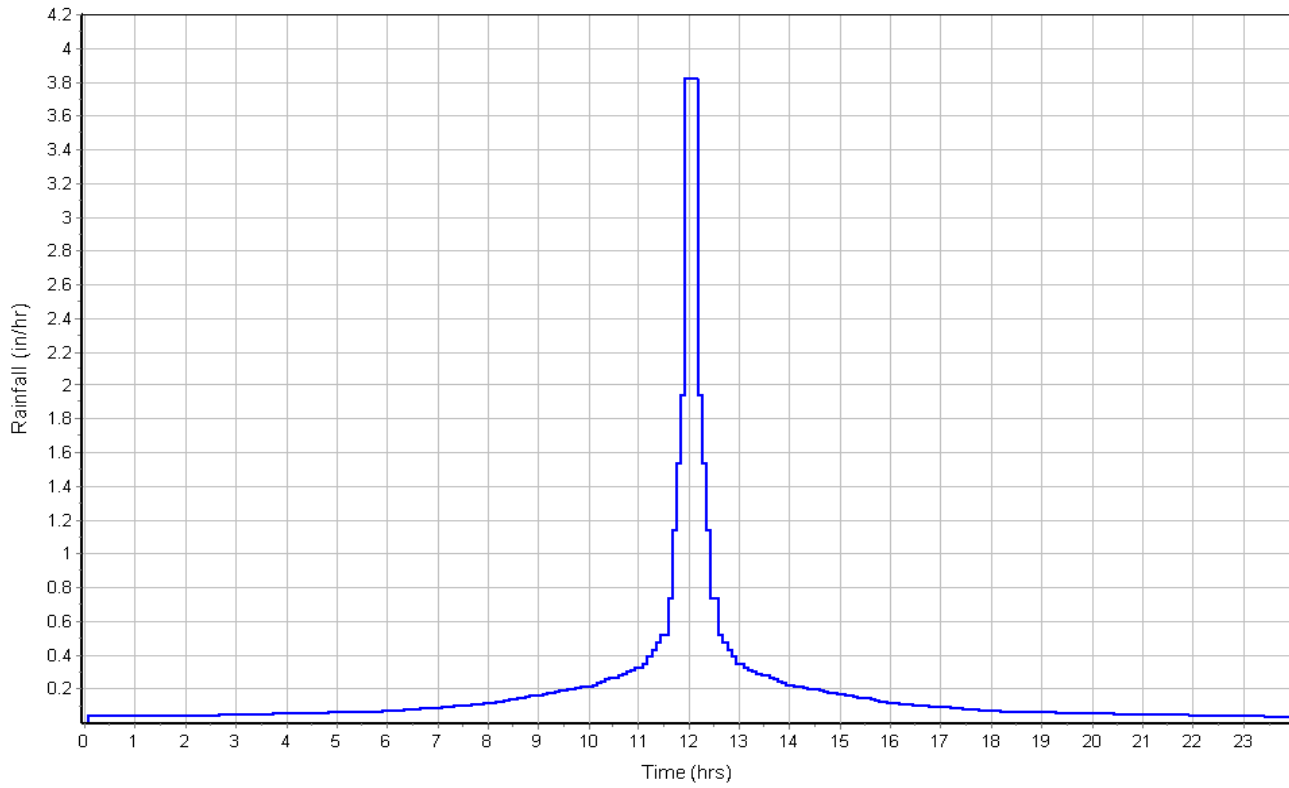

Runoff Hydrograph

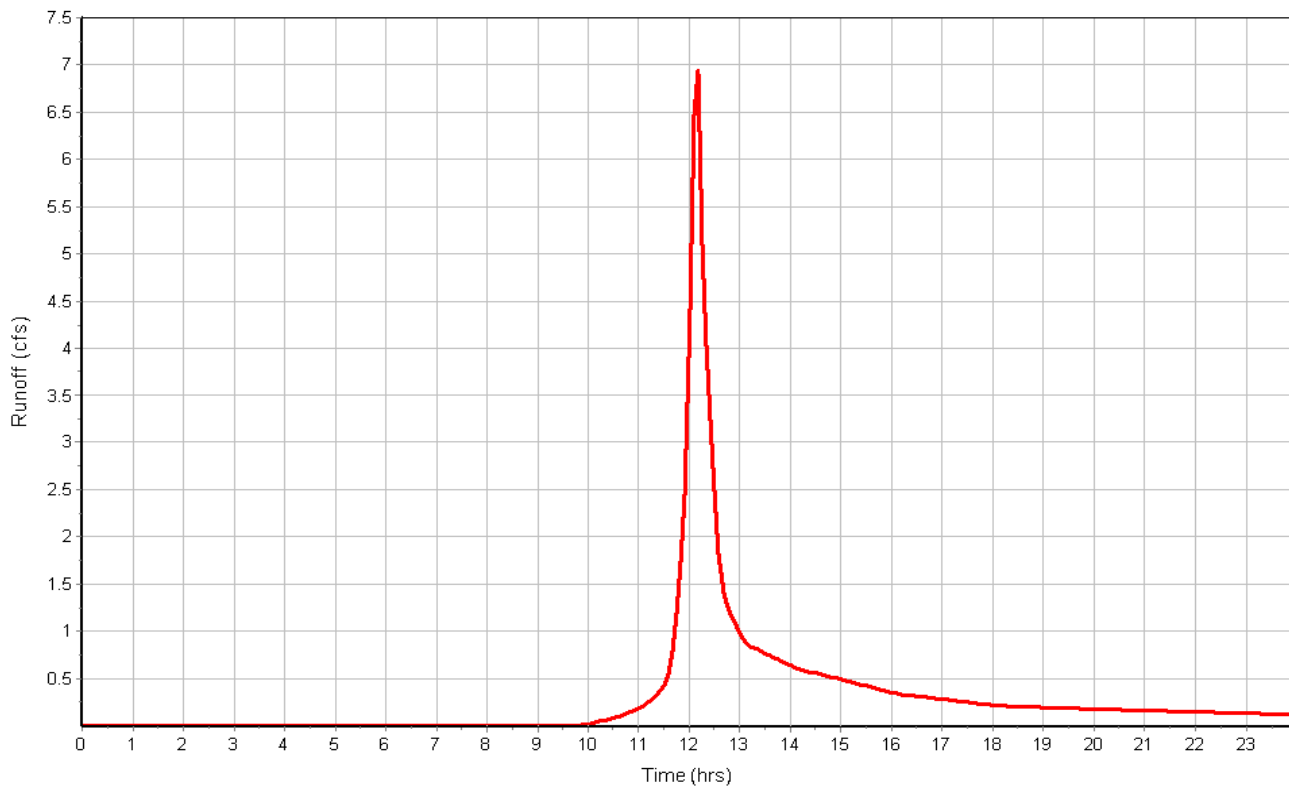

Subbasin : B

Input Data

Area (ac) 5.14
 Weighted Curve Number 75.65
 Rain Gage ID Rain Gage-01

Composite Curve Number

Soil/Surface Description	Area (acres)	Soil Group	Curve Number
Woods, Good	1.20	C	70.00
Woods, Good	3.45	D	77.00
> 75% grass cover, Good	0.49	D	80.00
Composite Area & Weighted CN	5.14		75.65

Time of Concentration

	Subarea A	Subarea B	Subarea C
Sheet Flow Computations			
Manning's Roughness :	.4	0.00	0.00
Flow Length (ft) :	90	0.00	0.00
Slope (%) :	33.33	0.00	0.00
2 yr, 24 hr Rainfall (in) :	3.00	0.00	0.00
Velocity (ft/sec) :	0.23	0.00	0.00
Computed Flow Time (min) :	6.62	0.00	0.00
Shallow Concentrated Flow Computations			
Flow Length (ft) :	368	0.00	0.00
Slope (%) :	1.63	0.00	0.00
Surface Type :		Unpaved	Unpaved
Velocity (ft/sec) :	1.92	0.00	0.00
Computed Flow Time (min) :	3.19	0.00	0.00
Channel Flow Computations			
Manning's Roughness :	.3	.3	0.00
Flow Length (ft) :	272	85	0.00
Channel Slope (%) :	1.4	16.7	0.00
Cross Section Area (ft²) :	3.287	1.367	0.00
Wetted Perimeter (ft) :	7.17	5.15	0.00
Velocity (ft/sec) :	0.35	0.84	0.00
Computed Flow Time (min) :	12.97	1.69	0.00
Total TOC (min)	24.48		

Subbasin Runoff Results

Total Rainfall (in) 4.55
 Total Runoff (in) 2.14
 Peak Runoff (cfs) 8.01
 Weighted Curve Number 75.65
 Time of Concentration (days hh:mm:ss) 0 00:24:29

Subbasin : B

Rainfall Intensity Graph

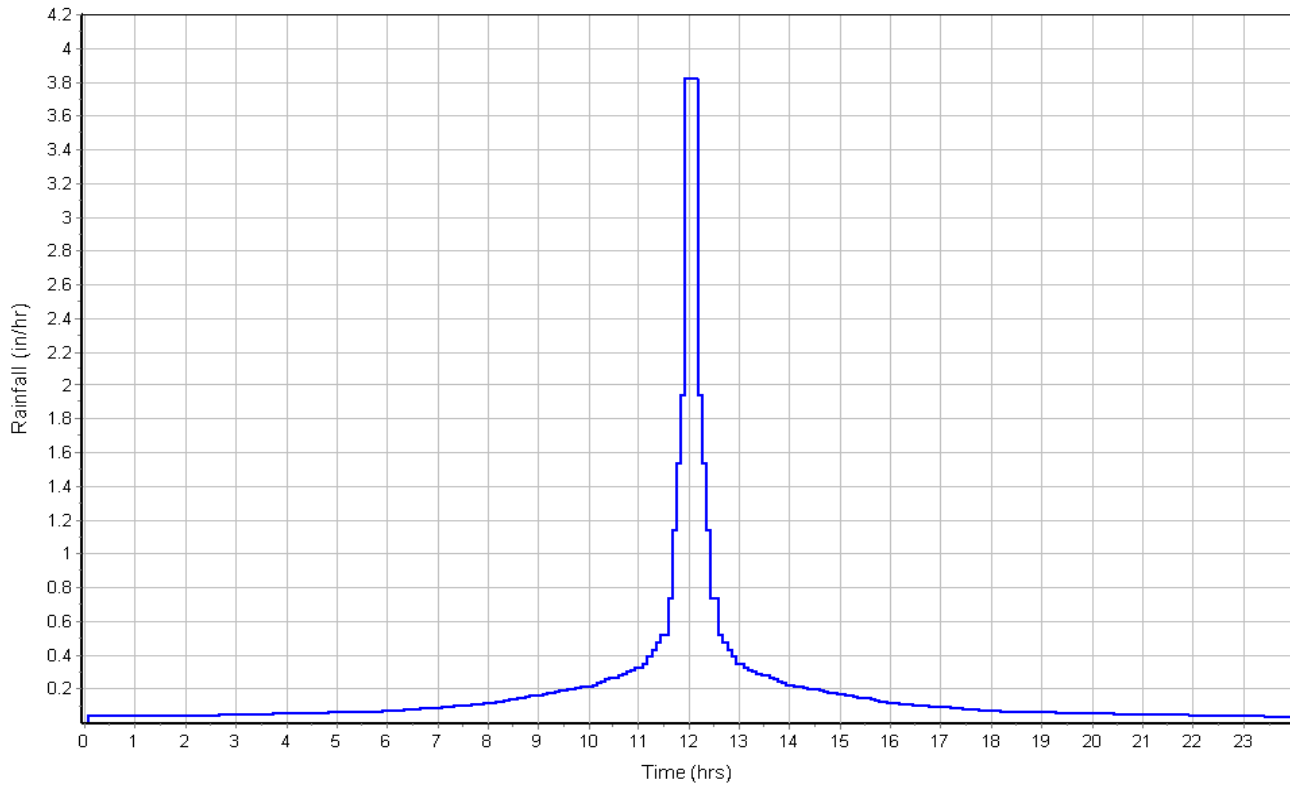

Runoff Hydrograph

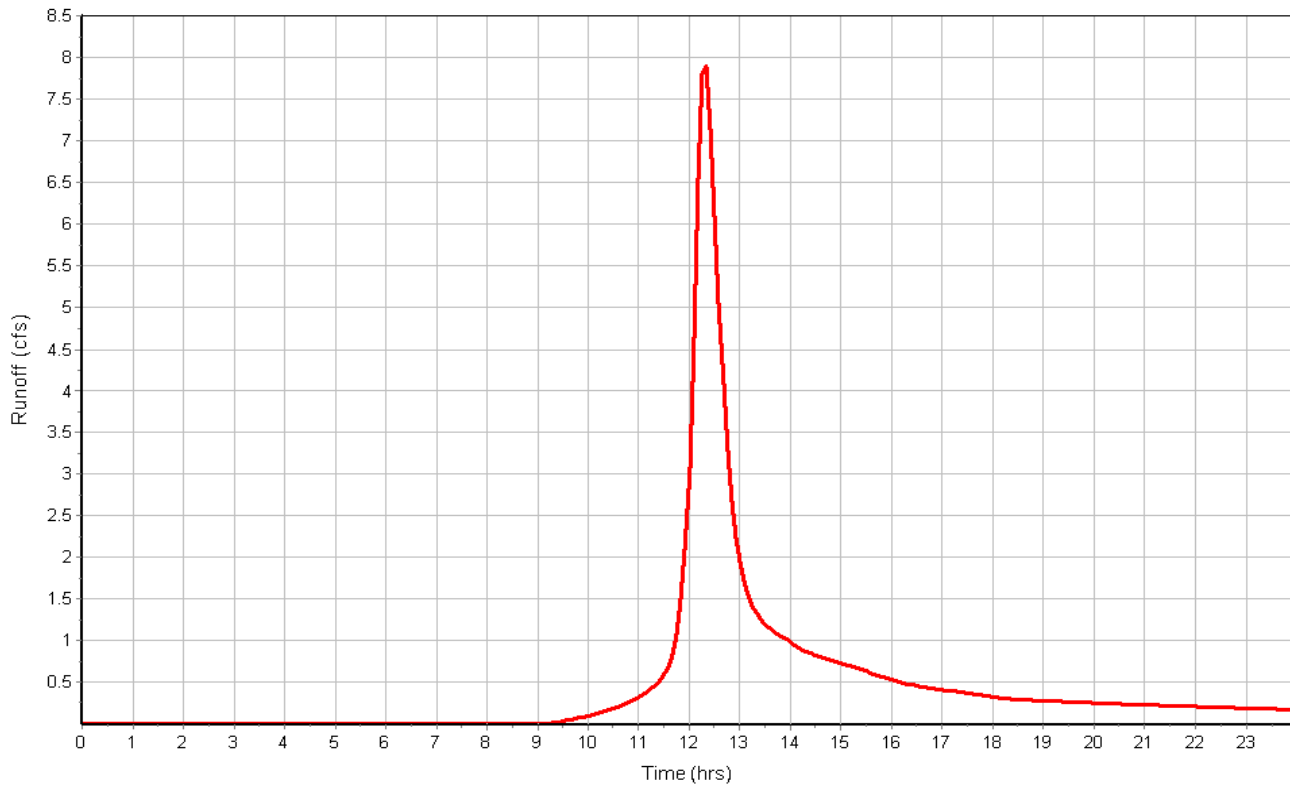

Subbasin : C1-WETLAND

Input Data

Area (ac) 0.75
Weighted Curve Number 75.95
Rain Gage ID Rain Gage-01

Composite Curve Number

Soil/Surface Description	Area (acres)	Soil Group	Curve Number
Woods, Good	0.12	D	77.00
> 75% grass cover, Good	0.04	A	39.00
> 75% grass cover, Good	0.05	D	80.00
> 75% grass cover, Good	0.34	C	74.00
Woods, Good	0.02	C	70.00
Gravel roads	0.04	A	76.00
Gravel roads	0.09	C	89.00
Gravel roads	0.05	D	91.00
Composite Area & Weighted CN	0.75		75.95

Time of Concentration

User-Defined TOC override (minutes): 5

Subbasin Runoff Results

Total Rainfall (in) 4.55
Total Runoff (in) 2.17
Peak Runoff (cfs) 1.70
Weighted Curve Number 75.95
Time of Concentration (days hh:mm:ss) 0 00:05:00

Subbasin : C1-WETLAND

Rainfall Intensity Graph

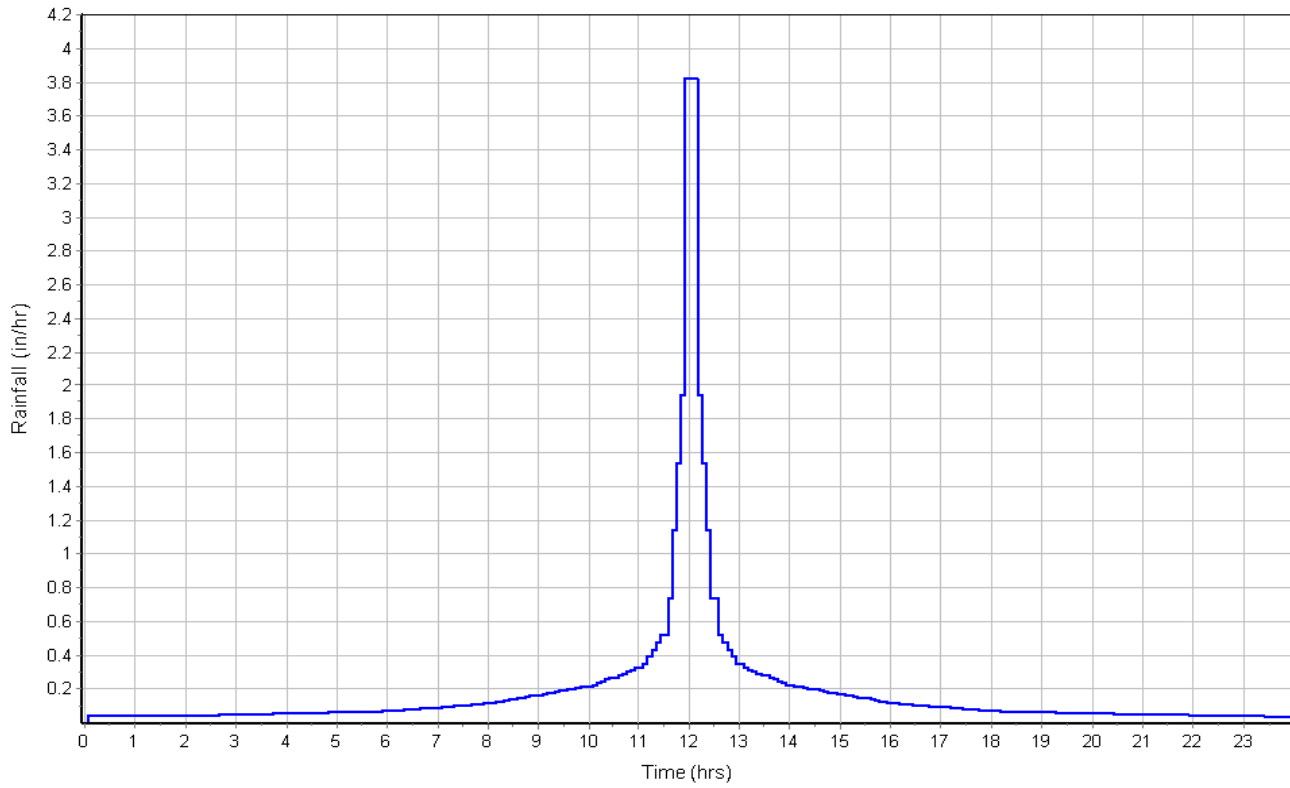

Runoff Hydrograph

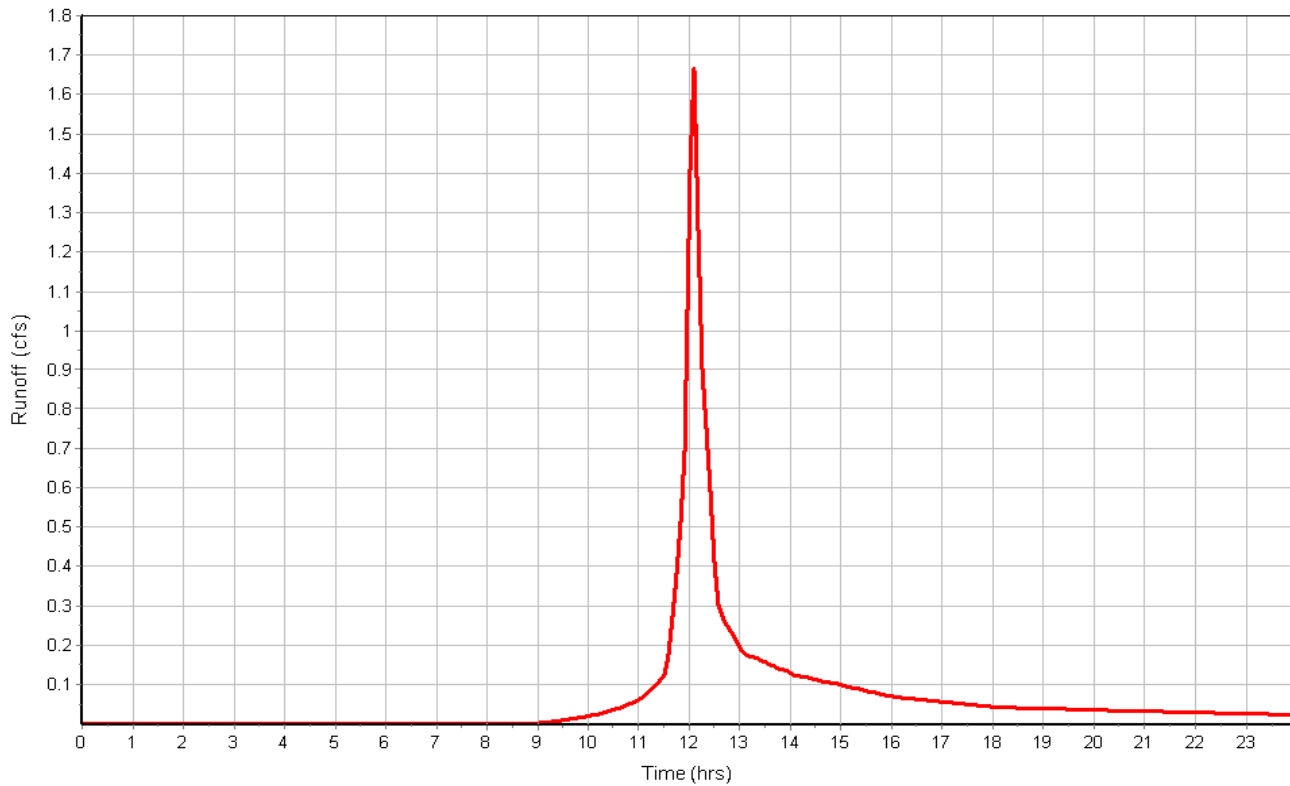

Subbasin : C2-WETLAND

Input Data

Area (ac) 0.73
 Weighted Curve Number 82.63
 Rain Gage ID Rain Gage-01

Composite Curve Number

Soil/Surface Description	Area (acres)	Soil Group	Curve Number
> 75% grass cover, Good	0.31	C	74.00
Gravel roads	0.42	C	89.00
Composite Area & Weighted CN	0.73		82.63

Time of Concentration

Sheet Flow Computations	Subarea	Subarea	Subarea
	A	B	C
Manning's Roughness :	.01	0.00	0.00
Flow Length (ft) :	44	0.00	0.00
Slope (%) :	2	0.00	0.00
2 yr, 24 hr Rainfall (in) :	3.00	0.00	0.00
Velocity (ft/sec) :	1.22	0.00	0.00
Computed Flow Time (min) :	0.60	0.00	0.00

Shallow Concentrated Flow Computations	Subarea	Subarea	Subarea
	A	B	C
Flow Length (ft) :	636	0.00	0.00
Slope (%) :	1.6	0.00	0.00
Surface Type :	Grassed waterway	Unpaved	Unpaved
Velocity (ft/sec) :	1.90	0.00	0.00
Computed Flow Time (min) :	5.58	0.00	0.00

Channel Flow Computations	Subarea	Subarea	Subarea
	A	B	C
Manning's Roughness :	.03	0.00	0.00
Flow Length (ft) :	2256	0.00	0.00
Channel Slope (%) :	.5	0.00	0.00
Cross Section Area (ft ²) :	2.475	0.00	0.00
Wetted Perimeter (ft) :	6.91	0.00	0.00
Velocity (ft/sec) :	1.77	0.00	0.00
Computed Flow Time (min) :	21.23	0.00	0.00
Total TOC (min)	27.41		

Subbasin Runoff Results

Total Rainfall (in) 4.55
 Total Runoff (in) 2.74
 Peak Runoff (cfs) 1.40
 Weighted Curve Number 82.63
 Time of Concentration (days hh:mm:ss) 0 00:27:25

Subbasin : C2-WETLAND

Rainfall Intensity Graph

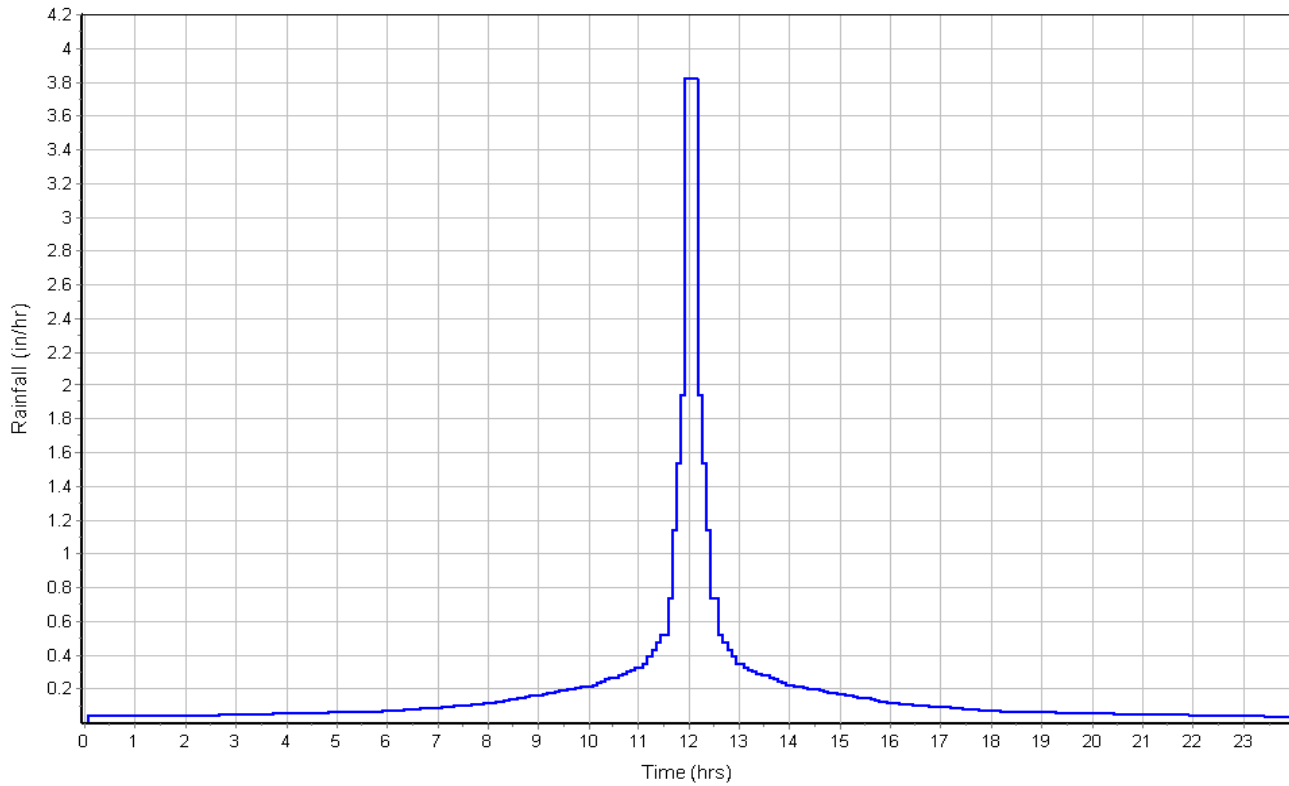

Runoff Hydrograph

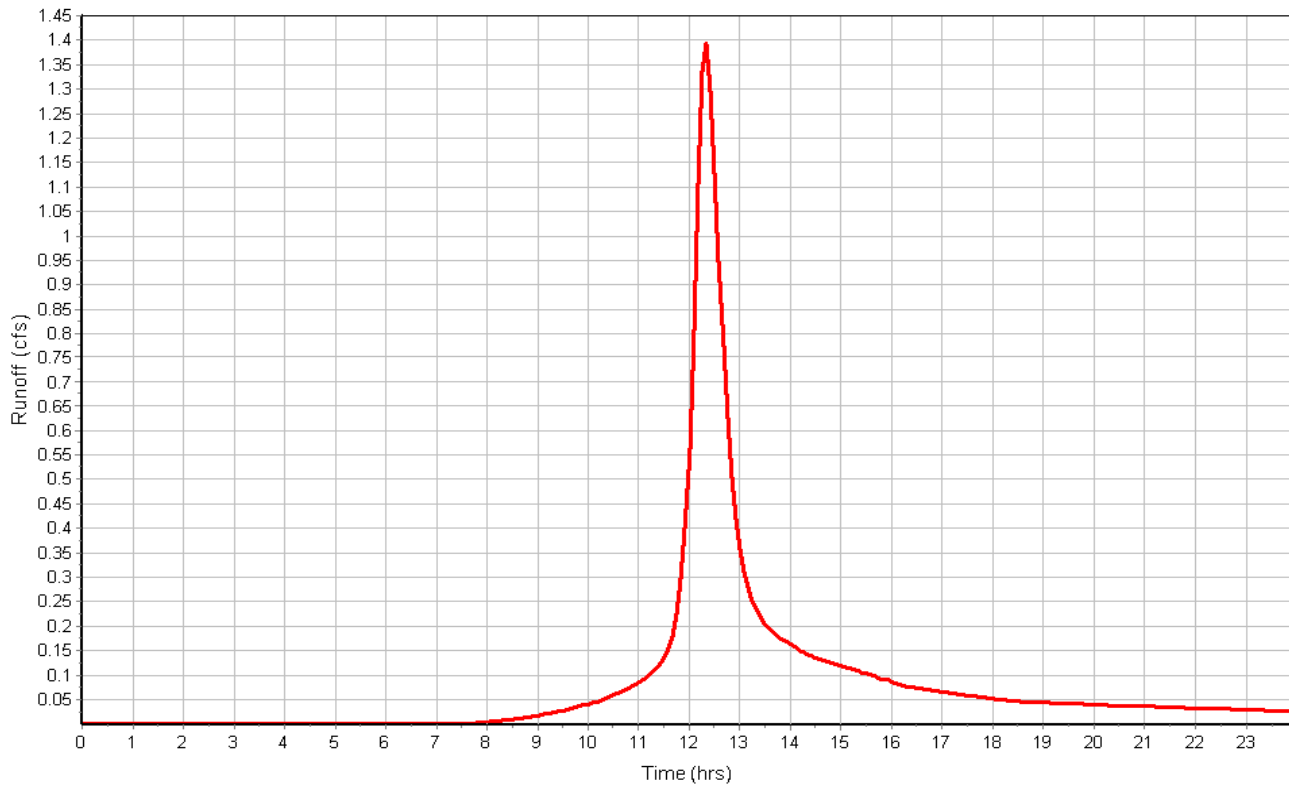

Subbasin : C3-BYPASS

Input Data

Area (ac) 21.22
 Weighted Curve Number 71.79
 Rain Gage ID Rain Gage-01

Composite Curve Number

Soil/Surface Description	Area (acres)	Soil Group	Curve Number
> 75% grass cover, Good	0.01	D	80.00
Woods, Good	12.33	C	70.00
Woods, Good	7.45	D	77.00
> 75% grass cover, Good	0.66	A	39.00
> 75% grass cover, Good	0.57	C	74.00
Gravel roads	0.20	C	89.00
Composite Area & Weighted CN	21.22		71.79

Time of Concentration

Sheet Flow Computations	Subarea	Subarea	Subarea
	A	B	C
Manning's Roughness :	.6	0.00	0.00
Flow Length (ft) :	100	0.00	0.00
Slope (%) :	.47	0.00	0.00
2 yr, 24 hr Rainfall (in) :	3.00	0.00	0.00
Velocity (ft/sec) :	0.03	0.00	0.00
Computed Flow Time (min) :	54.75	0.00	0.00

Shallow Concentrated Flow Computations	Subarea	Subarea	Subarea
	A	B	C
Flow Length (ft) :	2140	0.00	0.00
Slope (%) :	.47	0.00	0.00
Surface Type :	Grassed waterway	Unpaved	Unpaved
Velocity (ft/sec) :	1.03	0.00	0.00
Computed Flow Time (min) :	34.63	0.00	0.00
Total TOC (min)	89.38		

Subbasin Runoff Results

Total Rainfall (in) 4.55
 Total Runoff (in) 1.84
 Peak Runoff (cfs) 14.12
 Weighted Curve Number 71.79
 Time of Concentration (days hh:mm:ss) 0 01:29:23

Subbasin : C3-BYPASS

Rainfall Intensity Graph

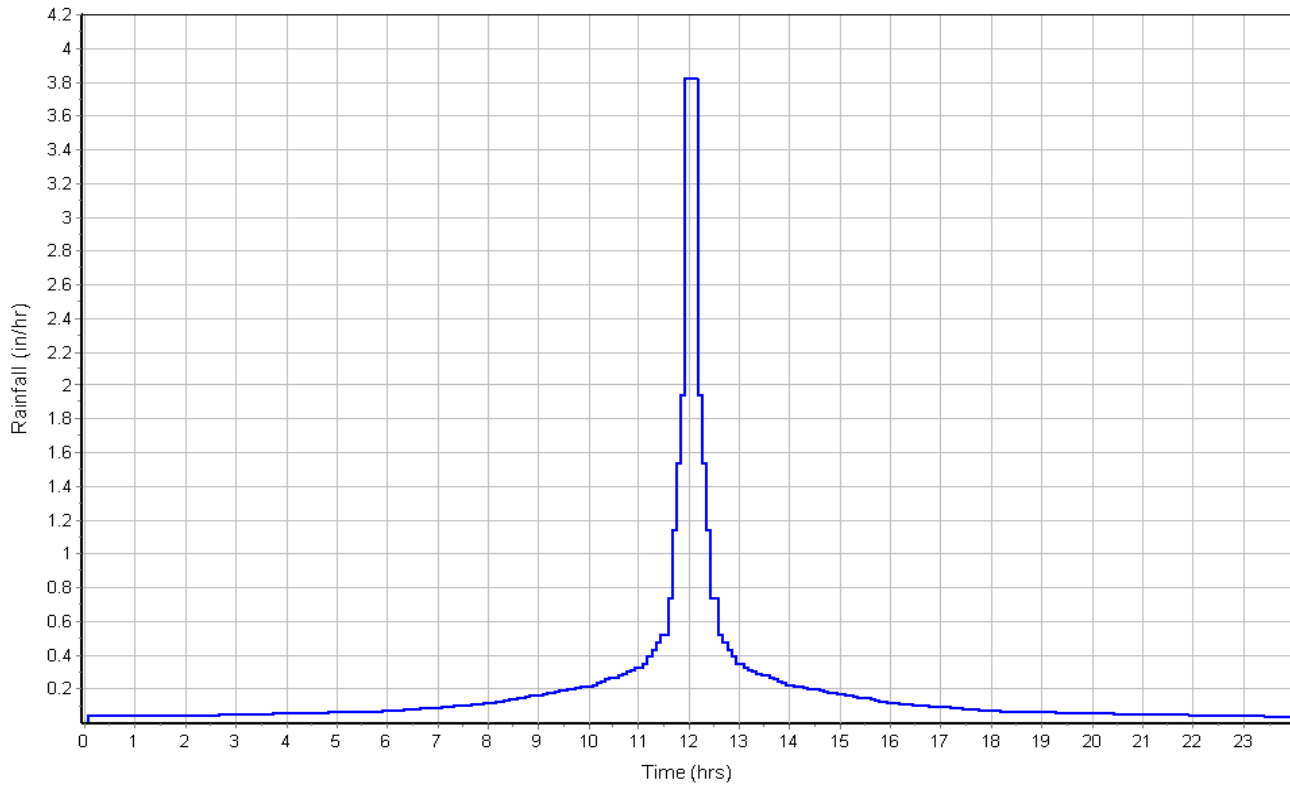

Runoff Hydrograph

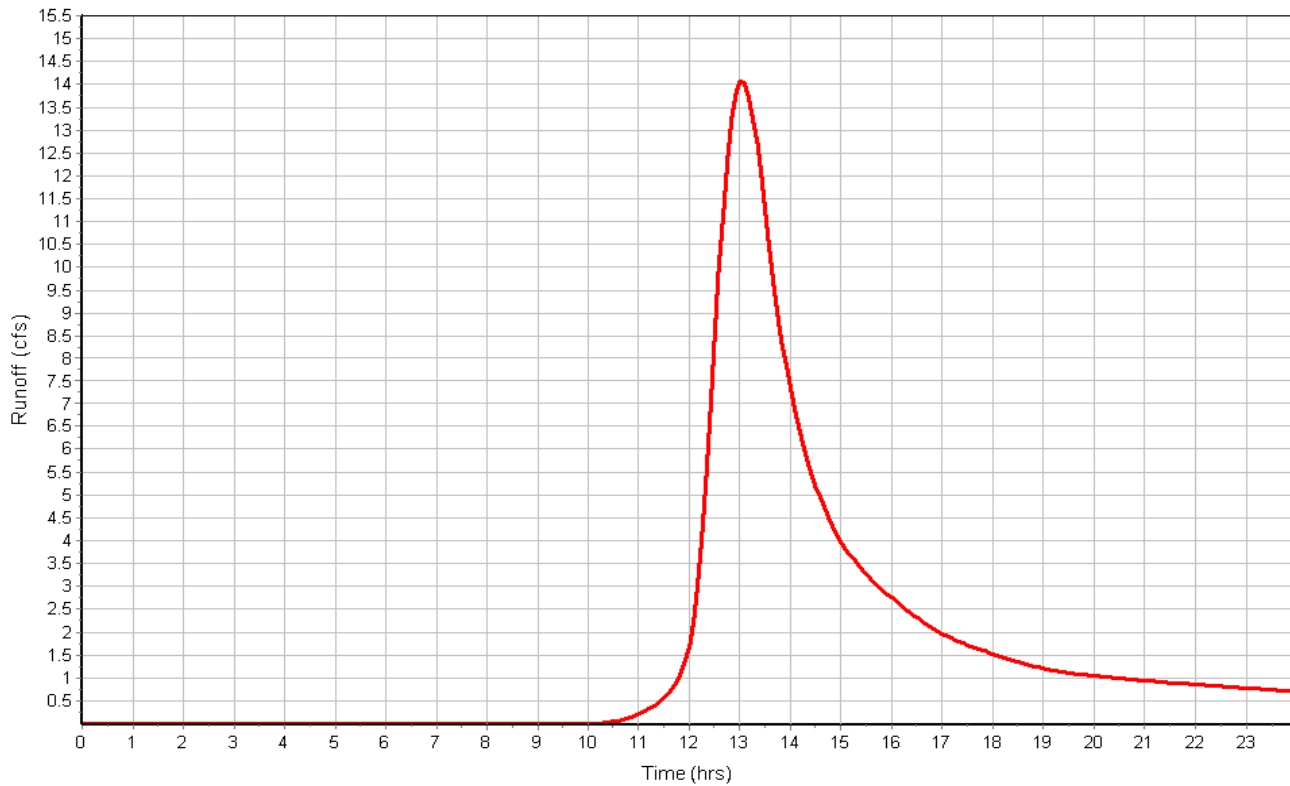

Subbasin : D

Input Data

Area (ac) 0.69
 Weighted Curve Number 77.00
 Rain Gage ID Rain Gage-01

Composite Curve Number

Soil/Surface Description	Area (acres)	Soil Group	Curve Number
Woods, Good	0.74	D	77.00
Composite Area & Weighted CN	0.74		77.00

Time of Concentration

Sheet Flow Computations	Subarea	Subarea	Subarea
	A	B	C
Manning's Roughness :	.6	0.00	0.00
Flow Length (ft) :	100	0.00	0.00
Slope (%) :	21	0.00	0.00
2 yr, 24 hr Rainfall (in) :	3.00	0.00	0.00
Velocity (ft/sec) :	0.14	0.00	0.00
Computed Flow Time (min) :	11.98	0.00	0.00

Shallow Concentrated Flow Computations	Subarea	Subarea	Subarea
	A	B	C
Flow Length (ft) :	16	0.00	0.00
Slope (%) :	14.5	0.00	0.00
Surface Type :	Woodland	Unpaved	Unpaved
Velocity (ft/sec) :	1.90	0.00	0.00
Computed Flow Time (min) :	0.14	0.00	0.00
Total TOC (min)	12.12		

Subbasin Runoff Results

Total Rainfall (in) 4.55
 Total Runoff (in) 2.25
 Peak Runoff (cfs) 1.43
 Weighted Curve Number 77.00
 Time of Concentration (days hh:mm:ss) 0 00:12:07

Subbasin : D

Rainfall Intensity Graph

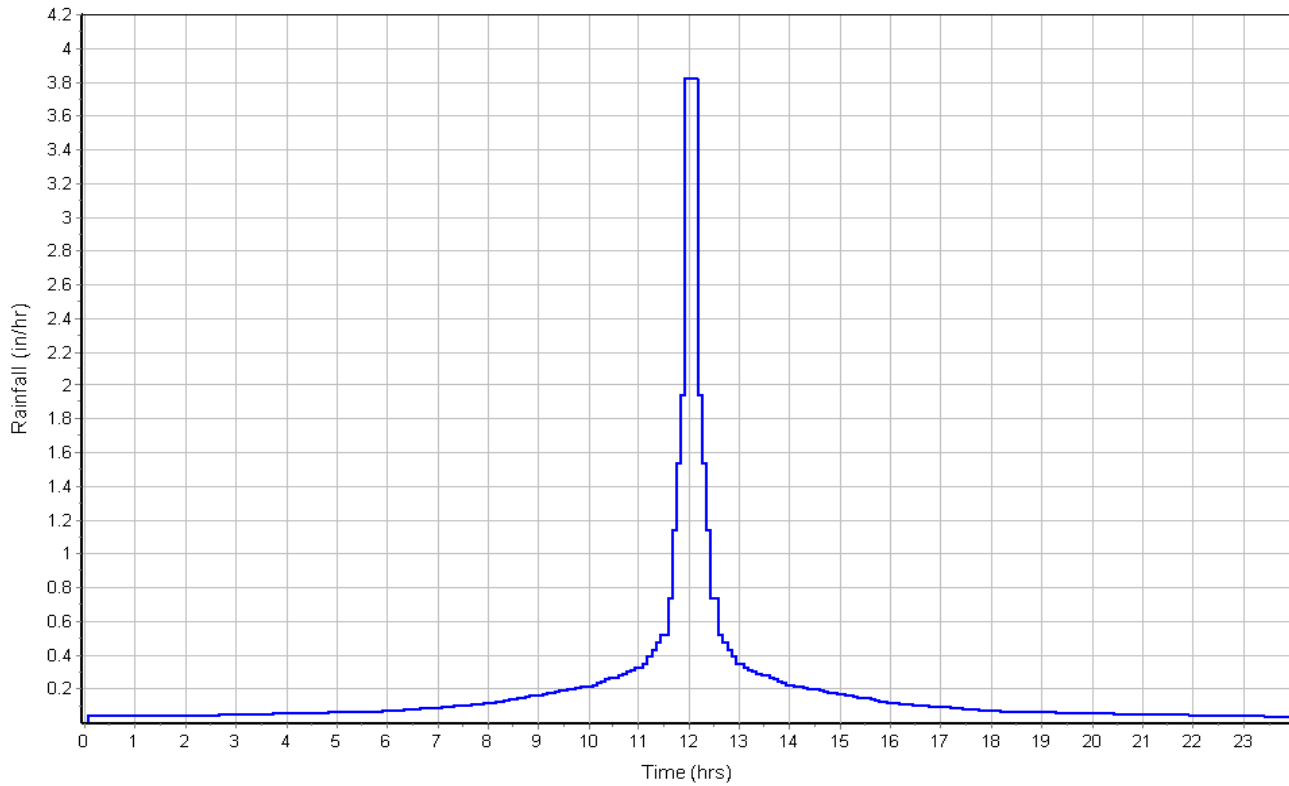

Runoff Hydrograph

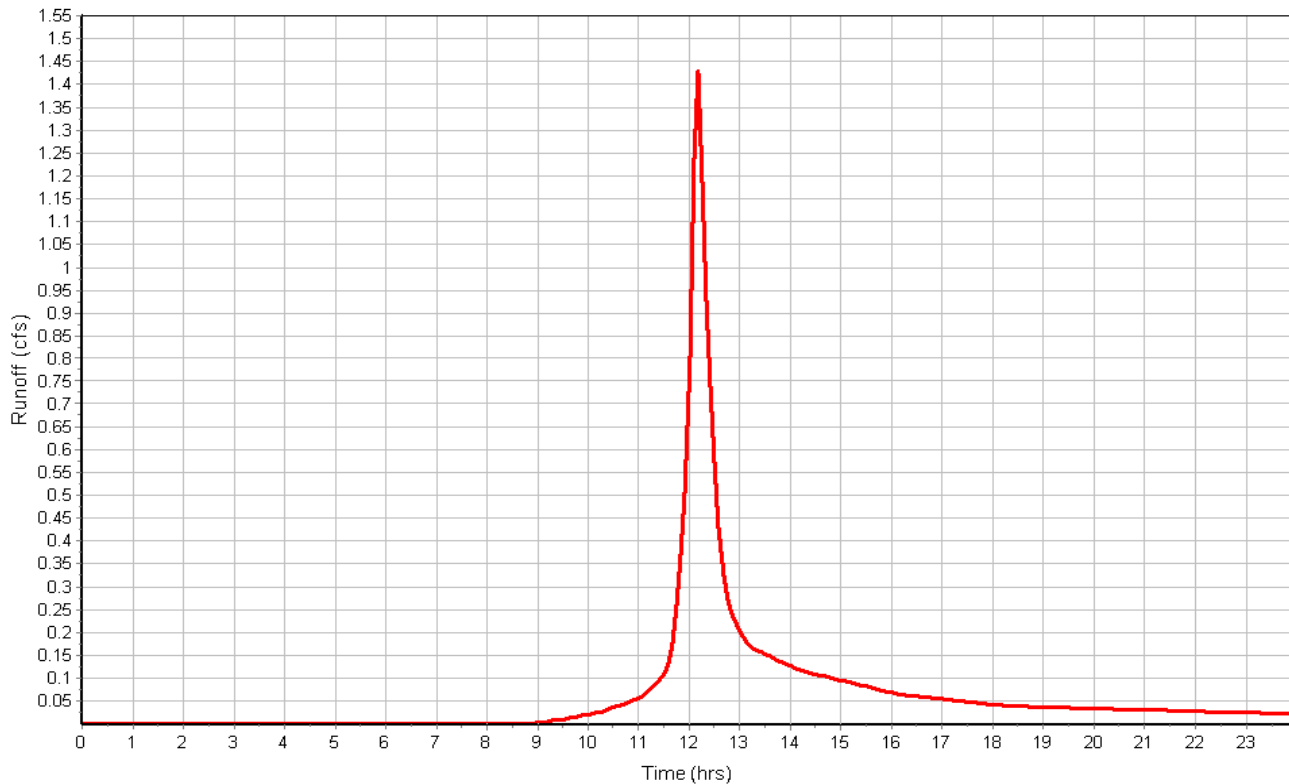

Subbasin : E

Input Data

Area (ac) 2.96
 Weighted Curve Number 77.00
 Rain Gage ID Rain Gage-01

Composite Curve Number

Soil/Surface Description	Area (acres)	Soil Group	Curve Number
Woods, Good	2.96	D	77.00
Composite Area & Weighted CN	2.96		77.00

Time of Concentration

Sheet Flow Computations	Subarea	Subarea	Subarea
	A	B	C
Manning's Roughness :	.6	0.00	0.00
Flow Length (ft) :	100	0.00	0.00
Slope (%) :	24	0.00	0.00
2 yr, 24 hr Rainfall (in) :	3.00	0.00	0.00
Velocity (ft/sec) :	0.15	0.00	0.00
Computed Flow Time (min) :	11.35	0.00	0.00

Shallow Concentrated Flow Computations	Subarea	Subarea	Subarea
	A	B	C
Flow Length (ft) :	227	0.00	0.00
Slope (%) :	18	0.00	0.00
Surface Type :	Woodland	Unpaved	Unpaved
Velocity (ft/sec) :	2.12	0.00	0.00
Computed Flow Time (min) :	1.78	0.00	0.00
Total TOC (min)	13.14		

Subbasin Runoff Results

Total Rainfall (in) 4.55
 Total Runoff (in) 2.25
 Peak Runoff (cfs) 6.01
 Weighted Curve Number 77.00
 Time of Concentration (days hh:mm:ss) 0 00:13:08

Subbasin : E

Rainfall Intensity Graph

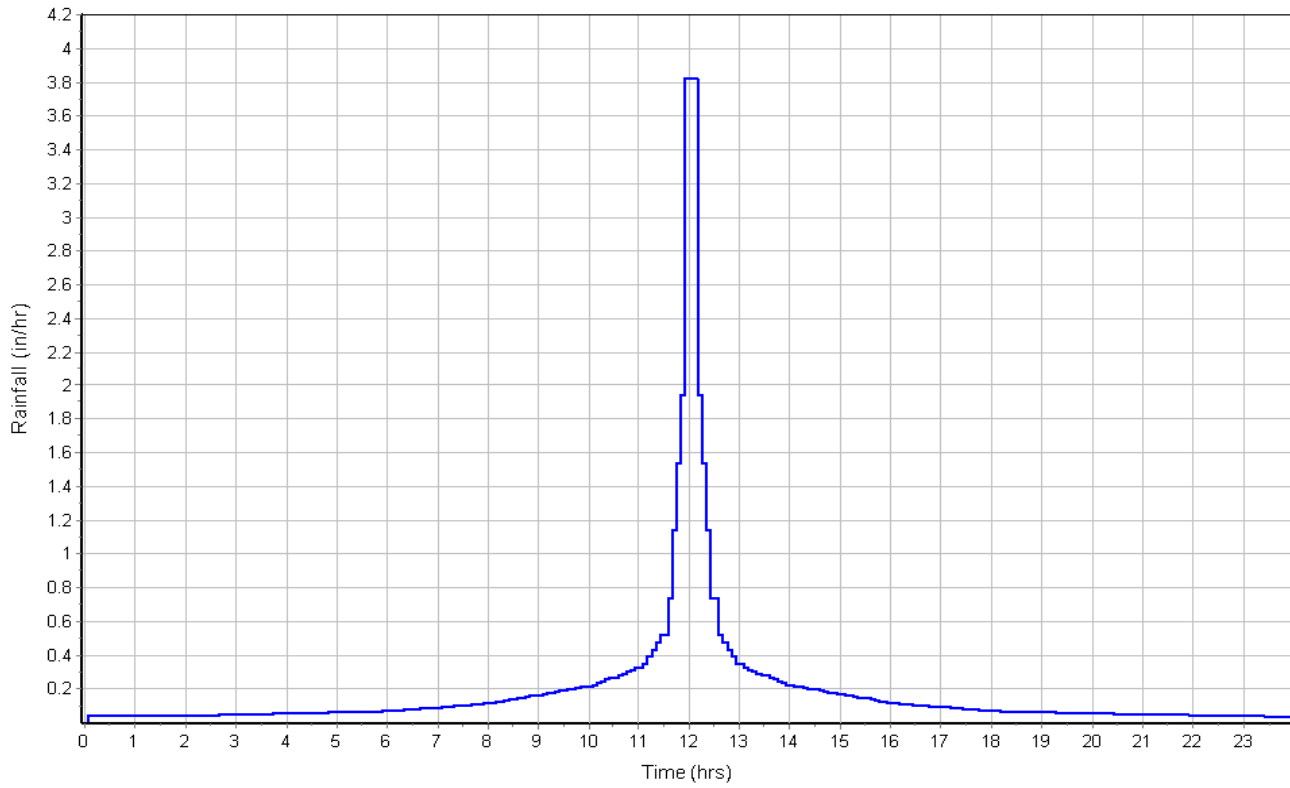

Runoff Hydrograph

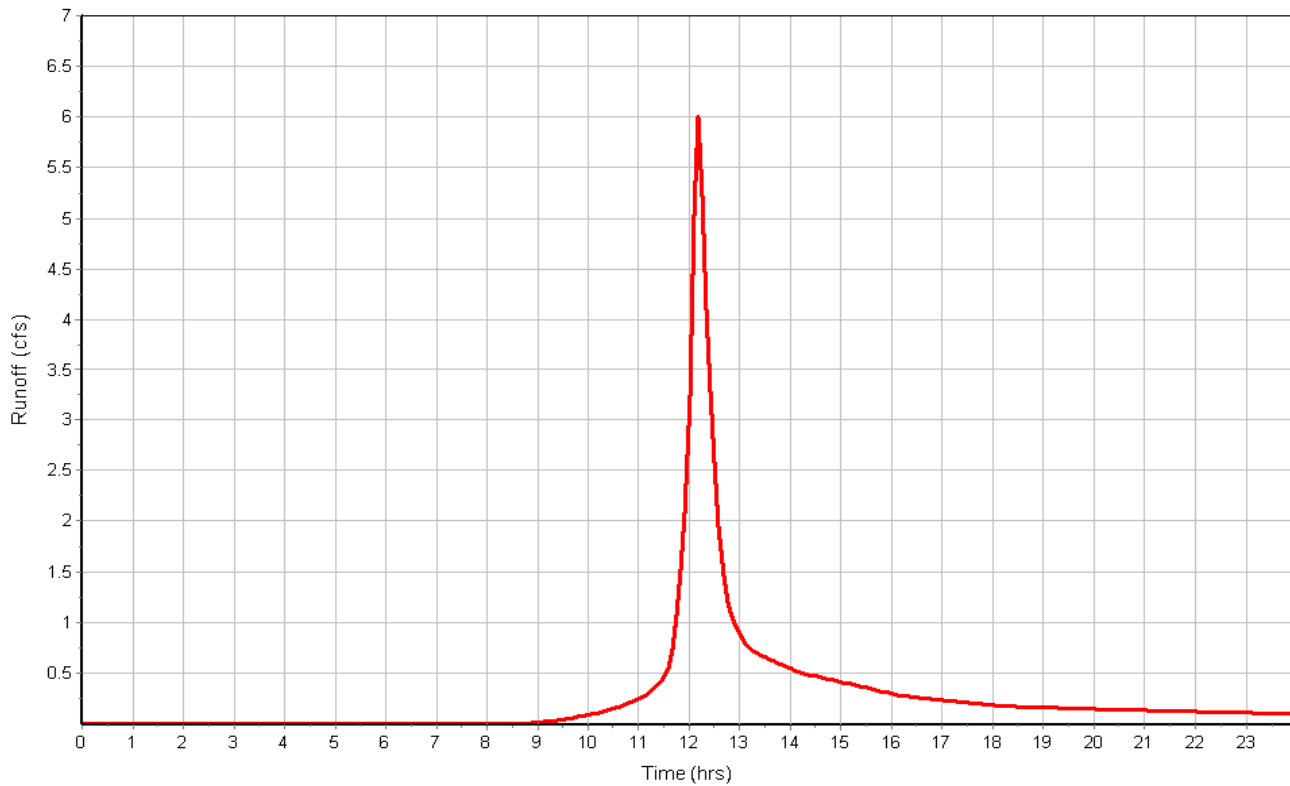

Junction Input

Element ID	Invert Elevation (ft)	Ground/Rim (Max) Elevation (ft)
CB1	305.30	310.33
CB2	312.00	316.00
END-SECTION-C1	308.00	6.00
END-SECTION-C2	308.00	6.00
OUTLET-STR-A2	305.60	312.00
OUTLET-STR-C1	308.10	312.00
OUTLET-STR-C2	308.10	312.00

Junction Results

Element ID	Peak Inflow (cfs)	Max HGL Elevation Attained (ft)	Max HGL Depth Attained (ft)	Min Freeboard Attained (ft)	Average HGL Elevation Attained (ft)	Time of Max HGL Occurrence (days hh:mm)
CB1	11.78	306.76	1.46	3.57	305.58	0 12:29
CB2	15.30	313.07	1.07	2.93	312.15	0 12:15
END-SECTION-C1	0.02	308.08	0.08	3.15	308.07	0 23:46
END-SECTION-C2	0.02	308.08	0.08	3.15	308.07	1 00:00
OUTLET-STR-A2	8.54	306.63	1.03	5.37	305.79	0 12:29
OUTLET-STR-C1	0.02	308.18	0.08	3.82	308.17	0 23:45
OUTLET-STR-C2	0.02	308.18	0.08	3.82	308.17	1 00:00

Pipe Input

Element ID	Length (ft)	Inlet Invert Elevation (ft)	Outlet Invert Elevation (ft)	Average Pipe Slope (%)	Pipe Shape	Pipe Diameter or Height (in)	Pipe Width (in)	Manning's Roughness
CULV-A	98.00	305.30	305.12	0.1800	CIRCULAR	36.000	36.000	0.0150
CULV-A2-1	104.00	312.00	310.00	1.9200	CIRCULAR	24.000	24.000	0.0150
CULV-A2-2	43.00	305.60	305.30	0.7000	CIRCULAR	24.000	24.000	0.0150
CULV-C1	30.00	308.10	308.00	0.3300	CIRCULAR	12.000	12.000	0.0130
CULV-C2	30.00	308.10	308.00	0.3300	CIRCULAR	12.000	12.000	0.0130

Pipe Results

Element ID	Peak Flow	Time of Peak Flow Occurrence	Design Flow Capacity	Peak Flow Velocity	Peak Flow Depth
	(cfs)	(days hh:mm)	(cfs)	(ft/sec)	(ft)
CULV-A	11.78	0 12:29	24.77	3.46	1.46
CULV-A2-1	15.24	0 12:15	27.19	8.91	1.07
CULV-A2-2	8.54	0 12:29	16.38	5.27	1.03
CULV-C1	0.02	0 23:46	2.06	0.89	0.08
CULV-C2	0.02	1 00:00	2.06	0.88	0.08

Storage Nodes

Storage Node : DETENTION-A

Input Data

Invert Elevation (ft) 309.50
Max (Rim) Elevation (ft) 312.00
Max (Rim) Offset (ft) 2.50
Initial Water Elevation (ft) 309.50
Initial Water Depth (ft) 0.00
Ponded Area (ft²) 0.00
Evaporation Loss 0.00

Storage Area Volume Curves

Storage Curve : Storage-08

Stage (ft)	Storage Area (ft ²)	Storage Volume (ft ³)
0	113	0.000
.5	15327	3860.00
1.2	18183.	15588.50
1.5	18635	21111.20
2.5	22257	41557.20

Storage Area Volume Curves

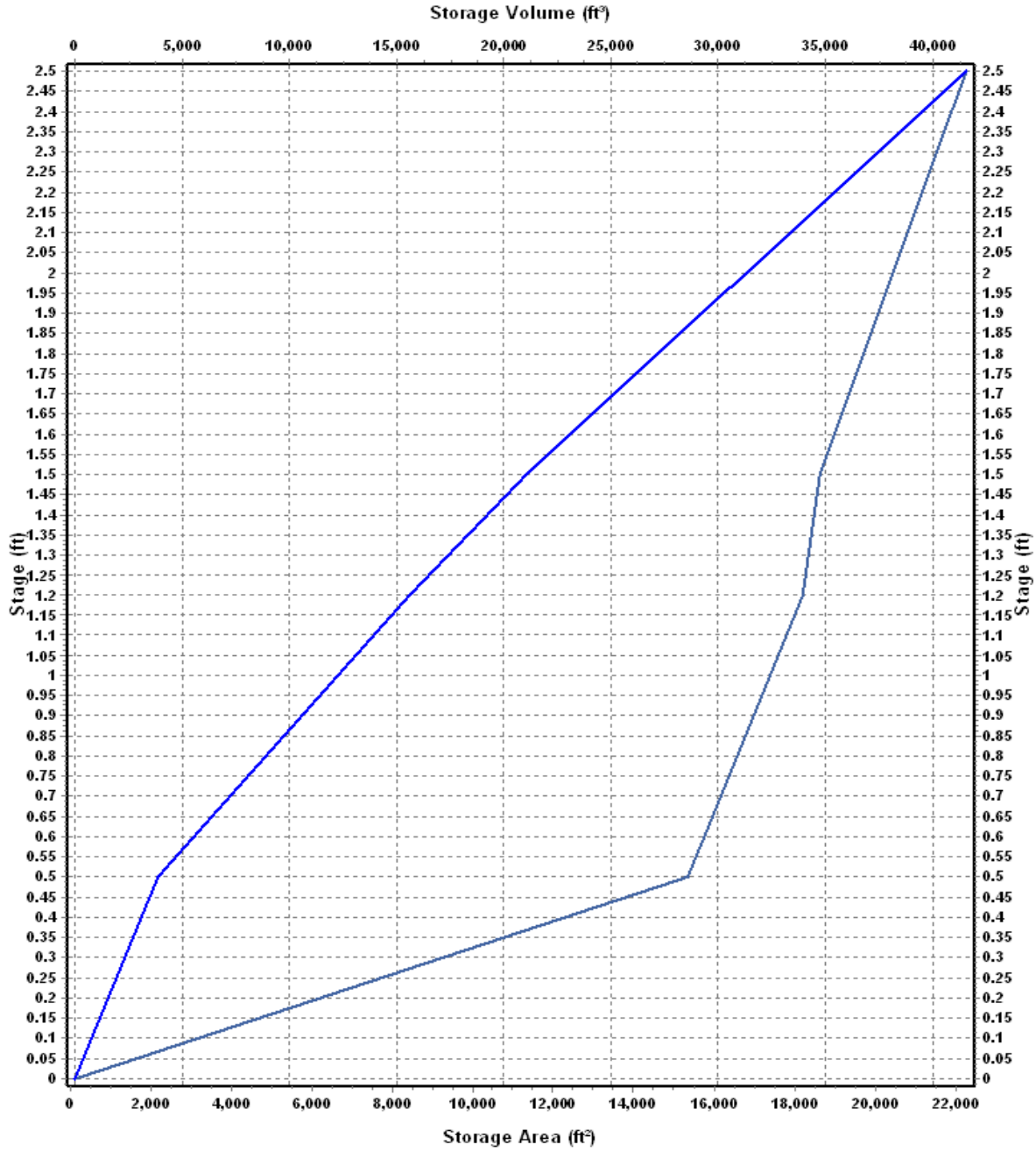

— Storage Area — Storage Volume

Storage Node : DETENTION-A (continued)

Outflow Orifices

Element ID	Orifice Type	Orifice Shape	Circular Orifice Diameter (in)	Rectangular Orifice Height (in)	Rectangular Orifice Width (in)	Orifice Invert Elevation (ft)	Orifice Coefficient
BEEHIVE-GRATE	Bottom	CIRCULAR	18.17			310.33	0.61
ORIF-DET-A	Side	Rectangular		4.00	36.00	309.50	0.63

Output Summary Results

Peak Inflow (cfs)	6.94
Peak Lateral Inflow (cfs)	6.94
Peak Outflow (cfs)	3.24
Peak Exfiltration Flow Rate (cfm)	0.00
Max HGL Elevation Attained (ft)	310.08
Max HGL Depth Attained (ft)	0.58
Average HGL Elevation Attained (ft)	309.57
Average HGL Depth Attained (ft)	0.07
Time of Max HGL Occurrence (days hh:mm)	0 12:30
Total Exfiltration Volume (1000-ft ³)	0.000
Total Flooded Volume (ac-in)	0
Total Time Flooded (min)	0
Total Retention Time (sec)	0.00

Storage Node : FILTER-A2

Input Data

Invert Elevation (ft)	308.00
Max (Rim) Elevation (ft)	312.00
Max (Rim) Offset (ft)	4.00
Initial Water Elevation (ft)	309.00
Initial Water Depth (ft)	1.00
Ponded Area (ft ²)	0.00
Evaporation Loss	0.00

Storage Area Volume Curves

Storage Curve : Storage-05

Stage (ft)	Storage Area (ft ²)	Storage Volume (ft ³)
0	2178	0.000
1	5898	4038.00
2	7084	10529.00
3	8421	18281.50
4	9818	27401.00

Storage Area Volume Curves

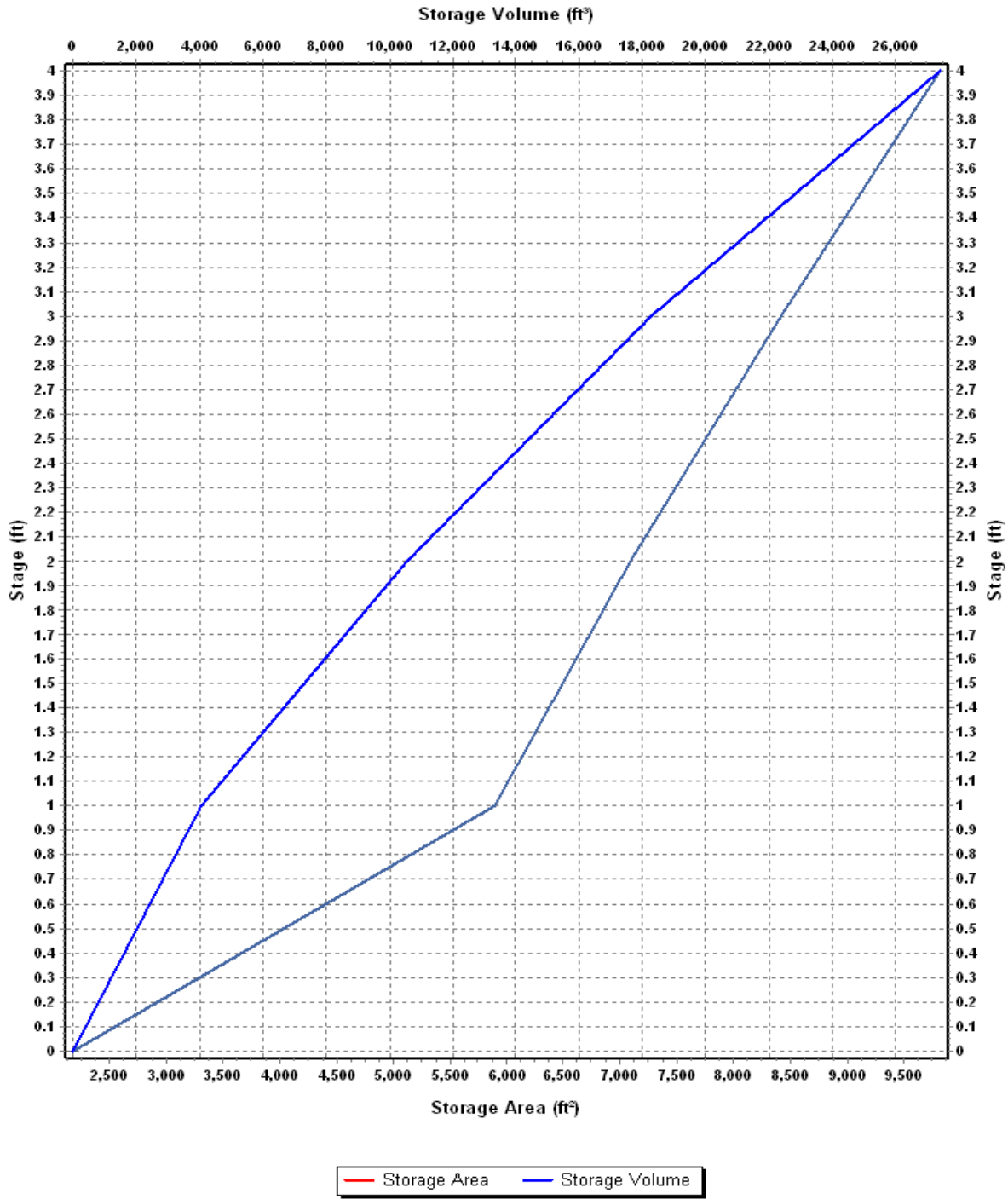

Storage Node : FILTER-A2 (continued)

Outflow Weirs

Element ID	Weir Type	Crest Elevation (ft)	Length (ft)	Weir Total Height (ft)	Discharge Coefficient
SPILLWAY-A2	Trapezoidal	310.70	55.00	1.30	3.10

Outflow Orifices

Element ID	Orifice Type	Orifice Shape	Circular Orifice Diameter (in)	Rectangular Orifice Height (in)	Rectangular Orifice Width (in)	Orifice Invert Elevation (ft)	Orifice Coefficient
ORIF-A2	Side	Rectangular		6.00	35.00	309.00	0.63

Output Summary Results

Peak Inflow (cfs)	15.24
Peak Lateral Inflow (cfs)	0.00
Peak Outflow (cfs)	8.54
Peak Exfiltration Flow Rate (cfm)	0.00
Max HGL Elevation Attained (ft)	310.61
Max HGL Depth Attained (ft)	2.61
Average HGL Elevation Attained (ft)	309.14
Average HGL Depth Attained (ft)	1.14
Time of Max HGL Occurrence (days hh:mm)	0 12:29
Total Exfiltration Volume (1000-ft ³)	0.000
Total Flooded Volume (ac-in)	0
Total Time Flooded (min)	0
Total Retention Time (sec)	0.00

Storage Node : WETLAND-C1

Input Data

Invert Elevation (ft)	308.77
Max (Rim) Elevation (ft)	312.00
Max (Rim) Offset (ft)	3.23
Initial Water Elevation (ft)	309.33
Initial Water Depth (ft)	0.56
Ponded Area (ft ²)	0.00
Evaporation Loss	0.00

Storage Area Volume Curves

Storage Curve : Storage-09

Stage (ft)	Storage Area (ft ²)	Storage Volume (ft ³)
0	2183	0.000
.57	2815	1424.43
1.33	3441	3801.71
2.33	4347	7695.71
3.33	5324	12531.21

Storage Area Volume Curves

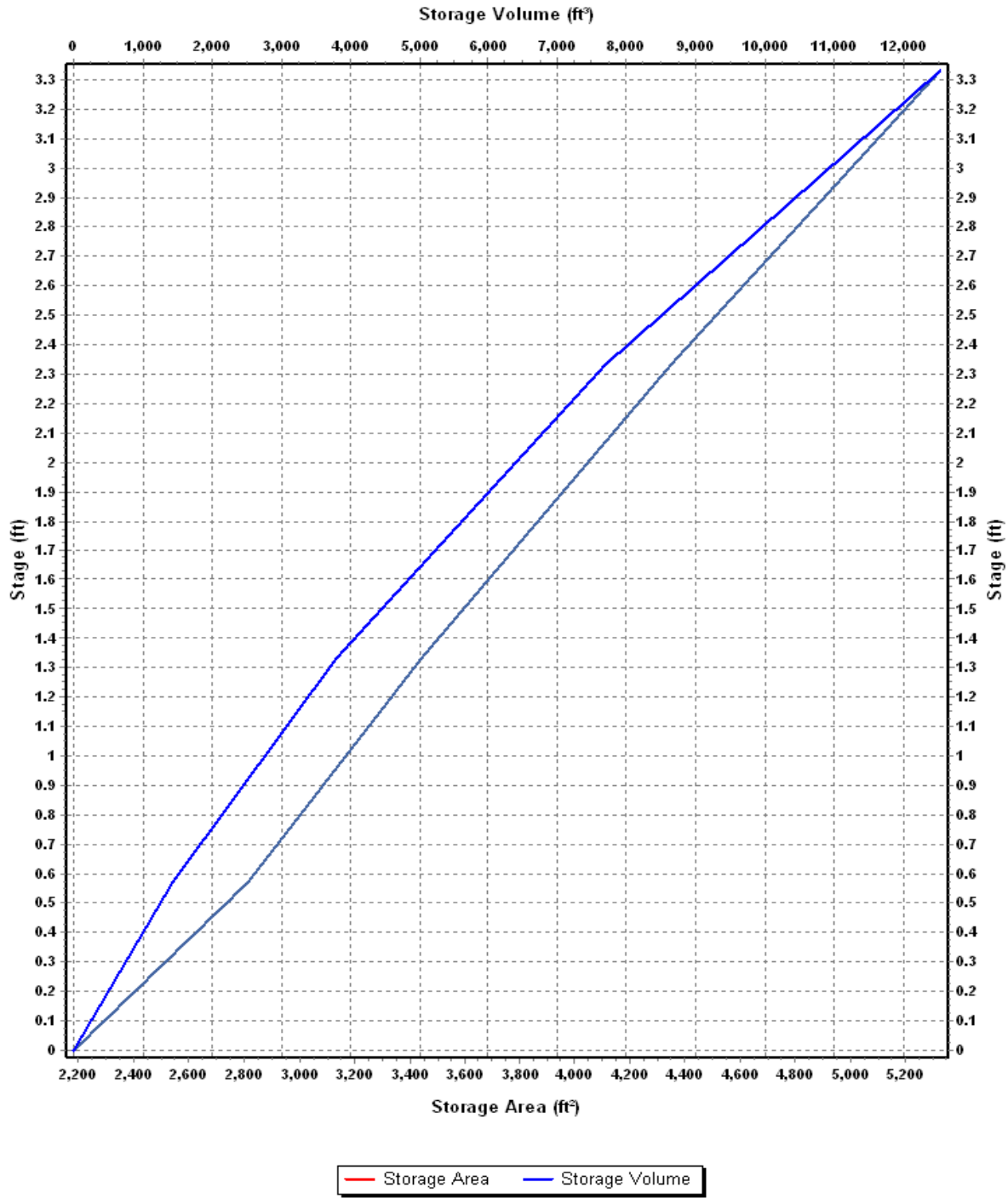

Storage Node : WETLAND-C1 (continued)

Outflow Weirs

Element ID	Weir Type	Crest Elevation (ft)	Length (ft)	Weir Total Height (ft)	Discharge Coefficient
SPILLWAY-C1	Trapezoidal	310.70	10.00	1.30	3.33

Outflow Orifices

Element ID	Orifice Type	Orifice Shape	Circular Orifice Diameter (in)	Rectangular Orifice Height (in)	Rectangular Orifice Width (in)	Orifice Invert Elevation (ft)	Orifice Coefficient
ORIF-C1	Side	CIRCULAR	0.83			308.10	0.61

Output Summary Results

Peak Inflow (cfs)	1.66
Peak Lateral Inflow (cfs)	1.66
Peak Outflow (cfs)	0.02
Peak Exfiltration Flow Rate (cfm)	0.00
Max HGL Elevation Attained (ft)	310.61
Max HGL Depth Attained (ft)	1.84
Average HGL Elevation Attained (ft)	309.87
Average HGL Depth Attained (ft)	1.1
Time of Max HGL Occurrence (days hh:mm)	0 23:45
Total Exfiltration Volume (1000-ft ³)	0.000
Total Flooded Volume (ac-in)	0
Total Time Flooded (min)	0
Total Retention Time (sec)	0.00

Storage Node : WETLAND-C2

Input Data

Invert Elevation (ft)	308.77
Max (Rim) Elevation (ft)	312.00
Max (Rim) Offset (ft)	3.23
Initial Water Elevation (ft)	309.42
Initial Water Depth (ft)	0.65
Ponded Area (ft ²)	0.00
Evaporation Loss	0.00

Storage Area Volume Curves

Storage Curve : Storage-07

Stage (ft)	Storage Area (ft ²)	Storage Volume (ft ³)
0	2828	0.000
.57	3522	1809.75
1.23	5207	4690.32
2.33	7549	11706.12
3.33	8345	19653.12

Storage Area Volume Curves

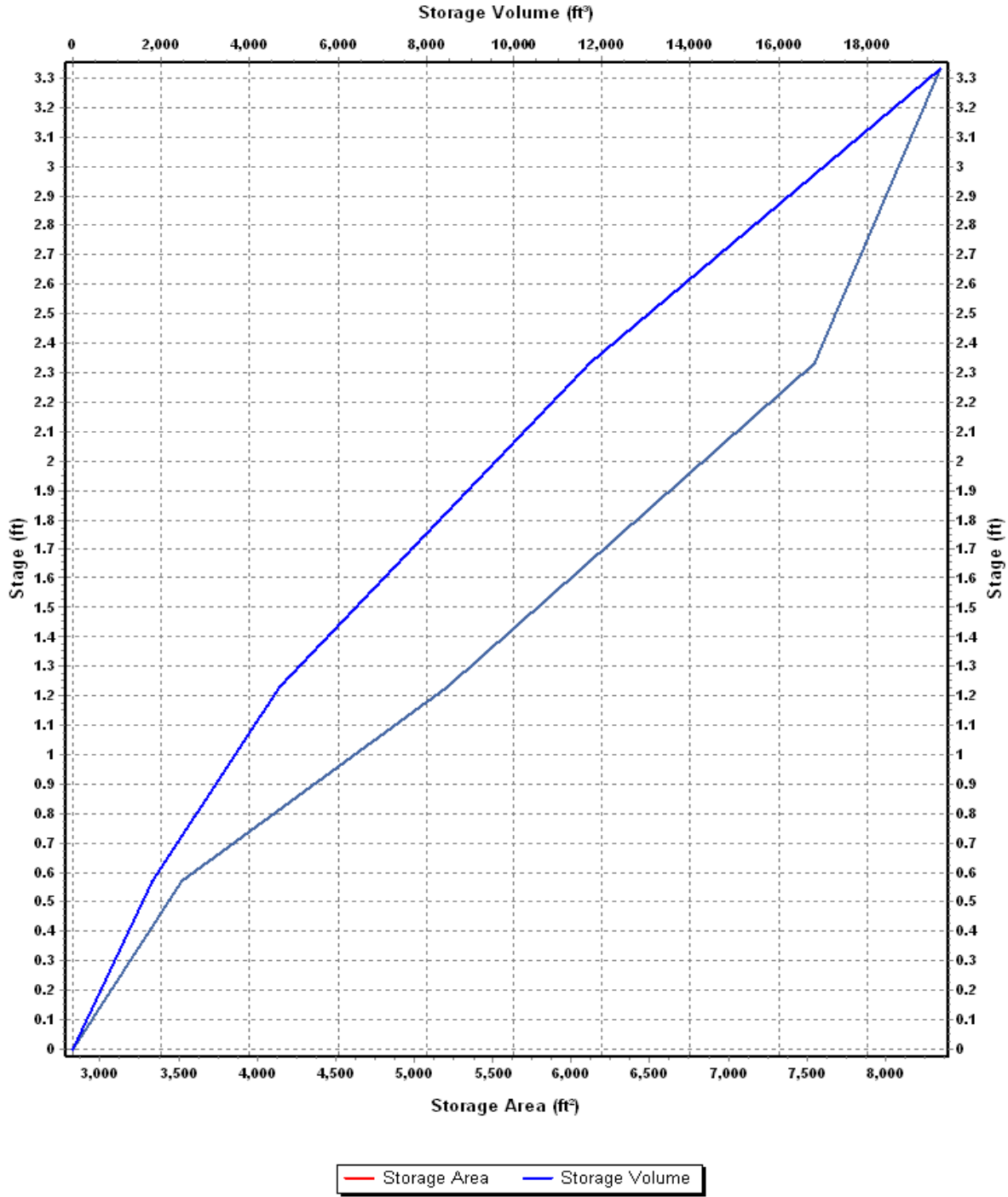

Storage Node : WETLAND-C2 (continued)

Outflow Weirs

Element ID	Weir Type	Crest Elevation (ft)	Length (ft)	Weir Total Height (ft)	Discharge Coefficient
SPILLWAY-C2	Trapezoidal	310.80	10.00	1.20	3.10

Outflow Orifices

Element ID	Orifice Type	Orifice Shape	Circular Orifice Diameter (in)	Rectangular Orifice Height (in)	Rectangular Orifice Width (in)	Orifice Invert Elevation (ft)	Orifice Coefficient
ORIF-C2A	Side	CIRCULAR	0.83			308.10	0.61

Output Summary Results

Peak Inflow (cfs)	1.39
Peak Lateral Inflow (cfs)	1.39
Peak Outflow (cfs)	0.02
Peak Exfiltration Flow Rate (cfm)	0.00
Max HGL Elevation Attained (ft)	310.52
Max HGL Depth Attained (ft)	1.75
Average HGL Elevation Attained (ft)	309.88
Average HGL Depth Attained (ft)	1.11
Time of Max HGL Occurrence (days hh:mm)	1 00:00
Total Exfiltration Volume (1000-ft ³)	0.000
Total Flooded Volume (ac-in)	0
Total Time Flooded (min)	0
Total Retention Time (sec)	0.00

Project Description

File Name Proposed Conditions 7-2-18.SPF

Project Options

Flow Units CFS
 Elevation Type Elevation
 Hydrology Method SCS TR-55
 Time of Concentration (TOC) Method SCS TR-55
 Link Routing Method Kinematic Wave
 Enable Overflow Ponding at Nodes YES
 Skip Steady State Analysis Time Periods NO

Analysis Options

Start Analysis On Jul 13, 2017 00:00:00
 End Analysis On Jul 14, 2017 00:00:00
 Start Reporting On Jul 13, 2017 00:00:00
 Antecedent Dry Days 0 days
 Runoff (Dry Weather) Time Step 0 01:00:00 days hh:mm:ss
 Runoff (Wet Weather) Time Step 0 00:05:00 days hh:mm:ss
 Reporting Time Step 0 00:05:00 days hh:mm:ss
 Routing Time Step 30 seconds

Number of Elements

	Qty
Rain Gages	1
Subbasins.....	9
Nodes.....	16
<i>Junctions</i>	7
<i>Outfalls</i>	5
<i>Flow Diversions</i>	0
<i>Inlets</i>	0
<i>Storage Nodes</i>	4
Links.....	15
<i>Channels</i>	2
<i>Pipes</i>	5
<i>Pumps</i>	0
<i>Orifices</i>	5
<i>Weirs</i>	3
<i>Outlets</i>	0
Pollutants	0
Land Uses	0

Rainfall Details

SN	Rain Gage ID	Data Source	Data Source ID	Rainfall Type	Rain Units	State	County	Return Period (years)	Rainfall Depth (inches)	Rainfall Distribution
1	Rain Gage-01	Time Series	TS-25	Cumulative	inches	Maine	Androscoggin	25	5.49	SCS Type III 24-hr

Subbasin Summary

Subbasin ID	Area (ac)	Weighted Curve Number	Total Rainfall (in)	Total Runoff (in)	Total Runoff Volume (ac-in)	Peak Runoff (cfs)	Time of Concentration (days hh:mm:ss)
A1	12.28	73.16	5.49	2.69	32.97	17.35	0 00:49:44
A2	6.41	81.47	5.49	3.47	22.23	20.10	0 00:12:48
A3	4.01	71.75	5.49	2.56	10.27	10.03	0 00:09:08
B	5.14	75.65	5.49	2.91	14.97	10.95	0 00:24:28
C1-WETLAND	0.75	75.95	5.49	2.94	2.21	2.30	0 00:05:00
C2-WETLAND	0.73	82.63	5.49	3.58	2.62	1.82	0 00:27:24
C3-BYPASS	21.22	71.79	5.49	2.56	54.39	19.95	0 01:29:22
D	0.69	77.00	5.49	3.04	2.10	1.93	0 00:12:07
E	2.96	77.00	5.49	3.04	8.99	8.13	0 00:13:08

Node Summary

Element ID	Element Type	Invert Elevation
		(ft)
CB1	Junction	305.30
CB2	Junction	312.00
END-SECTION-C1	Junction	308.00
END-SECTION-C2	Junction	308.00
OUTLET-STR-A2	Junction	305.60
OUTLET-STR-C1	Junction	308.10
OUTLET-STR-C2	Junction	308.10
OUT-A	Outfall	298.00
OUT-B	Outfall	310.00
OUT-C	Outfall	298.00
OUT-D	Outfall	338.00
OUT-E	Outfall	298.00
DETENTION-A	Storage Node	309.50
FILTER-A2	Storage Node	308.00
WETLAND-C1	Storage Node	308.77
WETLAND-C2	Storage Node	308.77

Link Summary

Element ID	Element Type	From (Inlet) Node	To (Outlet) Node	Length (ft)	Inlet Invert Elevation (ft)	Outlet Invert Elevation (ft)	Average Slope (%)	Diameter or Height (in)	Manning's Roughness	Peak Flow (cfs)	Design Flow Capacity (cfs)	Peak Flow Velocity (ft/sec)	Peak Flow Depth (ft)
CULV-A	Pipe	CB1	OUT-A	98.00	305.30	305.12	0.1800	36.000	0.0150	14.63	24.77	3.65	1.66
CULV-A2-1	Pipe	CB2	FILTER-A2	104.00	312.00	310.00	1.9200	24.000	0.0150	20.01	27.19	9.48	1.28
CULV-A2-2	Pipe	OUTLET-STR-A2	CB1	43.00	305.60	305.30	0.7000	24.000	0.0150	9.20	16.38	5.36	1.07
CULV-C1	Pipe	OUTLET-STR-C1	END-SECTION-C1	30.00	308.10	308.00	0.3300	12.000	0.0130	0.03	2.06	0.90	0.08
CULV-C2	Pipe	OUTLET-STR-C2	END-SECTION-C2	30.00	308.10	308.00	0.3300	12.000	0.0130	0.03	2.06	0.91	0.08
WETLAND-CHANNEL-C1	Channel	END-SECTION-C1	OUT-C	2050.00	308.00	298.00	0.4900	6.000	0.0320	0.10	101.48	0.00	0.01
WETLAND-CHANNEL-C2	Channel	END-SECTION-C2	OUT-C	1712.00	308.00	298.00	0.5800	6.000	0.0320	0.04	111.05	0.00	0.00
BEEHIVE-GRATE	Orifice	DETENTION-A	CB1		309.50	305.30		18.167		1.09			
ORIF-A2	Orifice	FILTER-A2	OUTLET-STR-A2		308.00	305.60		6.000		9.20			
ORIF-C1	Orifice	WETLAND-C1	OUTLET-STR-C1		308.77	308.10		0.830		0.03			
ORIF-C2A	Orifice	WETLAND-C2	OUTLET-STR-C2		308.77	308.10		0.830		0.03			
ORIF-DET-A	Orifice	DETENTION-A	CB1		309.50	305.30		4.000		4.58			
SPILLWAY-A2	Weir	FILTER-A2	DETENTION-A		308.00	309.50				7.62			
SPILLWAY-C1	Weir	WETLAND-C1	END-SECTION-C1		308.77	308.00				0.14			
SPILLWAY-C2	Weir	WETLAND-C2	END-SECTION-C2		308.77	308.00				0.02			

Subbasin Hydrology

Subbasin : A1

Input Data

Area (ac) 12.28
Weighted Curve Number 73.16
Rain Gage ID Rain Gage-01

Composite Curve Number

Soil/Surface Description	Area (acres)	Soil Group	Curve Number
Woods, Good	4.58	D	77.00
> 75% grass cover, Good	0.68	C	74.00
Woods, Good	6.62	C	70.00
> 75% grass cover, Good	0.40	D	80.00
Composite Area & Weighted CN	12.28		73.16

Time of Concentration

TOC Method : SCS TR-55

Sheet Flow Equation :

$$T_c = (0.007 * ((n * L_f)^{0.8})) / ((P^{0.5}) * (S_f^{0.4}))$$

Where :

T_c = Time of Concentration (hr)
n = Manning's roughness
L_f = Flow Length (ft)
P = 2 yr, 24 hr Rainfall (inches)
S_f = Slope (ft/ft)

Shallow Concentrated Flow Equation :

V = 16.1345 * (S_f^{0.5}) (unpaved surface)
V = 20.3282 * (S_f^{0.5}) (paved surface)
V = 15.0 * (S_f^{0.5}) (grassed waterway surface)
V = 10.0 * (S_f^{0.5}) (nearly bare & untilled surface)
V = 9.0 * (S_f^{0.5}) (cultivated straight rows surface)
V = 7.0 * (S_f^{0.5}) (short grass pasture surface)
V = 5.0 * (S_f^{0.5}) (woodland surface)
V = 2.5 * (S_f^{0.5}) (forest w/heavy litter surface)
T_c = (L_f / V) / (3600 sec/hr)

Where:

T_c = Time of Concentration (hr)
L_f = Flow Length (ft)
V = Velocity (ft/sec)
S_f = Slope (ft/ft)

Channel Flow Equation :

$$V = (1.49 * (R^{2/3})) * (S_f^{0.5}) / n$$

$$R = A_q / W_p$$

$$T_c = (L_f / V) / (3600 \text{ sec/hr})$$

Where :

T_c = Time of Concentration (hr)
L_f = Flow Length (ft)
R = Hydraulic Radius (ft)
A_q = Flow Area (ft²)
W_p = Wetted Perimeter (ft)
V = Velocity (ft/sec)
S_f = Slope (ft/ft)
n = Manning's roughness

	Subarea	Subarea	Subarea
	A	B	C
Sheet Flow Computations			
Manning's Roughness :	.6	0.00	0.00
Flow Length (ft) :	100	0.00	0.00
Slope (%) :	2	0.00	0.00
2 yr, 24 hr Rainfall (in) :	3.00	0.00	0.00
Velocity (ft/sec) :	0.05	0.00	0.00
Computed Flow Time (min) :	30.68	0.00	0.00
	Subarea	Subarea	Subarea
	A	B	C
Shallow Concentrated Flow Computations			
Flow Length (ft) :	1510	0.00	0.00
Slope (%) :	.78	0.00	0.00
Surface Type :		Unpaved	Unpaved
Velocity (ft/sec) :	1.32	0.00	0.00
Computed Flow Time (min) :	19.07	0.00	0.00
Total TOC (min)	49.74		

Subbasin Runoff Results

Total Rainfall (in)	5.49
Total Runoff (in)	2.69
Peak Runoff (cfs)	17.35
Weighted Curve Number	73.16
Time of Concentration (days hh:mm:ss)	0 00:49:44

Subbasin : A1

Rainfall Intensity Graph

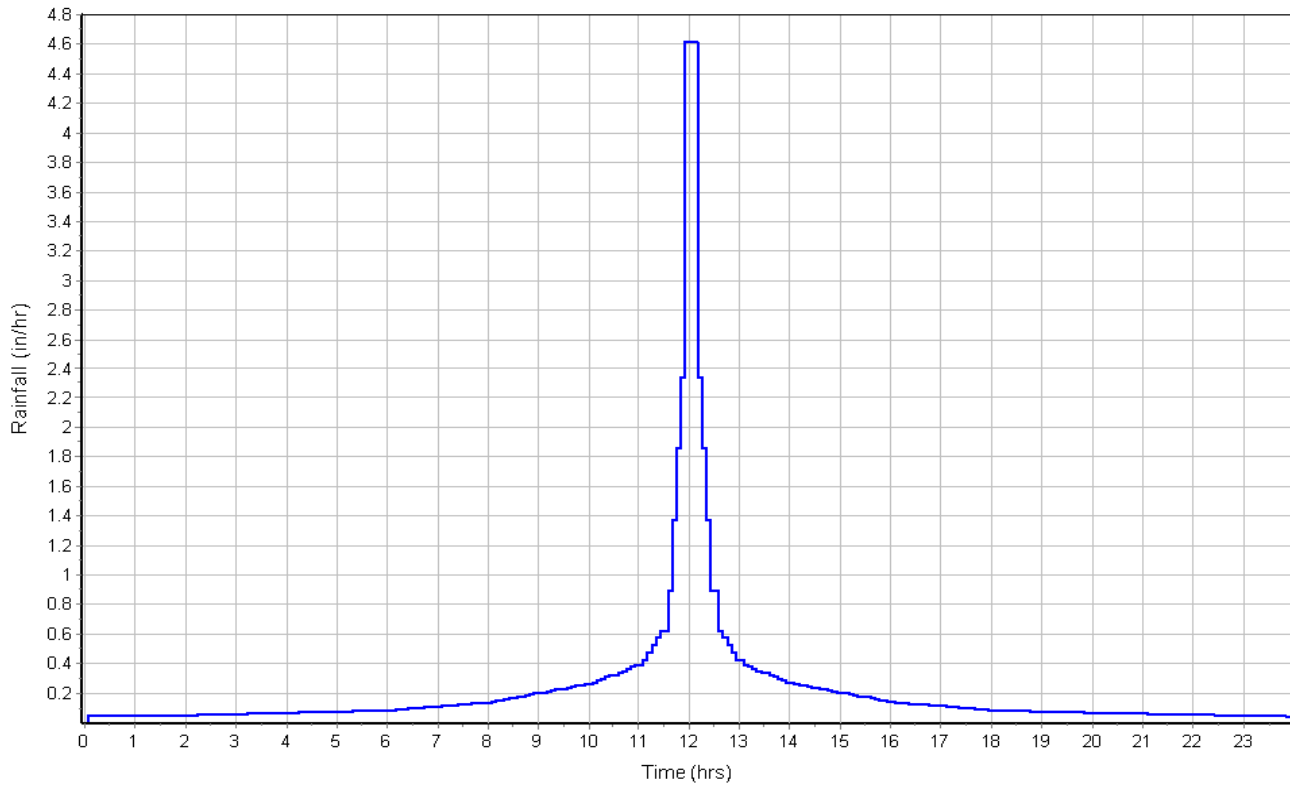

Runoff Hydrograph

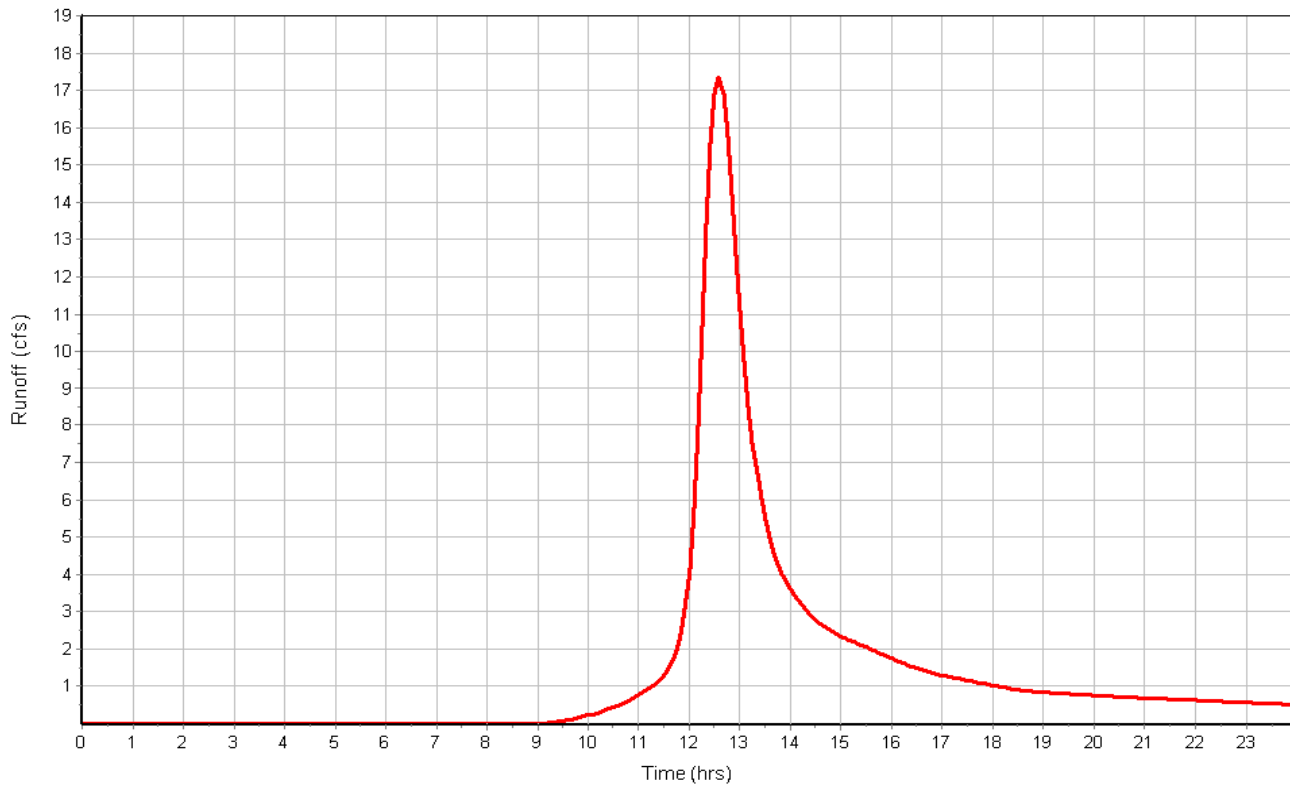

Subbasin : A2

Input Data

Area (ac) 6.41
 Weighted Curve Number 81.47
 Rain Gage ID Rain Gage-01

Composite Curve Number

Soil/Surface Description	Area (acres)	Soil Group	Curve Number
Woods, Good	0.13	D	77.00
Roofs	1.77	D	98.00
> 75% grass cover, Good	1.87	D	80.00
Stone_Pad	1.80	D	60.00
Gravel roads	0.17	D	91.00
Pavement	0.67	D	98.00
Composite Area & Weighted CN	6.41		81.47

Time of Concentration

	Subarea A	Subarea B	Subarea C
Sheet Flow Computations			
Manning's Roughness :	.4	0.00	0.00
Flow Length (ft) :	85	0.00	0.00
Slope (%) :	33.33	0.00	0.00
2 yr, 24 hr Rainfall (in) :	3.00	0.00	0.00
Velocity (ft/sec) :	0.22	0.00	0.00
Computed Flow Time (min) :	6.32	0.00	0.00
Channel Flow Computations			
Manning's Roughness :	.04	0.00	0.00
Flow Length (ft) :	1138	0.00	0.00
Channel Slope (%) :	1.4	0.00	0.00
Cross Section Area (ft ²) :	4.398	0.00	0.00
Wetted Perimeter (ft) :	8.12	0.00	0.00
Velocity (ft/sec) :	2.93	0.00	0.00
Computed Flow Time (min) :	6.48	0.00	0.00
Total TOC (min)	12.80		

Subbasin Runoff Results

Total Rainfall (in) 5.49
 Total Runoff (in) 3.47
 Peak Runoff (cfs) 20.10
 Weighted Curve Number 81.47
 Time of Concentration (days hh:mm:ss) 0 00:12:48

Subbasin : A2

Rainfall Intensity Graph

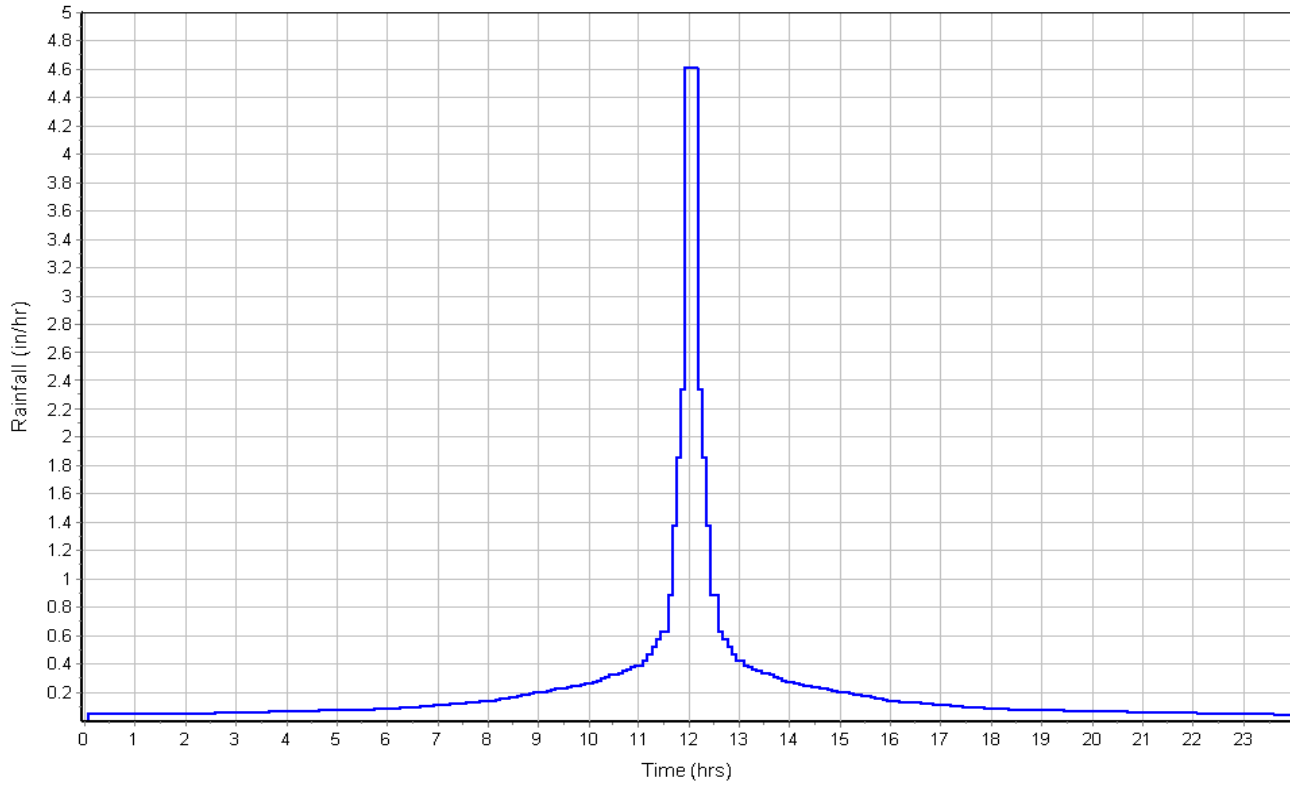

Runoff Hydrograph

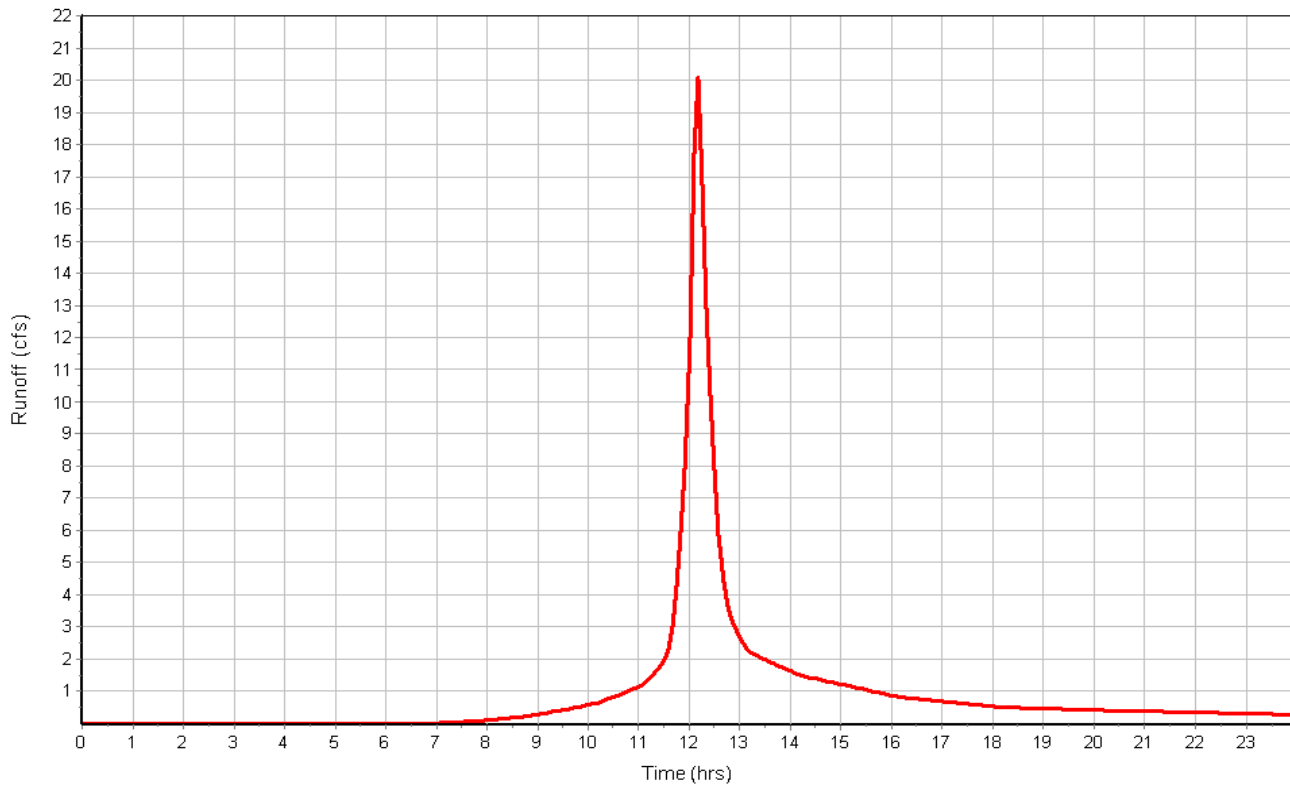

Subbasin : A3

Input Data

Area (ac) 4.01
 Weighted Curve Number 71.75
 Rain Gage ID Rain Gage-01

Composite Curve Number

Soil/Surface Description	Area (acres)	Soil Group	Curve Number
> 75% grass cover, Good	0.75	D	80.00
> 75% grass cover, Good	0.14	C	74.00
Stone_Pad	2.28	D	60.00
Roofs	0.19	D	98.00
Gravel roads	0.25	D	91.00
Pavement	0.35	D	98.00
Foundations	0.05	D	98.00
Composite Area & Weighted CN	4.01		71.75

Time of Concentration

Sheet Flow Computations	Subarea	Subarea	Subarea
	A	B	C
Manning's Roughness :	.01	0.00	0.00
Flow Length (ft) :	100	0.00	0.00
Slope (%) :	2	0.00	0.00
2 yr, 24 hr Rainfall (in) :	3.00	0.00	0.00
Velocity (ft/sec) :	1.44	0.00	0.00
Computed Flow Time (min) :	1.16	0.00	0.00

Shallow Concentrated Flow Computations	Subarea	Subarea	Subarea
	A	B	C
Flow Length (ft) :	548	25	200
Slope (%) :	2	33.33	1.5
Surface Type :	Unpaved		
Velocity (ft/sec) :	2.28	4.04	0.86
Computed Flow Time (min) :	4.01	0.10	3.88
Total TOC (min)	9.14		

Subbasin Runoff Results

Total Rainfall (in) 5.49
 Total Runoff (in) 2.56
 Peak Runoff (cfs) 10.03
 Weighted Curve Number 71.75
 Time of Concentration (days hh:mm:ss) 0 00:09:08

Subbasin : A3

Rainfall Intensity Graph

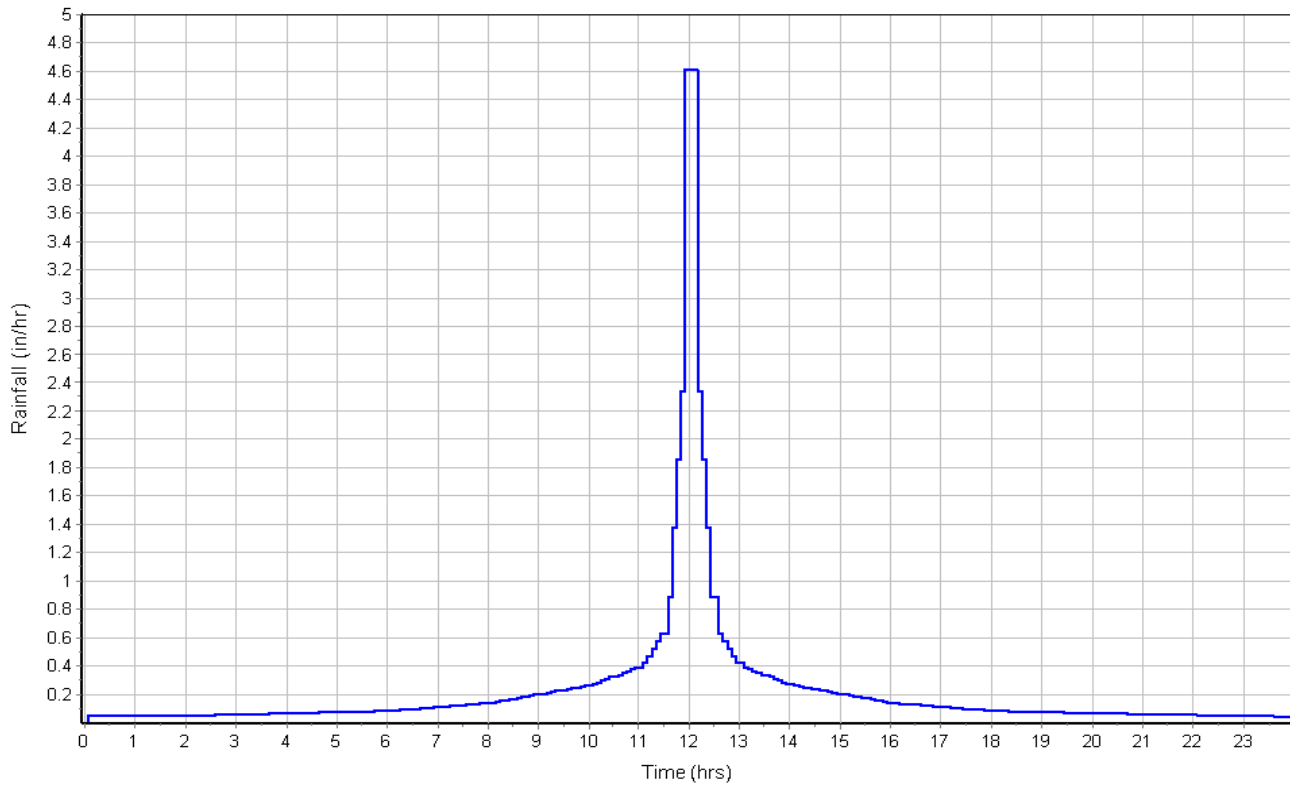

Runoff Hydrograph

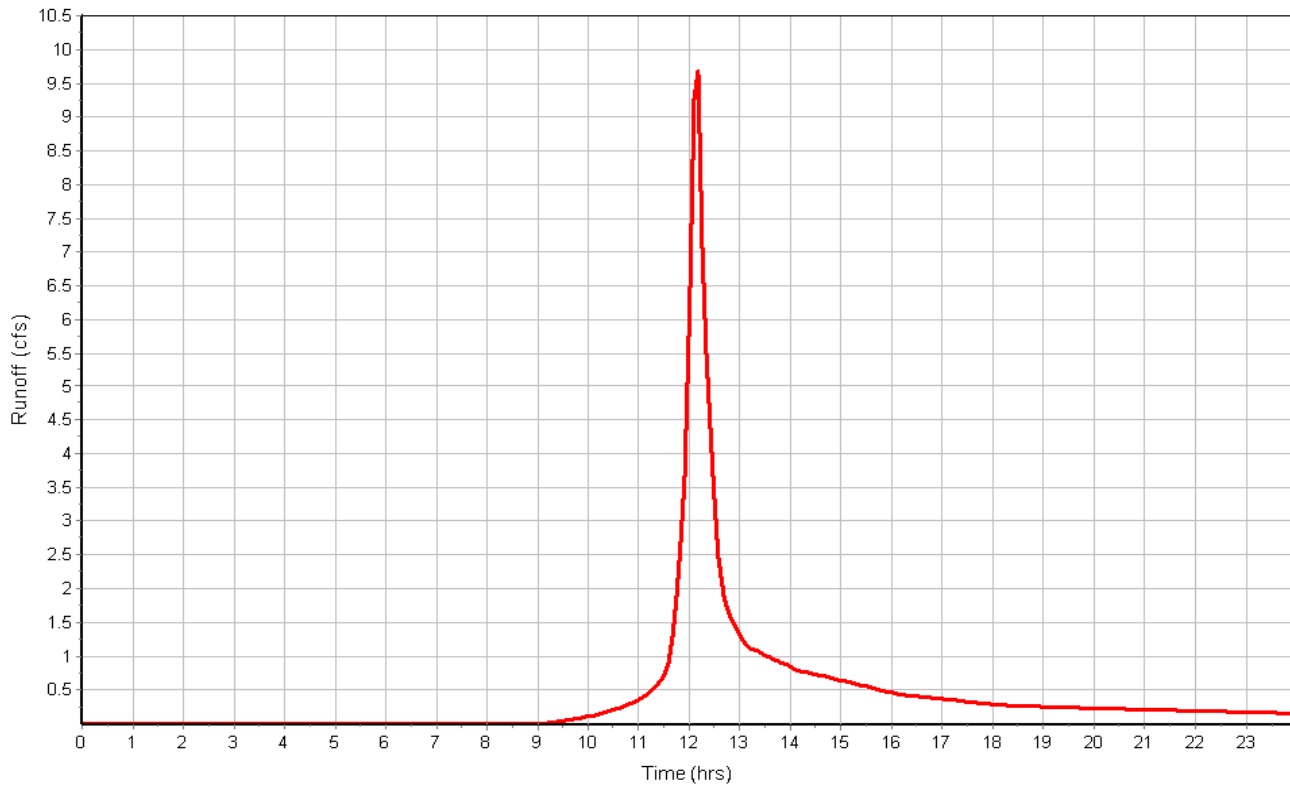

Subbasin : B

Input Data

Area (ac) 5.14
 Weighted Curve Number 75.65
 Rain Gage ID Rain Gage-01

Composite Curve Number

Soil/Surface Description	Area (acres)	Soil Group	Curve Number
Woods, Good	1.20	C	70.00
Woods, Good	3.45	D	77.00
> 75% grass cover, Good	0.49	D	80.00
Composite Area & Weighted CN	5.14		75.65

Time of Concentration

	Subarea A	Subarea B	Subarea C
Sheet Flow Computations			
Manning's Roughness :	.4	0.00	0.00
Flow Length (ft) :	90	0.00	0.00
Slope (%) :	33.33	0.00	0.00
2 yr, 24 hr Rainfall (in) :	3.00	0.00	0.00
Velocity (ft/sec) :	0.23	0.00	0.00
Computed Flow Time (min) :	6.62	0.00	0.00
Shallow Concentrated Flow Computations			
Flow Length (ft) :	368	0.00	0.00
Slope (%) :	1.63	0.00	0.00
Surface Type :		Unpaved	Unpaved
Velocity (ft/sec) :	1.92	0.00	0.00
Computed Flow Time (min) :	3.19	0.00	0.00
Channel Flow Computations			
Manning's Roughness :	.3	.3	0.00
Flow Length (ft) :	272	85	0.00
Channel Slope (%) :	1.4	16.7	0.00
Cross Section Area (ft ²) :	3.287	1.367	0.00
Wetted Perimeter (ft) :	7.17	5.15	0.00
Velocity (ft/sec) :	0.35	0.84	0.00
Computed Flow Time (min) :	12.97	1.69	0.00
Total TOC (min)	24.48		

Subbasin Runoff Results

Total Rainfall (in) 5.49
 Total Runoff (in) 2.91
 Peak Runoff (cfs) 10.95
 Weighted Curve Number 75.65
 Time of Concentration (days hh:mm:ss) 0 00:24:29

Subbasin : B

Rainfall Intensity Graph

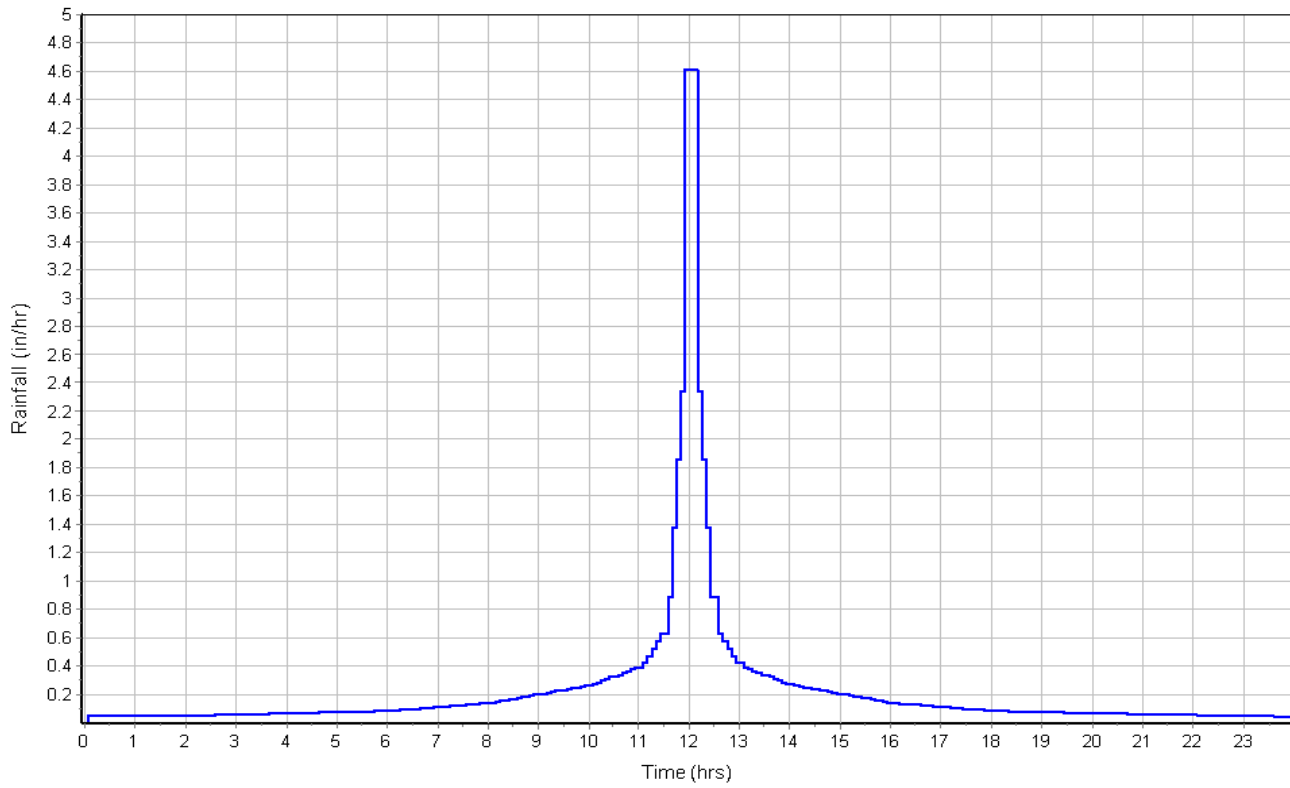

Runoff Hydrograph

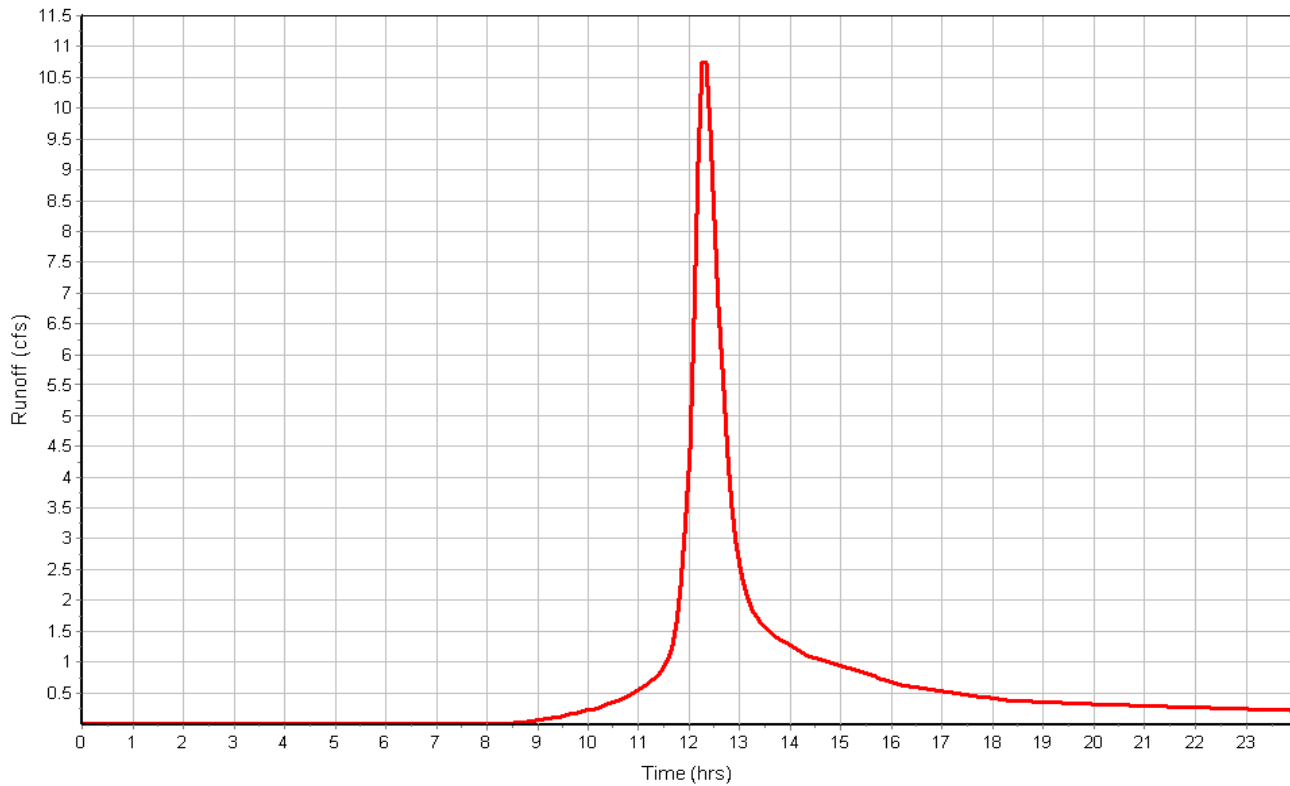

Subbasin : C1-WETLAND

Input Data

Area (ac) 0.75
Weighted Curve Number 75.95
Rain Gage ID Rain Gage-01

Composite Curve Number

Soil/Surface Description	Area (acres)	Soil Group	Curve Number
Woods, Good	0.12	D	77.00
> 75% grass cover, Good	0.04	A	39.00
> 75% grass cover, Good	0.05	D	80.00
> 75% grass cover, Good	0.34	C	74.00
Woods, Good	0.02	C	70.00
Gravel roads	0.04	A	76.00
Gravel roads	0.09	C	89.00
Gravel roads	0.05	D	91.00
Composite Area & Weighted CN	0.75		75.95

Time of Concentration

User-Defined TOC override (minutes): 5

Subbasin Runoff Results

Total Rainfall (in) 5.49
Total Runoff (in) 2.94
Peak Runoff (cfs) 2.30
Weighted Curve Number 75.95
Time of Concentration (days hh:mm:ss) 0 00:05:00

Subbasin : C1-WETLAND

Rainfall Intensity Graph

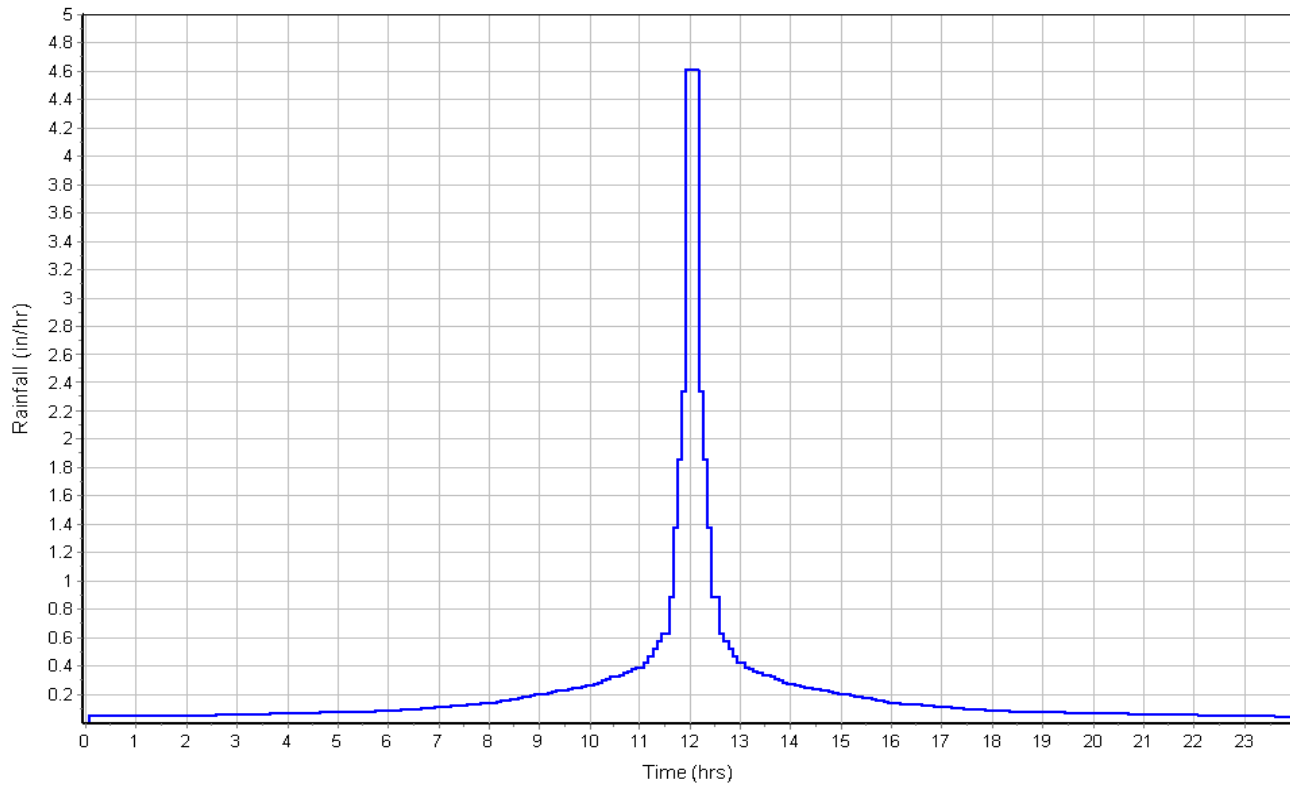

Runoff Hydrograph

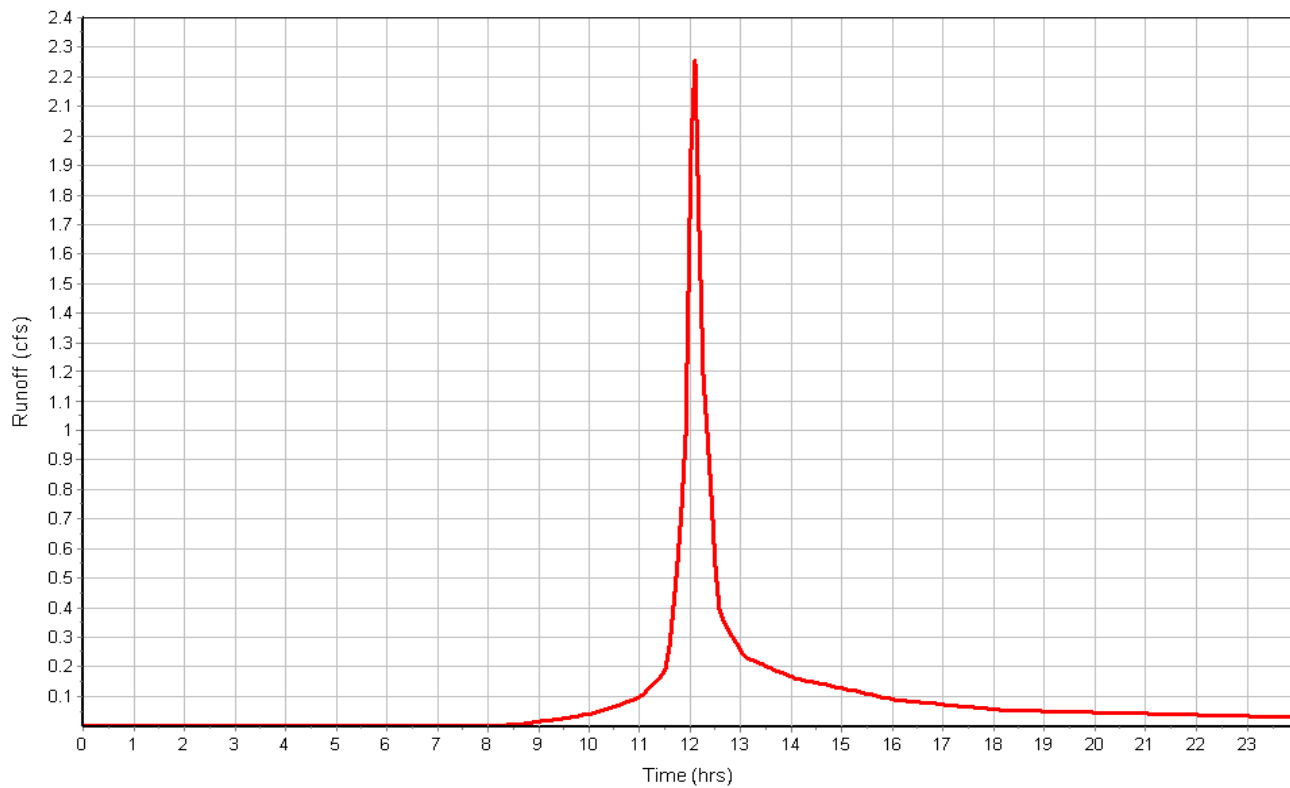

Subbasin : C2-WETLAND

Input Data

Area (ac) 0.73
 Weighted Curve Number 82.63
 Rain Gage ID Rain Gage-01

Composite Curve Number

Soil/Surface Description	Area (acres)	Soil Group	Curve Number
> 75% grass cover, Good	0.31	C	74.00
Gravel roads	0.42	C	89.00
Composite Area & Weighted CN	0.73		82.63

Time of Concentration

Sheet Flow Computations	Subarea	Subarea	Subarea
	A	B	C
Manning's Roughness :	.01	0.00	0.00
Flow Length (ft) :	44	0.00	0.00
Slope (%) :	2	0.00	0.00
2 yr, 24 hr Rainfall (in) :	3.00	0.00	0.00
Velocity (ft/sec) :	1.22	0.00	0.00
Computed Flow Time (min) :	0.60	0.00	0.00

Shallow Concentrated Flow Computations	Subarea	Subarea	Subarea
	A	B	C
Flow Length (ft) :	636	0.00	0.00
Slope (%) :	1.6	0.00	0.00
Surface Type :	Grassed waterway	Unpaved	Unpaved
Velocity (ft/sec) :	1.90	0.00	0.00
Computed Flow Time (min) :	5.58	0.00	0.00

Channel Flow Computations	Subarea	Subarea	Subarea
	A	B	C
Manning's Roughness :	.03	0.00	0.00
Flow Length (ft) :	2256	0.00	0.00
Channel Slope (%) :	.5	0.00	0.00
Cross Section Area (ft ²) :	2.475	0.00	0.00
Wetted Perimeter (ft) :	6.91	0.00	0.00
Velocity (ft/sec) :	1.77	0.00	0.00
Computed Flow Time (min) :	21.23	0.00	0.00
Total TOC (min)	27.41		

Subbasin Runoff Results

Total Rainfall (in) 5.49
 Total Runoff (in) 3.58
 Peak Runoff (cfs) 1.82
 Weighted Curve Number 82.63
 Time of Concentration (days hh:mm:ss) 0 00:27:25

Subbasin : C2-WETLAND

Rainfall Intensity Graph

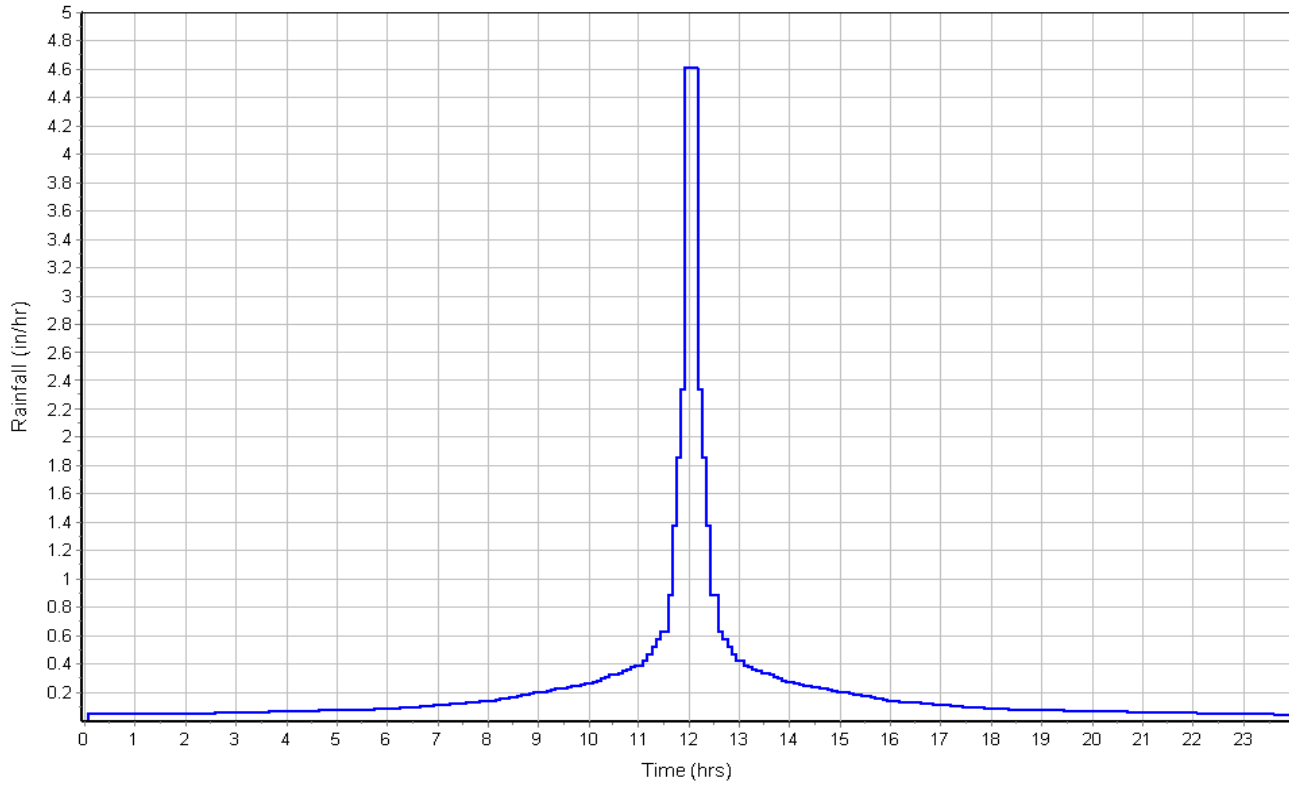

Runoff Hydrograph

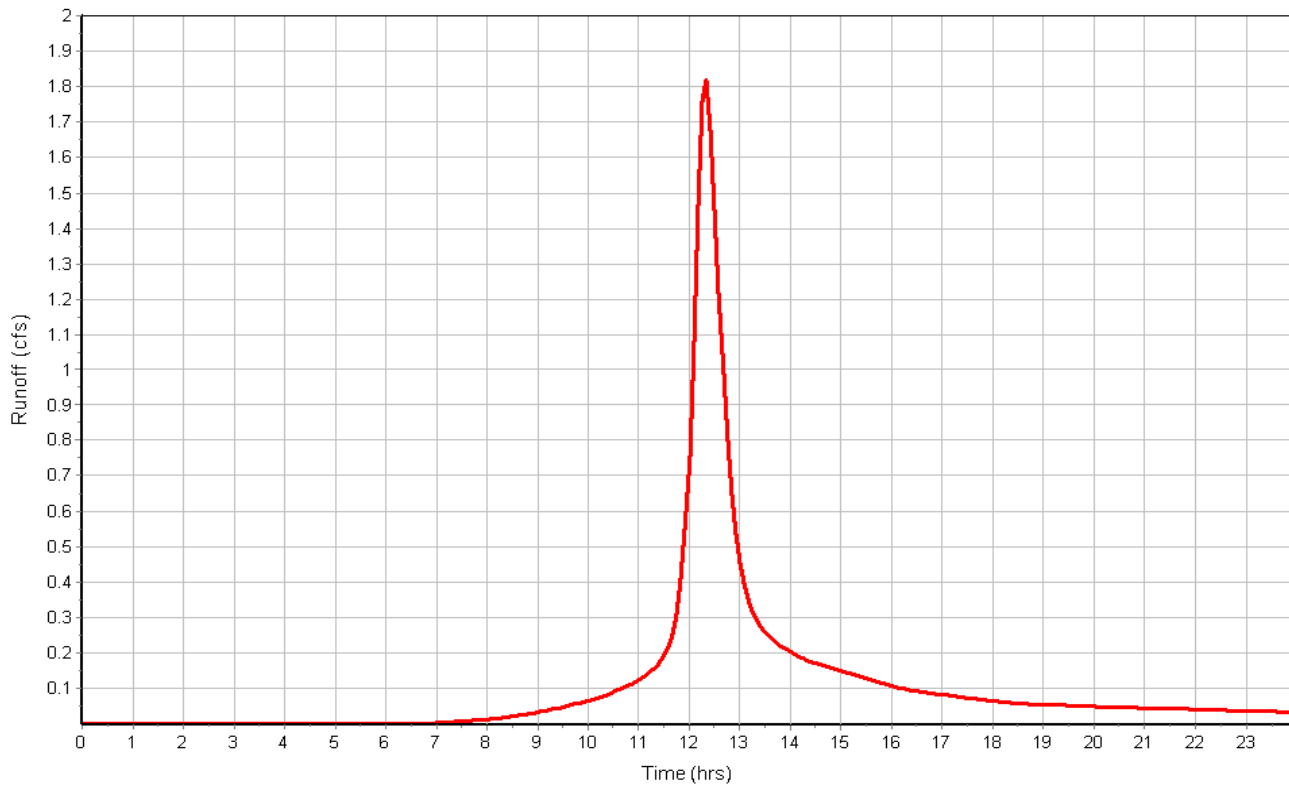

Subbasin : C3-BYPASS

Input Data

Area (ac) 21.22
 Weighted Curve Number 71.79
 Rain Gage ID Rain Gage-01

Composite Curve Number

Soil/Surface Description	Area (acres)	Soil Group	Curve Number
> 75% grass cover, Good	0.01	D	80.00
Woods, Good	12.33	C	70.00
Woods, Good	7.45	D	77.00
> 75% grass cover, Good	0.66	A	39.00
> 75% grass cover, Good	0.57	C	74.00
Gravel roads	0.20	C	89.00
Composite Area & Weighted CN	21.22		71.79

Time of Concentration

	Subarea	Subarea	Subarea
	A	B	C
Sheet Flow Computations			
Manning's Roughness :	.6	0.00	0.00
Flow Length (ft) :	100	0.00	0.00
Slope (%) :	.47	0.00	0.00
2 yr, 24 hr Rainfall (in) :	3.00	0.00	0.00
Velocity (ft/sec) :	0.03	0.00	0.00
Computed Flow Time (min) :	54.75	0.00	0.00
Shallow Concentrated Flow Computations			
Flow Length (ft) :	2140	0.00	0.00
Slope (%) :	.47	0.00	0.00
Surface Type :	Grassed waterway	Unpaved	Unpaved
Velocity (ft/sec) :	1.03	0.00	0.00
Computed Flow Time (min) :	34.63	0.00	0.00
Total TOC (min)	89.38		

Subbasin Runoff Results

Total Rainfall (in) 5.49
 Total Runoff (in) 2.56
 Peak Runoff (cfs) 19.95
 Weighted Curve Number 71.79
 Time of Concentration (days hh:mm:ss) 0 01:29:23

Subbasin : C3-BYPASS

Rainfall Intensity Graph

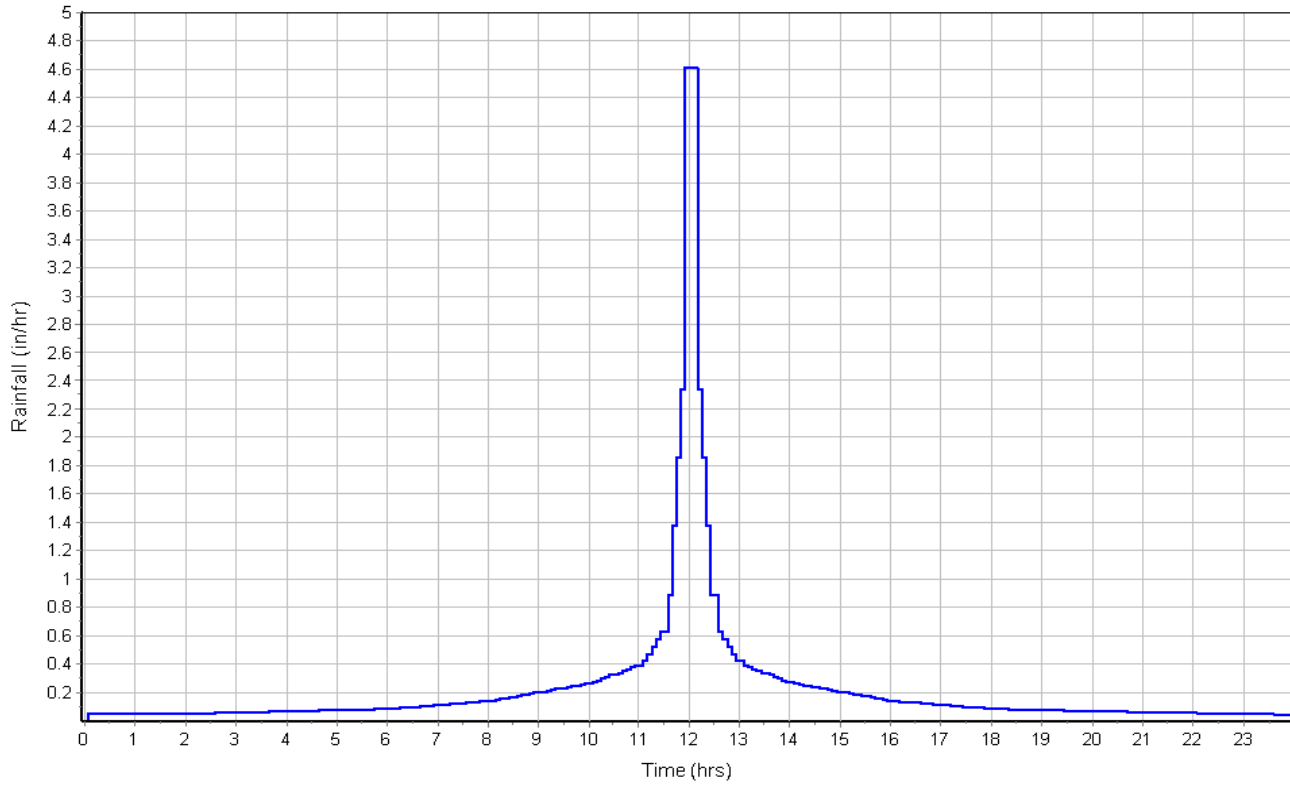

Runoff Hydrograph

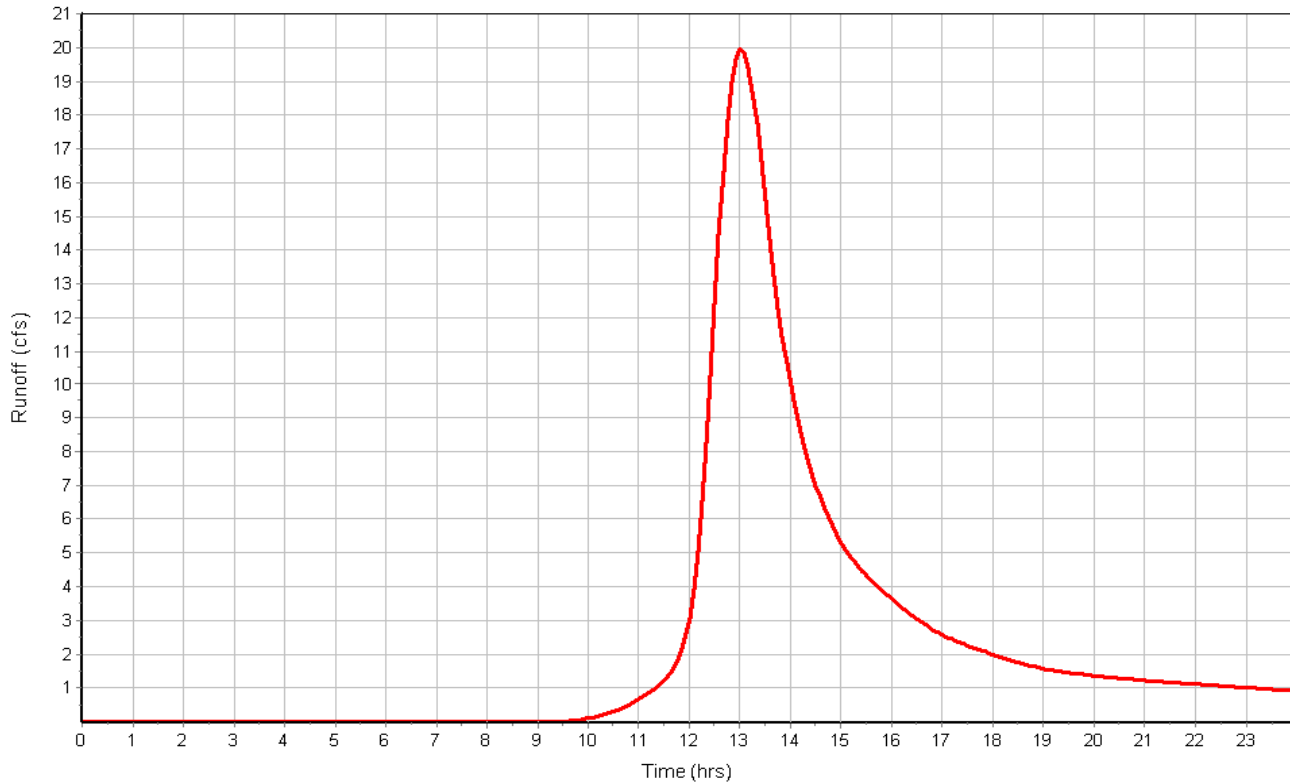

Subbasin : D

Input Data

Area (ac) 0.69
 Weighted Curve Number 77.00
 Rain Gage ID Rain Gage-01

Composite Curve Number

Soil/Surface Description	Area (acres)	Soil Group	Curve Number
Woods, Good	0.74	D	77.00
Composite Area & Weighted CN	0.74		77.00

Time of Concentration

Sheet Flow Computations	Subarea	Subarea	Subarea
	A	B	C
Manning's Roughness :	.6	0.00	0.00
Flow Length (ft) :	100	0.00	0.00
Slope (%) :	21	0.00	0.00
2 yr, 24 hr Rainfall (in) :	3.00	0.00	0.00
Velocity (ft/sec) :	0.14	0.00	0.00
Computed Flow Time (min) :	11.98	0.00	0.00

Shallow Concentrated Flow Computations	Subarea	Subarea	Subarea
	A	B	C
Flow Length (ft) :	16	0.00	0.00
Slope (%) :	14.5	0.00	0.00
Surface Type :	Woodland	Unpaved	Unpaved
Velocity (ft/sec) :	1.90	0.00	0.00
Computed Flow Time (min) :	0.14	0.00	0.00
Total TOC (min)	12.12		

Subbasin Runoff Results

Total Rainfall (in) 5.49
 Total Runoff (in) 3.04
 Peak Runoff (cfs) 1.93
 Weighted Curve Number 77.00
 Time of Concentration (days hh:mm:ss) 0 00:12:07

Subbasin : D

Rainfall Intensity Graph

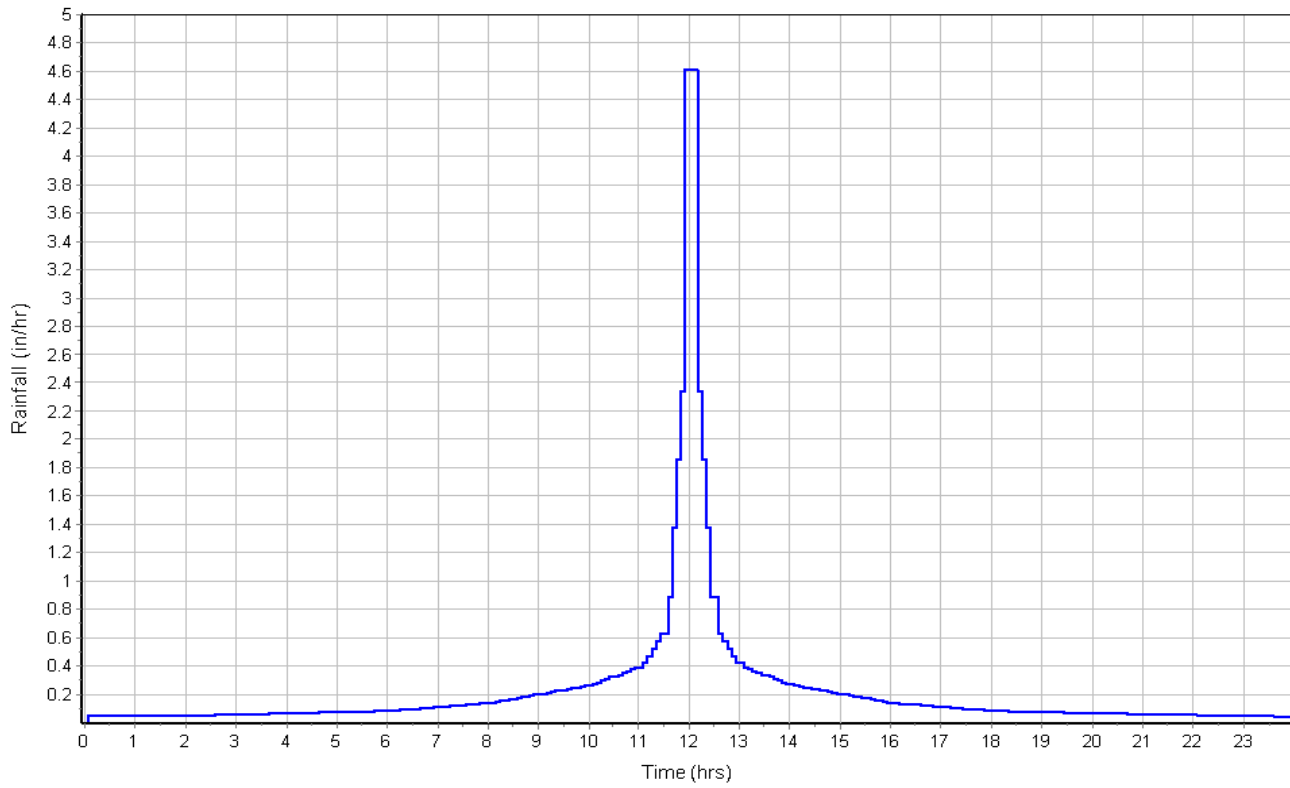

Runoff Hydrograph

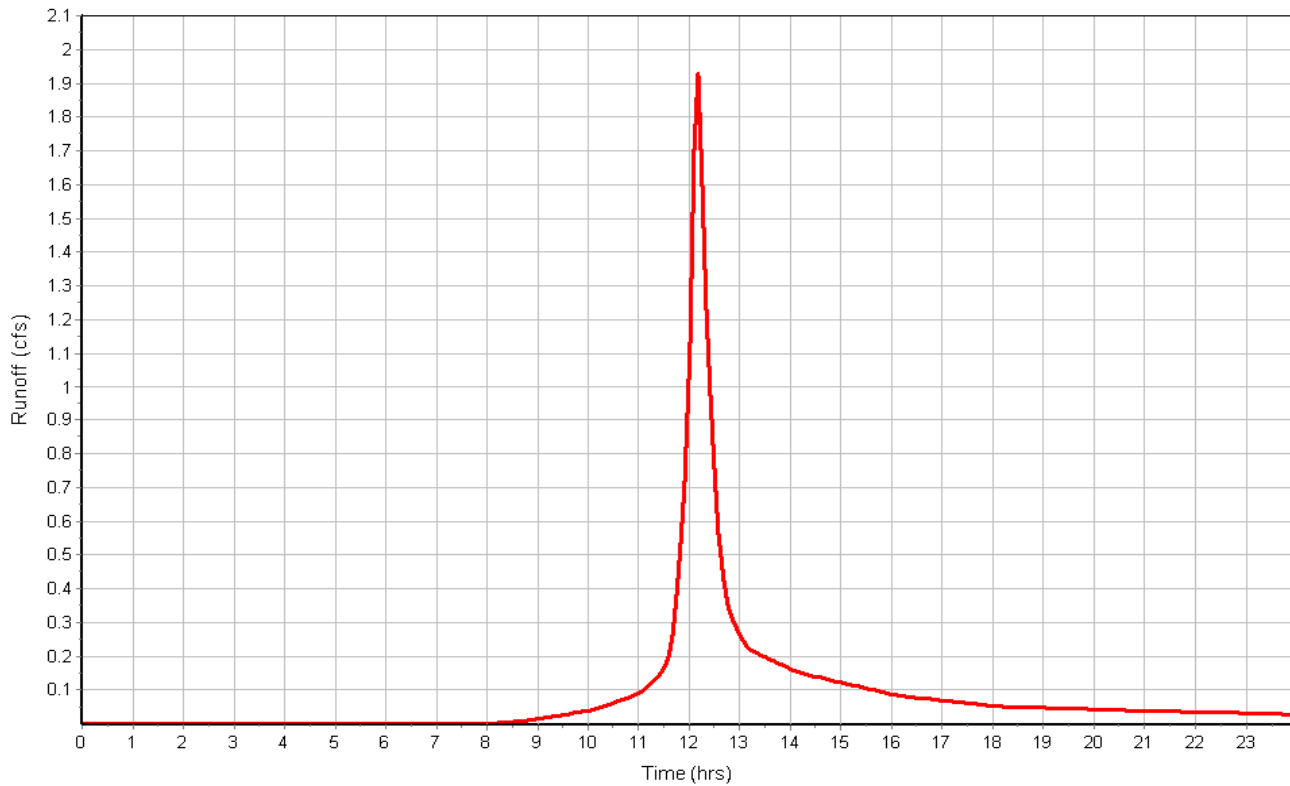

Subbasin : E

Input Data

Area (ac) 2.96
 Weighted Curve Number 77.00
 Rain Gage ID Rain Gage-01

Composite Curve Number

Soil/Surface Description	Area (acres)	Soil Group	Curve Number
Woods, Good	2.96	D	77.00
Composite Area & Weighted CN	2.96		77.00

Time of Concentration

Sheet Flow Computations	Subarea	Subarea	Subarea
	A	B	C
Manning's Roughness :	.6	0.00	0.00
Flow Length (ft) :	100	0.00	0.00
Slope (%) :	24	0.00	0.00
2 yr, 24 hr Rainfall (in) :	3.00	0.00	0.00
Velocity (ft/sec) :	0.15	0.00	0.00
Computed Flow Time (min) :	11.35	0.00	0.00

Shallow Concentrated Flow Computations	Subarea	Subarea	Subarea
	A	B	C
Flow Length (ft) :	227	0.00	0.00
Slope (%) :	18	0.00	0.00
Surface Type :	Woodland	Unpaved	Unpaved
Velocity (ft/sec) :	2.12	0.00	0.00
Computed Flow Time (min) :	1.78	0.00	0.00
Total TOC (min)	13.14		

Subbasin Runoff Results

Total Rainfall (in) 5.49
 Total Runoff (in) 3.04
 Peak Runoff (cfs) 8.13
 Weighted Curve Number 77.00
 Time of Concentration (days hh:mm:ss) 0 00:13:08

Subbasin : E

Rainfall Intensity Graph

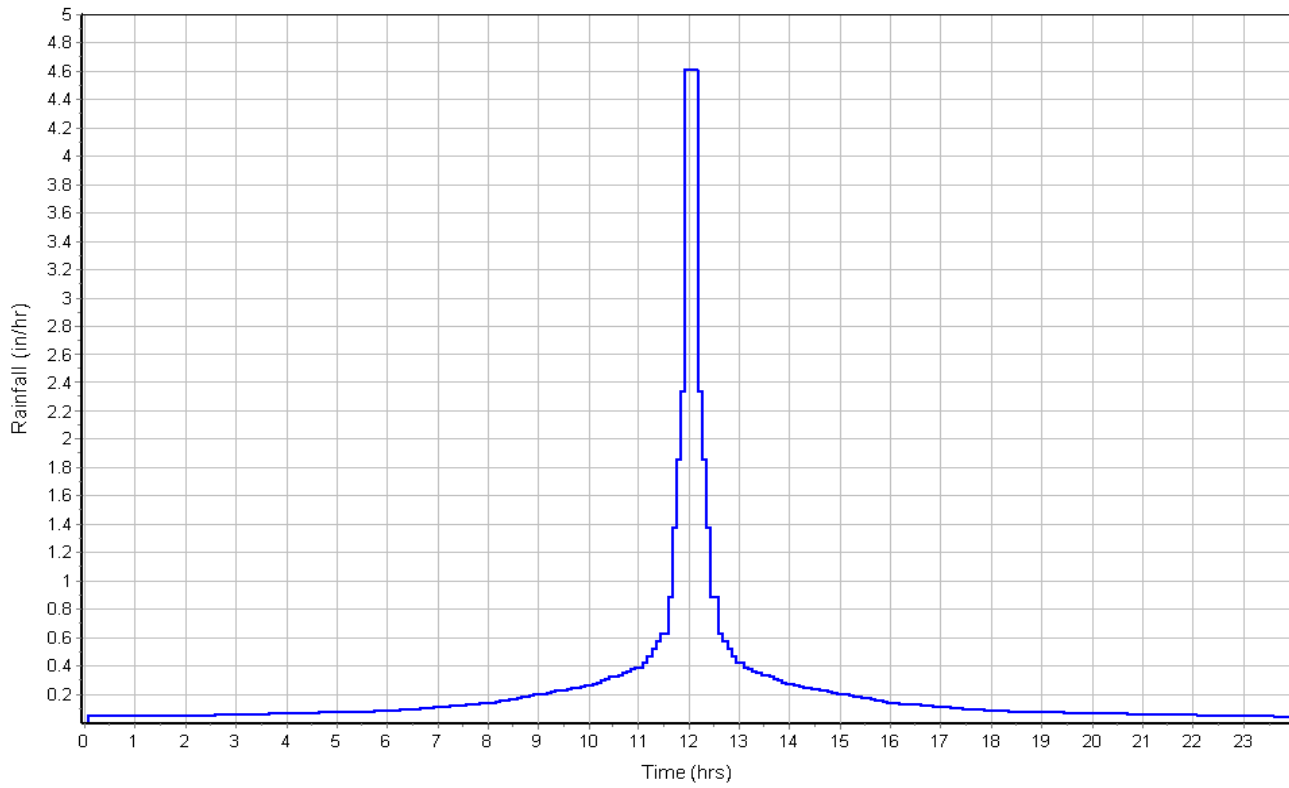

Runoff Hydrograph

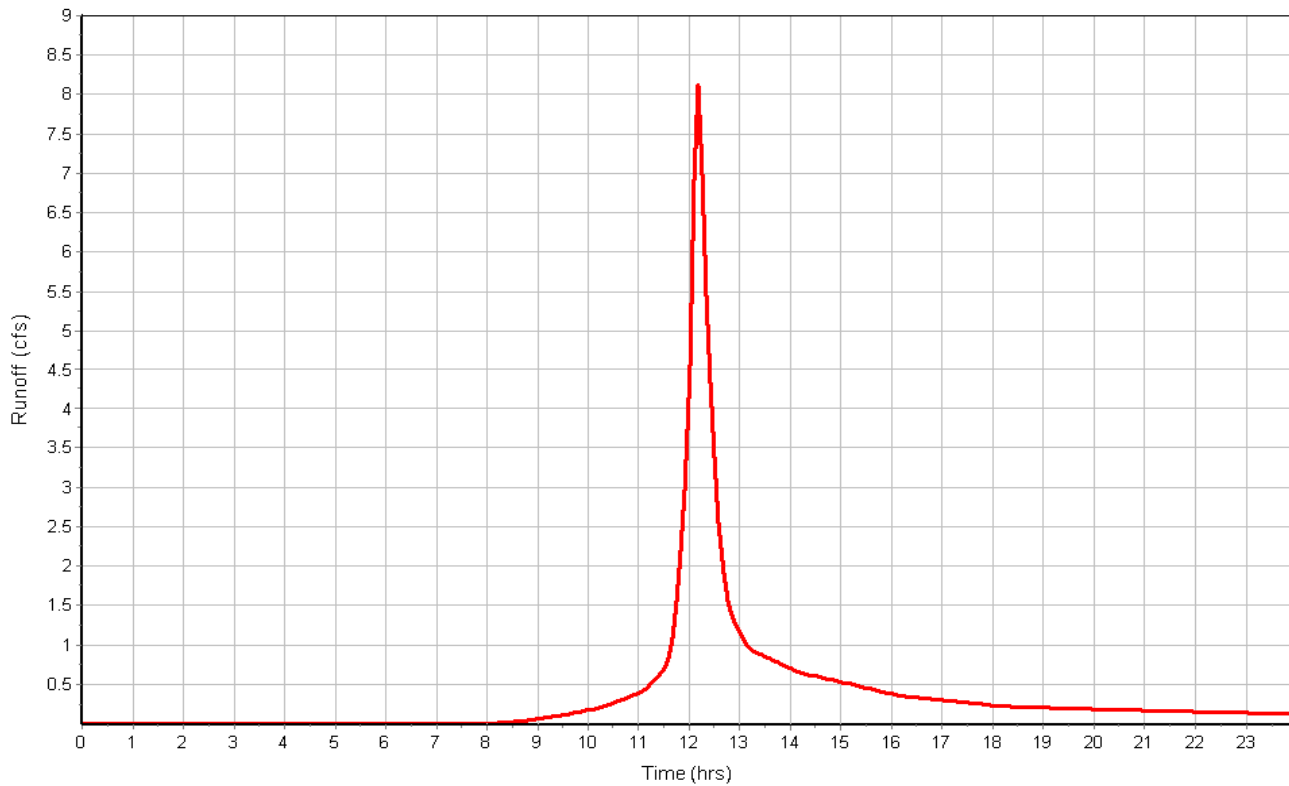

Junction Input

Element ID	Invert Elevation (ft)	Ground/Rim (Max) Elevation (ft)
CB1	305.30	310.33
CB2	312.00	316.00
END-SECTION-C1	308.00	6.00
END-SECTION-C2	308.00	6.00
OUTLET-STR-A2	305.60	312.00
OUTLET-STR-C1	308.10	312.00
OUTLET-STR-C2	308.10	312.00

Junction Results

Element ID	Peak Inflow	Max HGL Elevation Attained	Max HGL Depth Attained	Min Freeboard Attained	Average HGL Elevation Attained	Time of Max HGL Occurrence
	(cfs)	(ft)	(ft)	(ft)	(ft)	(days hh:mm)
CB1	14.63	306.96	1.66	3.37	305.63	0 12:30
CB2	20.08	313.28	1.28	2.72	312.18	0 12:15
END-SECTION-C1	0.17	308.08	0.08	3.15	308.07	0 14:04
END-SECTION-C2	0.05	308.08	0.08	3.15	308.07	0 20:30
OUTLET-STR-A2	9.20	306.67	1.07	5.33	305.82	0 12:20
OUTLET-STR-C1	0.03	308.18	0.08	3.82	308.17	0 14:04
OUTLET-STR-C2	0.03	308.18	0.08	3.82	308.17	0 20:30

Pipe Input

Element ID	Length (ft)	Inlet Invert Elevation (ft)	Outlet Invert Elevation (ft)	Average Pipe Slope (%)	Pipe Shape	Pipe Diameter or Height (in)	Pipe Width (in)	Manning's Roughness
CULV-A	98.00	305.30	305.12	0.1800	CIRCULAR	36.000	36.000	0.0150
CULV-A2-1	104.00	312.00	310.00	1.9200	CIRCULAR	24.000	24.000	0.0150
CULV-A2-2	43.00	305.60	305.30	0.7000	CIRCULAR	24.000	24.000	0.0150
CULV-C1	30.00	308.10	308.00	0.3300	CIRCULAR	12.000	12.000	0.0130
CULV-C2	30.00	308.10	308.00	0.3300	CIRCULAR	12.000	12.000	0.0130

Pipe Results

Element ID	Peak Flow	Time of Peak Flow Occurrence	Design Flow Capacity	Peak Flow Velocity	Peak Flow Depth
	(cfs)	(days hh:mm)	(cfs)	(ft/sec)	(ft)
CULV-A	14.63	0 12:31	24.77	3.65	1.66
CULV-A2-1	20.01	0 12:15	27.19	9.48	1.28
CULV-A2-2	9.20	0 12:20	16.38	5.36	1.07
CULV-C1	0.03	0 14:04	2.06	0.90	0.08
CULV-C2	0.03	0 20:30	2.06	0.91	0.08

Storage Nodes

Storage Node : DETENTION-A

Input Data

Invert Elevation (ft) 309.50
Max (Rim) Elevation (ft) 312.00
Max (Rim) Offset (ft) 2.50
Initial Water Elevation (ft) 309.50
Initial Water Depth (ft) 0.00
Ponded Area (ft²) 0.00
Evaporation Loss 0.00

Storage Area Volume Curves

Storage Curve : Storage-08

Stage (ft)	Storage Area (ft ²)	Storage Volume (ft ³)
0	113	0.000
.5	15327	3860.00
1.2	18183.	15588.50
1.5	18635	21111.20
2.5	22257	41557.20

Storage Area Volume Curves

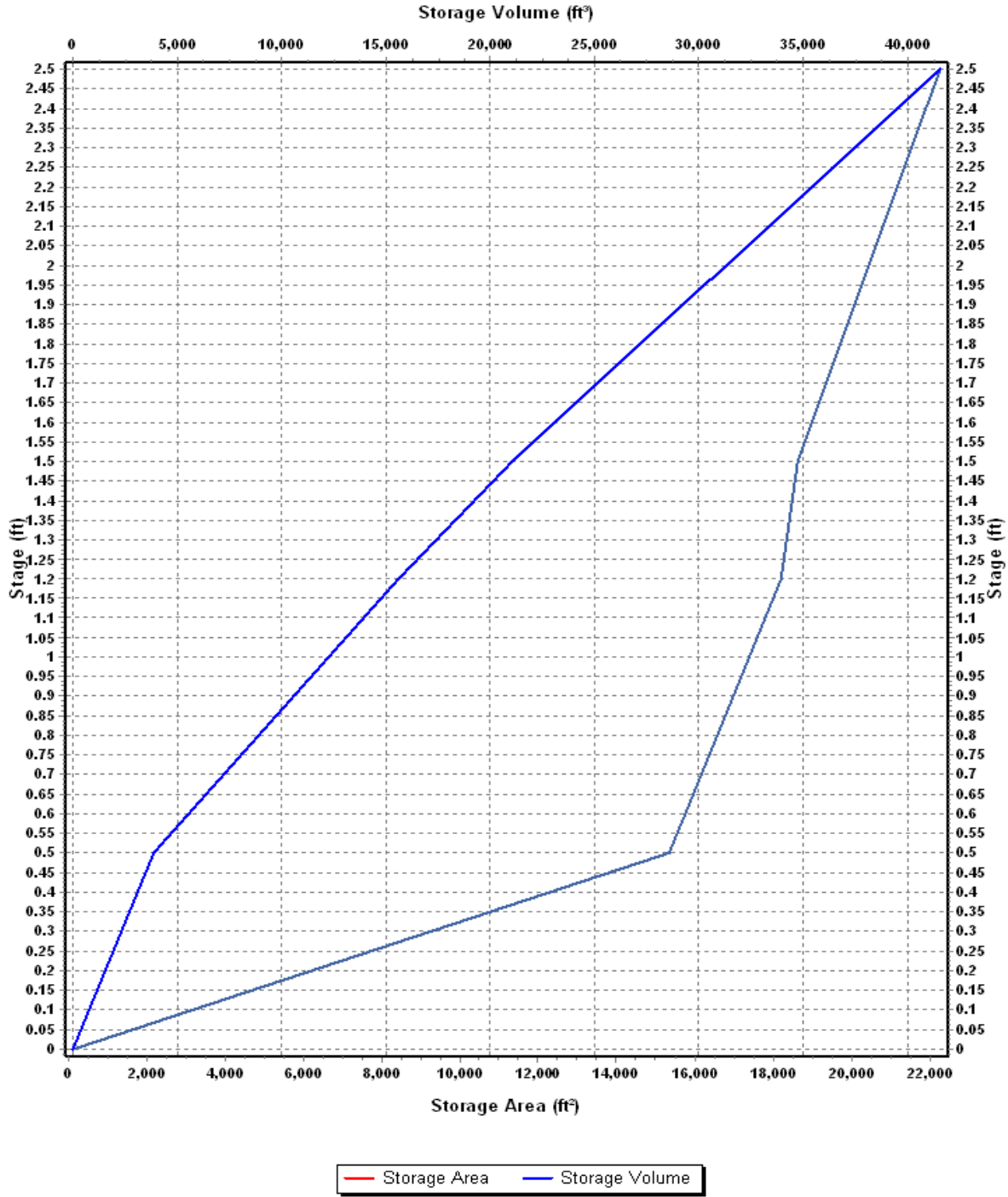

Storage Node : DETENTION-A (continued)

Outflow Orifices

Element ID	Orifice Type	Orifice Shape	Circular Orifice Diameter (in)	Rectangular Orifice Height (in)	Rectangular Orifice Width (in)	Orifice Invert Elevation (ft)	Orifice Coefficient
BEEHIVE-GRATE	Bottom	CIRCULAR	18.17			310.33	0.61
ORIF-DET-A	Side	Rectangular		4.00	36.00	309.50	0.63

Output Summary Results

Peak Inflow (cfs)	14.79
Peak Lateral Inflow (cfs)	9.67
Peak Outflow (cfs)	5.67
Peak Exfiltration Flow Rate (cfm)	0.00
Max HGL Elevation Attained (ft)	310.50
Max HGL Depth Attained (ft)	1
Average HGL Elevation Attained (ft)	309.61
Average HGL Depth Attained (ft)	0.11
Time of Max HGL Occurrence (days hh:mm)	0 12:32
Total Exfiltration Volume (1000-ft ³)	0.000
Total Flooded Volume (ac-in)	0
Total Time Flooded (min)	0
Total Retention Time (sec)	0.00

Storage Node : FILTER-A2

Input Data

Invert Elevation (ft)	308.00
Max (Rim) Elevation (ft)	312.00
Max (Rim) Offset (ft)	4.00
Initial Water Elevation (ft)	309.00
Initial Water Depth (ft)	1.00
Ponded Area (ft ²)	0.00
Evaporation Loss	0.00

Storage Area Volume Curves

Storage Curve : Storage-05

Stage (ft)	Storage Area (ft ²)	Storage Volume (ft ³)
0	2178	0.000
1	5898	4038.00
2	7084	10529.00
3	8421	18281.50
4	9818	27401.00

Storage Area Volume Curves

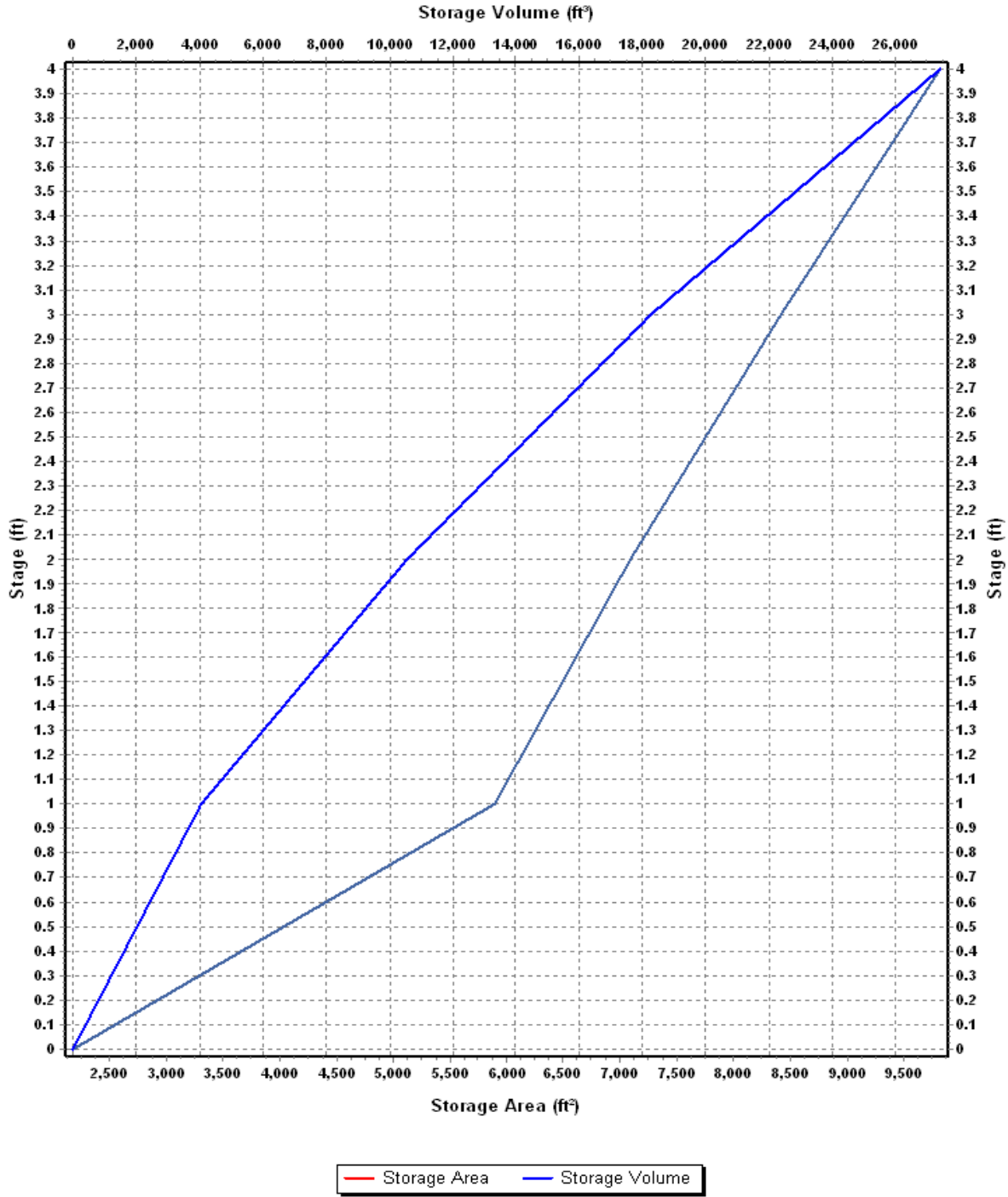

Storage Node : FILTER-A2 (continued)

Outflow Weirs

Element ID	Weir Type	Crest Elevation (ft)	Length (ft)	Weir Total Height (ft)	Discharge Coefficient
SPILLWAY-A2	Trapezoidal	310.70	55.00	1.30	3.10

Outflow Orifices

Element ID	Orifice Type	Orifice Shape	Circular Orifice Diameter (in)	Rectangular Orifice Height (in)	Rectangular Orifice Width (in)	Orifice Invert Elevation (ft)	Orifice Coefficient
ORIF-A2	Side	Rectangular		6.00	35.00	309.00	0.63

Output Summary Results

Peak Inflow (cfs)	20.01
Peak Lateral Inflow (cfs)	0.00
Peak Outflow (cfs)	16.81
Peak Exfiltration Flow Rate (cfm)	0.00
Max HGL Elevation Attained (ft)	310.83
Max HGL Depth Attained (ft)	2.83
Average HGL Elevation Attained (ft)	309.17
Average HGL Depth Attained (ft)	1.17
Time of Max HGL Occurrence (days hh:mm)	0 12:20
Total Exfiltration Volume (1000-ft ³)	0.000
Total Flooded Volume (ac-in)	0
Total Time Flooded (min)	0
Total Retention Time (sec)	0.00

Storage Node : WETLAND-C1

Input Data

Invert Elevation (ft)	308.77
Max (Rim) Elevation (ft)	312.00
Max (Rim) Offset (ft)	3.23
Initial Water Elevation (ft)	309.33
Initial Water Depth (ft)	0.56
Ponded Area (ft ²)	0.00
Evaporation Loss	0.00

Storage Area Volume Curves

Storage Curve : Storage-09

Stage (ft)	Storage Area (ft ²)	Storage Volume (ft ³)
0	2183	0.000
.57	2815	1424.43
1.33	3441	3801.71
2.33	4347	7695.71
3.33	5324	12531.21

Storage Area Volume Curves

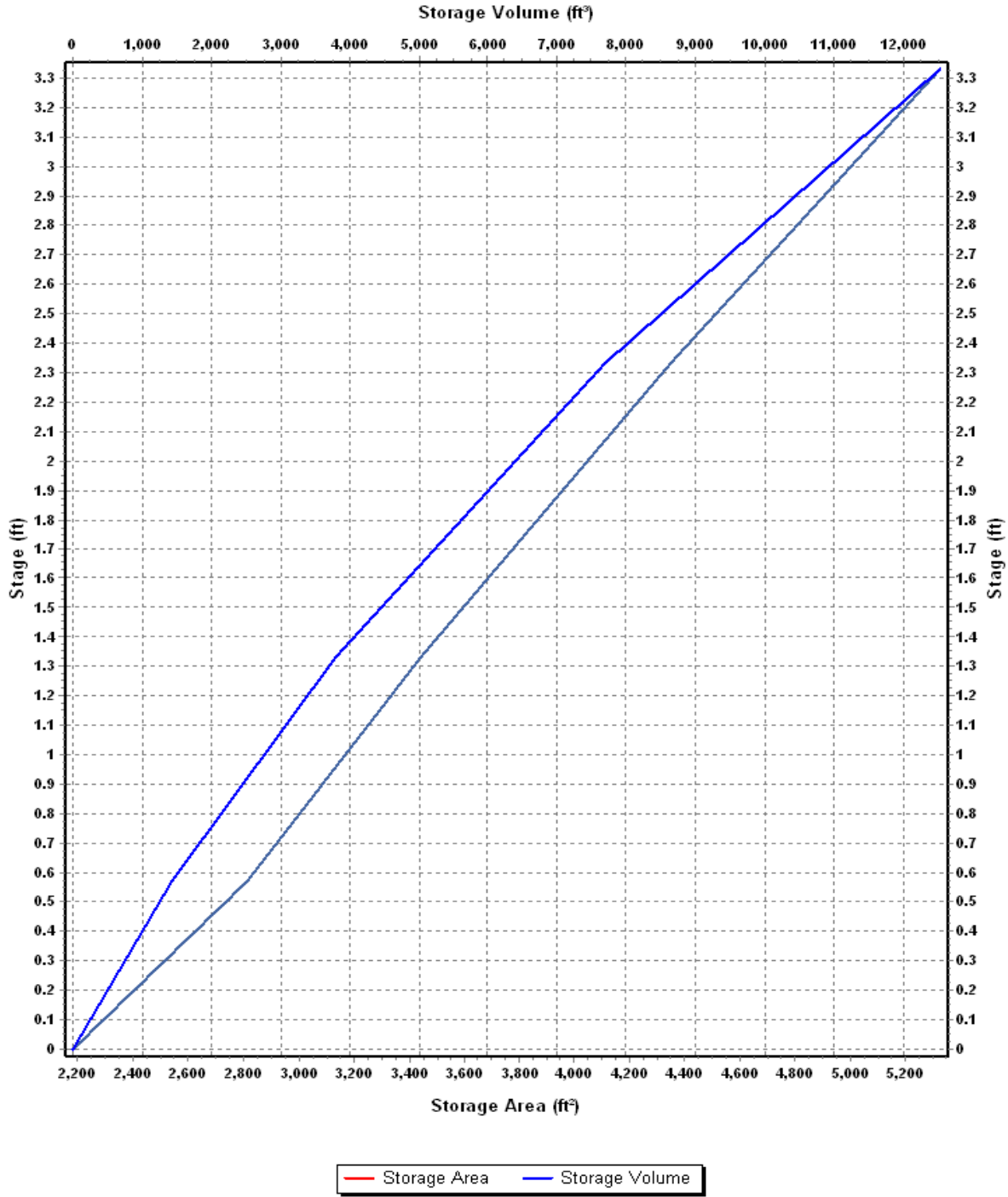

Storage Node : WETLAND-C1 (continued)

Outflow Weirs

Element ID	Weir Type	Crest Elevation (ft)	Length (ft)	Weir Total Height (ft)	Discharge Coefficient
SPILLWAY-C1	Trapezoidal	310.70	10.00	1.30	3.33

Outflow Orifices

Element ID	Orifice Type	Orifice Shape	Circular Orifice Diameter (in)	Rectangular Orifice Height (in)	Rectangular Orifice Width (in)	Orifice Invert Elevation (ft)	Orifice Coefficient
ORIF-C1	Side	CIRCULAR	0.83			308.10	0.61

Output Summary Results

Peak Inflow (cfs)	2.26
Peak Lateral Inflow (cfs)	2.26
Peak Outflow (cfs)	0.17
Peak Exfiltration Flow Rate (cfm)	0.00
Max HGL Elevation Attained (ft)	310.73
Max HGL Depth Attained (ft)	1.96
Average HGL Elevation Attained (ft)	309.97
Average HGL Depth Attained (ft)	1.2
Time of Max HGL Occurrence (days hh:mm)	0 14:04
Total Exfiltration Volume (1000-ft ³)	0.000
Total Flooded Volume (ac-in)	0
Total Time Flooded (min)	0
Total Retention Time (sec)	0.00

Storage Node : WETLAND-C2

Input Data

Invert Elevation (ft)	308.77
Max (Rim) Elevation (ft)	312.00
Max (Rim) Offset (ft)	3.23
Initial Water Elevation (ft)	309.42
Initial Water Depth (ft)	0.65
Ponded Area (ft ²)	0.00
Evaporation Loss	0.00

Storage Area Volume Curves

Storage Curve : Storage-07

Stage (ft)	Storage Area (ft ²)	Storage Volume (ft ³)
0	2828	0.000
.57	3522	1809.75
1.23	5207	4690.32
2.33	7549	11706.12
3.33	8345	19653.12

Storage Area Volume Curves

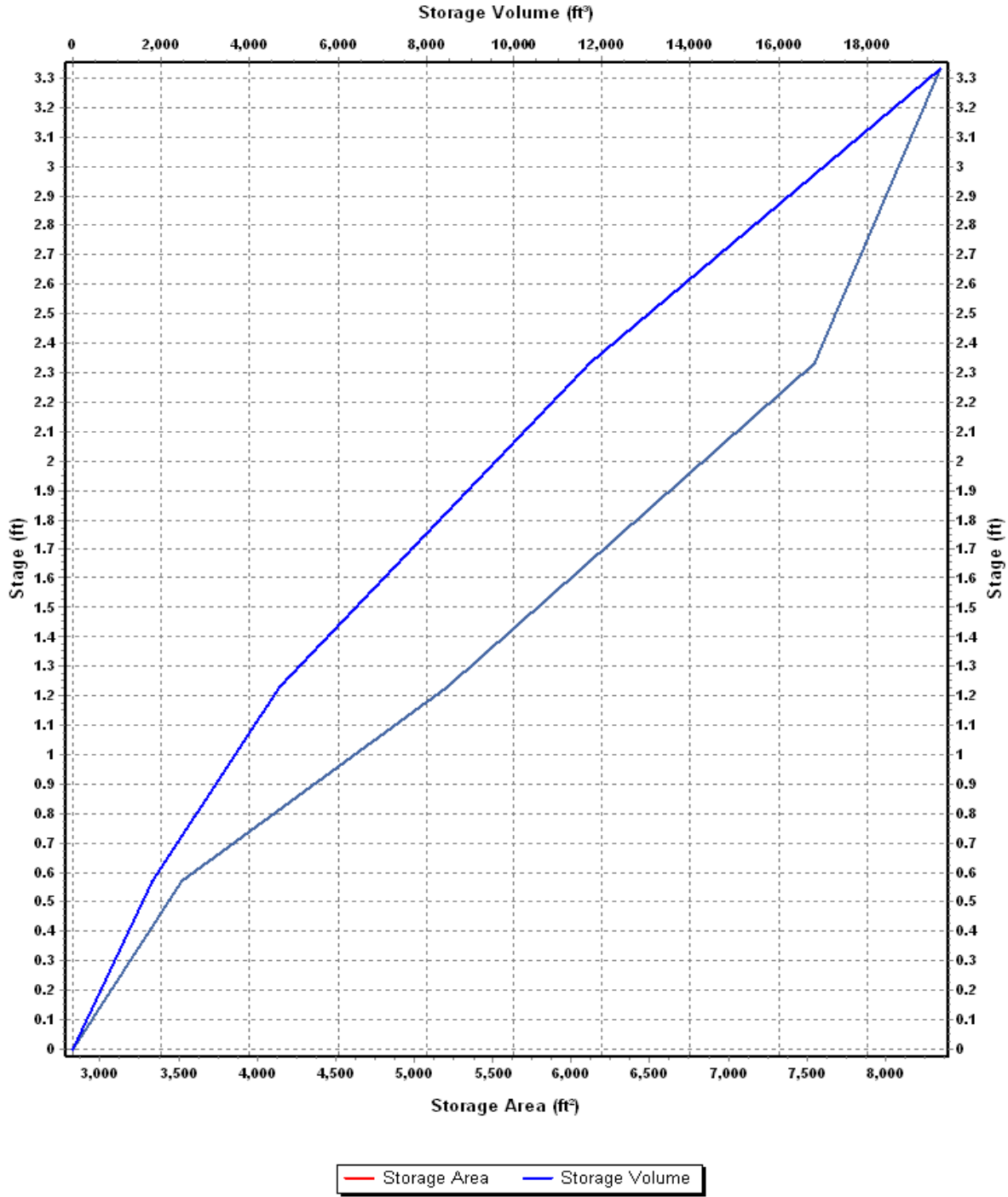

Storage Node : WETLAND-C2 (continued)

Outflow Weirs

Element ID	Weir Type	Crest Elevation (ft)	Length (ft)	Weir Total Height (ft)	Discharge Coefficient
SPILLWAY-C2	Trapezoidal	310.80	10.00	1.20	3.10

Outflow Orifices

Element ID	Orifice Type	Orifice Shape	Circular Orifice Diameter (in)	Rectangular Orifice Height (in)	Rectangular Orifice Width (in)	Orifice Invert Elevation (ft)	Orifice Coefficient
ORIF-C2A	Side	CIRCULAR	0.83			308.10	0.61

Output Summary Results

Peak Inflow (cfs)	1.82
Peak Lateral Inflow (cfs)	1.82
Peak Outflow (cfs)	0.05
Peak Exfiltration Flow Rate (cfm)	0.00
Max HGL Elevation Attained (ft)	310.81
Max HGL Depth Attained (ft)	2.04
Average HGL Elevation Attained (ft)	310.03
Average HGL Depth Attained (ft)	1.26
Time of Max HGL Occurrence (days hh:mm)	0 20:30
Total Exfiltration Volume (1000-ft ³)	0.000
Total Flooded Volume (ac-in)	0
Total Time Flooded (min)	0
Total Retention Time (sec)	0.00

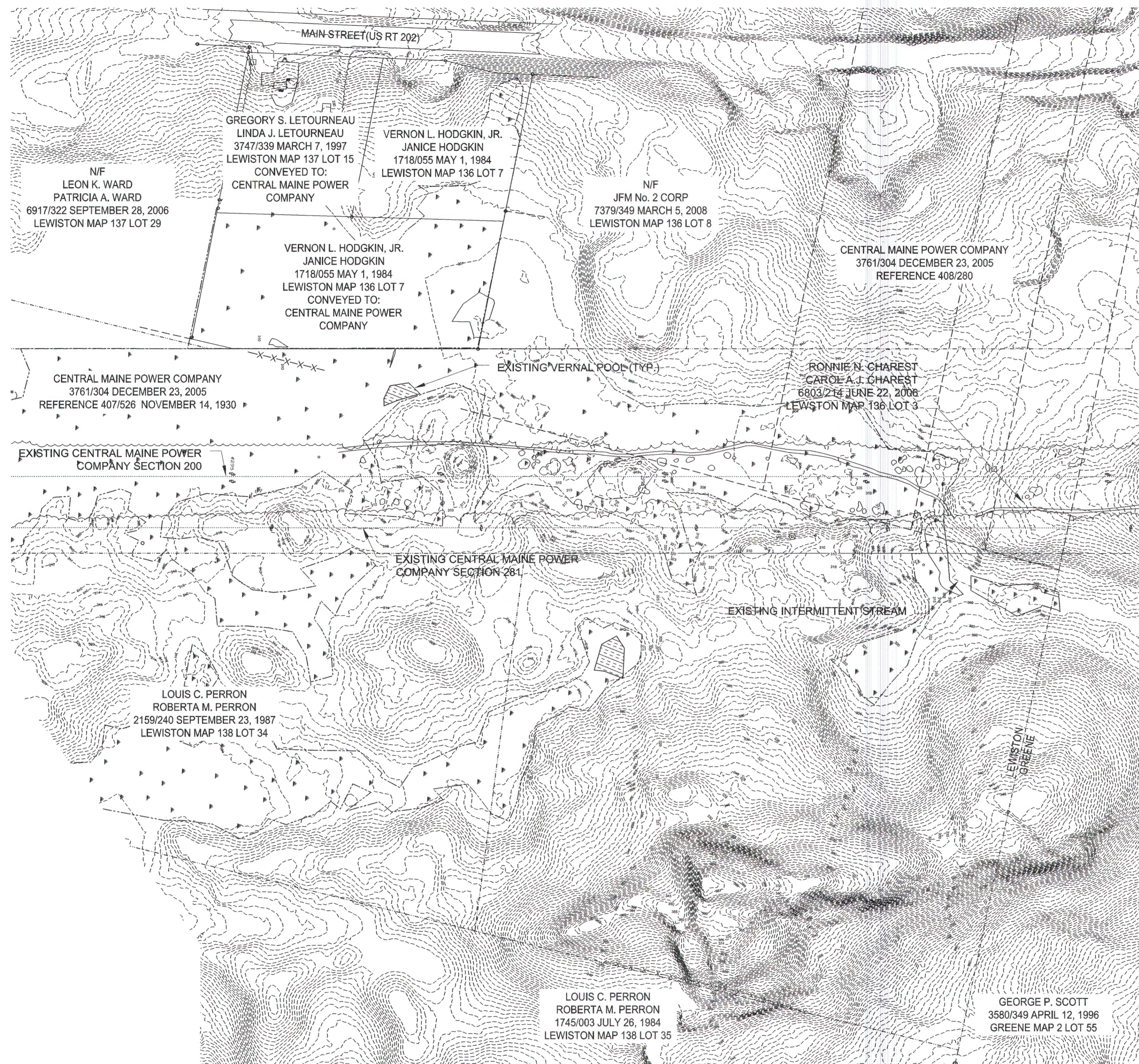
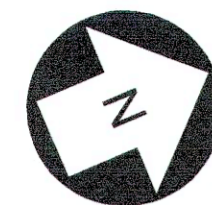

LEGEND

- 309 --- EXISTING CONTOUR
- x x x --- EXISTING EDGE OF PAVEMENT
- x x x --- EXISTING FENCE LINE
- x x x --- EXISTING ROCK OR EXPOSED LEDGE
- x x x --- EXISTING SPOIL PILE
- x x x --- EXISTING TREE LINE
- x x x --- EXISTING TRANSMISSION RIGHT-OF-WAY
- x x x --- EXISTING STREAM
- x x x --- EXISTING UTILITY POLE/OH LINE
- x x x --- EXISTING WETLAND BOUNDARY
- x x x --- EXISTING BUILDING
- x x x --- PROPOSED CONTOUR
- x x x --- PROPOSED EDGE OF GRAVEL
- x x x --- PROPOSED FENCE LINE
- x x x --- PROPOSED EDGE GRAVEL YARD SURFACE
- x x x --- PROPOSED SITE LAYOUT POINT
- x x x --- PROPOSED TREE LINE
- x x x --- PROPOSED SILT FENCE
- x x x --- PROPERTY LINE
- x x x --- PROPOSED CHECK DAM

NOTES:

1. TOPOGRAPHIC SURVEY PERFORMED BY SACKETT & BRAKE SURVEY, INC. DATED JUNE 12, 2017 AND JUNE 18, 2018. HORIZONTAL DATUM - NAD83 MAINE STATE PLANE COORDINATE SYSTEM, WEST ZONE, US SURVEY FEET, VERTICAL DATUM-NAVD88 FEET.
2. ADDITIONAL TRANSMISSION LINE REFERENCE DRAWINGS, 1011-T200-24 AND 1011-T251-023.

GENERAL SITE PLAN
SCALE: 1"= 120'

ISSUED FOR PERMITTING
NOT FOR CONSTRUCTION
07/12/18

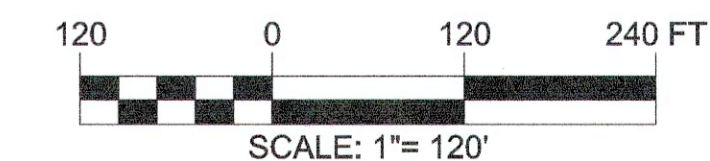

REV.	DESCRIPTION	DATE	BY	CK	APP	OWNER ENGINEER:	APPROVAL STAMP:	PE Stamp	CONFIDENTIAL, PROPRIETARY and TRADE SECRET INFORMATION	MERRILL ROAD/1076	LEWISTON, ME
B	ACCESS ROAD ALIGNMENT REVISIONS	07/12/18	RST	KRV					Property of Iberdrola, USA	SH 1 OF 2	
						DRAWING PREPARED BY:	ACCEPTED BY OE:			NO.	1076-003-001
										SCALE: 1"=120'	FILE: 1076-003-001SH001.DWG
										DATE:	REV. B

ANSI D CADD Drawing. DO NOT REVISE MANUALLY.

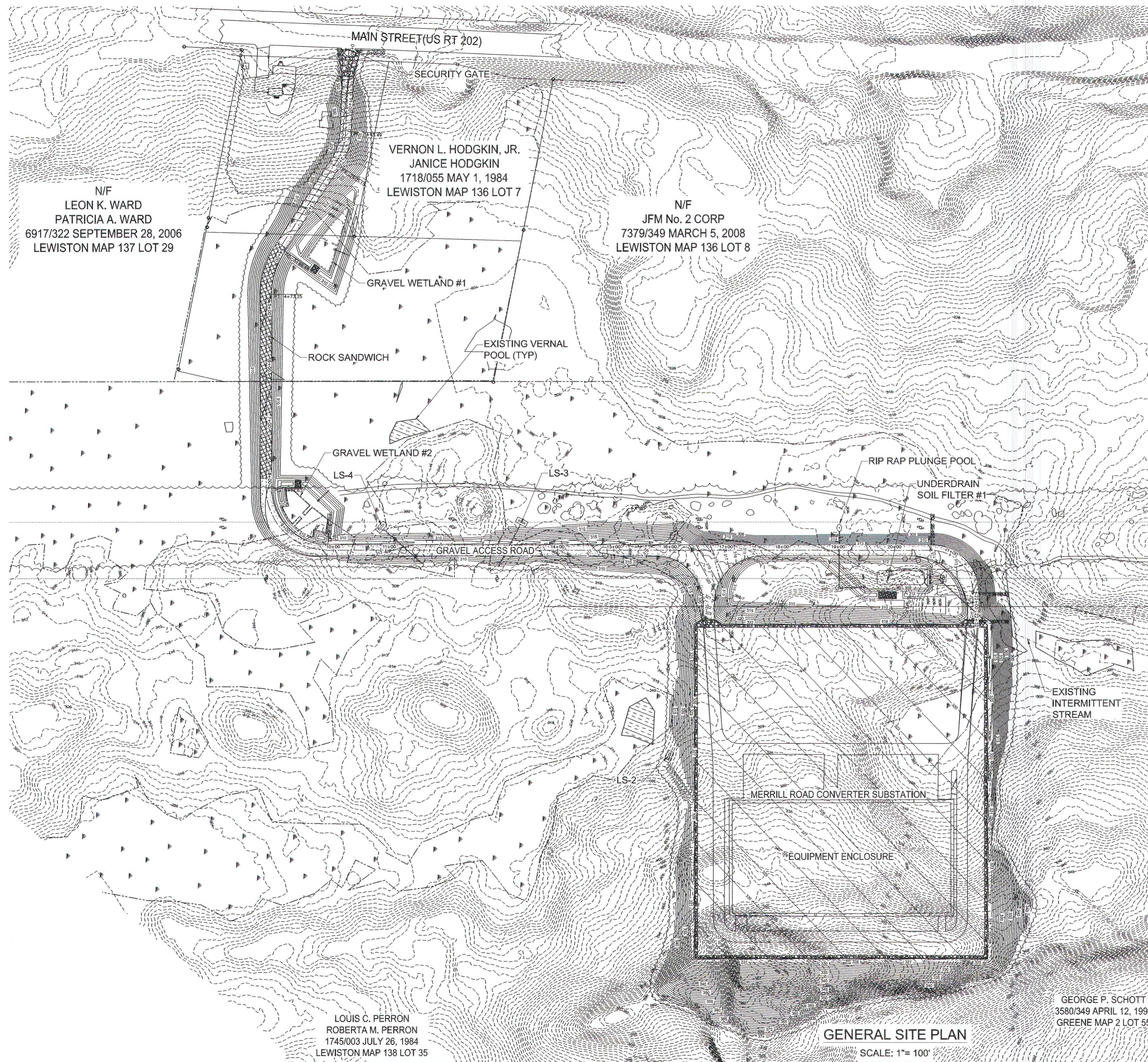
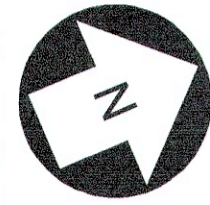

LEGEND

- 309 --- EXISTING CONTOUR
- EXISTING EDGE OF PAVEMENT
- X- EXISTING FENCE LINE
- █ EXISTING ROCK OR EXPOSED LEDGE
- █ EXISTING SPOIL PILE
- EXISTING TREE LINE
- EXISTING TRANSMISSION RIGHT-OF-WAY
- EXISTING STREAM
- EXISTING UTILITY POLE/OH LINE
- EXISTING WETLAND BOUNDARY
- █ EXISTING BUILDING
- 310 --- PROPOSED CONTOUR
- PROPOSED EDGE OF GRAVEL
- █ PROPOSED STABILIZED CONSTRUCTION EXIT
- X- PROPOSED FENCE LINE
- █ PROPOSED EDGE GRAVEL YARD SURFACE
- (LP-XX) PROPOSED SITE LAYOUT POINT
- PROPOSED TREE LINE
- PROPOSED SILT FENCE
- PROPERTY LINE
- █ PROPOSED CHECK DAM
- PROPOSED BUILDING UNDERDRAIN

NOTES:

1. TOPOGRAPHIC SURVEY PERFORMED BY SACKETT & BRAKE SURVEY, INC. DATED JUNE 12, 2017 AND JUNE 18, 2018. HORIZONTAL DATUM - NAD83 MAINE STATE PLANE COORDINATE SYSTEM, WEST ZONE, US SURVEY FEET, VERTICAL DATUM-NAVD88 FEET.
2. ADDITIONAL TRANSMISSION LINE REFERENCE DRAWINGS, 1011-T200-24 AND 1011-T251-023.

LOUIS C. PERRON
ROBERTA M. PERRON
1745/003 JULY 26, 1984
LEWISTON MAP 138 LOT 35

GEORGE P. SCHOTT
3580/349 APRIL 12, 1996
GREENE MAP 2 LOT 55

GENERAL SITE PLAN

SCALE: 1"= 100'

ISSUED FOR REVIEW
NOT FOR CONSTRUCTION
07/12/18

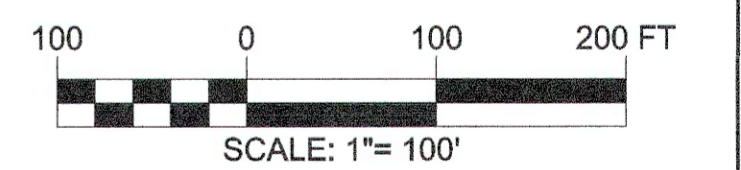

REV.	DESCRIPTION	DATE	BY	CK	APP
B	MEDEP PERMIT SET COMMENT REVISIONS	05/29/18	EVD	KRV	
C	ACCESS ROAD ALIGNMENT REVISIONS	07/12/18	RST	KRV	

OWNER ENGINEER: _____ APPROVAL STAMP: _____

DRAWING PREPARED BY: _____ ACCEPTED BY OE: _____

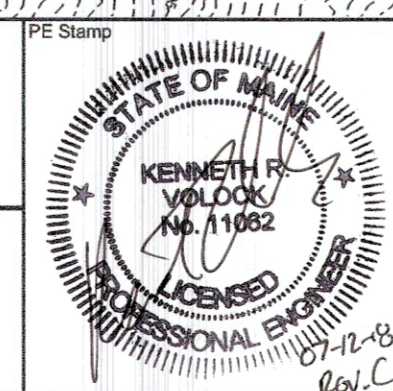

REV.	DATE	BY	DESCRIPTION	APP.	DATE:

IUSA ENGINEERING
CONFIDENTIAL, PROPRIETARY and TRADE SECRET INFORMATION
Property of Iberdrola, USA



GENERAL SITE PLAN
PROPOSED CONDITIONS
SH 2 OF 2

MERRILL ROAD/1076 LEWISTON, ME

DR: EVD SCALE: 1"=100' FILE: 1076-003-001SH002.DWG
CK: KRV NO.
APP: DATE: 1076-003-001
REV. C

ANSI D CADD Drawings DO NOT REVISE MANUALLY.



LEGEND

	EXISTING CONTOUR
	EXISTING EDGE OF PAVEMENT
	EXISTING FENCE LINE
	EXISTING ROCK OR EXPOSED LEDGE
	EXISTING SPOIL PILE
	EXISTING TREE LINE
	EXISTING TRANSMISSION RIGHT-OF-WAY
	EXISTING STREAM
	EXISTING UTILITY POLE/OH LINE
	EXISTING WETLAND BOUNDARY
	EXISTING BUILDING
	PROPOSED CONTOUR
	PROPOSED EDGE OF GRAVEL
	PROPOSED GRAVEL ACCESS RAMP
	PROPOSED FENCE LINE
	PROPOSED STABILIZED CONSTRUCTION EXIT
	PROPOSED SITE LAYOUT POINT
	PROPOSED TREE LINE
	PROPOSED SILT FENCE
	PROPERTY LINE
	PROPOSED CHECK DAM
	PROPOSED EDGE OF PAVEMENT

NOTES:

1. TOPOGRAPHIC SURVEY PERFORMED BY SACKETT & BRAKE SURVEY, INC. DATED JUNE 12, 2017. HORIZONTAL DATUM - NAD83 MAINE STATE PLANE COORDINATE SYSTEM, WEST ZONE, US SURVEY FEET, VERTICAL DATUM-NAVD88 FEET.
2. ADDITIONAL TRANSMISSION LINE REFERENCE DRAWINGS, 1011-T200-24 AND 1011-T251-023.

- WORK NOTES**
- 1 PROPOSED TREE LINE.
 - 2 SUBSTATION YARD - SEE SECTION A-A & B-B, DWG 1076-003-005 SHEET 1.
 - 3 PAVED VEHICULAR CIRCULATION ROUTES - SEE DETAIL, DWG 1076-003-005 SHEET 1.
 - 4 GRAVEL ACCESS ROAD - SEE DETAIL, DWG 1076-003-005 SHEET 1.
 - 5 VEGETATED DRAINAGE SWALE - SEE DETAIL, DWG 1076-003-005 SHEET 1.
 - 6A LEVEL SPREADER LS-2 - SEE DETAIL, DWG 1076-003-005 SHEET 2.
 - 7A GRASSED UNDERDRAIN SOIL FILTER #1 - SEE DETAIL, DWG 1076-003-002 SHEET 2.
 - 8A 24" CULVERT PIPE- INV IN = 312.0', INV OUT = 310.0'
 - 8B 24" CULVERT PIPE- INV IN = 305.60', INV OUT = 305.30'
 - 8C 36" CULVERT PIPE-INV IN = 305.30', INV OUT = 305.00'
 - 9A CATCH BASIN, CB-2 - RIM ELEV. = 316.0'. SEE DETAIL DWG 1076-003-002 SHEET 2.
 - 9B CATCH BASIN/SEDIMENT BASIN OUTLET STRUCTURE, CB-1 - SEE DETAIL DWG 1076-003-002 SHEET 2.
 - 10 ALL SLOPES GREATER THAN 3 TO 1 SHALL RECEIVE EROSION CONTROL BLANKET - SEE DETAIL DWG 1076-003-005 SHEET 4.
 - 11A SOIL FILTER OUTLET STRUCTURE #1 - SEE DETAIL, DWG. 1076-003-002 SHEET 2.
 - 12 RIP RAP PLUNGE POOL - SEE DETAIL, DWG. 1076-003-005 SHEET 2.
 - 13 EMERGENCY SPILLWAY - SEE DETAIL, DWG. 1076-003-002 SHEET 2.
 - 14 STONE FOREBAY - SEE DETAIL, DWG. 1076-003-002 SHEET 2.
 - 15 4" PERFORATED SCH. 40 PVC UNDERDRAIN - SEE DETAIL, DWG. 1076-003-002 SHEET 2.
 - 16 4" SCH. 40 PVC UNDERDRAIN - SEE DETAIL, DWG. 1076-003-002 SHEET 2.

GRADING PLAN
SCALE: 1"= 50'

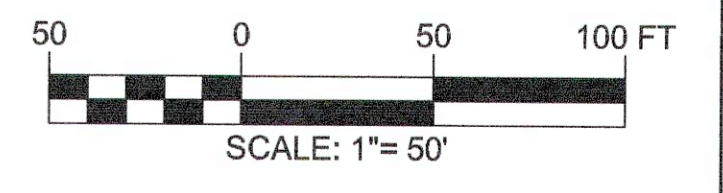

ISSUED FOR REVIEW
NOT FOR CONSTRUCTION
07/12/18

REV.	DESCRIPTION	DATE	BY	CK	APP	OWNER ENGINEER:	APPROVAL STAMP:
B	MEDEP PERMIT SET COMMENT REVISIONS	08/29/18	EVD	KRV			
C	ACCESS ROAD ALIGNMENT REVISIONS	07/12/18	RST	KRV			

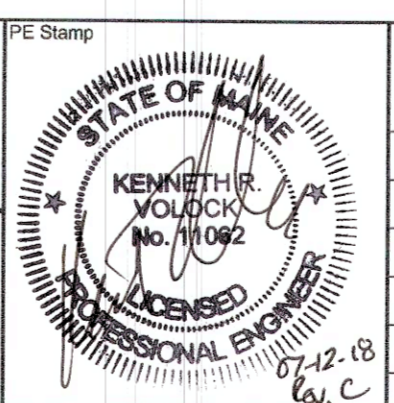

IUSA ENGINEERING
CONFIDENTIAL, PROPRIETARY and TRADE SECRET INFORMATION
Property of Iberdrola, USA

CMP
IBERDROLA - USA

DRAWING PREPARED BY: ACCEPTED BY OE:

REV.	DATE	BY	DESCRIPTION	APP.	DATE:

GRADING PLAN

SH 1 OF 5

MERRILL ROAD/1076 LEWISTON, ME

DR. EVD	SCALE: 1"=50'	FILE: 1076-003-002SH001.DWG	REV.
CK. KRV	NO.		
APP.			

1076-003-002 C

ANSI D CADD Drawing, DO NOT REVISE MANUALLY.

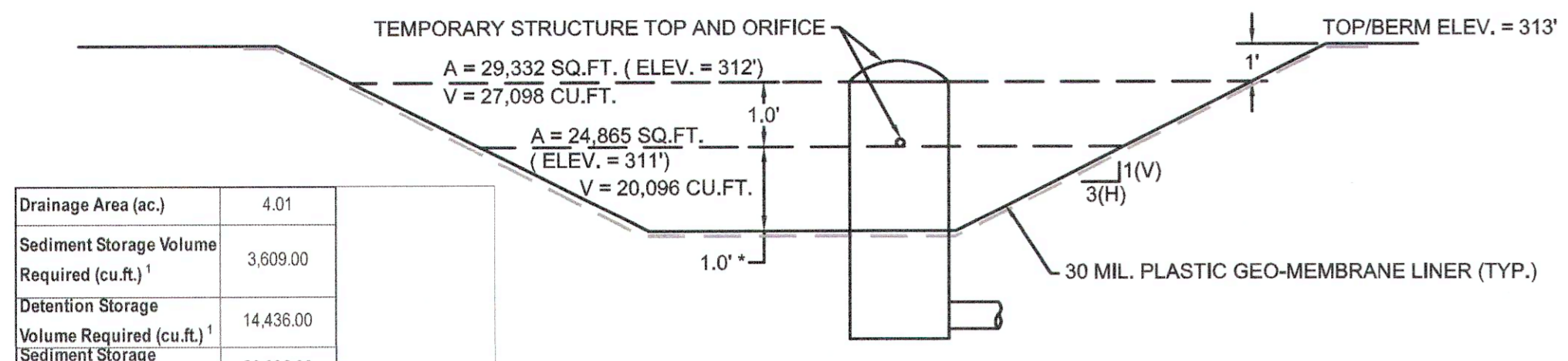

Drainage Area (ac.)	4.01
Sediment Storage Volume Required (cu.ft.) ¹	3,609.00
Detention Storage Volume Required (cu.ft.) ¹	14,436.00
Sediment Storage Provided (cu.ft.)	20,096.00
Detention Storage Provided (cu.ft.)	27,098.50
Storm Event	10-year/24-hr/Type II
V _{avg} (in.)	1.88
Q _{avg} (cfs)	7.30
Q _{avg} /DA (cfs/ac)	1.82
Q ₁₀ (cfs)	0.0250
Max. Q _{avg} (cfs)	0.18
Orifice Diameter (in.)	2.00
Outflow Achieved (cfs)	0.16

NOTES:
 CONVERT THE SEDIMENT BASIN TO A GRADED DEPRESSION WITH CATCH BASIN TOP AT GRADE BY LOWERING THE GRATE TOP FOLLOWING FINAL STABILIZATION
 GRADE SEDIMENT BASIN AND SURROUNDING AREA TO FINISHED PLAN GRADES UP TO ELEVATION 312' (MIN.) PRIOR TO UPSTREAM DISTURBANCES
 * 1' OF STORAGE ASSUMED. ACTUAL PERMANENT GRATE ELEVATION = 310.0'

ELEVATION	AREA (SQ.FT.)	INCR. VOLUME (CU.FT.)	TOTAL VOLUME (CU.FT.)
310.00	15,327.00		
311.00	24,865.00	20,096.00	20,096.00
312.00	29,332.00	27,098.50	47,194.50

1. NRCS Conservation Practice Standard Code 350 - Sediment Basin
 2. Maine Erosion and Sediment Control BMPs (10/2016) Ch. 2 - Sediment Basins, Graph C.1

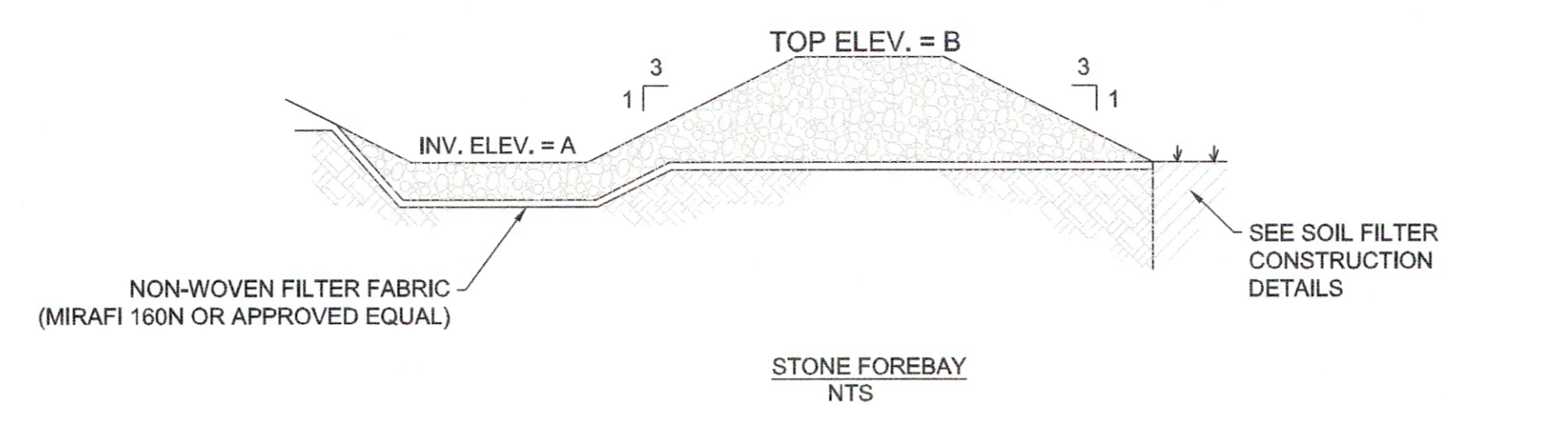

STONE FOREBAY ELEVATIONS		
SOIL FILTER NO.	A	B
SOIL FILTER #1	310.0	310.5

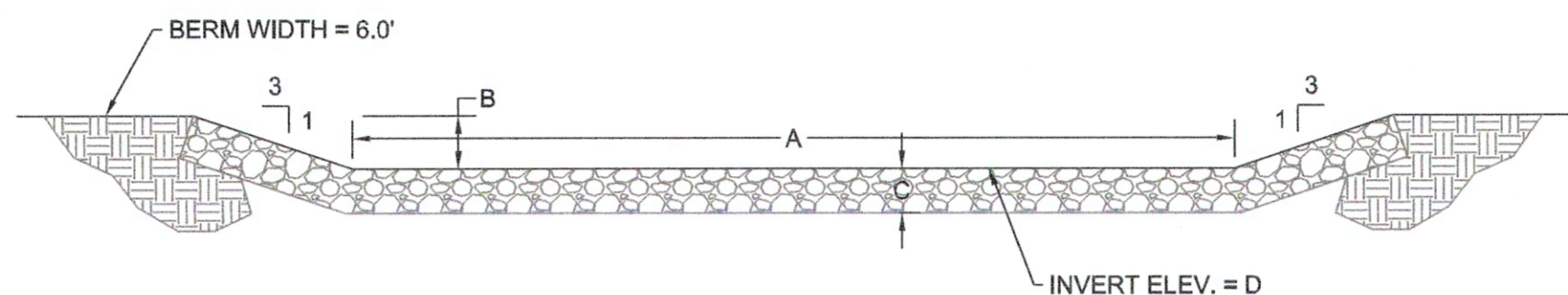

EMERGENCY SPILLWAY GEOMETRY						
UNDERDRAIN FILTER NUMBER	A	B	C	D	RIP RAP D50	25-YR WATER ELEV.
SOIL FILTER #1	55'	1.30'	18"	310.70	9"	310.83

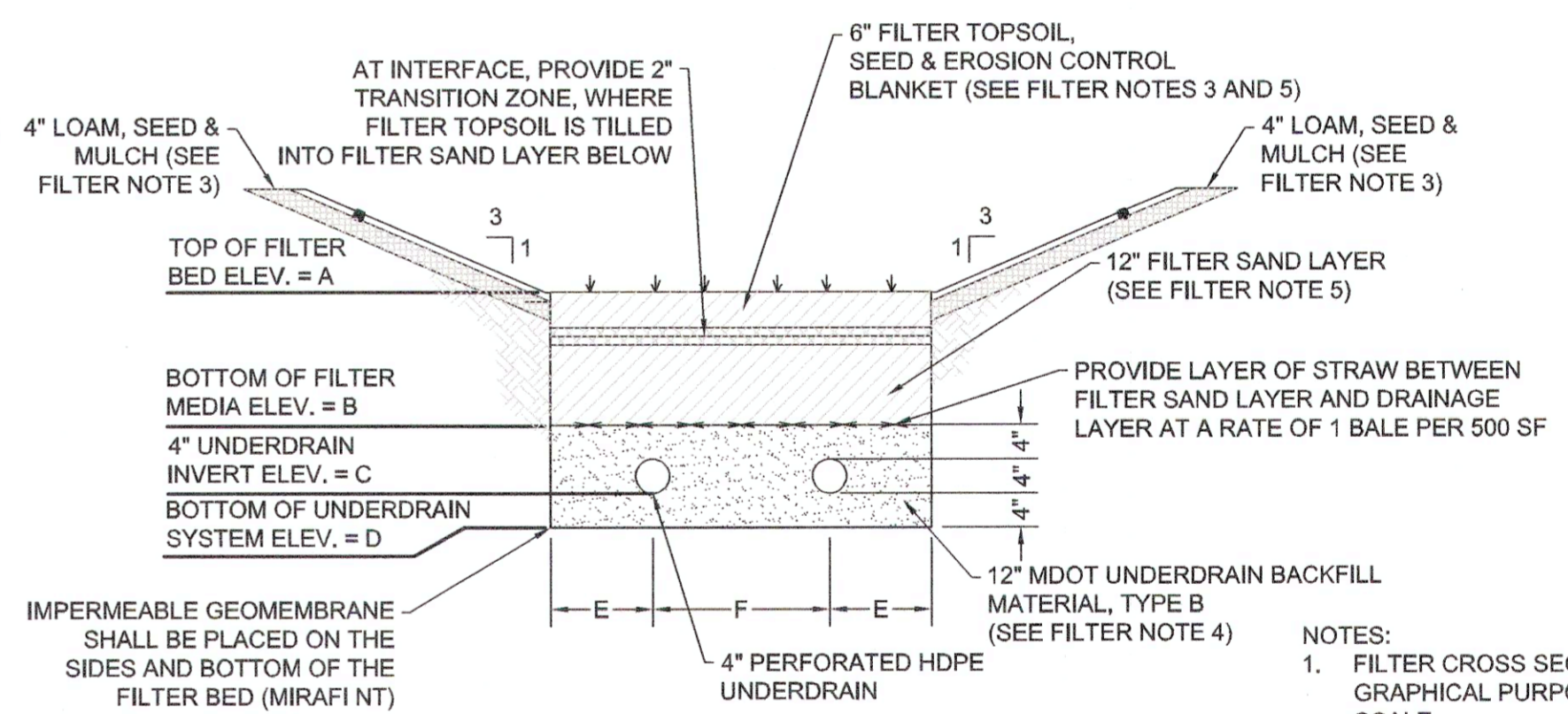
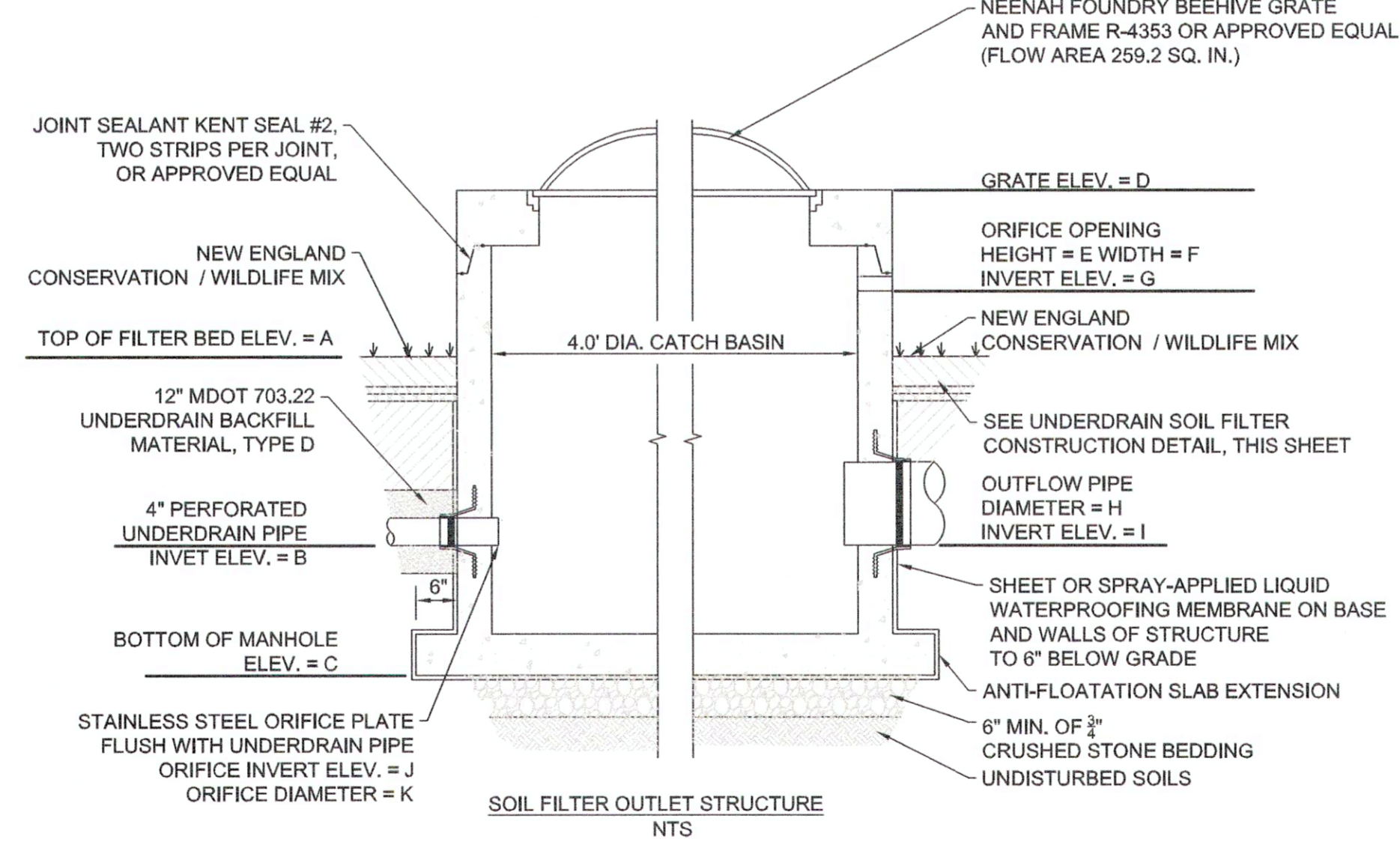
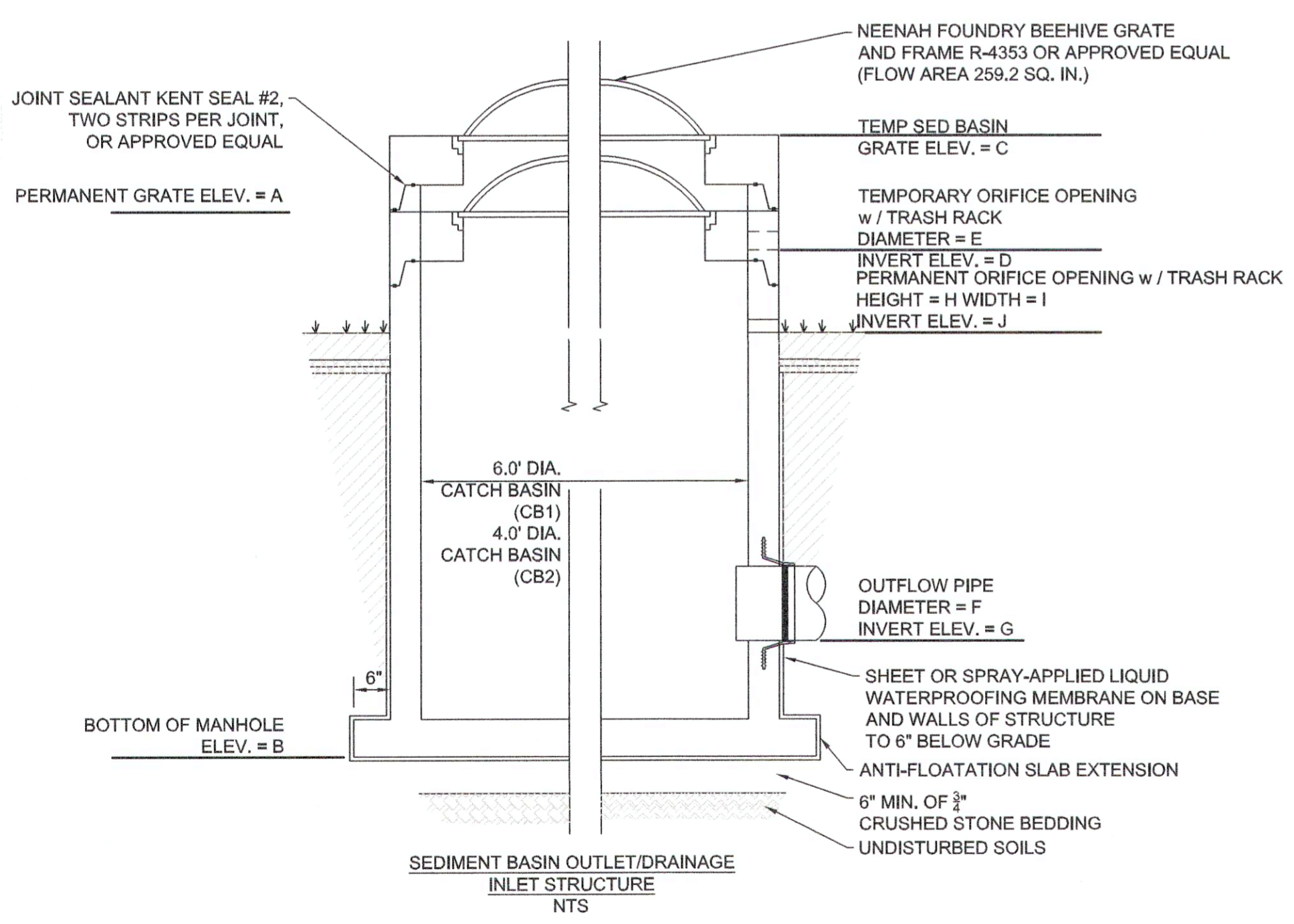
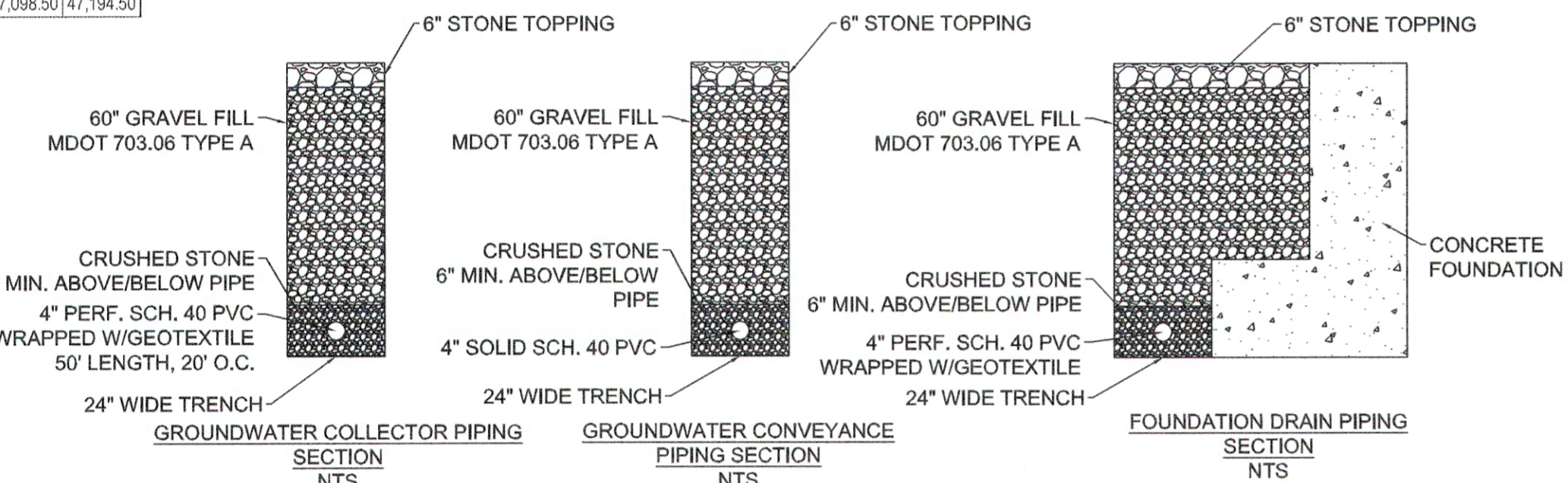

GRASSED UNDERDRAIN SOIL FILTER ELEVATIONS/GEOMETRY						
UNDERDRAIN FILTER NUMBER	A	B	C	D	E	F
SOIL FILTER #1	308.00	306.33	305.66	305.33	7.00	11.00

SOIL FILTER OUTLET STRUCTURE ELEVATIONS/GEOMETRY										
UNDERDRAIN FILTER NUMBER	A	B	C	D	E	F	G	H	I	J
SOIL FILTER #1	308.00	305.66	304.83	312.00	6"	35"	309.00	24"	305.60	305.66

SEDIMENT BASIN OUTLET / CATCH BASIN STRUCTURE ELEVATIONS/GEOMETRY										
STRUCTURE	A	B	C	D	E	F	G	H	I	J
CB 1	310.33	304.80	312.00	311.00	2"	24"	305.30	4"	36"	309.50
CB 2	316.00	311.50	N/A	N/A	N/A	24"	312.00	N/A	N/A	N/A

- FILTER NOTES:
- UNDERDRAIN PIPES SHALL BE SCH. 40 PVC. ENDS OF UNDERDRAIN PIPING SHALL BE PLUGGED WITH PIPE FITTINGS. PIPE JOINTS SHALL BE FULLY GLUED.
 - COMPACT EMBANKMENT MATERIAL TO 93% OF MAXIMUM DENSITY AS DETERMINED BY ASTM D1557.
 - FILTER BED & SIDE SLOPES SHALL BE SEEDED USING "NEW ENGLAND CONSERVATION/WILDLIFE MIX" FROM NEW ENGLAND WETLAND PLANTS, INC. OF AMHERST, MA. OR APPROVED EQUAL (APPLICATION RATE 25#/ACRE).
 - MDOT 703.22 UNDERDRAIN BACKFILL MATERIAL, TYPE B SPECIFICATIONS.

SIEVE	% BY WEIGHT
1	90-100
1/2	75-100
#4	50-100
#20	15-80
#50	0-15
#200	0-5

- FILTER MEDIA MATERIALS:
 - FILTER TOPSOIL LAYER: A 6-INCH LAYER OF LOAMY TOPSOIL SUCH AS USDA SANDY LOAM TOPSOIL WITH 5-8% HUMIFIED ORGANIC MATTER. SCREENED TOPSOIL FROM THE SITE MAY BE APPROPRIATE BUT SHALL BE TESTED FOR ORGANIC CONTENT. ORGANIC MATTER (SUCH AS SUPERHUMUS OR EQUIVALENT) MAY BE ADDED IF NECESSARY, PROVIDED THAT THE RESULTING TEXTURE IS SUITABLE. SEE EROSION CONTROL DETAILS FOR EROSION CONTROL BLANKET INSTALLATION REQUIREMENTS.
 - FILTER SAND LAYER: A 12-INCH LAYER OF LOAMY COARSE SAND PER MAINE DEP STORMWATER BEST MANAGEMENT PRACTICES TABLE 7.1.3.

SIEVE	% BY WEIGHT
#10	85-100
#20	70-100
#60	15-40
#200	8-15
#200 (CLAY SIZE)	<2.0

- FILTER CONSTRUCTION INSPECTION AND TESTING NOTES:
- INSPECTION OF THE FILTER BASIN SHALL BE PROVIDED FOR EACH PHASE OF CONSTRUCTION BY THE DESIGN ENGINEER WITH REQUIRED REPORTING TO THE MAINE DEP.
 - AT A MINIMUM INSPECTIONS WILL OCCUR:
 - AFTER PRELIMINARY CONSTRUCTION OF THE FILTER GRADES AND ONCE THE UNDERDRAIN PIPES ARE INSTALLED BUT NOT BACKFILLED;
 - AFTER THE DRAINAGE LAYER IS CONSTRUCTED AND PRIOR TO THE INSTALLATION OF THE FILTER SAND LAYER;
 - AFTER FILTER SAND LAYER IS CONSTRUCTED AND PRIOR TO THE INSTALLATION OF THE FILTER TOPSOIL LAYER;
 - AFTER THE FILTER TOPSOIL LAYER HAS BEEN INSTALLED AND SEEDED; AND
 - AFTER ONE YEAR TO INSPECT HEALTH OF THE VEGETATION AND MAKE CORRECTIONS.
 - THE CONTRACTOR SHALL PROVIDE SUBMITTALS FOR EACH COMPONENT OF THE FILTER MEDIA. IDENTIFYING THE SOURCE.
 - ALL MATERIAL USED FOR THE CONSTRUCTION OF THE FILTER BASIN WILL BE APPROVED BY THE DESIGN ENGINEER, AFTER TESTS BY A CERTIFIED LABORATORY SHOW THAT THEY ARE PASSING MAINE DEP SPECIFICATIONS.
 - THE CONTRACTOR SHALL SUBMIT SAMPLES OF EACH TYPE OF MATERIAL TO BE USED FOR THE MIXED FILTER MEDIA AND SAMPLES OF THE UNDERDRAIN BEDDING MATERIAL. SAMPLES SHALL BE A COMPOSITE OF THREE DIFFERENT LOCATIONS (GRABS) FROM THE STOCKPILE OR PIT FACE. SAMPLE SIZE REQUIRED WILL BE DETERMINED BY THE TESTING LABORATORY.
 - THE CONTRACTOR SHALL PERFORM, OR HAVE PERFORMED, A SIEVE ANALYSIS CONFORMING TO ASTM C138 ON EACH TYPE OF THE SAMPLE MATERIAL. ALL MATERIALS SHALL HAVE A CLAY CONTENT OF LESS THAN 2% AS DETERMINED BY HYDROMETER GRAIN SIZE ANALYSIS.
 - THE CONTRACTOR SHALL PERFORM, OR HAVE PERFORMED, A PERMEABILITY TEST ON THE SOIL FILTER MEDIA MATERIALS CONFORMING TO ASTM D2434 WITH THE MIXTURE COMPACTED TO 90 - 92% OF MAXIMUM DRY DENSITY BASED ON ASTM D698.

**ISSUED FOR PERMITTING
 NOT FOR CONSTRUCTION
 08/09/18**

REV.	DESCRIPTION	DATE	BY	CK	APP	OWNER ENGINEER:
B	MEDEP PERMIT SET COMMENT REVISIONS	05/29/18	TJG	KRV		
C	ACCESS ROAD ALIGNMENT REVISIONS	07/12/18	TJG	KRV		
D	STORMWATER MANAGEMENT REVISIONS	08/09/18	TJG	KRV		

APPROVAL STAMP: [Signature]
 PE Stamp: [Signature]
 DRAWING PREPARED BY: [Signature]
 ACCEPTED BY OE: [Signature]

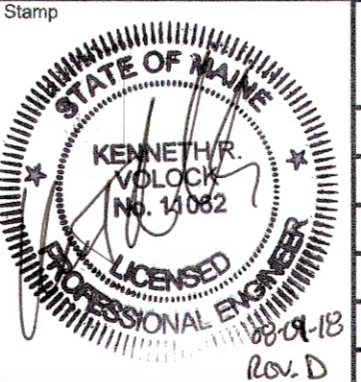

REV.	DATE	BY	DESCRIPTION	APP.	DATE

STORMWATER TREATMENT PLAN
 SH 2 OF 5
 MERRILL ROAD/1076 LEWISTON, ME
 SCALE: N/A FILE: 1076-003-002S#002.DWG
 1076-003-002 REV. D

ANSI D CADD Drawing. DO NOT REVISION MANUALLY.

ANSI D CADD Drawing, DO NOT REVISE MANUALLY.

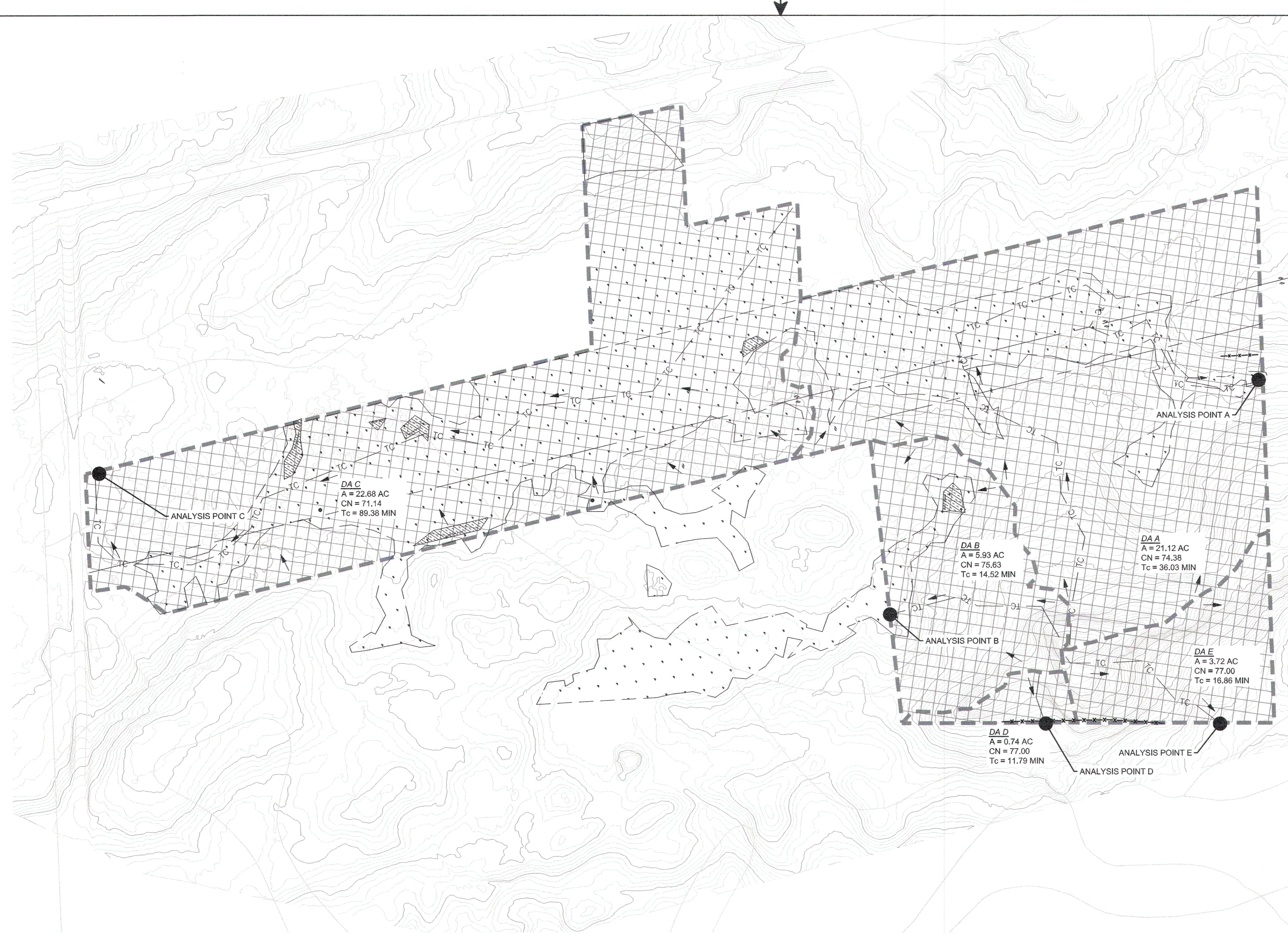

LEGEND

- 750 --- EX. MAJOR CONTOUR
- 744 --- EX. MINOR CONTOUR
- TC --- EX. TIME OF CONCENTRATION
- HrD (D Soils)
HrC (C Soils) --- EX. SOIL BOUNDARY
- EX. OVERHEAD UTILITY
- EX. FLOW DIRECTION ARROW
- EX. DRAINAGE BOUNDARY
- EX. PROPERTY BOUNDARY
- EX. WETLAND
- EX. VERNAL POOL
- ANALYSIS POINT
- EX. WOODS

EXISTING CONDITIONS HYDRAULIC SUMMARY			
DRAINAGE AREA	2 - YEAR FLOW RATE (CFS)	10 - YEAR FLOW RATE (CFS)	25 - YEAR FLOW RATE (CFS)
A	11.75	26.46	36.58
B	5.09	11.09	15.17
C	5.88	14.62	20.83
D	0.74	1.55	2.09
E	3.31	7.00	9.47

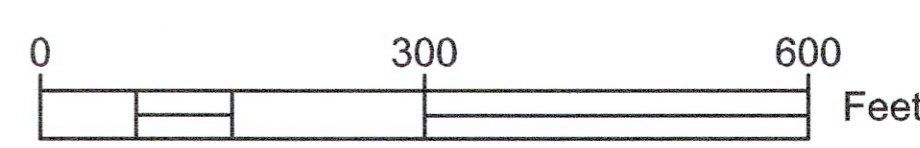
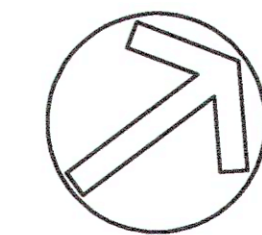

**ISSUED FOR PERMITTING
NOT FOR CONSTRUCTION
08/09/18**

REV.	DESCRIPTION	DATE	BY	CK	APP	OWNER ENGINEER:	APPROVAL STAMP:
B	ACCESS ROAD ALIGNMENT REVISIONS	07/12/18	TJG	KRV			
C	STORMWATER MANAGEMENT REVISIONS	08/09/18	TJG	KRV			
						DRAWING PREPARED BY:	ACCEPTED BY OE:

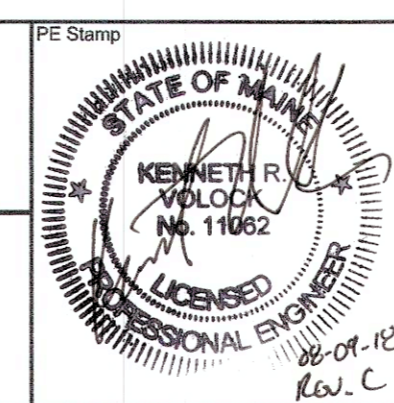

IUSA ENGINEERING
CONFIDENTIAL, PROPRIETARY and TRADE SECRET INFORMATION
Property of Iberdrola, USA

CMP
IBERDROLA - USA

PRE-DEVELOPMENT STORMWATER PLAN

SH 3 OF 5

MERRILL ROAD/1076 LEWISTON, ME

DR: TJG	SCALE: 1" = 150'	FILE: 1076-003-002SH003.DWG
CK: KRV	NO.	
APP:		
DATE:		

1076-003-002 C

REV.	DATE	BY	DESCRIPTION	APP.

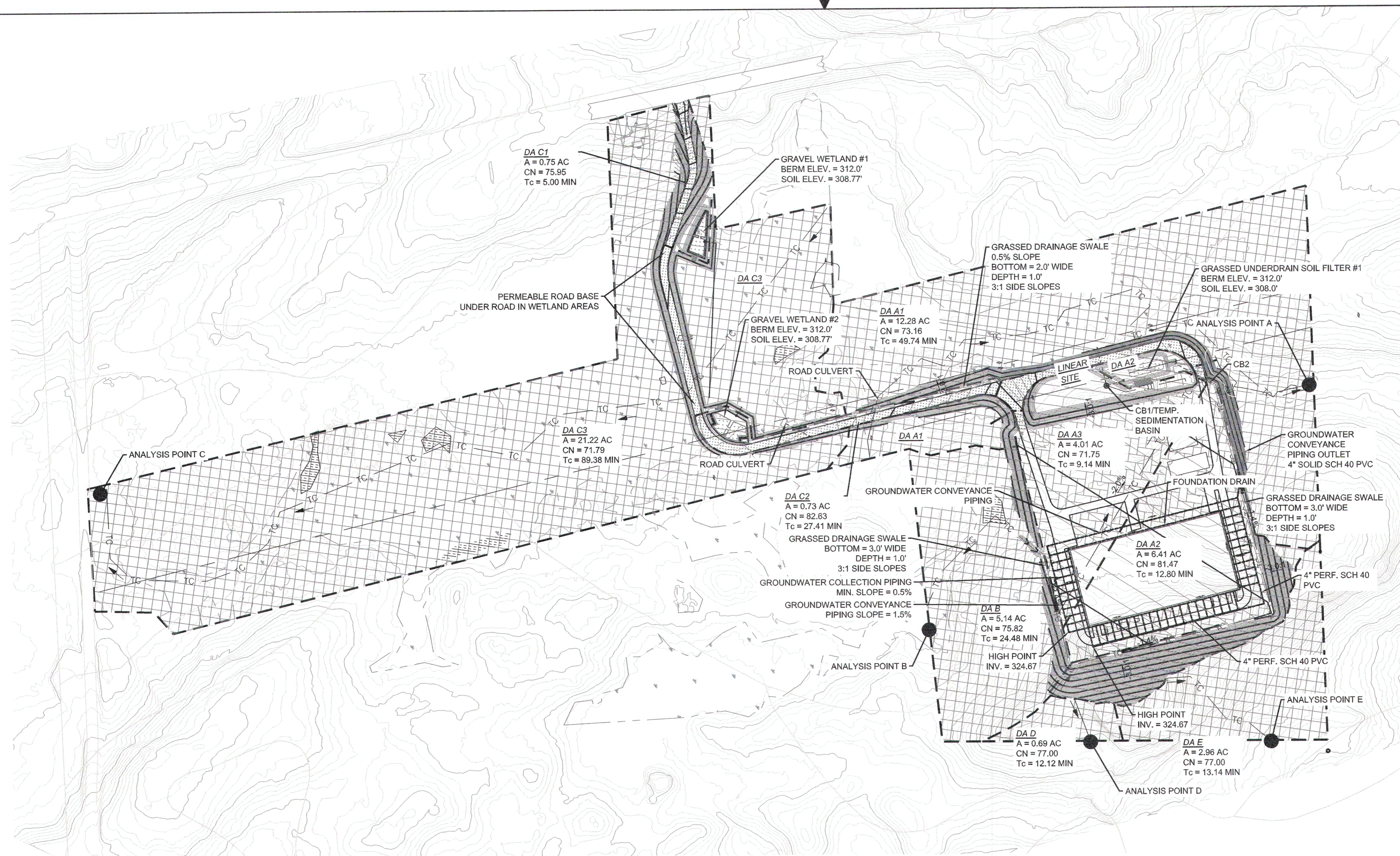

LEGEND	
750	EX. MAJOR CONTOUR
744	EX. MINOR CONTOUR
Hd (D Soils)	EX. SOIL BOUNDARY
Hc (C Soils)	EX. OVERHEAD UTILITY
	EX. PROPERTY BOUNDARY
	EX. WETLAND
	EX. VERNAL POOL
750	PROP. MAJOR CONTOUR
744	PROP. MINOR CONTOUR
TC	PROP. TIME OF CONCENTRATION
→	PROP. FLOW DIRECTION ARROW
---	PROP. DRAINAGE BOUNDARY
●	ANALYSIS POINT
---	PROP. CULVERT/PIPING
---	PROP. SITE/LINEAR DEMARCATION
	PROP. IMPERVIOUS PAVING/ROOF
	PROP. STONE PAD
	PROP. DEVELOPED GRASS
	PROP. UNDERDRAIN SOIL FILTER/GRAVEL WETLAND

PROPOSED CONDITIONS HYDRAULIC SUMMARY						
DRAINAGE AREA	2 - YEAR FLOW RATE (CFS)	10 - YEAR FLOW RATE (CFS)	25 - YEAR FLOW RATE (CFS)	PEAK 2 - YEAR FLOW RATE AT ANALYSIS POINT (IF SUBSHEDS PRESENT)	PEAK 10 - YEAR FLOW RATE AT ANALYSIS POINT (IF SUBSHEDS PRESENT)	PEAK 25 - YEAR FLOW RATE AT ANALYSIS POINT (IF SUBSHEDS PRESENT)
A1	5.33	12.43	17.35			
A2	7.96	15.32	20.01	11.73	23.66	31.35
A3	2.99	7.15	10.03			
B	3.66	8.01	10.95	N/A	N/A	N/A
C1	0.81	1.70	2.30			
C2	0.74	1.40	1.82	5.81	14.08	19.96
C3	5.79	14.12	19.95			
D	0.68	1.43	1.93	N/A	N/A	N/A
E	2.85	6.01	8.13	N/A	N/A	N/A

STORMWATER TREATMENT REQUIREMENTS (% OF TREATED AREA)				
LAND TYPE	STATION	STATION % TREATED	LINEAR	LINEAR % TREATED
IMPERVIOUS TOTAL ¹	7.15 AC	99.33%	0.96 AC	78.70%
IMPERVIOUS TREATED	7.10 AC		0.76 AC	
DEVELOPED TOTAL ^{2,3}	10.71 AC	83.75%	2.71 AC	54.90%
DEVELOPED TREATED	8.97 AC		1.49 AC	

¹IMPERVIOUS TOTAL DOES NOT INCLUDE 0.20 ACRES OF EXEMPTED WETLAND ROAD CROSSING AREA WITH PERMEABLE ROAD BASE

²DEVELOPED TOTAL DOES NOT INCLUDE 0.47 ACRES OF EXEMPTED WETLAND ROAD CROSSING AREA WITH PERMEABLE ROAD BASE

³DEVELOPED AREA INCLUDES BOTH IMPERVIOUS AND LANDSCAPED SURFACES

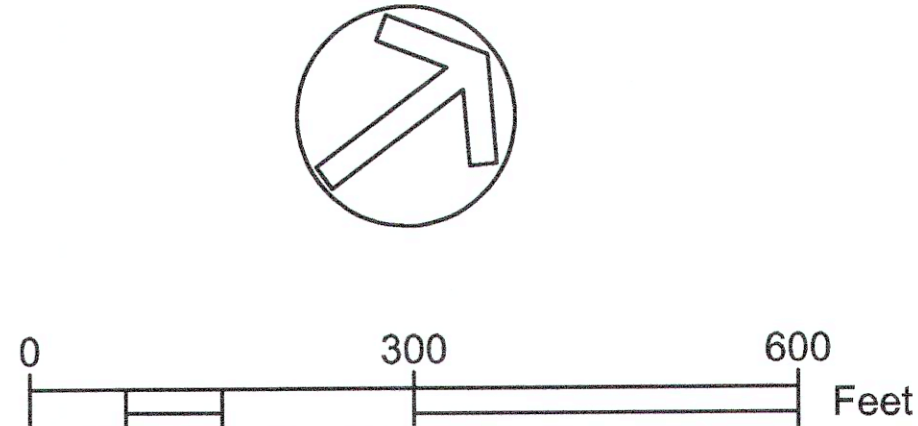

**ISSUED FOR PERMITTING
NOT FOR CONSTRUCTION
08/09/18**

REV.	DESCRIPTION	DATE	BY	CK	APP.
B	MEDEP PERMIT SET COMMENT REVISIONS	05/29/18	TJG	KRV	
C	ACCESS ROAD ALIGNMENT REVISIONS	07/12/18	TJG	KRV	
D	STORMWATER MANAGEMENT REVISIONS	08/09/18	TJG	KRV	

OWNER ENGINEER: _____ APPROVAL STAMP: _____

PE Stamp: _____

DRAWING PREPARED BY: _____ ACCEPTED BY OE: _____

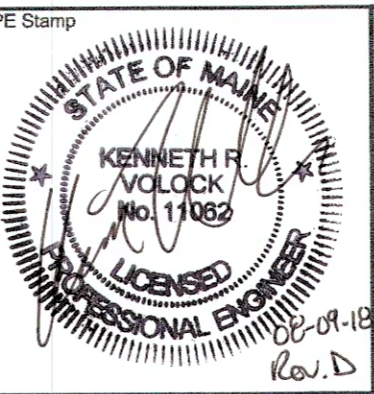

IUSA ENGINEERING
CONFIDENTIAL, PROPRIETARY and TRADE SECRET INFORMATION
Property of Iberdrola, USA

CMP
IBERDROLA - USA

REV. DATE BY DESCRIPTION APP. DATE

POST-DEVELOPMENT STORMWATER PLAN

SH 4 OF 5

MERRILL ROAD/1076 LEWISTON, ME

NO. 1076-003-002 FILE: 1076-003-002SH004.DWG

REV. 1076-003-002 D

ANSI D CAD Drawing, DO NOT REVISE MANUALLY.

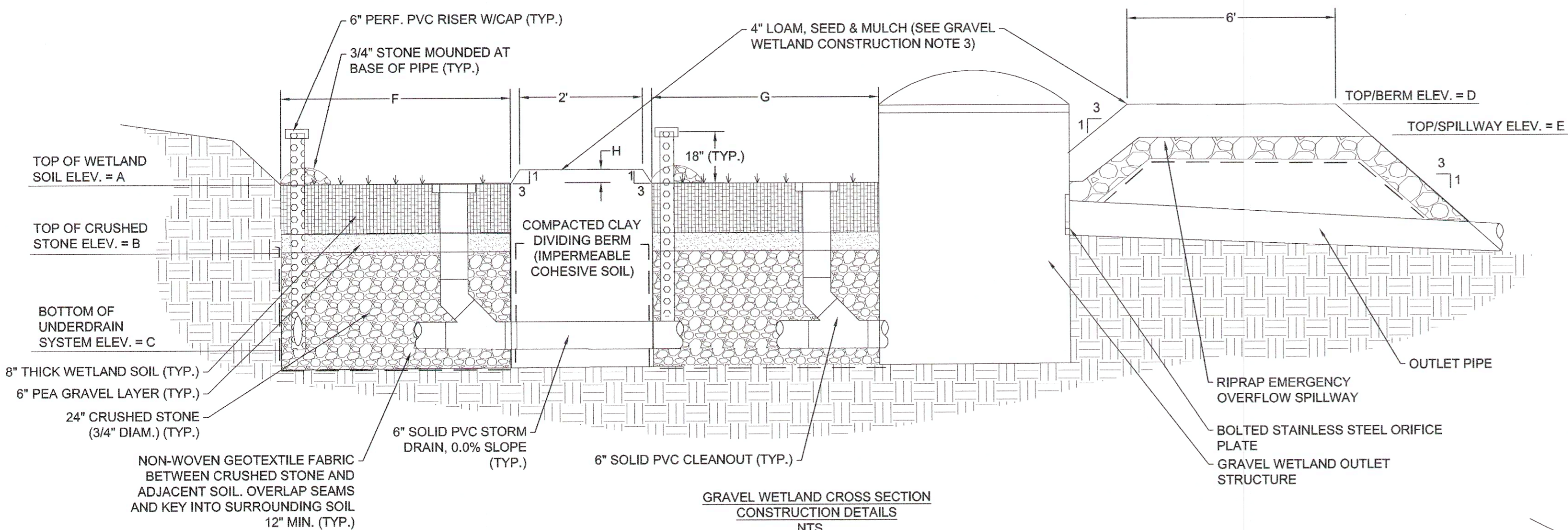

GRAVEL WETLAND CROSS SECTION CONSTRUCTION DETAILS NTS

GRAVEL WETLAND ELEVATIONS/GEOMETRY								
GRAVEL WETLAND NUMBER	A	B	C	D	E	F	G	H
GRAVEL WETLAND #1	308.77	307.60	305.60	312.00	310.70	60.00	40.00	7"
GRAVEL WETLAND #2	308.77	307.60	305.60	312.00	310.80	50.00	45.00	7"

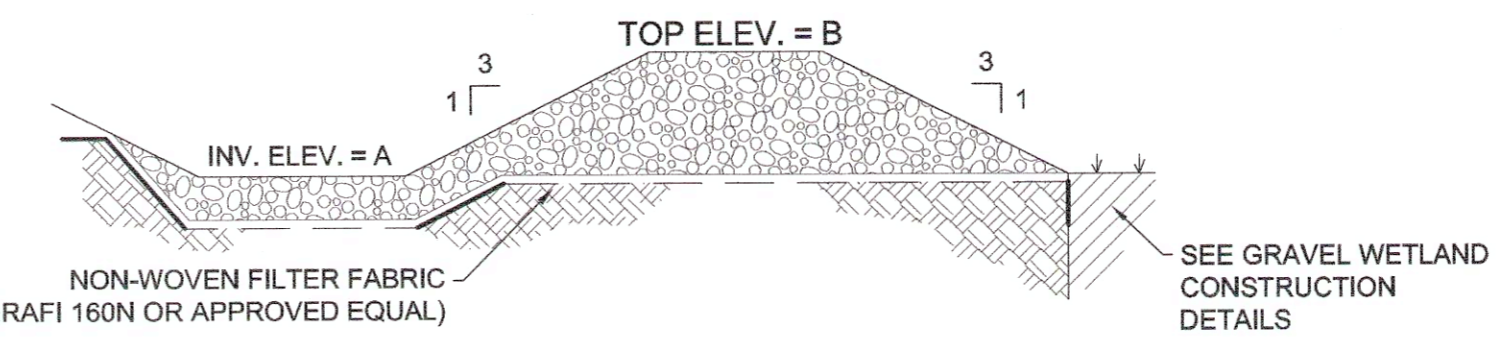

STONE FOREBAY NTS

STONE FOREBAY ELEVATIONS		
GRAVEL FILTER NO.	A	B
GRAVEL WETLAND #1	311.0	312.0
GRAVEL WETLAND #2	309.0	310.0

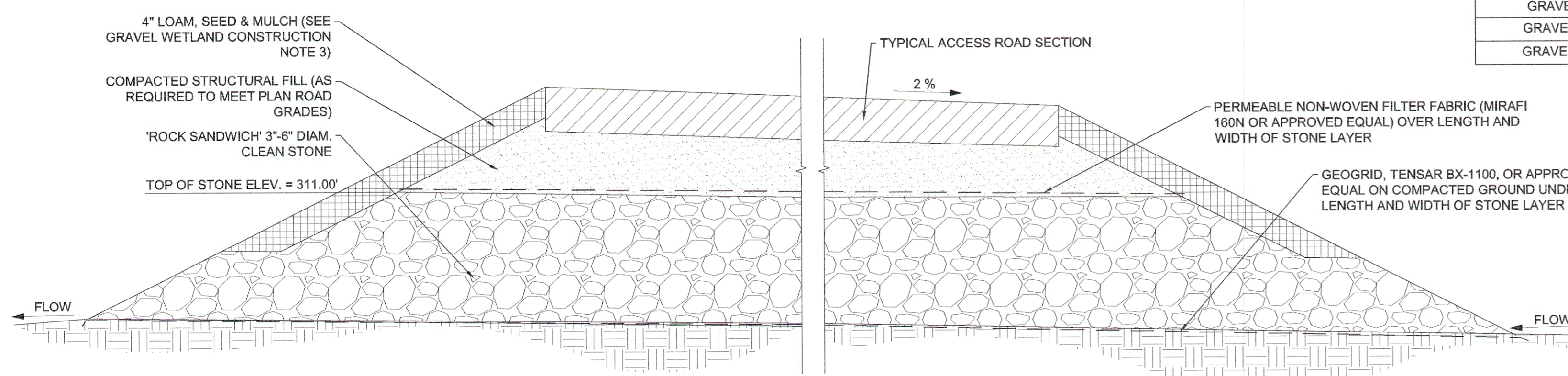

PERMEABLE ROAD BASE (ROCK SANDWICH) CROSS-SECTION NTS

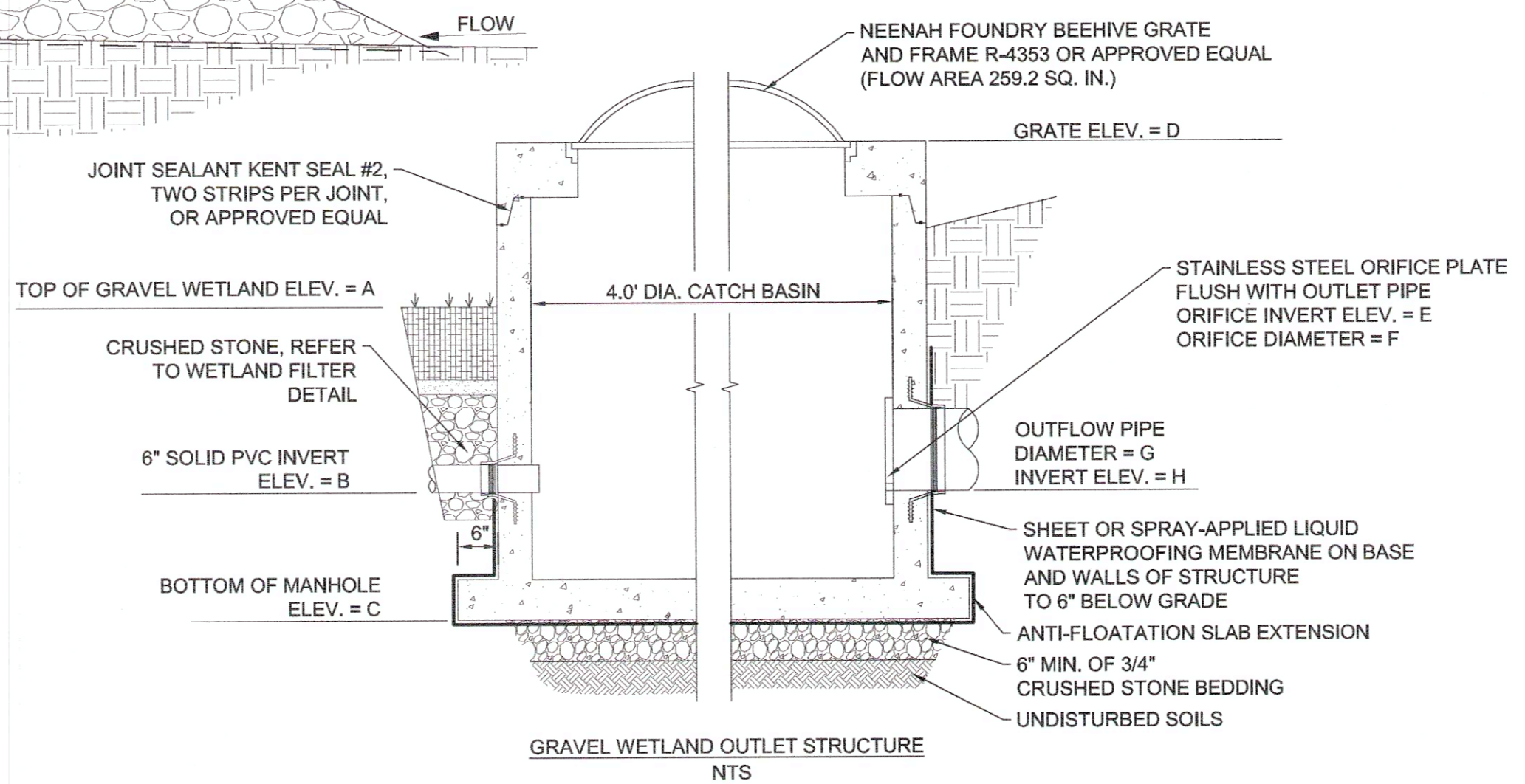

GRAVEL WETLAND OUTLET STRUCTURE NTS

EMERGENCY SPILLWAY GEOMETRY						
GRAVEL WETLAND NO.	A	B	C	D	RIP RAP D50	25-YR WATER ELEV.
GRAVEL WETLAND #1	10'	1.30'	18"	310.70	9"	310.72
GRAVEL WETLAND #2	10'	1.20'	12"	310.80	6"	310.80

GRAVEL WETLAND OUTLET STRUCTURE ELEVATIONS/GEOMETRY								
GRAVEL WETLAND NUMBER	A	B	C	D	E	F	G	H
GRAVEL WETLAND #1	308.77	305.60	304.60	312.00	308.10	7/8"	12.00	308.10
GRAVEL WETLAND #2	308.77	305.60	304.60	312.00	308.10	7/8"	12.00	308.10

GRAVEL WETLAND MATERIAL NOTES:

- SOLID DRAIN PIPES SHALL BE 6" DIAMETER SCH. 40 PVC. ENDS OF UNDERDRAIN PIPING SHALL BE PLUGGED WITH PIPE FITTINGS. PIPE JOINTS SHALL BE FULLY GLUED.
- PERFORATED UNDERDRAIN AND VERTICAL RISERS SHALL BE 6" DIAMETER PERFORATED SCH. 40 PVC. RISERS SHALL EXTEND TO 18".
- COMPACT EMBANKMENT MATERIAL TO 93% OF MAXIMUM DENSITY AS DETERMINED BY ASTM D1557.
- SIDE SLOPES SHALL BE SEEDED USING "NEW ENGLAND CONSERVATION/WILDLIFE MIX" FROM NEW ENGLAND WETLAND PLANTS, INC. OF AMHERST, MA. OR APPROVED EQUAL (APPLICATION RATE 25# / ACRE).
- WETLAND PLANTS:
 - FERTILIZER SHALL NOT BE USED TO ESTABLISH VEGETATION.
 - WETLAND PLANTS SHALL BE A MIX OF REEDS (JUNCUS EFFUSUS), CATTAILS (TYPHA LATIFOLIA) AND BULRUSH (SCIRPUS)
- RIPRAP SHALL HAVE D50 = 9" AND SHALL HAVE NON-WOVEN GEOTEXTILE BETWEEN THE RIPRAP AND SOIL LAYER.
- WETLAND MEDIA MATERIALS:
 - WETLAND SOIL SHALL BE 6" THICK MANUFACTURED MIX OF COMPOST, SAND AND FINE SOILS WITH 15% MINIMUM ORGANIC MATTER, 15% SILT PASSING #200 SIEVE AND CLAY LESS THAN 2%. HYDRAULIC CONDUCTIVITY SHALL BE BETWEEN 0.1 AND 0.01 FT./DAY
 - PEA GRAVEL LAYER SHALL BE 6" THICK LAYER OF PEA GRAVEL.
 - CRUSHED STONE LAYER SHALL BE 24" THICK LAYER OF ANGULAR 3/4" CRUSHED STONE. PIPE UNDERDRAINS SHALL HAVE A MINIMUM OF 2' OF GRAVEL COVER AND 6" OF BEDDING BELOW THE PIPE.

GRAVEL WETLAND CONSTRUCTION INSPECTION AND TESTING NOTES:

- GRAVEL WETLAND CONSTRUCTION SHALL BE STARTED NO LATER THAN SEPTEMBER 1 OR EARLIER THAN JUNE 1 WITH SEEDING AND STABILIZATION OCCURRING BY SEPTEMBER 15TH
- THE SUBAREA DRAINING TO THE WETLAND AND THE WETLAND VEGETATION MUST BE COMPLETELY ESTABLISHED AND STABILIZED BEFORE RUNOFF IS DIRECTED TO THE BASIN
- CONSTRUCT THE GRAVEL WETLAND UNDER THE SUPERVISION OF THE DESIGN ENGINEER
- MINIMUM INSPECTION REQUIREMENTS ARE AS FOLLOWS:
 - INSPECTIONS BY THE DESIGN ENGINEER DURING CONSTRUCTION:
 - AFTER PRELIMINARY CONSTRUCTION OF THE WETLAND GRADES AND ONCE THE UNDERDRAIN PIPES ARE INSTALLED BUT NOT BACKFILLED;
 - AFTER THE CRUSHED STONE LAYER IS CONSTRUCTED AND PRIOR TO THE INSTALLATION OF THE PEA GRAVEL AND WETLAND SOIL LAYERS;
 - AFTER THE WETLAND SOIL LAYER HAS BEEN INSTALLED AND PLANTED; AND
 - AFTER EVERY MAJOR STORM EVENT IN THE FIRST YEAR FOLLOWING CONSTRUCTION AND EVERY SIX MONTHS FOLLOWING THE FIRST YEAR ONE TO INSPECT HEALTH OF THE VEGETATION AND MAKE CORRECTIONS
 - POST CONSTRUCTION INSPECTIONS SHALL INCLUDE:
 - CHECK FOR ESTABLISHMENT OF VEGETATION
 - CHECK AND CLEAN RISERS IF STANDING WATER, DISCOLORED WATER OR ACCUMULATED SEDIMENTS ARE VISIBLE
 - VERIFY THAT CELLS DRAIN WITHIN 24-48 HOURS
 - CHECK FOR ACCUMULATED SEDIMENT. REMOVE SEDIMENT BEFORE ACCUMULATION DEPTH REACHES 4" OF SEDIMENT
 - CHECK AND CLEAN ALL OUTLETS, INLETS AND SPILLWAYS
 - INSPECT FOR AREAS OF EROSION AND MAKE REPAIRS
 - REPLACE DEAD OR DECAYING WETLAND VEGETATION
 - REMOVE FOREIGN PLANT SPECIES
 - POST CONSTRUCTION INSPECTIONS DURING THE FIRST YEAR SHALL INCLUDE:
 - INSPECT THAT THE SYSTEM DRAINS WITHIN 24-48 HOURS
 - PLANT WATERING AND RE-VEGETATION REQUIREMENTS
 - INSPECT FOR AREAS OF EROSION AND MAKE REPAIRS
 - CHECK INLETS, OUTLETS AND RISERS AND REMOVE ACCUMULATED SEDIMENT AND DEBRIS
- ALL MATERIAL USED FOR THE CONSTRUCTION OF THE GRAVEL WETLAND WILL BE APPROVED BY THE DESIGN ENGINEER, AFTER TESTS BY A CERTIFIED LABORATORY SHOW THAT THEY ARE PASSING MAINE DEP SPECIFICATIONS.
- THE CONTRACTOR SHALL SUBMIT SAMPLES OF EACH TYPE OF MATERIAL TO BE USED FOR THE WETLAND SOIL MEDIA AND SAMPLES OF THE UNDERDRAIN BEDDING MATERIAL. SAMPLES MUST BE A COMPOSITE OF THREE DIFFERENT LOCATIONS (GRABS) FROM THE STOCKPILE OR PIT FACE. SAMPLE SIZE REQUIRED WILL BE DETERMINED BY THE TESTING LABORATORY.
- THE CONTRACTOR SHALL PERFORM, OR HAVE PERFORMED, A SIEVE ANALYSIS CONFORMING TO ASTM C138 ON EACH TYPE OF THE SAMPLE MATERIAL. ALL MATERIALS SHALL HAVE A CLAY CONTENT OF LESS THAN 2% AS DETERMINED BY HYDROMETER GRAIN SIZE ANALYSIS.
- THE CONTRACTOR SHALL PERFORM, OR HAVE PERFORMED, A PERMEABILITY TEST ON THE SOIL FILTER MEDIA MATERIALS CONFORMING TO ASTM D2434 WITH THE MIXTURE COMPACTED TO 90 - 92% OF MAXIMUM DRY DENSITY BASED ON ASTM D698.
- THE CONTRACTOR SHALL PROVIDE SUBMITTALS FOR EACH COMPONENT OF THE GRAVEL WETLAND, IDENTIFYING THE SOURCE.

PERMEABLE ROAD BASE NOTES:

- PRIOR TO PLACING THE GEOGRID BENEATH THE STONE LAYER, PERFORM A MINIMAL AMOUNT OF STRIPPING OF EXISTING VEGETATION, ONLY AS NEEDED, TO ALLOW FOR A REASONABLY FLAT GROUND SURFACE FOR THE GEOGRID PLACEMENT
- DO NOT STUMP OR SIGNIFICANTLY GRUB WETLAND SURFACES. CUT TREES CLOSE TO THE GROUND LEAVING STUMPS IN PLACE.
- MINIMIZE GROUND DISTURBANCE AND AVOID EXCAVATING DITCHES.
- AFTER THE SITE HAS BEEN PREPARED PLACE THE GEOGRID OVER THE LENGTH OF THE ROADWAY WITH MINIMUM 18" OVERLAP AT THE JOINTS.
- THE ROCK CORE SHALL BE, AT MINIMUM, A 12" THICK LAYER OF CLEAN 3"-6" DIAMETER STONE ON GEOGRID FOR THE ENTIRE ROADWAY LENGTH AND WIDTH.
- PLACE THE PERMEABLE, NON-WOVEN FILTER FABRIC ON TOP OF THE ENTIRE LENGTH AND WIDTH OF THE ROCK LAYER. DO NOT COVER UP-GRADE AND DOWN-GRADE SIDES OF THE ROCK LAYER WITH FABRIC.
- IF INADVERTENT SOIL DISTURBANCE HAS OCCURRED UP-GRADE OF THE ROCK SANDWICH, PLACE STONE ON THE DISTURBED SOIL THAT WILL PREVENT SOIL MIGRATION TO THE ENDS OF THE ROCK SANDWICH.
- PLACE ADDITIONAL ROAD FILL TO ACHIEVE DESIGN GRADES.

**ISSUED FOR PERMITTING
NOT FOR CONSTRUCTION
08/09/18**

REV.	DESCRIPTION	DATE	BY	CK	APP	OWNER ENGINEER:	APPROVAL STAMP:	PE Stamp
A	ACCESS ROAD ALIGNMENT REVISIONS	07/12/18	TJG	KRV				
B	STORMWATER MANAGEMENT REVISIONS	08/09/18	TJG	KRV				

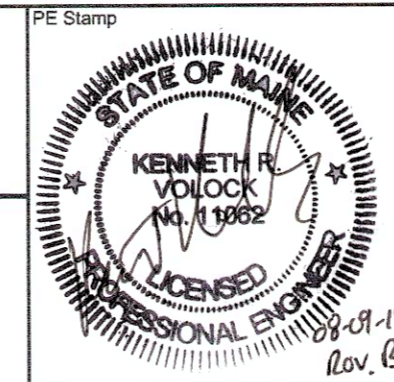

IUSA ENGINEERING
CONFIDENTIAL, PROPRIETARY AND TRADE SECRET INFORMATION
Property of Iberdrola, USA



STORMWATER TREATMENT PLAN
SH 5 OF 5
MERRILL ROAD/1076 LEWISTON, ME
DR: TJG SCALE: N/A FILE: 1076-003-002SH002.DWG
CK: KRV NO. REV. B
APP. DATE: 1076-003-002

ANSI D CADD Drawings, DO NOT REVISE MANUALLY.

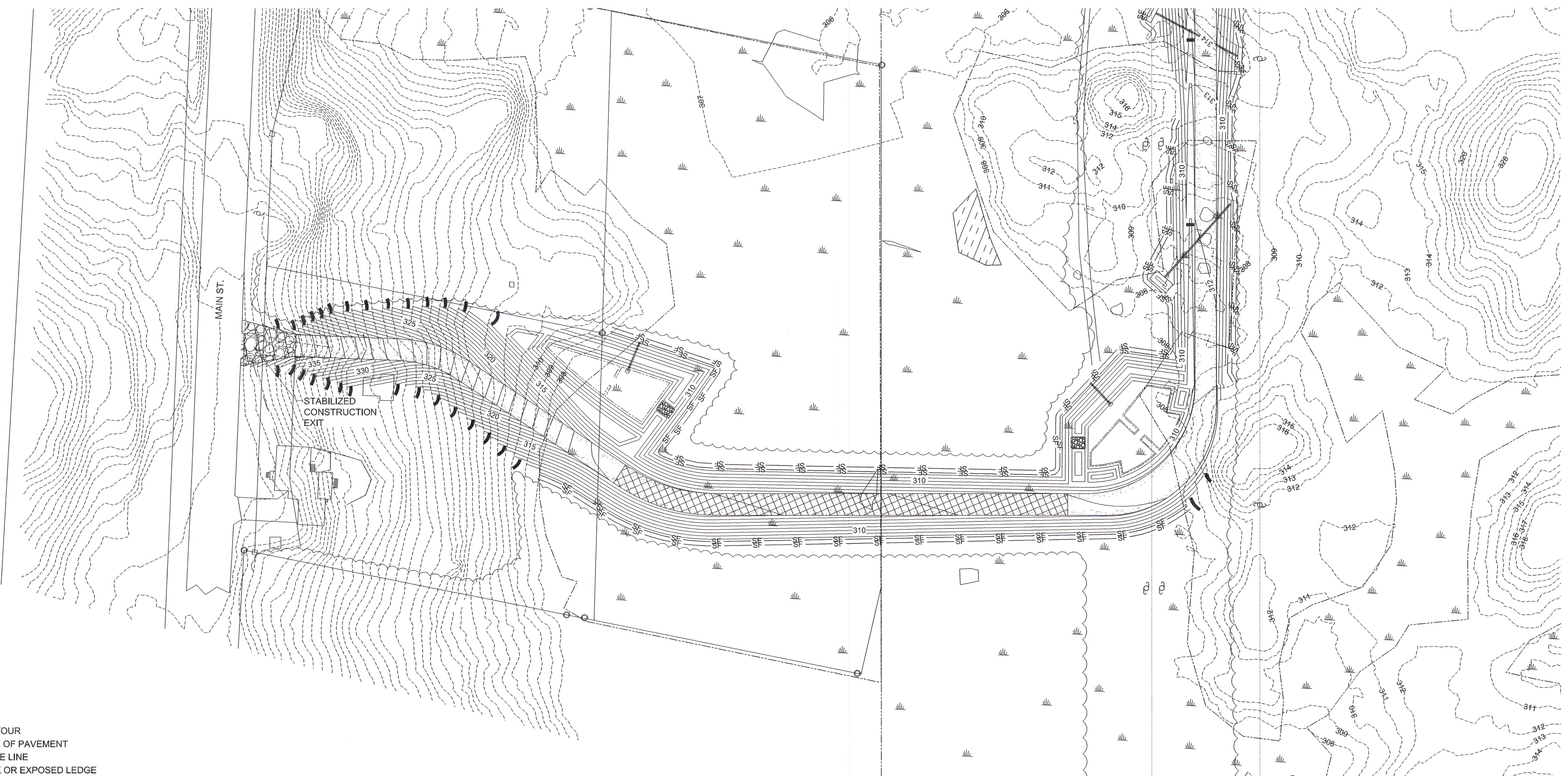

LEGEND

	EXISTING CONTOUR
	EXISTING EDGE OF PAVEMENT
	EXISTING FENCE LINE
	EXISTING ROCK OR EXPOSED LEDGE
	EXISTING TREE LINE
	EXISTING TRANSMISSION RIGHT-OF-WAY
	EXISTING STREAM
	EXISTING UTILITY POLE/OH LINE
	EXISTING WETLAND BOUNDARY
	EXISTING BUILDING
	PROPOSED CONTOUR
	PROPOSED EDGE OF GRAVEL
	PROPOSED STABILIZED CONSTRUCTION EXIT
	PROPOSED FENCE LINE
	PROPOSED EDGE GRAVEL YARD SURFACE
	PROPOSED SITE LAYOUT POINT
	PROPOSED TREE LINE
	PROPOSED SILT FENCE
	PROPERTY LINE
	PROPOSED CHECK DAM

EROSION AND SEDIMENT CONTROL PLAN 1
SCALE: 1"= 50'

**ISSUED FOR REVIEW
NOT FOR CONSTRUCTION
07/12/18**

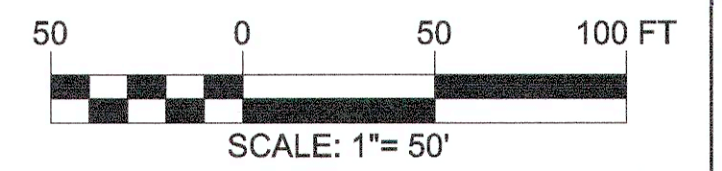

REV.	DESCRIPTION	DATE	BY	CK	APP	OWNER ENGINEER:	APPROVAL STAMP:	FE Stamp	IUSA ENGINEERING CONFIDENTIAL, PROPRIETARY and TRADE SECRET INFORMATION Property of Iberdrola, USA	CMP IBERDROLA - USA	EROSION AND SEDIMENT CONTROL PLAN 1 SH 1 OF 2	MERRILL ROAD/1076 LEWISTON, ME	
B	ACCESS ROAD ALIGNMENT REVISIONS	07/12/18	RST	KRV							DR: EVD CK: KRV APP: [] DATE: []	SCALE: 1"= 50'-0" NO. [] FILE: 1076-003-003SH001.DWG	1076-003-003 REV. B

ANSI D CADD Drawing, DO NOT REVISE MANUALLY.

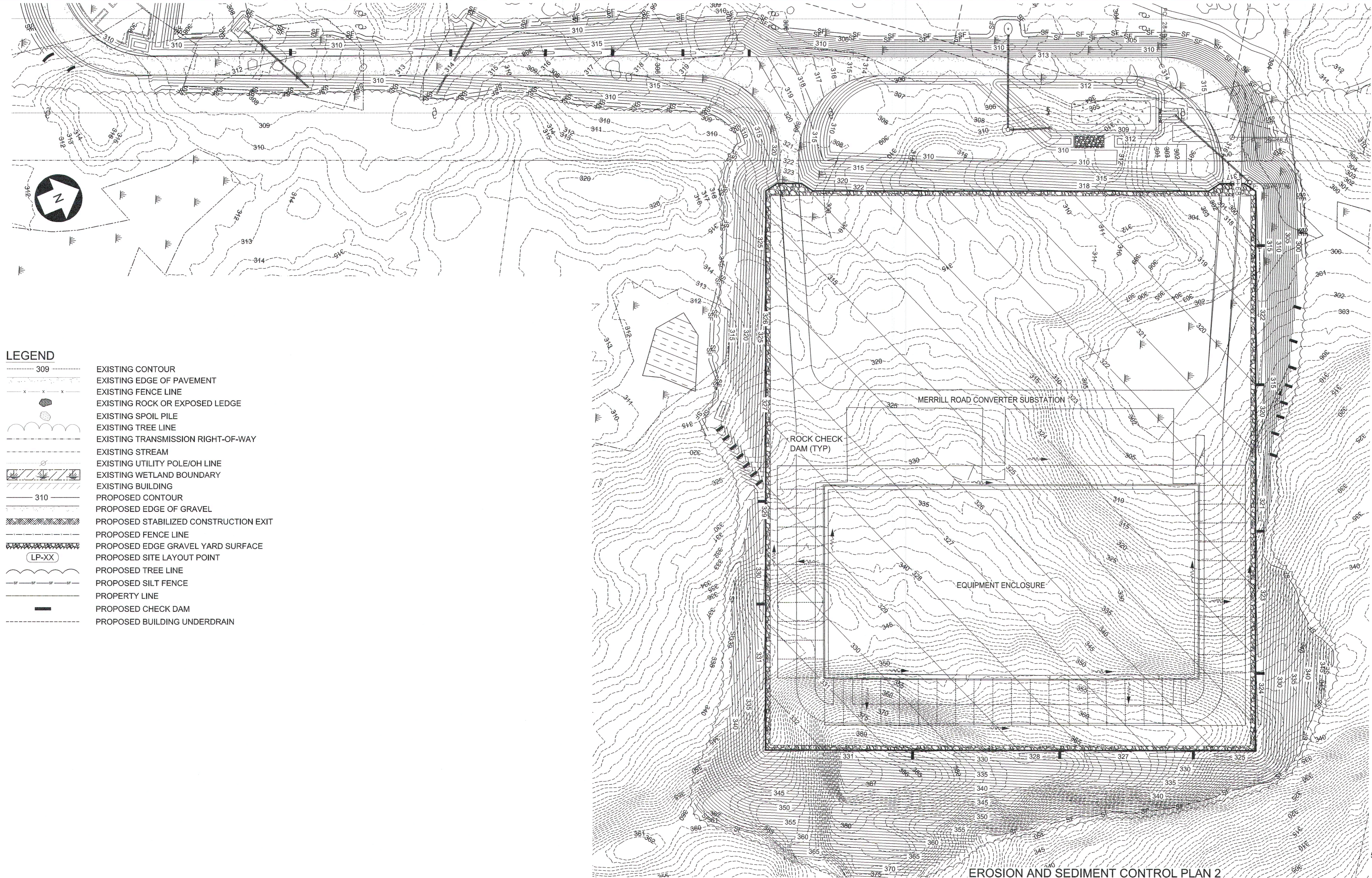

LEGEND

	EXISTING CONTOUR
	EXISTING EDGE OF PAVEMENT
	EXISTING FENCE LINE
	EXISTING ROCK OR EXPOSED LEDGE
	EXISTING SPOIL PILE
	EXISTING TREE LINE
	EXISTING TRANSMISSION RIGHT-OF-WAY
	EXISTING STREAM
	EXISTING UTILITY POLE/OH LINE
	EXISTING WETLAND BOUNDARY
	EXISTING BUILDING
	PROPOSED CONTOUR
	PROPOSED EDGE OF GRAVEL
	PROPOSED STABILIZED CONSTRUCTION EXIT
	PROPOSED FENCE LINE
	PROPOSED EDGE GRAVEL YARD SURFACE
	PROPOSED SITE LAYOUT POINT
	PROPOSED TREE LINE
	PROPOSED SILT FENCE
	PROPERTY LINE
	PROPOSED CHECK DAM
	PROPOSED BUILDING UNDERDRAIN

EROSION AND SEDIMENT CONTROL PLAN 2
SCALE: 1"= 50'

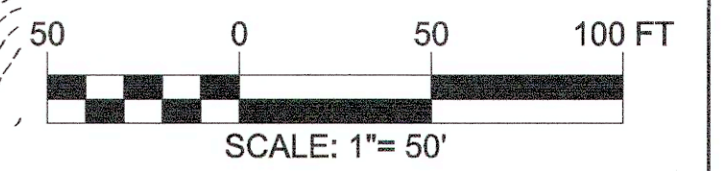

ANSI D CADD Drawing, DO NOT REVISE MANUALLY.

ISSUED FOR REVIEW
NOT FOR CONSTRUCTION
07/12/18

REV.	DESCRIPTION	DATE	BY	CK	APP
B	MEDEP PERMIT SET COMMENT REVISIONS	05/29/18	EVD	KRV	
C	ACCESS ROAD ALIGNMENT REVISIONS	07/12/18	RST	KRV	

OWNER ENGINEER:	APPROVAL STAMP:
DRAWING PREPARED BY:	ACCEPTED BY OE:

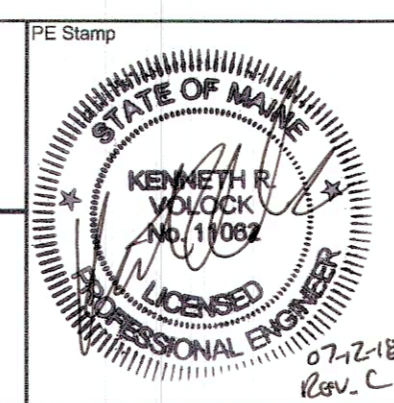

USA ENGINEERING
CONFIDENTIAL, PROPRIETARY and TRADE SECRET INFORMATION
Property of Iberdrola, USA

CMP
IBERDROLA - USA

REV.	DATE	BY	DESCRIPTION	APP.

EROSION AND SEDIMENT CONTROL PLAN 2
SH 2 OF 2

MERRILL ROAD/1076 **LEWISTON, ME**

DR. EVD SCALE: 1"=100' FILE: 1076-003-003SH002.DWG
CK. KRV NO. 1076-003-003 REV. C
APP. DATE: 07/12/18

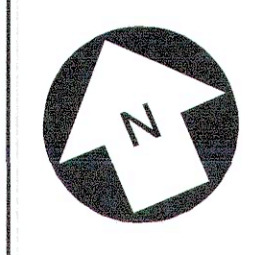

FOR CONTINUATION-REFER TO
DRAWING 1076-003-004 SH 002

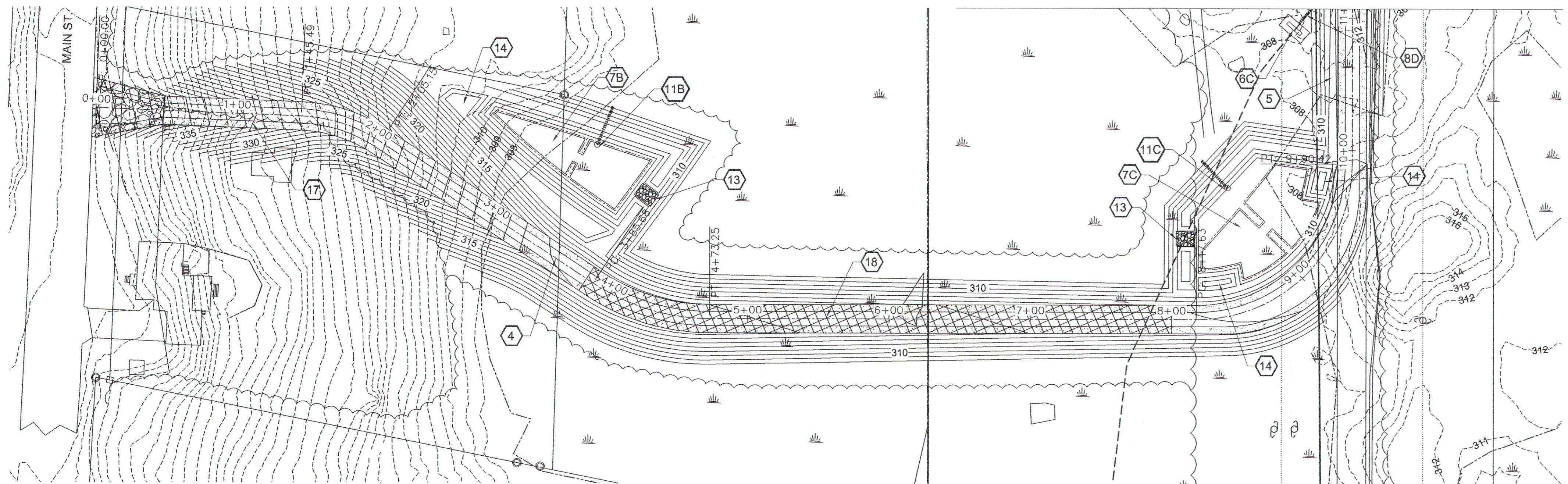

ROAD PLAN STATION 0+00 TO 11+00
SCALE: 1"= 50'

LEGEND

	EXISTING CONTOUR
	EXISTING EDGE OF PAVEMENT
	EXISTING FENCE LINE
	EXISTING ROCK OR EXPOSED LEDGE
	EXISTING SPOIL PILE
	EXISTING TREE LINE
	EXISTING TRANSMISSION RIGHT-OF-WAY
	EXISTING STREAM
	EXISTING UTILITY POLE/OH LINE
	EXISTING WETLAND BOUNDARY
	EXISTING BUILDING
	PROPOSED CONTOUR
	PROPOSED EDGE OF GRAVEL
	PROPOSED GRAVEL ACCESS RAMP
	PROPOSED FENCE LINE
	PROPOSED STABILIZED CONSTRUCTION EXIT
	PROPOSED SITE LAYOUT POINT
	PROPOSED TREE LINE
	PROPOSED SILT FENCE
	PROPERTY LINE
	PROPOSED CHECK DAM
	LIMIT OF CONSTRUCTION
	LIMIT OF FOUNDATION CONSTRUCTION
	PROPOSED GRAVEL BASE DRAINAGE BLANKET

- NOTES:**
- TOPOGRAPHIC SURVEY PERFORMED BY SACKETT & BRAKE SURVEY, INC. DATED JUNE 12, 2017. HORIZONTAL DATUM - NAD83 MAINE STATE PLANE COORDINATE SYSTEM, WEST ZONE, US SURVEY FEET, VERTICAL DATUM-NAVD88 FEET.
 - ADDITIONAL TRANSMISSION LINE REFERENCE DRAWINGS, 1011-T200-24 AND 1011-T251-023.

- WORK NOTES**
- 4 GRAVEL ACCESS ROAD - SEE DETAIL, DWG 1076-003-005 SHEET 1.
 - 5 VEGETATED DRAINAGE SWALE - SEE DETAIL, DWG 1076-003-005 SHEET 1.
 - 6C LEVEL SPREADER LS-4 - SEE DETAIL, DWG 1076-003-005 SHEET 2.
 - 7B GRAVEL WETLAND #1 - SEE DETAIL, DWG 1076-003-002 SHEET 5.
 - 7C GRAVEL WETLAND #2 - SEE DETAIL, DWG 1076-003-002 SHEET 5.
 - 8D 18" CULVERT PIPE - INV. IN = 308.0', INV. OUT = 307.75'
 - 11B GRAVEL WETLAND OUTLET STRUCTURE #1 - SEE DETAIL, DWG. 1076-003-002 SHEET 5.
 - 11C GRAVEL WETLAND OUTLET STRUCTURE #2 - SEE DETAIL, DWG. 1076-003-002 SHEET 5.
 - 13 EMERGENCY SPILLWAY - SEE DETAIL, DWG. 1076-003-002 SHEET 2.
 - 14 STONE FOREBAY - SEE DETAIL, DWG. 1076-003-002 SHEET 2.
 - 17 SECURITY GATE - SEE DETAIL, 1076-003-005 SHEET 3.
 - 18 WETLAND ROAD CROSSING W/ PERMEABLE ROAD BASE - SEE DETAIL, 1076-003-005 SHEET 5.

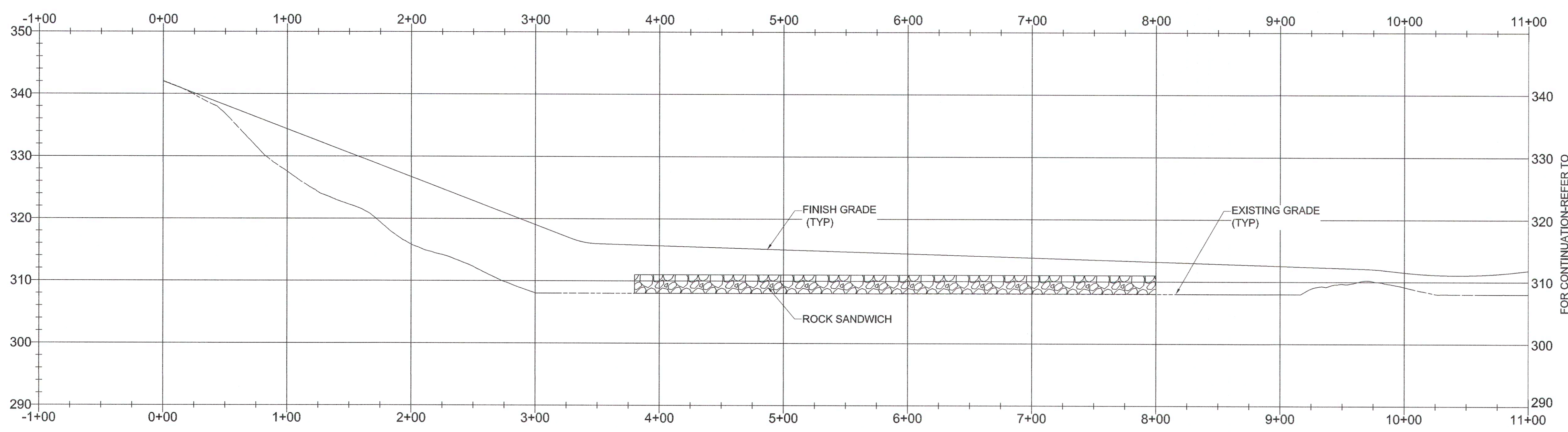

ROAD PROFILE STATION 0+00 TO 11+00
SCALE HORIZ: 1"= 50'
VERT: 1"= 5'

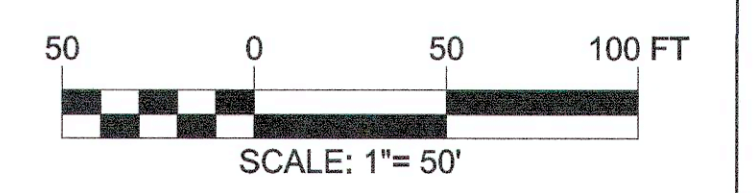

ANSI D Drawing. DO NOT REVISE MANUALLY.

**ISSUED FOR PERMITTING
NOT FOR CONSTRUCTION
07/12/18**

REV.	DESCRIPTION	DATE	BY	CK	APP
B	ACCESS ROAD ALIGNMENT REVISIONS	07/12/18	RST	KRV	

OWNER ENGINEER: _____ APPROVAL STAMP: _____ PE Stamp: _____

DRAWING PREPARED BY: _____ ACCEPTED BY OE: _____

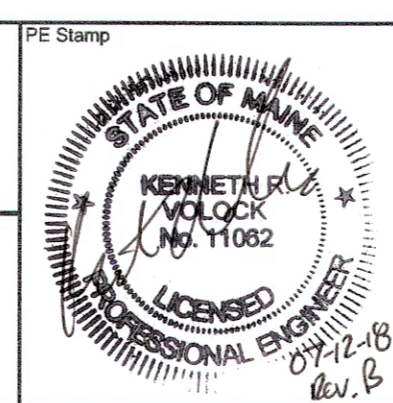

IUSA ENGINEERING
CONFIDENTIAL, PROPRIETARY and TRADE SECRET INFORMATION
Property of Iberdrola, USA

CMP
IBERDROLA - USA

REV.	DATE	BY	DESCRIPTION	APP.

ROAD PLAN AND PROFILE 1

SH 1 OF 2

MERRILL ROAD/1076 LEWISTON, ME

SCALE: 1"=50' FILE: 1076-003-004SH001.DWG

NO. 1076-003-004 REV. B



FOR CONTINUATION-REFER TO
DRAWING 1076-003-004 SH 001

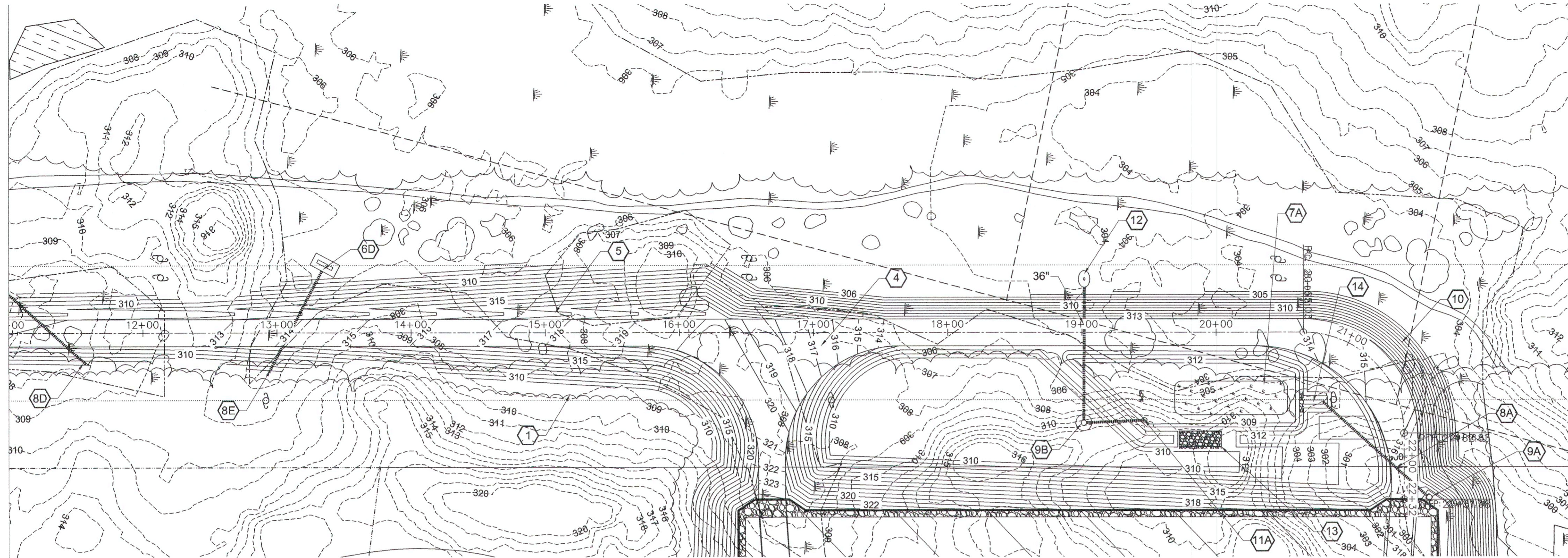

ROAD PLAN STATION 11+00 TO 22+31.98
SCALE: 1"= 50'

LEGEND

- - - 309 - - - EXISTING CONTOUR
- - - - - EXISTING EDGE OF PAVEMENT
- - - - - EXISTING FENCE LINE
- ⊗ EXISTING ROCK OR EXPOSED LEDGE
- ⊗ EXISTING SPOIL PILE
- ⊗ EXISTING TREE LINE
- - - - - EXISTING TRANSMISSION RIGHT-OF-WAY
- - - - - EXISTING STREAM
- - - - - EXISTING UTILITY POLE/OH LINE
- ▨ EXISTING WETLAND BOUNDARY
- ▭ EXISTING BUILDING
- - - - - PROPOSED CONTOUR
- - - - - 310 - - - PROPOSED EDGE OF GRAVEL
- ▨ PROPOSED GRAVEL ACCESS RAMP
- ▨ PROPOSED FENCE LINE
- ▨ PROPOSED STABILIZED CONSTRUCTION EXIT
- ⊗ LP-XX PROPOSED SITE LAYOUT POINT
- - - - - PROPOSED TREE LINE
- - - - - PROPOSED SILT FENCE
- - - - - PROPERTY LINE
- ▬ PROPOSED CHECK DAM

NOTES:

1. TOPOGRAPHIC SURVEY PERFORMED BY SACKETT & BRAKE SURVEY, INC. DATED JUNE 12, 2017. HORIZONTAL DATUM - NAD83 MAINE STATE PLANE COORDINATE SYSTEM, WEST ZONE, US SURVEY FEET, VERTICAL DATUM-NAVD88 FEET.
2. ADDITIONAL TRANSMISSION LINE REFERENCE DRAWINGS, 1011-T200-24 AND 1011-T251-023.

WORK NOTES

- 1 PROPOSED TREE LINE.
- 4 GRAVEL ACCESS ROAD - SEE DETAIL, DWG 1076-003-005 SHEET 1.
- 5 VEGETATED DRAINAGE SWALE - SEE DETAIL, DWG 1076-003-005 SHEET 1.
- 6D LEVEL SPREADER LS-3 - SEE DETAIL, DWG 1076-003-005 SHEET 2.
- 7A GRASSED UNDERDRAIN SOIL FILTER #1 - SEE DETAIL, DWG 1076-003-002 SHEET 2.
- 8A 24" CULVERT PIPE - INV IN = 312.0', INV OUT = 310.0'
- 8B 24" CULVERT PIPE - INV IN = 305.60', INV OUT = 305.30'
- 8C 36" CULVERT PIPE - INV IN = 305.30', INV OUT = 305.00'
- 8D 18" CULVERT PIPE - INV. IN = 308.80', INV. OUT = 307.75'
- 8E 15" CULVERT PIPE - INV. IN = 307.0', INV. OUT = 306.25'
- 9A CATCH BASIN, CB-2 - RIM ELEV. = 316.0', SEE DETAIL DWG 1076-003-002 SHEET 2.
- 9B CATCH BASIN/SEDIMENT BASIN OUTLET STRUCTURE, CB-1 - SEE DETAIL DWG 1076-003-002 SHEET 2.
- 10 ALL SLOPES GREATER THAN 3 TO 1 SHALL RECEIVE EROSION CONTROL BLANKET - SEE DETAIL DWG 1076-003-005 SHEET 4.
- 11A SOIL FILTER OUTLET STRUCTURE #1 - SEE DETAIL, DWG. 1076-003-002 SHEET 2.
- 12 RIP RAP PLUNGE POOL - SEE DETAIL, DWG. 1076-003-005 SHEET 2.
- 13 EMERGENCY SPILLWAY - SEE DETAIL, DWG. 1076-003-002 SHEET 2.
- 14 STONE FOREBAY - SEE DETAIL, DWG. 1076-003-002 SHEET 2.

FOR CONTINUATION-REFER TO
DRAWING 1076-003-004 SH 001

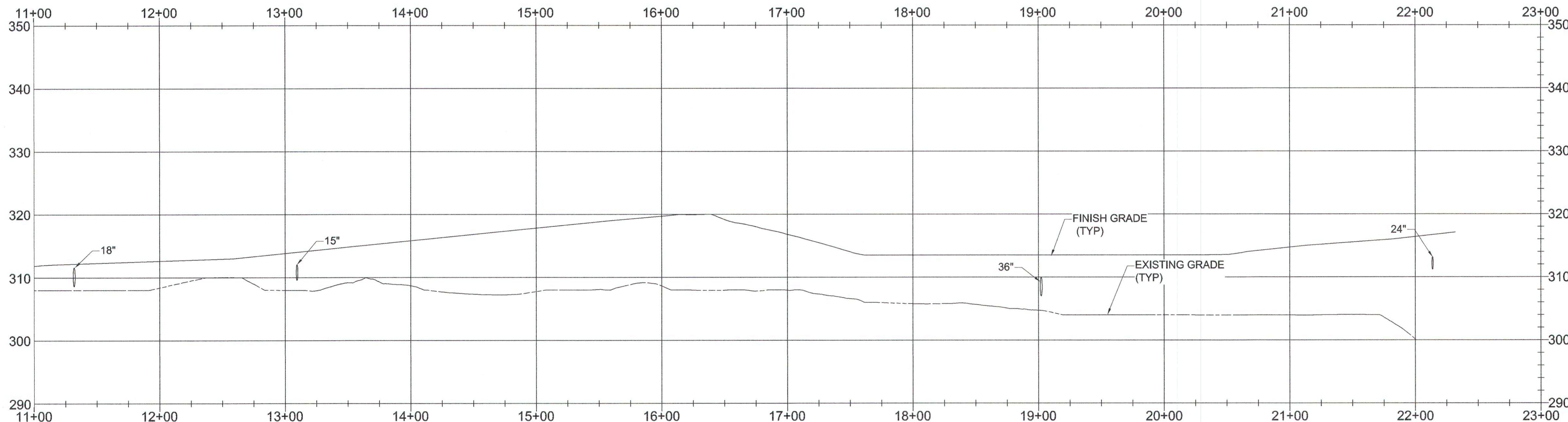

ROAD PROFILE STATION 11+00 TO 22+31.98

SCALE HORIZ: 1"= 50'
VERT: 1"= 10'

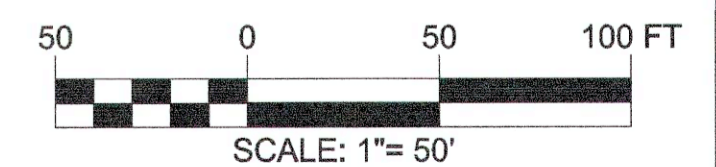

ANSI D CADD Drawing, DO NOT REVISE MANUALLY.

**ISSUED FOR PERMITTING
NOT FOR CONSTRUCTION
07/12/18**

REV.	DESCRIPTION	DATE	BY	CK	APP
B	ACCESS ROAD ALIGNMENT REVISIONS	07/12/18	RST	KRV	

OWNER ENGINEER: _____ APPROVAL STAMP: _____

DRAWING PREPARED BY: _____ ACCEPTED BY OE: _____

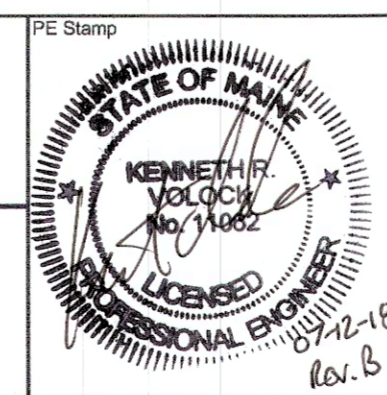

IUSA ENGINEERING
CONFIDENTIAL, PROPRIETARY and TRADE SECRET INFORMATION
Property of Iberdrola, USA

CMP
IBERDROLA - USA

ROAD PLAN AND PROFILE 2

SH 2 OF 2

MERRILL ROAD/1076 **LEWISTON, ME**

DR: EVD SCALE: NO. FILE: 1076-003-004SH02.DWG
CK: KRV
APP: _____
DATE: _____

1076-003-004 REV. B

REV.	DATE	BY	DESCRIPTION	APP.	DATE

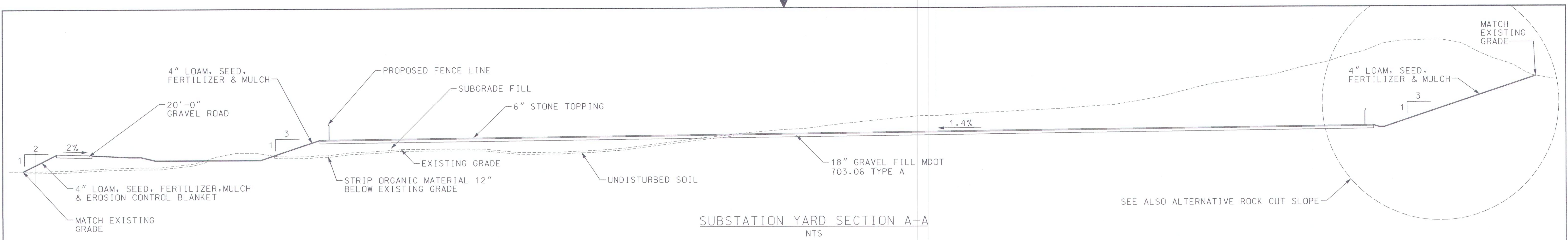

SUBSTATION YARD SECTION A-A
NTS

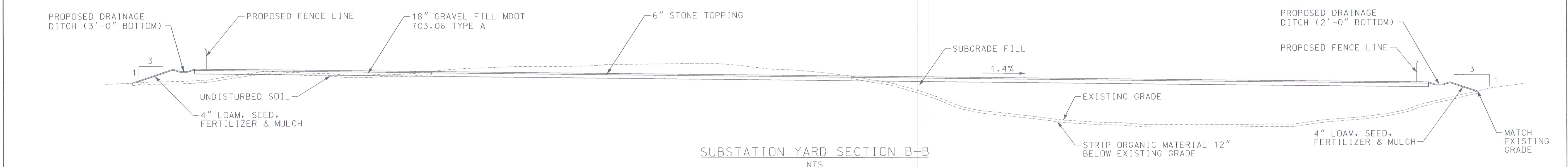

SUBSTATION YARD SECTION B-B
NTS

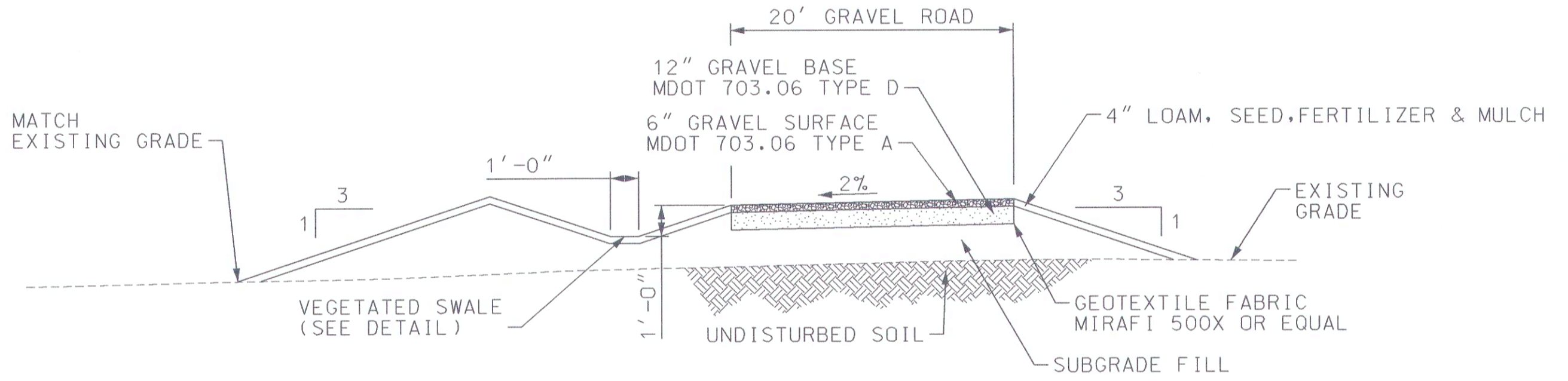

TYPICAL GRAVEL ACCESS ROAD SECTION
NTS

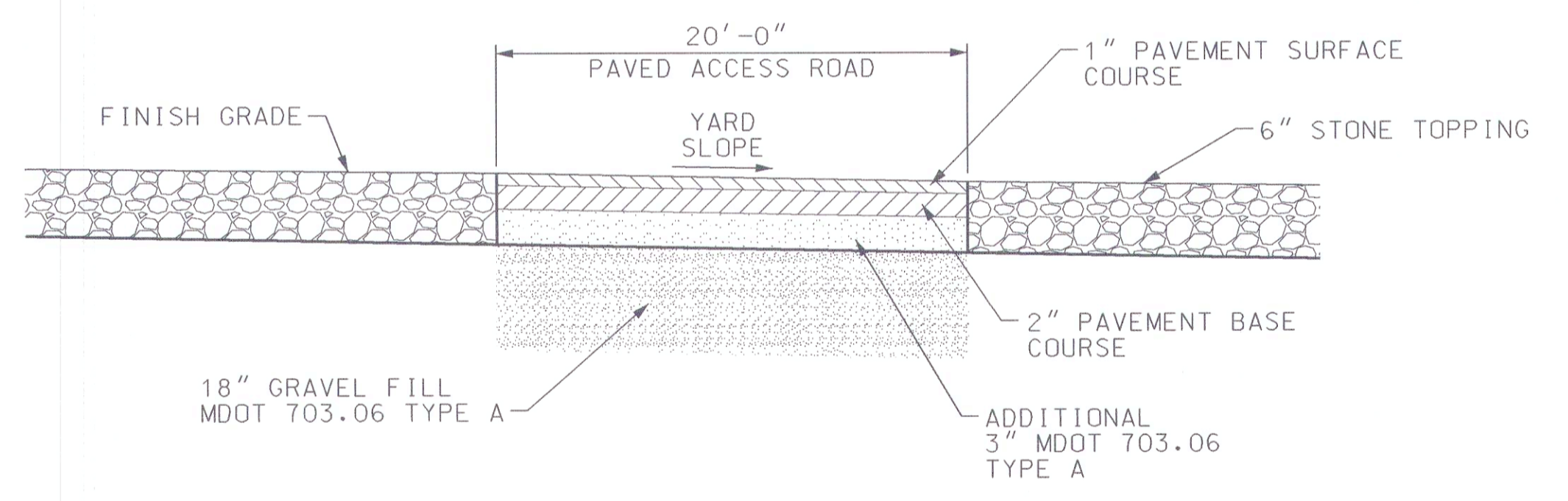

TYPICAL PAVED ROADWAY SECTION
NTS

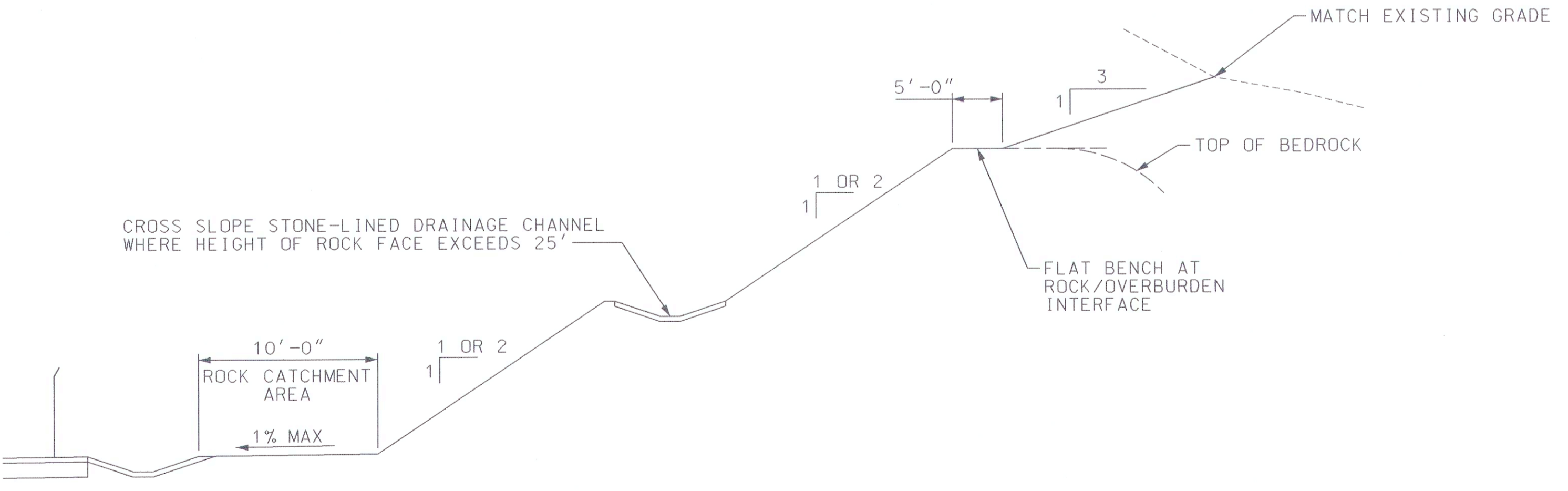

ALTERNATIVE ROCK CUT SLOPE
NTS

- NOTES:**
1. FILL SLOPES SHALL BE CONSTRUCTED AS LEVEL BENCHES WHICH ARE OVERBUILT TO FACILITATE COMPACTION. THE FINAL SLOPE FACE SHALL BE CONSTRUCTED BY CUTTING BACK INTO THE COMPACTED CORE.
 2. WHERE GREATER THAN 4'-0" OF FILL IS REQUIRED, SUBSTATION YARD SHALL BE FILLED TO 4'-0" BELOW GRADES SHOWN ON THE GRADING PLAN WITH SUBGRADE FILL. FROM 4'-0" BELOW TO GRADE, FILL SHALL BE GRAVEL BORROW.

ANSI D - CADD Drawing. DO NOT REVISE MANUALLY.

**ISSUED FOR PERMITTING
NOT FOR CONSTRUCTION
08/09/18**

REV.	DESCRIPTION	DATE	BY	CK	APP
B	MDEP PERMIT SET COMMENT REVISION	08/09/18	RST	KRV	

OWNER ENGINEER: _____
APPROVAL STAMP: _____
DRAWING PREPARED BY: _____
ACCEPTED BY OE: _____

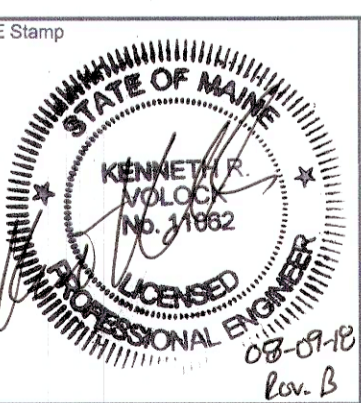

IUSA ENGINEERING
CONFIDENTIAL, PROPRIETARY and TRADE SECRET INFORMATION
Property of Iberdrola, USA

CMP
IBERDROLA - USA

SITE DETAILS 1

SH 1 OF 6

MERRILL ROAD/1076 LEWISTON, ME

DR.	END	SCALE: AS NOTED	FILE: 1076-003-005SH001.DWG
CK.	KRV	NO.	
APP.			
REV.			

1076-003-005 B

REV.	DATE	BY	DESCRIPTION	APP.	DATE:

LEVEL SPREADER CHART			
ID	LENGTH (A)	INVERT (B)	DEPTH (C)
LS-1	10'-0"	298.00'	1'-0"
LS-2	10'-0"	315.00'	1'-0"
LS-3	10'-0"	306.25'	1'-0"
LS-4	10'-0"	307.75'	1'-0"

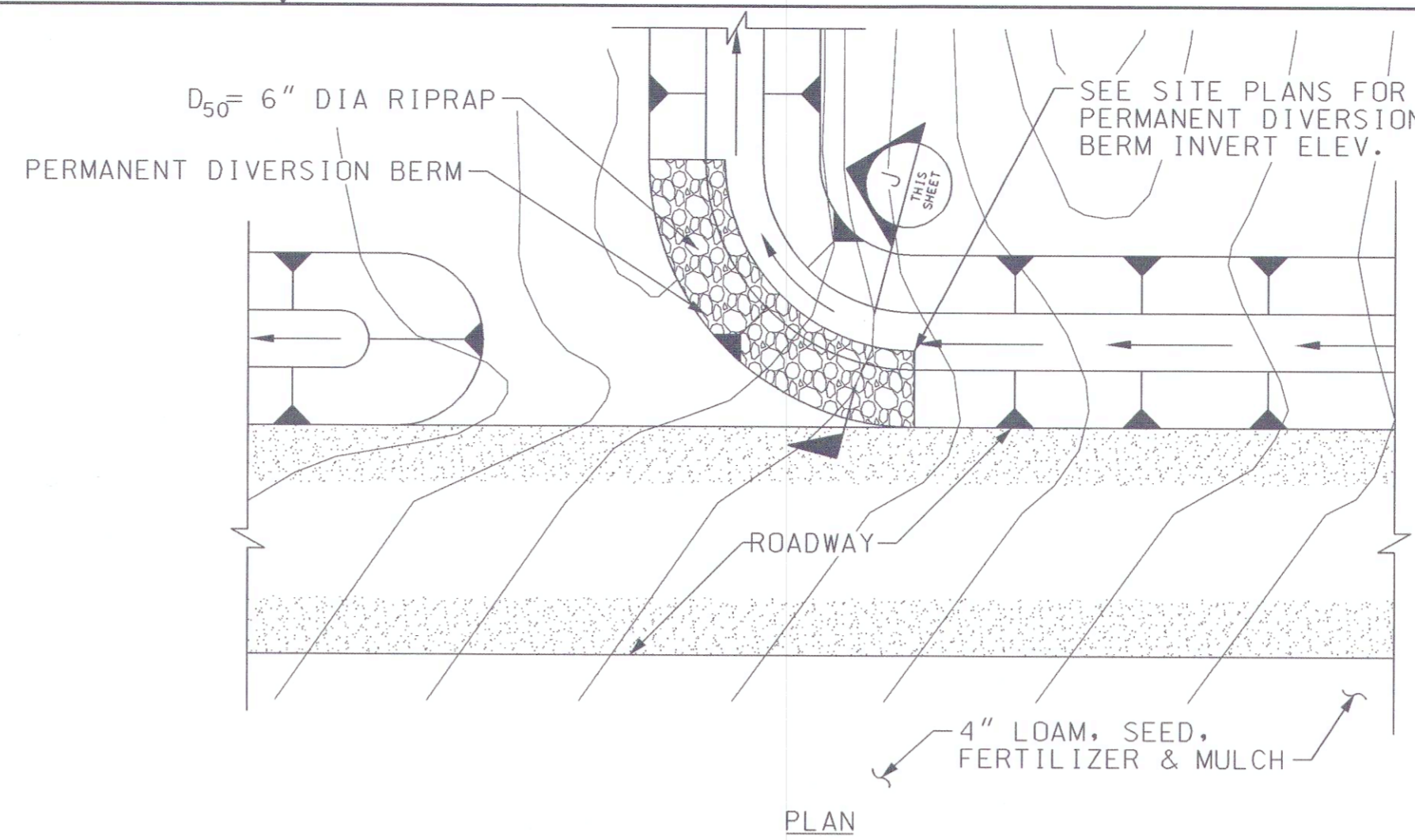
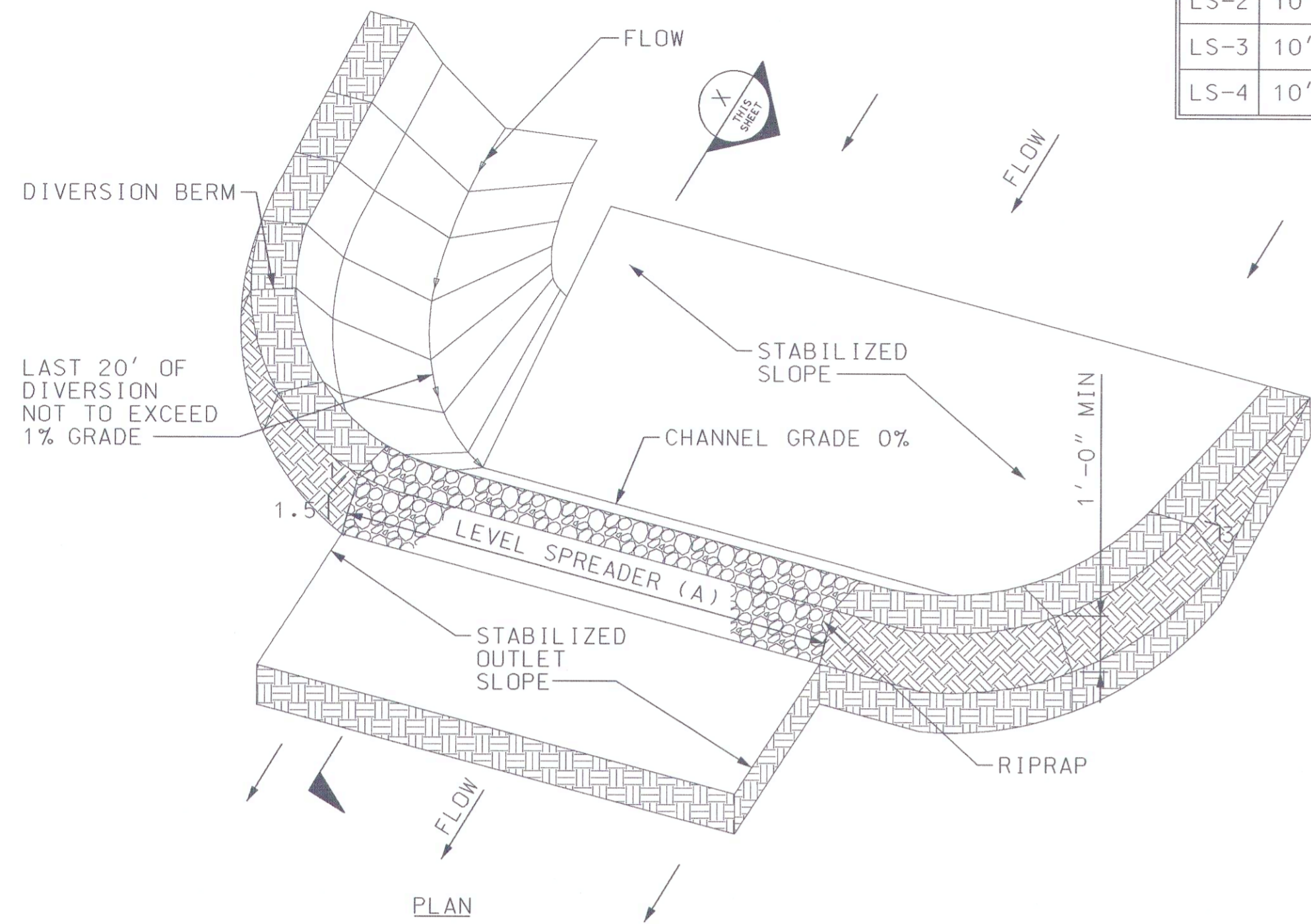

PERMANENT DIVERSION BERM DETAIL
NTS

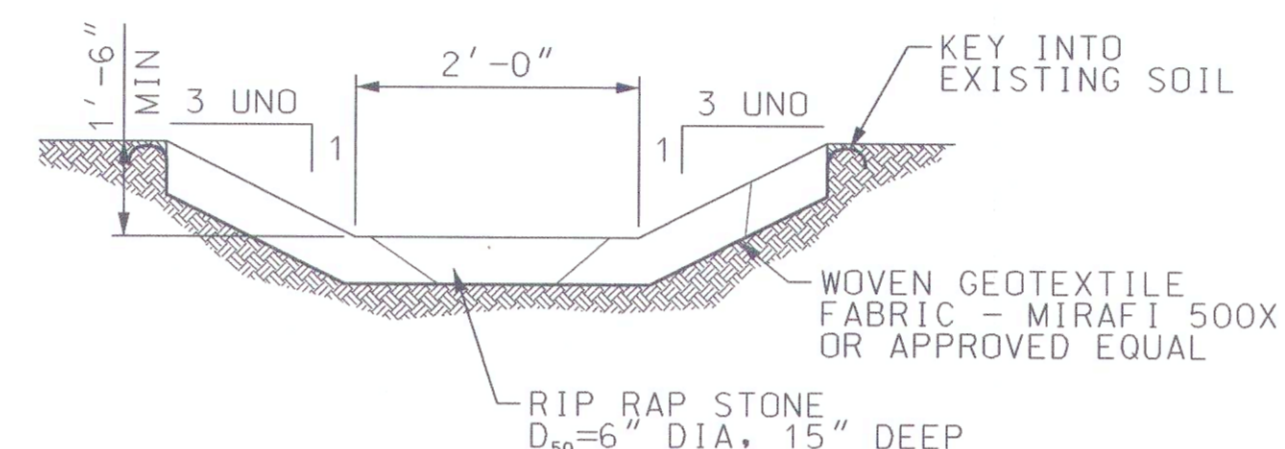
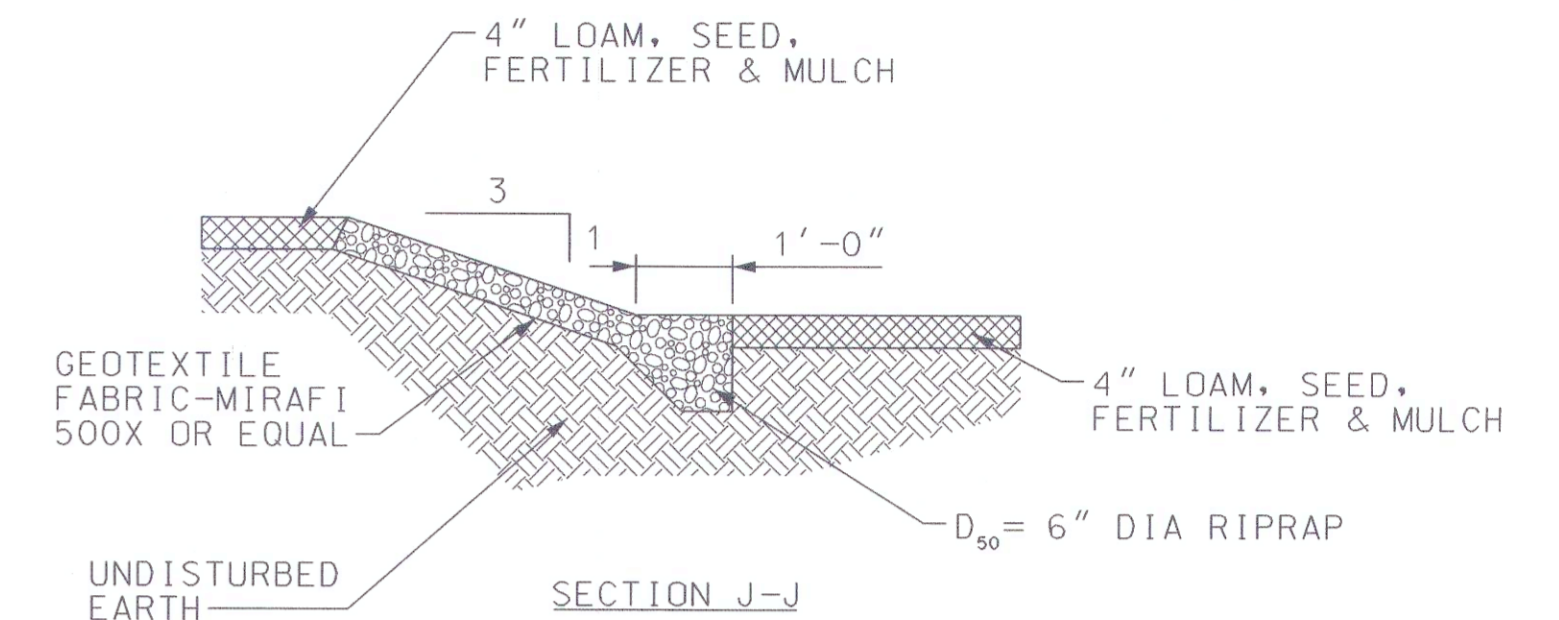

TYPICAL RIPRAP DRAINAGE SWALE
NTS

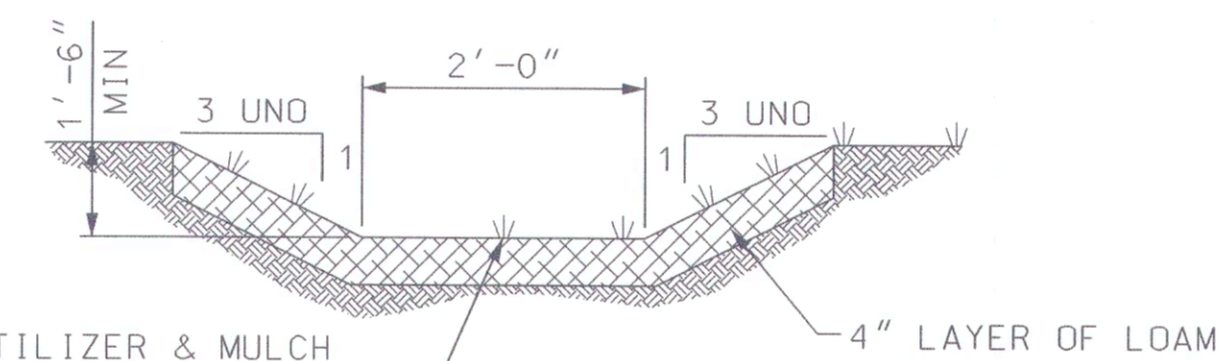

TYPICAL VEGETATED DRAINAGE SWALE
NTS

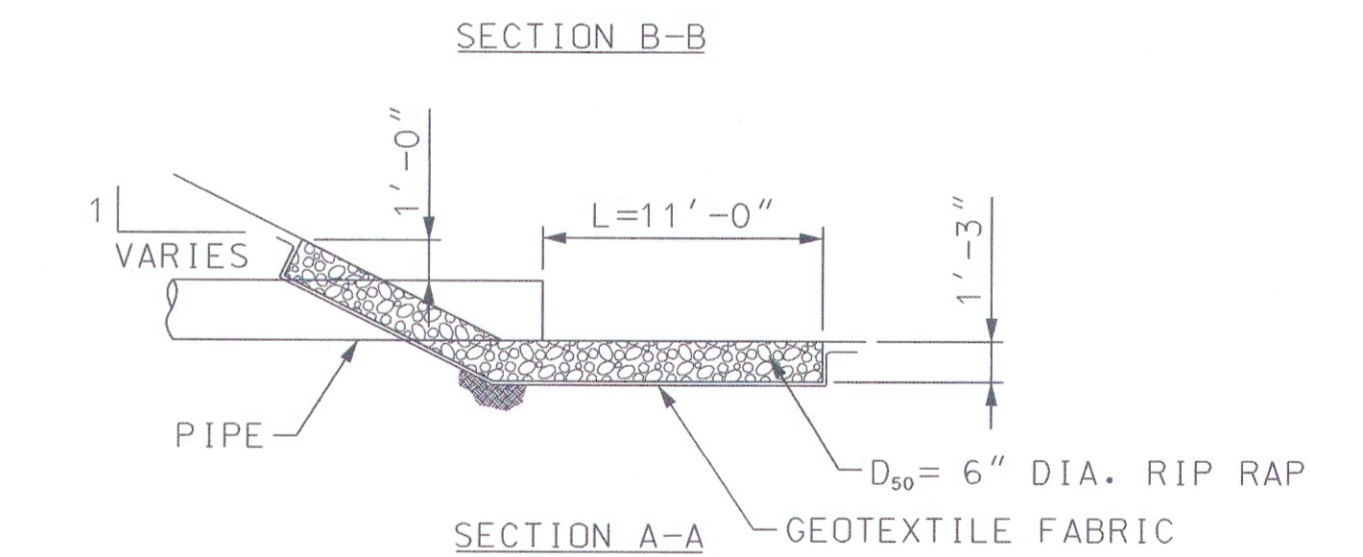
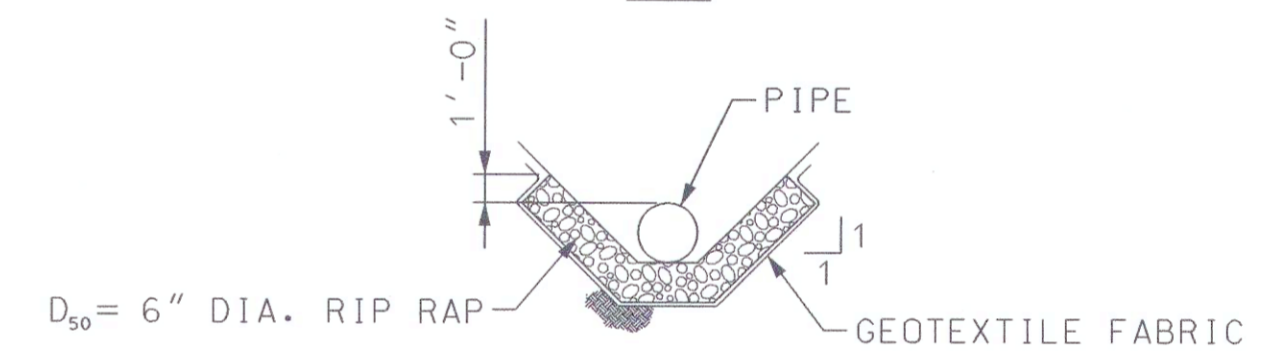
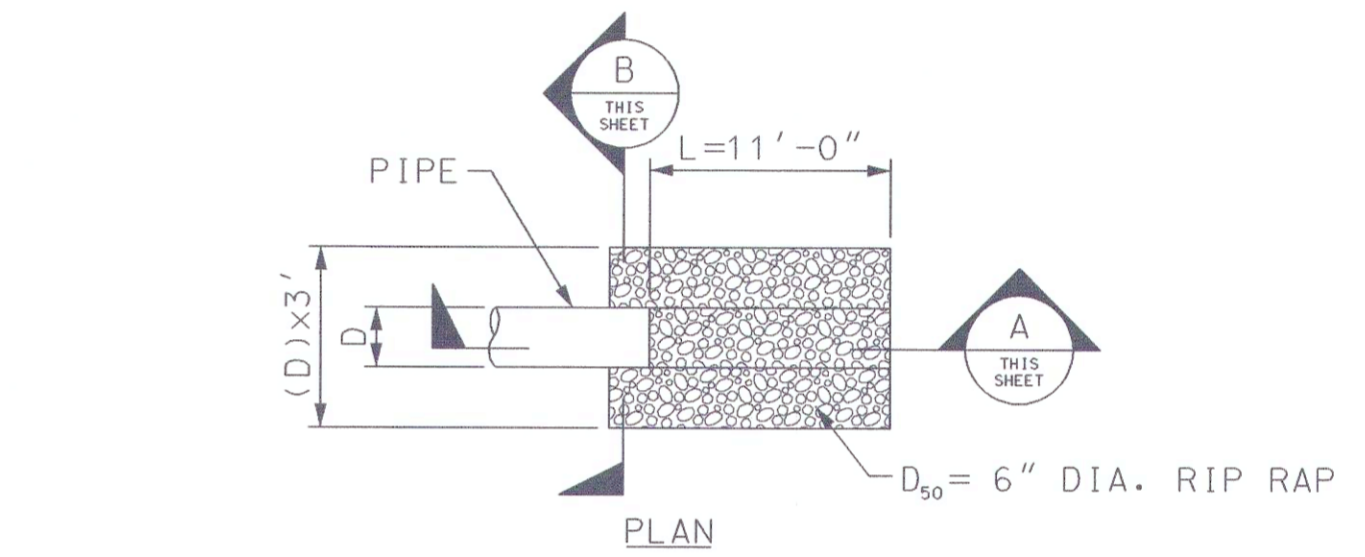

CULVERT INLET/OUTLET PROTECTION
NOT TO SCALE

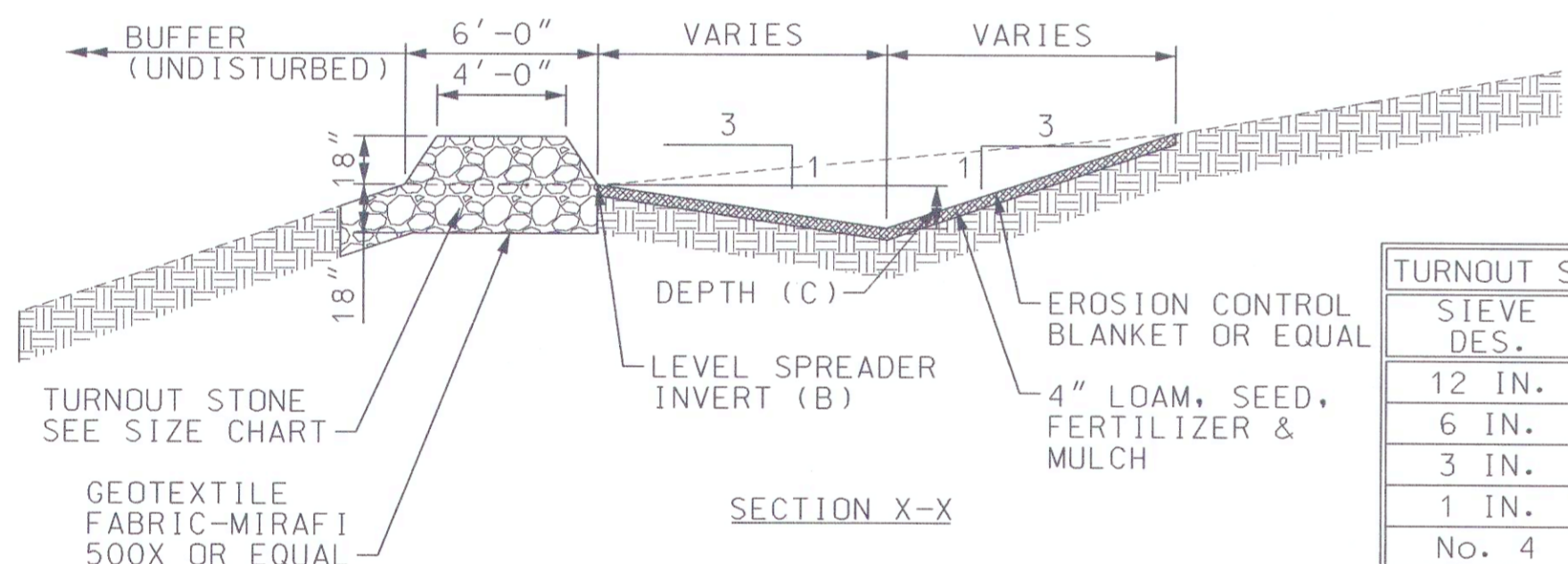

LEVEL SPREADER DETAIL
NTS

TURNOUT STONE SIZE	
SIEVE DES.	% PASSING BY WEIGHT
12 IN.	100
6 IN.	84-100
3 IN.	68-83
1 IN.	42-55
No. 4	8-12

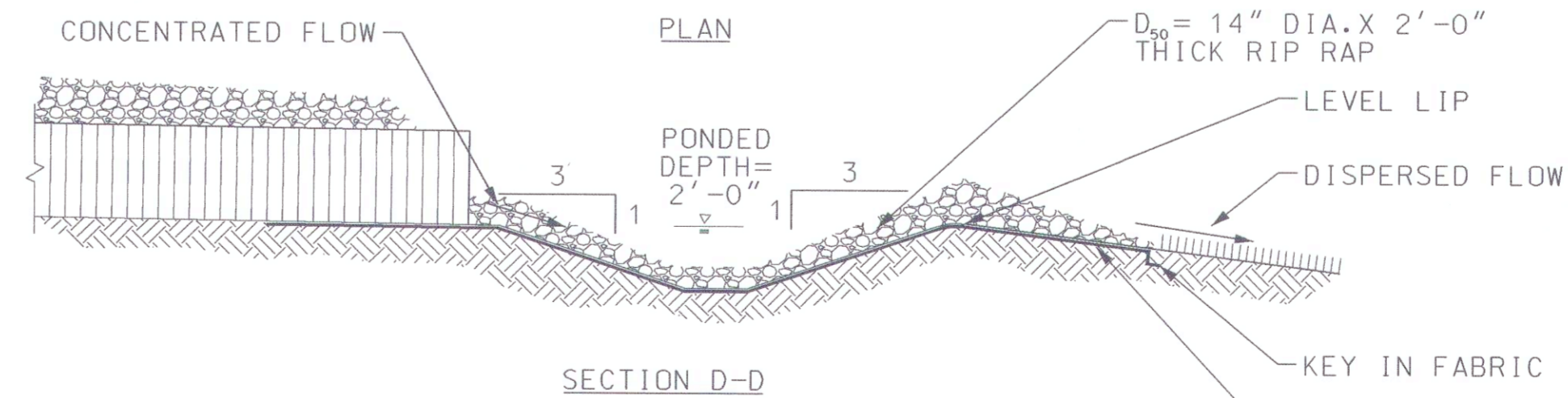
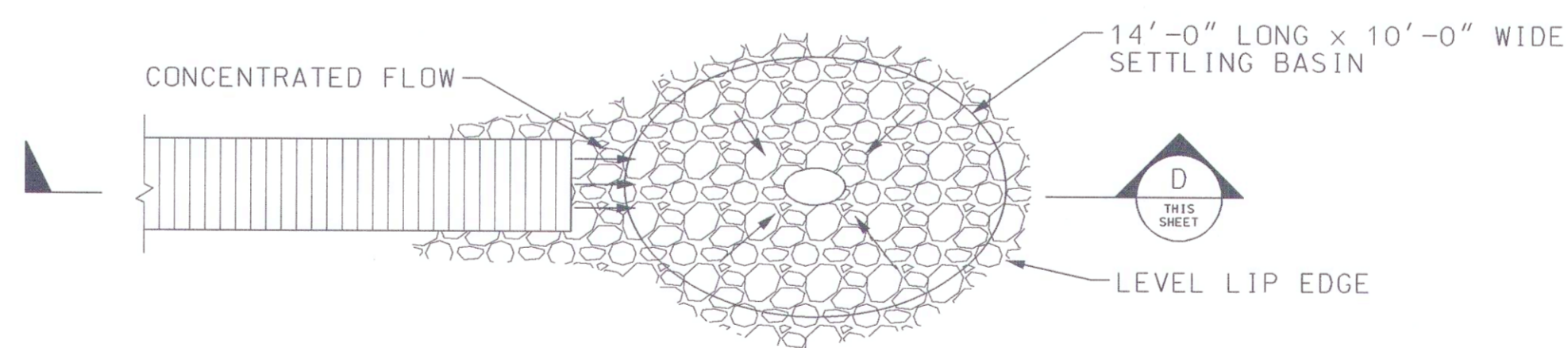

RIP RAP PLUNGE POOL DETAIL
NOT TO SCALE

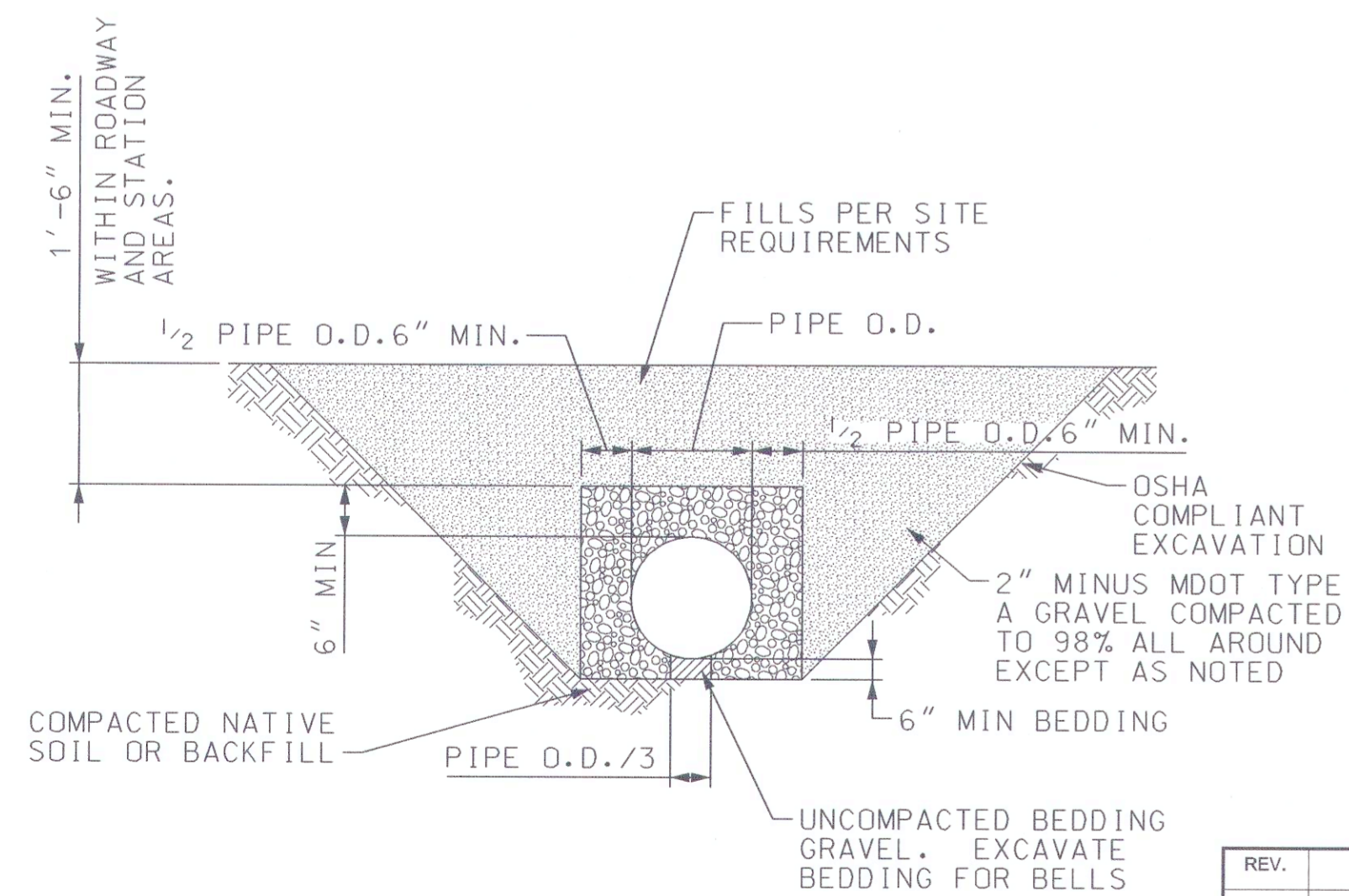

TYPICAL CULVERT SECTION
NOT TO SCALE

**ISSUED FOR PERMITTING
NOT FOR CONSTRUCTION
08/09/18**

REV.	DESCRIPTION	DATE	BY	CK	APP	OWNER ENGINEER:	APPROVAL STAMP:	PE Stamp:	IUSA ENGINEERING CONFIDENTIAL, PROPRIETARY and TRADE SECRET INFORMATION Property of Iberdrola, USA	CMP IBERDROLA - USA	SITE DETAILS 2
B	MDEP PERMIT SET COMMENT REVISIONS	08/09/18	RST	KRV							SH 2 OF 6
MERRILL ROAD/1076 LEWISTON, ME											
DR.	EVD	SCALE: AS NOTED	FILE: 1076-003-005SH002.DWG								
CK.	KRV	NO.									
APP.											
DATE:											
REV.	DATE	BY	DESCRIPTION	APP.	DATE:						

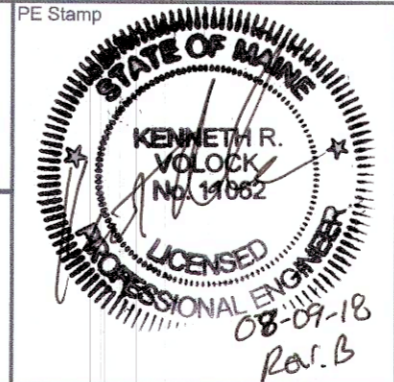

ANSI D CADD Drawing, DO NOT REVISE MANUALLY.

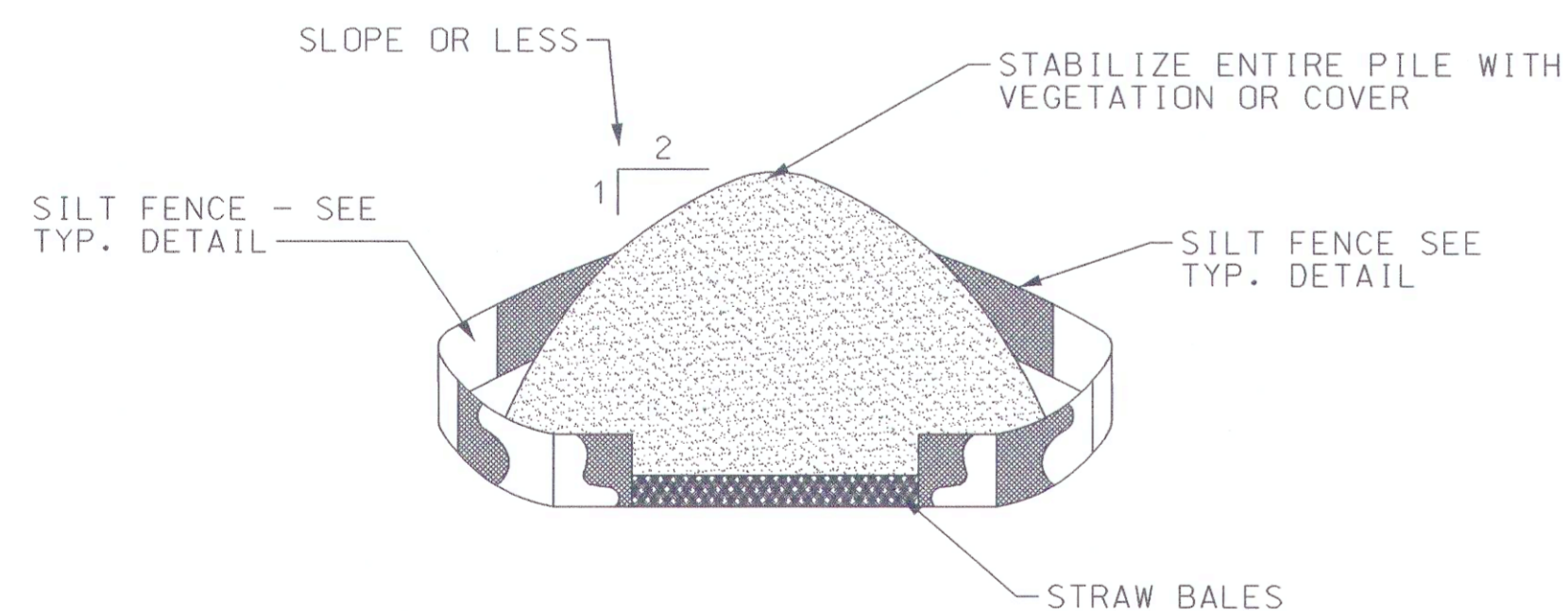
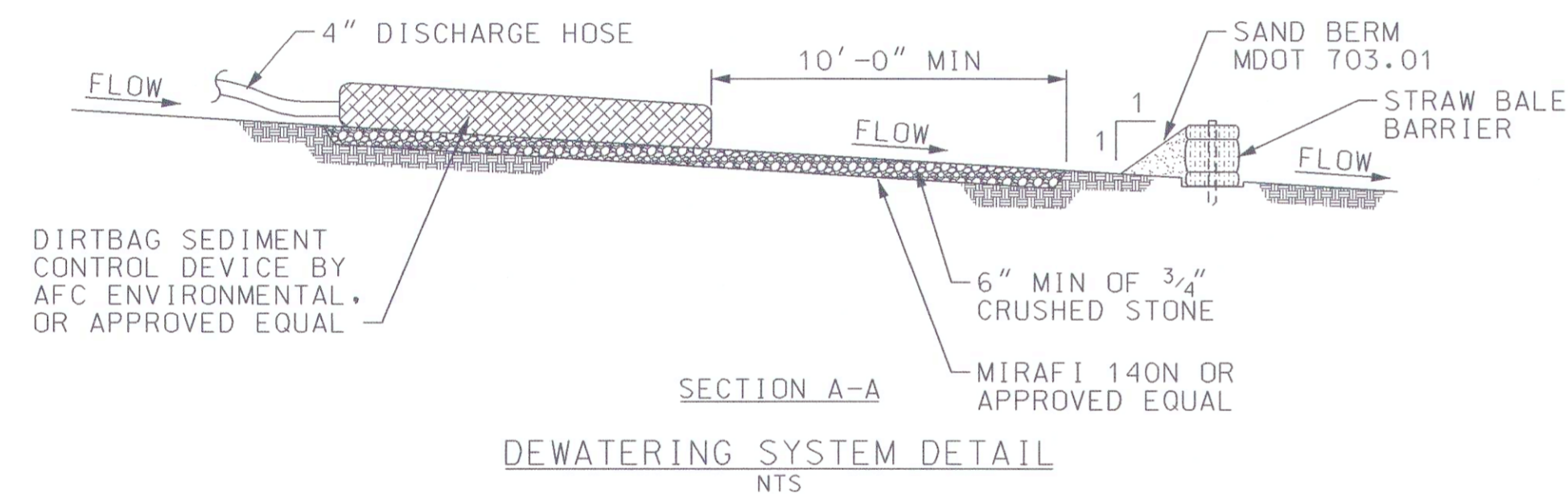
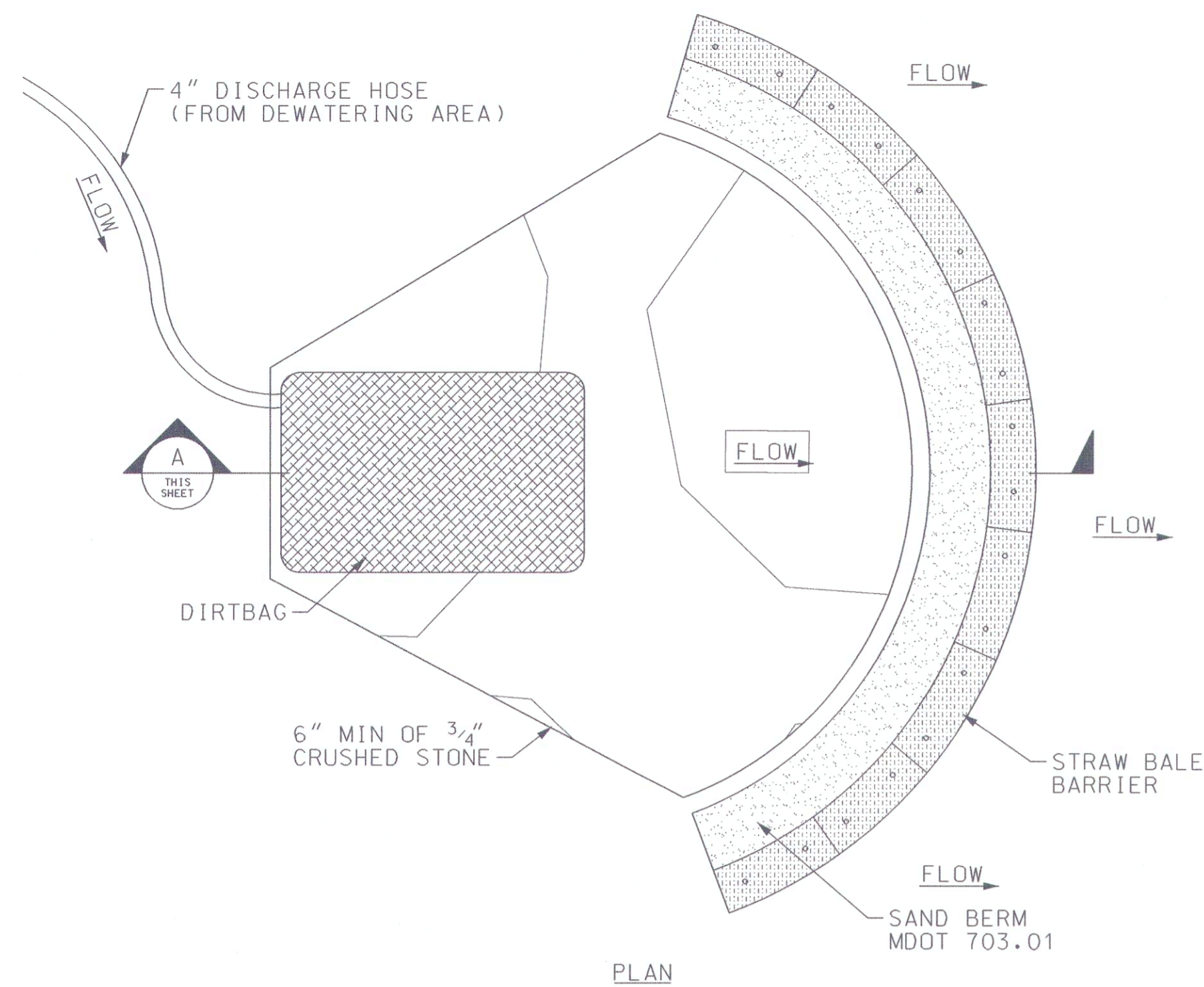

DEWATERING NOTES:

1. THE CONTRACTOR SHALL INSTALL, MAINTAIN, AND OPERATE ALL CHANNELS, SUMPS, AND ALL OTHER TEMPORARY DIVERSION AND PROTECTIVE WORKS NEEDED TO DIVERT STREAM FLOW AND OTHER SURFACE WATER THROUGH OR AROUND THE CONSTRUCTION SITE. CONTROL OF SURFACE WATER SHALL BE CONTINUOUS DURING THE PERIOD THAT DAMAGE TO CONSTRUCTION WORK COULD OCCUR.
2. OPEN EXCAVATIONS SHALL BE DEWATERED AND KEPT FREE OF STANDING WATER AND MUDDY CONDITIONS AS NECESSARY FOR THE PROPER EXECUTION OF THE WORK. THE CONTRACTOR SHALL FURNISH, INSTALL, OPERATE, AND MAINTAIN ALL DRAINS, SUMPS AND ALL OTHER EQUIPMENT REQUIRED TO PROPERLY DEWATER THE SITE. DEWATERING SYSTEMS THAT CAUSE A LOSS OF SOIL FINES FROM THE FOUNDATION AREAS WILL NOT BE PERMITTED.
3. INSTALL DIVERSION DITCHES OR BERMS IF NECESSARY TO MINIMIZE THE AMOUNT OF CLEAN STORMWATER RUNOFF ALLOWED INTO THE EXCAVATED AREA.
4. REMOVAL OF WATER FROM THE CONSTRUCTION SITE SHALL BE ACCOMPLISHED SO THAT EROSION AND THE TRANSPORTING OF SEDIMENT AND OTHER POLLUTANTS ARE MINIMIZED.
5. DISCHARGE DEWATERING EFFLUENT TO AREAS AS INDICATED ON THE SITE GRADING PLAN. DISCHARGE SHALL BE IN SHEET FLOW.
6. DEWATERING IN PERIODS OF INTENSE, HEAVY RAIN, WHEN THE INFILTRATIVE CAPACITY OF THE SOIL IS EXCEEDED, SHALL BE AVOIDED.
7. FLOW TO THE SEDIMENT REMOVAL STRUCTURE MAY NOT EXCEED THE STRUCTURE'S CAPACITY TO SETTLE AND FILTER FLOW OR THE STRUCTURE'S VOLUME CAPACITY.
8. WHEN TEMPORARY WORKS ARE NO LONGER NEEDED, THE CONTRACTOR SHALL REMOVE AND RETURN THE AREA TO A CONDITION SIMILAR TO THAT WHICH EXISTED BEFORE CONSTRUCTION. AREAS WHERE TEMPORARY WORKS WERE LOCATED SHALL BE GRADED FOR SLIGHTLY APPEARANCE WITH NO OBSTRUCTION TO NATURAL SURFACE WATER FLOWS OR THE PROPER FUNCTIONING AND ACCESS TO THE WORKS OF IMPROVEMENT INSTALLED. THE CONTRACTOR SHALL EXERCISE EXTREME CARE DURING THE REMOVAL STAGES TO MINIMIZE THE LOSS OF SOIL SEDIMENT AND DEBRIS THAT WAS TRAPPED DURING CONSTRUCTION.

HOUSEKEEPING PLAN:

(MAINE DEP CHAPTER 500, APPENDIX C)

1. SPILL PREVENTION. CONTROLS MUST BE USED TO PREVENT POLLUTANTS FROM CONSTRUCTION AND WASTE MATERIALS STORED ON SITE TO ENTER STORMWATER, WHICH INCLUDES STORAGE PRACTICES TO MINIMIZE EXPOSURE OF THE MATERIALS TO STORMWATER. THE SITE CONTRACTOR OR OPERATOR MUST DEVELOP, AND IMPLEMENT AS NECESSARY, APPROPRIATE SPILL PREVENTION, CONTAINMENT, AND RESPONSE PLANNING MEASURES. ANY SPILL OR RELEASE OF TOXIC OR HAZARDOUS SUBSTANCES MUST BE REPORTED TO THE MAINE DEPARTMENT OF ENVIRONMENTAL PROTECTION (MDEP). FOR OIL SPILLS, CALL 1-800-482-0777 WHICH IS AVAILABLE 24 HOURS A DAY. FOR SPILLS OF TOXIC OR HAZARDOUS MATERIAL, CALL 1-800-452-4664 WHICH IS AVAILABLE 24 HOURS A DAY. FOR MORE INFORMATION, VISIT THE MDEP'S WEBSITE AT: <http://www.maine.gov/dep/spills/emergspillresp/>
2. GROUNDWATER PROTECTION. DURING CONSTRUCTION, LIQUID PETROLEUM PRODUCTS AND OTHER HAZARDOUS MATERIALS WITH THE POTENTIAL TO CONTAMINATE GROUNDWATER MAY NOT BE STORED OR HANDLED IN AREAS OF THE SITE DRAINING TO AN INFILTRATION AREA. AN "INFILTRATION AREA" IS ANY AREA OF THE SITE THAT BY DESIGN OR AS A RESULT OF SOILS, TOPOGRAPHY AND OTHER RELEVANT FACTORS ACCUMULATES RUNOFF THAT INFILTRATES INTO THE SOIL. DIKES, BERMS, SUMPS, AND OTHER FORMS OF SECONDARY CONTAINMENT THAT PREVENT DISCHARGE TO GROUNDWATER MAY BE USED TO ISOLATE PORTIONS OF THE SITE FOR THE PURPOSES OF STORAGE AND HANDLING OF THESE MATERIALS. ANY PROJECT PROPOSING INFILTRATION OF STORMWATER MUST PROVIDE ADEQUATE PRE-TREATMENT OF STORMWATER PRIOR TO DISCHARGE OF STORMWATER TO THE INFILTRATION AREA, OR PROVIDE FOR TREATMENT WITHIN THE INFILTRATION AREA, IN ORDER TO PREVENT THE ACCUMULATION OF FINES, REDUCTION IN INFILTRATION RATE, AND CONSEQUENT FLOODING AND DESTABILIZATION.
3. FUGITIVE SEDIMENT AND DUST. ACTIONS MUST BE TAKEN TO ENSURE THAT ACTIVITIES DO NOT RESULT IN NOTICEABLE EROSION OF SOILS OR FUGITIVE DUST EMISSIONS DURING OR AFTER CONSTRUCTION. OIL MAY NOT BE USED FOR DUST CONTROL, BUT OTHER WATER ADDITIVES MAY BE CONSIDERED AS NEEDED. A STABILIZED CONSTRUCTION ENTRANCE (SCE) SHOULD BE INCLUDED TO MINIMIZE TRACKING OF MUD AND SEDIMENT. IF OFF-SITE TRACKING OCCURS, PUBLIC ROADS SHOULD BE SWEEP IMMEDIATELY AND NO LESS THAN ONCE A WEEK AND PRIOR TO SIGNIFICANT STORM EVENTS. OPERATIONS DURING DRY MONTHS, THAT EXPERIENCE FUGITIVE DUST PROBLEMS, SHOULD WET DOWN UNPAVED ACCESS ROADS ONCE A WEEK OR MORE FREQUENTLY AS NEEDED WITH A WATER ADDITIVE TO SUPPRESS FUGITIVE SEDIMENT AND DUST.

LACK OF APPROPRIATE POLLUTANT REMOVAL BEST MANAGEMENT PRACTICES (BMPs) MAY RESULT IN VIOLATIONS OF THE GROUNDWATER QUALITY STANDARD ESTABLISHED BY 38 M.R.S.A. SECTION 465-C(1).

DEWATERING A STREAM WITHOUT A PERMIT FROM THE MDEP MAY VIOLATE STATE WATER QUALITY STANDARDS AND THE NATURAL RESOURCES PROTECTION ACT.

HOUSEKEEPING PLAN (CONT):

4. DEBRIS AND OTHER MATERIALS. MINIMIZE THE EXPOSURE OF CONSTRUCTION DEBRIS, BUILDING AND LANDSCAPING MATERIALS, TRASH, FERTILIZERS, PESTICIDES, HERBICIDES, DETERGENTS, SANITARY WASTE AND OTHER MATERIALS TO PRECIPITATION AND STORMWATER RUNOFF. THESE MATERIALS MUST BE PREVENTED FROM BECOMING A POLLUTANT SOURCE.
- TO PREVENT THESE MATERIALS FROM BECOMING A SOURCE OF POLLUTANTS, CONSTRUCTION AND POST-CONSTRUCTION ACTIVITIES RELATED TO A PROJECT MAY BE REQUIRED TO COMPLY WITH APPLICABLE PROVISIONS OF RULES RELATED TO SOLID, UNIVERSAL, AND HAZARDOUS WASTE, INCLUDING, BUT NOT LIMITED TO, THE MAINE SOLID WASTE AND HAZARDOUS WASTE MANAGEMENT RULES; MAINE HAZARDOUS WASTE MANAGEMENT RULES; MAINE OIL CONVEYANCE AND STORAGE RULES; AND MAINE PESTICIDE REQUIREMENTS.
5. EXCAVATION DE-WATERING. EXCAVATION DE-WATERING IS THE REMOVAL OF WATER FROM TRENCHES, FOUNDATIONS, COFFER DAMS, PONDS, AND OTHER AREAS WITHIN THE CONSTRUCTION AREA THAT RETAIN WATER AFTER EXCAVATION. IN MOST CASES THE COLLECTED WATER IS HEAVILY SILTED AND HINDERS CORRECT AND SAFE CONSTRUCTION PRACTICES. THE COLLECTED WATER REMOVED FROM THE PONDED AREA, EITHER THROUGH GRAVITY OR PUMPING, MUST BE SPREAD THROUGH NATURAL WOODED BUFFERS OR REMOVED TO AREAS THAT ARE SPECIFICALLY DESIGNED TO COLLECT THE MAXIMUM AMOUNT OF SEDIMENT POSSIBLE, LIKE A COFFERDAM SEDIMENTATION BASIN. AVOID ALLOWING THE WATER TO FLOW OVER DISTURBED AREAS OF THE SITE. EQUIVALENT MEASURES MAY BE TAKEN IF APPROVED BY THE MDEP.
 6. AUTHORIZED NON-STORMWATER DISCHARGES. IDENTIFY AND PREVENT CONTAMINATION BY NON-STORMWATER DISCHARGES. WHERE ALLOWED NON-STORMWATER DISCHARGES EXIST, THEY MUST BE IDENTIFIED AND STEPS SHOULD BE TAKEN TO ENSURE THE IMPLEMENTATION OF APPROPRIATE POLLUTION PREVENTION MEASURES FOR THE NON-STORMWATER COMPONENT(S) OF THE DISCHARGE. AUTHORIZED NON-STORMWATER DISCHARGES ARE:
 - (A) DISCHARGES FROM FIREFIGHTING ACTIVITY;
 - (B) FIRE HYDRANT FLUSHINGS;
 - (C) VEHICLE WASHWATER IF DETERGENTS ARE NOT USED AND WASHING IS LIMITED TO THE EXTERIOR OF VEHICLES (ENGINE, UNDERCARRIAGE AND TRANSMISSION WASHING IS PROHIBITED);
 - (D) DUST CONTROL RUNOFF IN ACCORDANCE WITH PERMIT CONDITIONS AND PARAGRAPH 3 ABOVE;
 - (E) ROUTINE EXTERNAL BUILDING WASHDOWN, NOT INCLUDING SURFACE PAINT REMOVAL, THAT DOES NOT INVOLVE DETERGENTS;
 - (F) PAVEMENT WASHWATER (WHERE SPILLS/LEAKS OF TOXIC OR HAZARDOUS MATERIALS HAVE NOT OCCURRED, UNLESS ALL SPILLED MATERIAL HAS BEEN REMOVED) IF DETERGENTS ARE NOT USED;
 - (G) UNCONTAMINATED AIR CONDITIONING OR COMPRESSOR CONDENSATE;
 - (H) UNCONTAMINATED GROUNDWATER OR SPRING WATER;
 - (I) FOUNDATION OR FOOTER DRAIN-WATER WHERE FLOWS ARE NOT CONTAMINATED;
 - (J) UNCONTAMINATED EXCAVATION DEWATERING (SEE REQUIREMENTS IN PARAGRAPH 5 ABOVE);
 - (K) POTABLE WATER SOURCES INCLUDING WATERLINE FLUSHINGS; AND LANDSCAPE IRRIGATION.
 7. UNAUTHORIZED NON-STORMWATER DISCHARGES. THE MDEP'S APPROVAL UNDER THIS CHAPTER DOES NOT AUTHORIZE A DISCHARGE THAT IS MIXED WITH A SOURCE OF NONSTORMWATER, OTHER THAN THOSE DISCHARGES IN COMPLIANCE WITH PARAGRAPH 6 ABOVE. SPECIFICALLY, THE MDEP'S APPROVAL DOES NOT AUTHORIZE DISCHARGES OF THE FOLLOWING:
 - (A) WASTEWATER FROM THE WASHOUT OR CLEANOUT OF CONCRETE, STUCCO, PAINT, FORM RELEASE OILS, CURING COMPOUNDS OR OTHER CONSTRUCTION MATERIALS;
 - (B) FUELS, OILS OR OTHER POLLUTANTS USED IN VEHICLE AND EQUIPMENT OPERATION AND MAINTENANCE;
 - (C) SOAPS, SOLVENTS, OR DETERGENTS USED IN VEHICLE AND EQUIPMENT WASHING; AND
 - (D) TOXIC OR HAZARDOUS SUBSTANCES FROM A SPILL OR OTHER RELEASE.

INSTALLATION NOTES:

1. AREA CHOSEN FOR STOCKPILING OPERATIONS SHALL BE DRY AND STABLE.
2. MAXIMUM SLOPE OF STOCKPILE SHALL BE 2H:1V.
3. UPON COMPLETION OF SOIL STOCKPILING, EACH PILE SHALL BE SURROUNDED WITH EITHER SILT FENCING OR STRAW BALES, THEN STABILIZED WITH VEGETATION OR COVERED.

**ISSUED FOR REVIEW
NOT FOR CONSTRUCTION
05/29/18**

REV.	DESCRIPTION	DATE	BY	CK	APP	OWNER ENGINEER:	APPROVAL STAMP:	PE Stamp:	IUSA ENGINEERING CONFIDENTIAL, PROPRIETARY and TRADE SECRET INFORMATION Property of Iberdrola, USA	CMP IBERDROLA - USA	SITE DETAILS
B	MEDEP PERMIT SET COMMENT REVISIONS	05/29/18	EVD	KRV							SH 5 OF 6
						DRAWING PREPARED BY:	ACCEPTED BY OE:				MERRILL ROAD/1076 LEWISTON, ME
											SCALE: NONE FILE: 1076-003-005SH006.DWG
											1076-003-005
											REV. B

ANSI D15.1 CADD Drawing. DO NOT REVISE MANUALLY.

CONSTRUCTION SEQUENCE:

- THE SITE CONTRACTOR SHALL DEVELOP A SITE-SPECIFIC CONSTRUCTION SEQUENCE PLAN, TO BE SUBMITTED TO THE MAINE DEPARTMENT OF ENVIRONMENTAL PROTECTION PRIOR TO CONSTRUCTION. AT A MINIMUM, THE PLAN MUST INCLUDE THE FOLLOWING ELEMENTS.
- ESTABLISH CONSTRUCTION WORKSPACE LIMITS; IDENTIFY AND MARK SENSITIVE RESOURCES.
 - PERFORM ALL WORK IN ACCORDANCE WITH MAINE EROSION AND SEDIMENT CONTROL PRACTICES FIELD GUIDE FOR CONTRACTORS (2015).
 - PRIOR TO USAGE, CONSTRUCT AND STABILIZE THE CONSTRUCTION ENTRANCE ON THE EXISTING PERMANENT ACCESS ROAD WITH A STONE PAD, MUD RACK, OR OTHER MATERIALS USED TO REDUCE THE TRACKING OR FLOWING OF SEDIMENT OFF THE SITE AND MAINTAIN UNTIL PAVING IS COMPLETED.
 - CLEAR TIMBER AND BRUSH; DO NOT GRUB UNTIL JUST PRIOR TO PRELIMINARY GRADING AND ESTABLISHMENT AND STABILIZATION OF TEMPORARY OR PERMANENT DRAINAGE COURSES.
 - INSTALL AND MAINTAIN SEDIMENT BARRIERS SUCH AS SILT FENCING AND/OR OTHER EROSION CONTROL BARRIERS ALONG THE DOWNHILL LIMIT OF WORK, AS SHOWN ON THE DRAWINGS. SEDIMENT BARRIER LOCATIONS MAY BE ADJUSTED IN THE FIELD BASED ON SITE CONDITIONS AS DETERMINED BY THE ENGINEERING INSPECTOR. WHERE SILT FENCE CANNOT BE TOED-IN PROPERLY DUE TO TREE ROOTS, ROCKS OR FROZEN GROUND, HAY BALES OR AN EROSION CONTROL MIX BERM MAY BE SUBSTITUTED. SILT FENCING WILL BE INSTALLED AFTER CLEARING BUT PRIOR TO GRUBBING AND GRADING ACTIVITIES. ANY EROSION ISSUES DEVELOPED DURING CLEARING WILL BE TEMPORARILY STABILIZED AS NECESSARY.
 - INSTALL THE SEDIMENT BASIN CONTROL STRUCTURE AND OUTLET PIPING AND GRADE THE SEDIMENT BASIN AND SURROUNDING AREA TO PROPOSED PLAN GRADES UP TO ELEVATION 312' SUCH THAT RUNOFF FROM UPSTREAM DISTURBANCES MAY FLOW INTO THE BASIN.
 - STABILIZE PERMANENT ACCESS ROAD SURFACE, PARKING AREAS AND EQUIPMENT STORAGE AND LAYDOWN AREAS WITH MATTING, CRUSHED STONE OR GRAVEL SUBBASE AS NECESSARY TO MINIMIZE RUTTING AND AVOID PONDING.
 - CONCURRENT WITH INITIATION OF SITE GRADING, CONSTRUCT AND STABILIZE TEMPORARY DRAINAGE SWALES, DIVERSION BERMS, CHECK DAMS, AND CULVERTS WITH TEMPORARY INLET AND OUTLET STRUCTURES TO MINIMIZE SEDIMENT IN SITE RUNOFF DURING THE CONSTRUCTION OF THE ROADWAY. DEWATER IN ACCORDANCE WITH DEWATERING NOTES ON DRAWING 1076-003-005 SHEET 5 OF 6.
 - INSTALL PROPERLY SPACED STONE CHECK DAMS IN ANY SECTION OF DITCH WITHIN 24 HOURS OF FORMING, SHAPING OR ROUGH GRADING THAT SECTION OF DITCH.
 - MINIMIZE THE AMOUNT OF DISTURBANCE AT ANY ONE TIME BY STAGING CONSTRUCTION AS MUCH AS PRACTICAL FOR EFFICIENT CONSTRUCTION OF THE FACILITY. NATURAL VEGETATIVE BUFFERS OR STRIPS SHOULD BE LEFT IN PLACE WHERE FEASIBLE TO AID IN SEDIMENT RETENTION AND REDUCE EROSION POTENTIAL.
 - STABILIZE ANY NEWLY GRADED SLOPE GREATER THAN EIGHT PERCENT AND ANY SECTION OF NEWLY CONSTRUCTED DITCH USING ANCHORED EROSION CONTROL BLANKETS OR OTHER APPROVED MULCHING TECHNIQUES WITHIN 24 HOURS. STABILIZE ANY SLOPE EXCEEDING EIGHT PERCENT AND BROUGHT TO FINAL GRADE WITHIN 24 HOURS USING ANCHORED EROSION CONTROL BLANKETS OR EROSION CONTROL MIX APPLIED IN ACCORDANCE WITH MAINE EROSION AND SEDIMENT PRACTICES FIELD GUIDE FOR CONTRACTORS (2015). STABILIZE ANY SECTION OF DITCH BROUGHT TO FINAL GRADE WITHIN 24 HOURS USING THE APPROVED PERMANENT STABILIZATION MEASURES FOR DITCHES.
 - DUST CONTROL METHODS WILL BE EMPLOYED AFTER GRADING AND PRIOR TO FINAL STABILIZATION TO PREVENT THE BLOWING AND MOVEMENT OF DUST THROUGH THE APPLICATION OF WATER AND/OR CALCIUM CHLORIDE TO REDUCE WIND EROSION. REPETITIVE TREATMENT WILL BE APPLIED AS NEEDED TO ACCOMPLISH CONTROL.
 - APPLY TEMPORARY SEED AND MULCH TO ANY EXPOSED AREAS WHERE ACTIVITY IS NOT ANTICIPATED FOR 30 DAYS OR MORE, OR WHERE ACTIVITY HAS NOT OCCURRED WITHIN 30 DAYS. TEMPORARILY MULCH ANY EXPOSED AREAS WHERE ACTIVITY IS NOT ANTICIPATED OR HAS NOT OCCURRED IN 7 DAYS.
 - REMOVE EXCESS SPOILS FROM SITE THAT WILL NOT BE USED FOR THE FINAL DESIGN AND STABILIZATION. STOCKPILED SOILS THAT REMAIN IN PLACE FOR 48 HOURS OR MORE WILL BE CONTAINED WITH SEDIMENT BARRIERS SUCH AS SILT FENCE, HAY BALES OR EQUIVALENT. THE SEDIMENT BARRIERS SHALL BE ADEQUATELY LOCATED AND REINFORCED TO HANDLE A SIGNIFICANT RAIN EVENT AND THE POTENTIAL SLUMPING OF THE PILE. BETWEEN MAY 1 AND OCTOBER 15, APPLY TEMPORARY SEED AND MULCH TO A STOCKPILE THAT IS NOT EXPECTED TO BE DISTURBED WITHIN 30 DAYS. APPLY ANCHORED MULCH DAILY, AS NEEDED, DURING WINTER CONSTRUCTION.
 - INSPECT AND REPAIR EROSION CONTROL MEASURES DAILY IN AREAS OF ACTIVE CONSTRUCTION; OTHERWISE WEEKLY AND AFTER RAINFALL OF 1/2" OR GREATER WITHIN A 24-HOUR PERIOD. REMOVE ACCUMULATED SEDIMENT WHEN IT REACHES 1/3 THE HEIGHT OF THE BARRIER.
 - MONITOR PUBLIC ROADS FOR SIGNS OF TRACKING OR SPILLING OF SPOIL MATERIAL AND CLEAN UP AS NEEDED.
 - COMPLETE FINAL GRADING AND STABILIZATION OF EARTHEN STRUCTURES SUCH AS DIVERSION BERMS, DITCH TURNOUTS AND SWALES THAT WILL CONTROL RUNOFF. LOWER THE TEMPORARY SEDIMENT BASIN INLET GRATE TOP TO THE FINAL PROPOSED PLAN ELEVATION.
 - FINISH GRADE AND REPLACE TOPSOIL OR LOAM IN DISTURBED AREAS. SEED AND MULCH DISTURBED AREAS WITHIN 6 DAYS OF FINAL GRADING.
 - MAINTAIN ALL TEMPORARY EROSION CONTROLS AND SEDIMENT BARRIERS UNTIL VEGETATION HAS BEEN ESTABLISHED OVER 85-90% OF THE AREA TO BE RE-VEGETATED. RESEED SPARSELY VEGETATED AREAS.
 - REMOVE ALL TEMPORARY EROSION AND SEDIMENTATION CONTROL MEASURES ONCE THE SITE IS PERMANENTLY STABILIZED.

MULCH AND SEEDING SPECIFICATIONS

SUMMARY OF TEMPORARY AND PERMANENT MULCH APPLICATION REQUIREMENTS			
CONDITION	TIMING	MULCH TYPE ^{1,2}	APPLICATION RATES
TEMPORARY			
	IF NO ACTIVITY IN EXPOSED AREAS FOR 7 DAYS, OR PRIOR TO A STORM EVENT	STRAW MULCH OR WOOD FIBER MULCH	2 TONS/ACRES 2000 LB./ACRES
ALL DISTRIBUTED AREAS OF THE CONSTRUCTION WORKSPACE	APPLY MULCH TO ALL EXPOSED AREAS IF NO ACTIVITY OCCURS WITHIN 30 DAYS. APPLY MULCH AND TEMPORARY SEEDING SOONER WHEN IT CAN BE ANTICIPATED THAT ACTIVITY IS NOT GOING TO OCCUR WITHIN 30 DAYS.	STRAW MULCH OR WOOD FIBER MULCH	2 TONS/ACRES 2000 LB./ACRES ³
ALL WORK AREAS EXPOSED ARE TO BE MULCHED DAILY EACH TIME SOIL IS DISTURBED	OCTOBER 15 - MAY 1	STRAW MULCH OR WOOD FIBER MULCH	3 TONS/ACRES 2000 LB./ACRES
PERMANENT			
ON ALL EXPOSED AREAS AFTER SEEDING TO STABILIZE THE SOIL SURFACE	PERMANENT GRASS AND/OR LEGUME SEEDING COVERED BY HAY OR STRAW MULCH ON ALL AREAS THAT HAVE BEEN RESTORED TO FINAL GRADE. THIS DOES NOT APPLY TO AREAS STABILIZED BY OTHER MEANS SUCH AS JUTE MATTING OR PERMANENT EROSION CONTROL MIX.	CRIMPED STRAW MULCH OR PAPER MULCH OR WOOD FIBER MULCH	2 TONS/ACRES 1500 LB./ACRES ⁴ 2000 LB./ACRES
WOOD CHIP APPLICATION AREAS	PERMANENT GRASS AND/OR LEGUME SEEDING COVERED BY HAY OR STRAW MULCH ON ALL AREAS THAT HAVE BEEN RESTORED TO FINAL GRADE. THIS DOES NOT APPLY TO AREAS STABILIZED BY OTHER MEANS SUCH AS JUTE MATTING OR PERMANENT EROSION CONTROL MIX.	CRIMPED STRAW MULCH OR PAPER MULCH OR WOOD FIBER MULCH	2 TONS/ACRES 1500 LB./ACRES ⁴ 2000 LB./ACRES
NOTES: 1. STRAW AND HAY MULCH MAY BE USED INTERCHANGEABLY, EXCEPT IN WETLAND AREAS WHERE STRAW MULCH WILL BE REQUIRED. 2. DOUBLE RATE OF WOOD FIBER MULCH WHEN USED IN CRITICAL AREAS. 3. STRAW, HAY, OR HYDROMULCH (WOOD FIBER OR PAPER MULCH AS APPROPRIATE) WILL PROVIDE 90 PERCENT GROUND COVERAGE 4. PAPER MULCH IS ACCEPTABLE FOR USE DURING THE GROWING SEASON. ON SLOPES GREATER THAN 30 PERCENT AND IN AREAS WHERE VEGETATION HAS NOT ESTABLISHED WELL, ADDITIONAL HAY MULCH WILL BE ADDED AS A WINTERIZING MEASURE.			

SEED MIX SPECIFICATIONS		
SEED MIX NAME	SEED MIX COMPONENTS	LB./ACRE ¹
TEMPORARY SEED MIX	ANNUAL RYEGRASS	40
PERMANENT UPLAND SEED MIX	REDFEED	4
	CREeping RED FESCUE	40
	TALL FESCUE	40
	BIRDSFOOT TREFOLI	16
WOOD CHIP APPLICATION SEED MIX	CREeping RED FESCUE	20
	REDFEED	4
	TALL FESCUE	30
	CROWN VETCH	30
WETLAND SEED MIX	ANNUAL RYEGRASS	40
SUPPLEMENTAL WINTER SEED MIX ²	WINTER RYEGRASS	120
NOTES: 1. INCREASE SEEDING RATES 10% WHEN HYDROSEEDING 2. WINTER RYE WILL BE ADDED TO PERMANENT UPLAND MIX AT A RATE OF 120 LB./ACRE BETWEEN OCTOBER 15 AND MAY 1		

FERTILIZER AND LIMESTONE REQUIREMENTS:

THE FERTILIZER AND LIME APPLICATION RATES SHALL BE DETERMINED USING THE SITE-SPECIFIC SOIL TEST RESULTS.

MULCH ANCHORING REQUIREMENTS

ON SLOPES GREATER THAN 3 PER CENT, HAY OR STRAW MULCH WILL BE FIRMLY ANCHORED INTO THE SOIL UTILIZING ONE OF THE FOLLOWING METHODS:
 -CRIMPING WITH A STRAIGHT OR NOTCHED MULCH CRIMPING TOOL (FARM DISCS WILL NOT BE ALLOWED);
 -TRACK WALKING WITH DEEP-CLEATED EQUIPMENT OPERATING UP AND DOWN THE SLOPE (MULCH CRIMPED PERPENDICULAR TO THE SLOPE) ON SLOPES LESS THAN 25 PERCENT;
 -APPLICATION OF MULCH NETTING;
 -APPLICATION OF 500 LB./ACRE OF WOOD FIBER MULCH OVER STRAW/HAY MULCH; AND
 -COMMERCIALY AVAILABLE TACKIFIERS (EXCEPT WITHIN 100 FEET OF WATERBODIES OR WETLANDS).

SUMMARY OF SEEDING REQUIREMENTS		
CONDITION	TIMING ^{1,2}	SEED MIX
TEMPORARY SEEDING ³	TEMPORARY SEED BETWEEN MAY 1 AND OCTOBER 15 ONLY. DISTURBED AREAS OR SPOIL STOCKPILES WILL BE SEEDED IMMEDIATELY IF FURTHER DISTURBANCE IS NOT EXPECTED FOR 30 DAYS OR MORE.	ANNUAL RYEGRASS
PERMANENT SEEDING ^{3,4}		
UPLAND PORTIONS OF THE CONSTRUCTION AREA	DISTURBED AREA WILL BE SEEDED WITHIN 6 DAYS OF FINAL GRADING.	PERMANENT UPLAND MIX
SLOPES GREATER THAN 3:1	DISTURBED AREA WILL BE SEEDED IMMEDIATELY AFTER SEEDBED PREPARATION.	PERMANENT UPLAND MIX
WETLANDS	DISTURBED WETLANDS WILL BE SEEDED WITHIN 6 DAYS OF FINAL GRADING.	ANNUAL RYEGRASS
WOOD CHIP APPLICATION AREAS	DISTURBED AREA WILL BE SEEDED WITHIN 6 DAYS OF FINAL GRADING.	WOODCHIP APPLICATION SEED MIX
WINTER DORMANT SEEDING	DORMANT SEED BETWEEN OCTOBER 15 AND MAY 1 ONLY. NO SEEDING WILL OCCUR IF SNOW DEPTHS EXCEED 1 INCH.	PERMANENT UPLAND MIX PLUS WINTER RYEGRASS
NOTES: 1. WEATHER CONDITIONS PERMITTING. 2. AREAS THAT DO NOT SUCCESSFULLY REVEGETATE WITHIN APPROPRIATE PERIOD OF TIME WILL BE RESEED AS NECESSARY. 3. LOOSEN COMPACTED SOIL TO A MINIMUM DEPTH OF 4 INCHES. 4. TOP DRESS WITH 6 INCHES LOAM, AS NEEDED.		

**ISSUED FOR REVIEW
NOT FOR CONSTRUCTION
08/09/18**

REV.	DESCRIPTION	DATE	BY	CK	APP
B	MDEP PERMIT SET COMMENT REVISIONS	05/29/18	EVD	KRV	
B	MDEP PERMIT SET COMMENT REVISIONS	08/09/18	RST	KRV	

OWNER ENGINEER:	APPROVAL STAMP:
DRAWING PREPARED BY:	ACCEPTED BY OE:

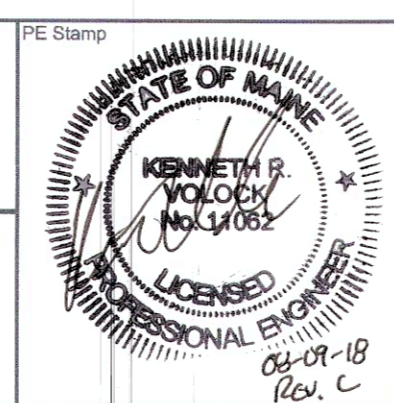

IUSA ENGINEERING CONFIDENTIAL, PROPRIETARY and TRADE SECRET INFORMATION Property of Iberdrola, USA			
REV.	DATE	BY	DESCRIPTION
APP.	DATE:		

SITE DETAILS	
SH 6 OF 6	
MERRILL ROAD/1076	LEWISTON, ME
DR. EVD	SCALE: NONE
CK. KRV	FILE: 1076-003-005SH006.DWG
APP.	NO.
DATE:	1076-003-005
	C