

Vendor Contact Information

MIKE MENNER
607-733-5506 ext.
mmenner@chemungsupply.com

Commodity Information

Vendor Line #: 1

Vendor Name: CHEMUNG SUPPLY CORP

Commodity Line #: 1

Commodity Code: 76006

Commodity Description: Sabre Plow Blades/Cutting Edges

Commodity Specifications: As per the specifications attached made part of this MA. Free freight on orders \$10K+, \$130.00 per pallet if under \$10K.

Commodity Extended Description: Replaces MA 180524-138. See attached "Built Blades Sabre Quote"-please verify pricing invoiced! Also see "ADD" items on "Added Items-Vermont Contract" document as well.

Quantity	UOM	Unit Price
0.00000		0.000000
Delivery Days	Free On Board	
Contract Amount	Service Start Date	Service End Date
0.00	11/23/20	06/30/22
Catalog Name	Discount	
	0.0000 %	
	Discount Start Date	Discount End Date

Please see authorized signatures displayed on the next page

Each signatory below represents that the person has the requisite authority to enter into this Contract.
The parties sign and cause this Contract to be executed.

State of Maine - Department of Administrative and Financial Services

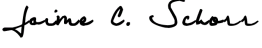
DocuSigned by:

6D6437754DD0459... 12/10/2021

Signature Date

Jaime C. Schorr, Chief Procurement Officer

and

CHEMUNG SUPPLY CORP

DocuSigned by:

5160C70D44BE4B1 12/10/2021

Signature Date

Marc Stemerman, President

RIDERS

<input checked="" type="checkbox"/>	The following riders are hereby incorporated into this Contract and made part of it by reference: (check all that apply)
<input checked="" type="checkbox"/>	Rider A – Scope of Work and/or Specifications
<input checked="" type="checkbox"/>	Rider B – Terms and Conditions
<input type="checkbox"/>	Rider C - Exceptions
<input checked="" type="checkbox"/>	Bid Cover Page and Debarment Form – Appendix A from RFQ
<input type="checkbox"/>	Municipality Political Subdivision and School District Participation Certification – Appendix D from RFQ
<input checked="" type="checkbox"/>	Price sheet
<input type="checkbox"/>	Other – Included at Department's Discretion

RIDER A
Scope of Work and/or Specifications
MA 211210-047

Commodity: Sabre Snow Plow Blades/Cutting Edges

Master Agreement Competitive Bid RFQ: NOI 0720200623

Change in Vendor: Built Blades LLC was purchased by Chemung Supply Corp in November of 2020, this is a replacement for MA 180524-138

Contract Period: Through June 30, 2022.

Vendor Contact Person: The vendor contact person will help consumers place orders, inquire about orders that have not been delivered, all shipping issues, quality issues and any issues pertaining to the Master Agreement (MA) contract. All orders not submitted through a Delivery Order will be sent through the vendor contact person. The vendor contact person for this MA is:
Name: Matt Aquino **Tel:** 585-613-6821 **Email:** info@builtblades.com

Prices: For orders over \$10,000 prices are with shipping terms of “Free on Board (FOB) – Destination”. The FOB Destination also intends for this to mean that all goods shall be priced to include shipping charges, if any, to the State’s desired location. For order less than \$10,000 there will be a \$130.00 per pallet freight charge. The State shall not bear any responsibility for the goods in question until the State takes possession of them at the destination point of delivery.

Quantities: It is understood and agreed that the MA will cover the actual quantities required by the State over the length of the contract.

Ordering Procedures: Delivery Orders (DO) will be created in AdvantageME for all orders over \$5000.00. If a DO is used, the DO will be emailed to the email address referenced on the MA as a .pdf file. Orders less than \$5000.00 can be placed using a State of Maine issued P-Card (credit card).

Delivery: The vendor is responsible for the delivery of material in first class condition at the point of delivery, and in accordance with good commercial practice.



2019 Optional Configurations

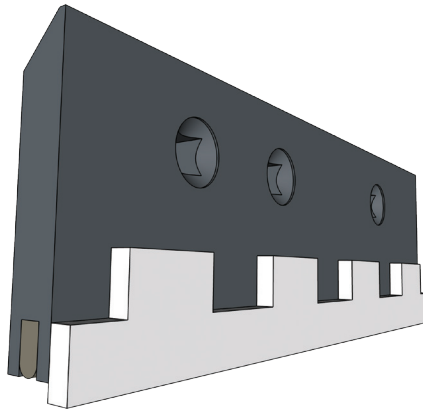
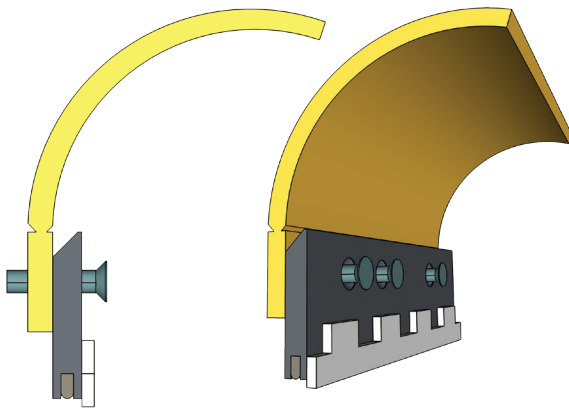
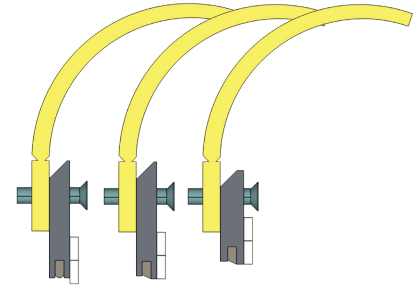
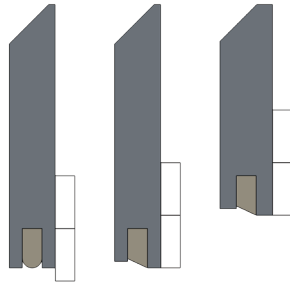

Version 1

Frame Size : 7/8"W x 5"T
Carbide Insert : 3/4"T Bull-Nose
Sabre Plate Weld : 1/4" Overhang

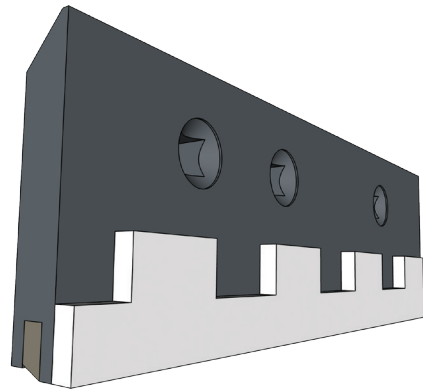
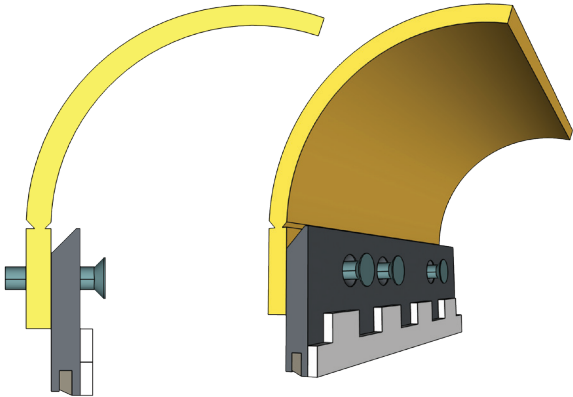

Version 2

Frame Size : 7/8"W x 5"T
Carbide Insert : 3/4"T 40° Trap.
Sabre Plate Weld : Flush to Base

Reason for Changes
- Improved Cutting Performance

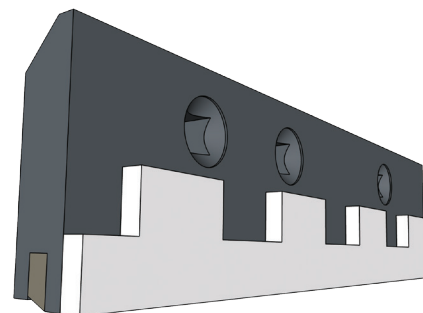
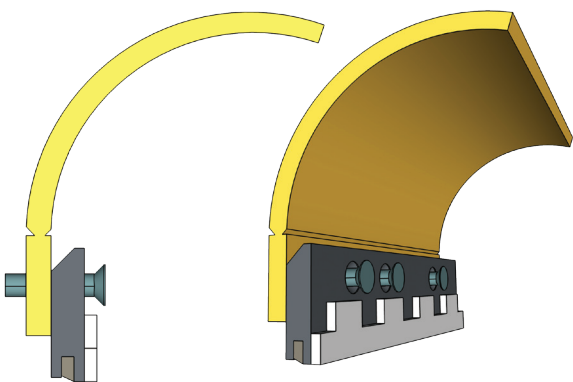

Version 3

Frame Size : 1"W x 4"T
Carbide Insert : 3/4"T 40° Trap.
Sabre Plate Weld : Flush to Base

Reason for Changes
- Improved Cutting Performance
- Improved Underbody Clearance
- Improved Downpressure Capacity





ARMORED CARBIDE SNOWPLOW BLADE

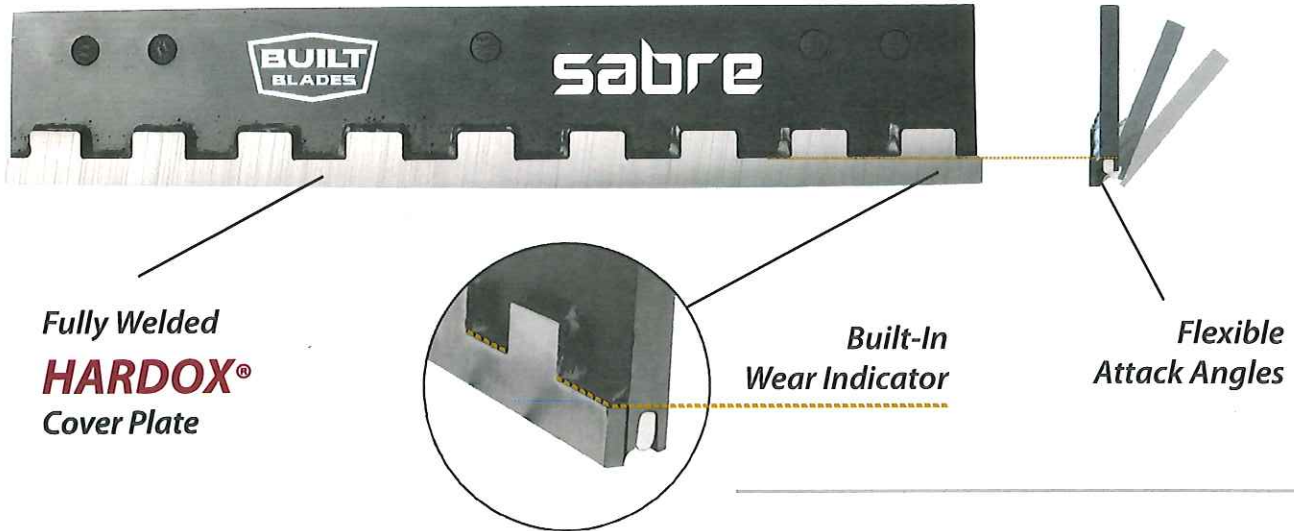

Fully Welded
HARDOX®
Cover Plate

Built-In
Wear Indicator

Flexible
Attack Angles

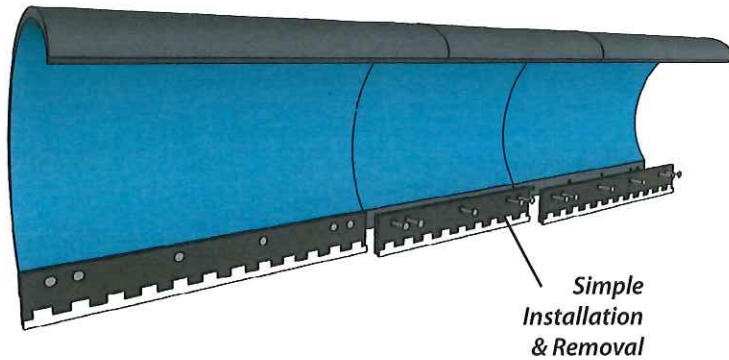





Simple
Installation
& Removal

The **sabre** Armored Carbide Snowplow Blade features a unique fully-welded **HARDOX®** cover plate that provides superior carbide protection and eliminates the need for full-length cover blades.

The light-weight sectional blades improve safety, and require less man power to install. They are also easier for storage and handling.

The Sabre's cover plate also features a built-in **Wear Indicator** that helps safely demonstrate remaining blade life.

COMPARISON CHART

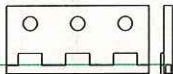
sabre	vs.	Carbide & Cover Blade
 <p>11ft. Blade = 190 lbs. 52 lbs. : 3ft. Sabre + 69 lbs. : 4ft. Sabre (x2)</p> <p>-40% Lighter</p>	<p>WEIGHT</p>	 <p>11ft. Blade = 319 lbs. 176 lbs. : Carbide Blades (x3) + 140 lbs. : Cover Blade</p>
<p>HARDOX Abrasion-Resistant Steel - 2x Abrasion Resistance - 3x Impact Resistance</p> 	<p>COVER PLATE</p>	<p>1084 High Carbon Steel (Requires 2-3 Workers to Install)</p> 
<p>BUILT-IN</p> 	<p>WEAR INDICATOR</p>	<p>N/A</p>



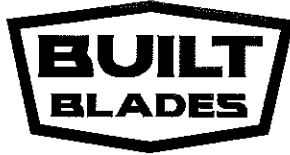

sabre V

ARMORED CARBIDE V-BLADE KIT

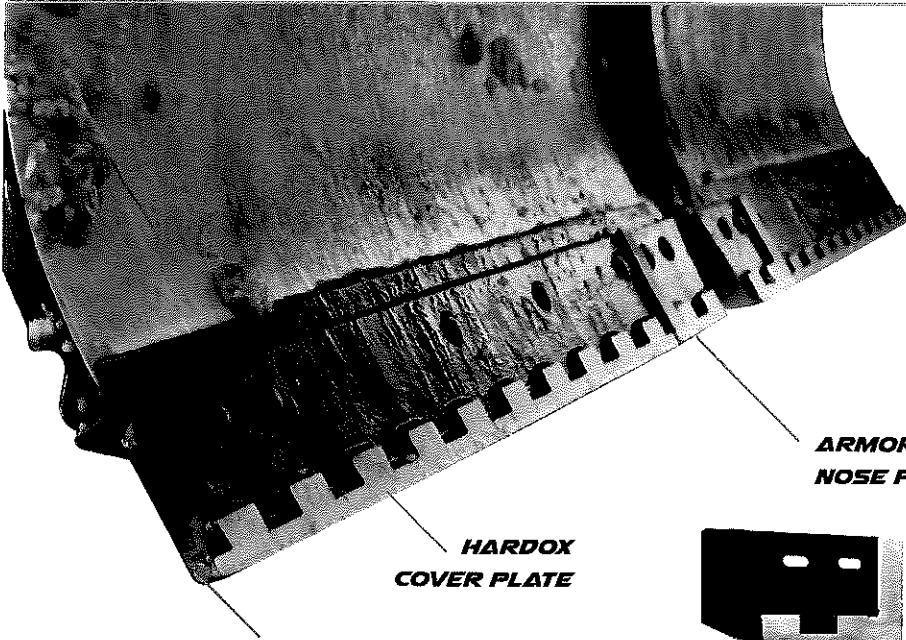

Built Blades' **sabre V** Armored Carbide V-Blade Kits are designed for easy bolt-on replacement and built to handle the most extreme plowing conditions.

Heavy-duty tungsten carbide inserts provide extended wear life up to 10:1 over OEM steel and are protected against abrasion and impacts by Built Blades' patent-pending built-in light weight armored cover plate.

Long lasting wear materials inserted at the base keep the edge running at the optimal operating height, helping it perform at its' best for the life of the blade.

**HARDOX
COVER PLATE**

TUNGSTEN CARBIDE

**ARMORED
NOSE PIECES**

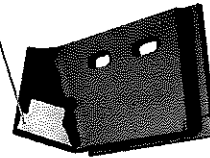

(back side)

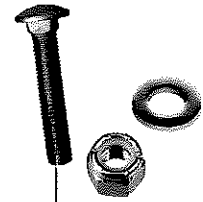

**GRADE 8
HARDWARE**

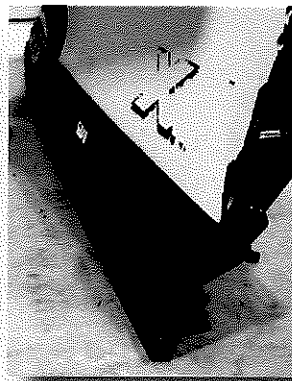
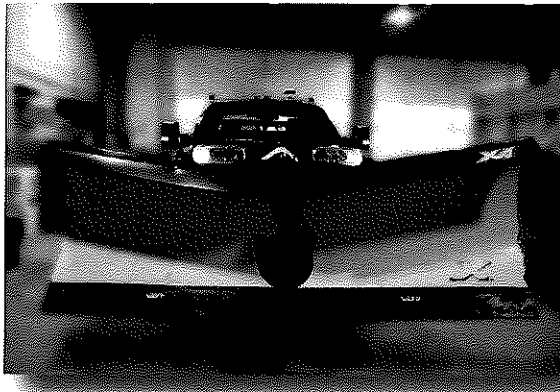

Kits Include :

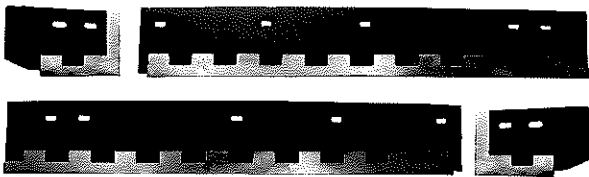

sabre V BLADE KITS

PART #	DESCRIPTION
SVB-86	8'6" SABRE V BLADE KIT
SVB-96	9'6" SABRE V BLADE KIT



Kits Designed to Fit :



8'6" & 9'6"
WESTERN MVP PLUS STYLE



8'6" & 9'6"
FISHER XV STYLE

Built Blades' **sabre V** Kits contain everything needed for a complete replacement, including : (2) armored carbide blades, (2) armored center nose pieces, and necessary grade-8 mounting hardware.

RIDER B
TERMS AND CONDITIONS

- 1. DEFINITIONS:** The following definitions are applicable to these standard terms and conditions:
 - a. The term “Buyer” or “State” shall refer to the Government of the State of Maine or a person representing the Government of the State of Maine.
 - b. The term “Department” or “DAFS” shall refer to the State of Maine Department of Administrative and Financial Services.
 - c. The term “Bureau” or “BGS” shall refer to the State of Maine Bureau of General Services.
 - d. The term “Division” shall refer to the State of Maine Division of Purchases.
 - e. The term “Contractor”, “Vendor”, or “Provider” shall refer to the organization that is providing goods and/or services through the contract to which these standard terms and conditions have been attached and incorporated.
 - f. The term “Contract” or “Agreement” shall refer to the contract document to which these standard terms and conditions apply, taking the format of a Buyer Purchase Order (BPO) or Master Agreement (MA) or other contractual document that is mutually agreed upon between the State and the Contractor.

- 2. WARRANTY:** The Contractor warrants the following:
 - a. That all goods and services to be supplied by it under this Contract are fit and sufficient for the purpose intended, and
 - b. That all goods and services covered by this Contract will conform to the specifications, drawing samples, symbols or other description specified by the Division, and
 - c. That such articles are merchantable, good quality, and free from defects whether patent or latent in material and workmanship, and
 - d. That all workmanship, materials, and articles to be provided are of the best grade and quality, and
 - e. That it has good and clear title to all articles to be supplied by it and the same are free and clear from all liens, encumbrances and security interest.

Neither the final certificate of payment nor any provision herein, nor partial nor entire use of the articles provided shall constitute an acceptance of work not done in accordance with this agreement or relieve the Contractor liability in respect of any warranties or responsibility for faulty material or workmanship. The Contractor shall remedy any defects in the work and pay any damage to other work resulting therefrom, which shall appear within one year from the date of final acceptance of the work provided hereunder. The Division of Purchases shall give written notice of observed defects with reasonable promptness.

3. TAXES: Contractor agrees that, unless otherwise indicated in the order, the prices herein do not include federal, state, or local sales or use tax from which an exemption is available for purposes of this order. Contractor agrees to accept and use tax exemption certificates when supplied by the Division as applicable. In case it shall ever be determined that any tax included in the prices herein was not required to be paid by Contractor, Contractor agrees to notify the Division and to make prompt application for the refund thereof, to take all proper steps to procure the same and when received to pay the same to the Division.

4. PACKING AND SHIPMENT: Deliveries shall be made as specified without charge for boxing, carting, or storage, unless otherwise specified. Articles shall be suitably packed to secure lowest transportation cost and to conform to the requirements of common carriers and any

applicable specifications. Order numbers and symbols must be plainly marked on all invoices, packages, bills of lading, and shipping orders. Bill of lading should accompany each invoice. Count or weight shall be final and conclusive on shipments not accompanied by packing lists.

5. DELIVERY: Delivery should be strictly in accordance with delivery schedule. If Contractor's deliveries fail to meet such schedule, the Division, without limiting its other remedies, may direct expedited routing and the difference between the expedited routing and the order routing costs shall be paid by the Contractor. Articles fabricated beyond the Division's releases are at Contractor's risk. Contractor shall not make material commitments or production arrangements in excess of the amount or in advance of the time necessary to meet delivery schedule, and, unless otherwise specified herein, no deliveries shall be made in advance of the Division's delivery schedule. Neither party shall be liable for excess costs of deliveries or defaults due to the causes beyond its control and without its fault or negligence, provided, however, that when the Contractor has reason to believe that the deliveries will not be made as scheduled, written notice setting forth the cause of the anticipated delay will be given immediately to the Division. If the Contractor's delay or default is caused by the delay or default of a subcontractor, such delay or default shall be excusable only if it arose out of causes beyond the control of both Contractor and subcontractor and without fault of negligence or either of them and the articles or services to be furnished were not obtainable from other sources in sufficient time to permit Contractor to meet the required delivery schedule.

6. FORCE MAJEURE: The State may, at its discretion, excuse the performance of an obligation by a party under this Agreement in the event that performance of that obligation by that party is prevented by an act of God, act of war, riot, fire, explosion, flood or other catastrophe, sabotage, severe shortage of fuel, power or raw materials, change in law, court order, national defense requirement, or strike or labor dispute, provided that any such event and the delay caused thereby is beyond the control of, and could not reasonably be avoided by, that party. The State may, at its discretion, extend the time period for performance of the obligation excused under this section by the period of the excused delay together with a reasonable period to reinstate compliance with the terms of this Agreement.

7. INSPECTION: All articles and work will be subject to final inspection and approval after delivery, notwithstanding prior payment, it being expressly agreed that payment will not constitute final acceptance. The Division of Purchases, at its option, may either reject any article or work not in conformity with the requirements and terms of this order, or re-work the same at Contractor's expense. The Division may reject the entire shipment where it consists of a quantity of similar articles and sample inspection discloses that ten (10%) percent of the articles inspected are defective, unless Contractor agrees to reimburse the Division for the cost of a complete inspection of the articles included in such shipment. Rejected material may be returned at Contractor's risk and expense at the full invoice price plus applicable incoming transportation charges, if any. No replacement of defective articles of work shall be made unless specified by the Division.

8. INVOICE: The original and duplicate invoices covering each and every shipment made against this order showing Contract number, Vendor number, and other essential particulars, must be forwarded promptly to the ordering agency concerned by the Vendor to whom the order is issued. Delays in receiving invoice and also errors and omissions on statements will be considered just cause for withholding settlement without losing discount privileges. All accounts are to be carried in the name of the agency or institution receiving the goods, and not in the name of the Division of Purchases.

9. ALTERATIONS: The Division reserves the right to increase or decrease all or any portion of the work and the articles required by the bidding documents or this agreement, or to eliminate all or any portion of such work or articles or to change delivery date hereon without invalidating this Agreement. All such alterations shall be in writing. If any such alterations are made, the contract amount or amounts shall be adjusted accordingly. In no event shall Contractor fail or refuse to continue the performance of the work in providing of articles under this Agreement because of the inability of the parties to agree on an adjustment or adjustments.

10. TERMINATION: The Division may terminate the whole or any part of this Agreement in any one of the following circumstances:

- a. The Contractor fails to make delivery of articles, or to perform services within the time or times specified herein, or
- b. If Contractor fails to deliver specified materials or services, or
- c. If Contractor fails to perform any of the provisions of this Agreement, or
- d. If Contractor so fails to make progress as to endanger the performance of this Agreement in accordance with its terms, or
- e. If Contractor is adjudged bankrupt, or if it makes a general assignment for the benefit of its creditors or if a receiver is appointed because of its insolvency, or
- f. Whenever for any reason the State shall determine that such termination is in the best interest of the State to do so.

In the event that the Division terminates this Agreement in whole or in part, pursuant to this paragraph with the exception of 8(f), the Division may procure (articles and services similar to those so terminated) upon such terms and in such manner as the Division deems appropriate, and Contractor shall be liable to the Division for any excess cost of such similar articles or services.

11. NON-APPROPRIATION: Notwithstanding any other provision of this Agreement, if the State does not receive sufficient funds to fund this Agreement and other obligations of the State, if funds are de-appropriated, or if the State does not receive legal authority to expend funds from the Maine State Legislature or Maine courts, then the State is not obligated to make payment under this Agreement.

12. COMPLIANCE WITH APPLICABLE LAWS: Contractor agrees that, in the performance hereof, it will comply with applicable laws, including, but not limited to statutes, rules, regulations or orders of the United States Government or of any state or political subdivision(s) thereof, and the same shall be deemed incorporated herein by reference. Awarding agency requirements and regulations pertaining to copyrights and rights in data. Access by the grantee, the subgrantee, the Federal grantor agency, the Comptroller General of the United States, or any of their duly authorized representatives to any books, documents, papers and records of the Contractor which are directly pertinent to that specific contract for the purpose of making audit, examination, excerpts, and transcriptions. Retention of all required records for three years after grantees or subgrantees make final payments and all other pending matters are closed. Compliance with all applicable standards, orders, or requirements issued under section 306 of the Clean Air Act (42 U.S.C. 1857(h), section 508 of the Clean Water Act, (33 U.S.C. 1368), Executive Order 11738, and Environmental Protection Agency regulations (40 CFR part 15). (Contracts, subcontracts, and subgrants of amounts in excess of \$100,000). Mandatory standards and policies relating to energy efficiency which are contained in the state energy conservation plan issued in compliance with Energy Policy and Conservation Act (Pub. L. 94-163, 89 Stat. 871).

13. INTERPRETATION: This Agreement shall be governed by the laws of the State of Maine as to interpretation and performance.

14. DISPUTES: The Division will decide any and all questions which may arise as to the quality and acceptability of articles provided and installation of such articles, and as to the manner of performance and rate of progress under this Contract. The Division will decide all questions, which may arise as to the interpretation of the terms of this Agreement and the fulfillment of this Agreement on the part of the Contractor.

15. ASSIGNMENT: None of the sums due or to become due nor any of the work to be performed under this order shall be assigned nor shall Contractor subcontract for completed or substantially completed articles called for by this order without the Division's prior written consent. No subcontract or transfer of agreement shall in any case release the Contractor of its obligations and liabilities under this Agreement.

16. STATE HELD HARMLESS: The Contractor agrees to indemnify, defend, and save harmless the State, its officers, agents, and employees from any and all claims and losses accruing or resulting to any and all contractors, subcontractors, material men, laborers and other persons, firm or corporation furnishing or supplying work, services, articles, or supplies in connection with the performance of this Agreement, and from any and all claims and losses accruing or resulting to any person, firm or corporation who may be injured or damaged by the Contractor in the performance of this Agreement.

17. SOLICITATION: The Contractor warrants that it has not employed or written any company or person, other than a bona fide employee working solely for the Contractor to solicit or secure this Agreement, and it has not paid, or agreed to pay any company, or person, other than a bona fide employee working solely for the Contractor any fee, commission, percentage, brokerage fee, gifts, or any other consideration, contingent upon, or resulting from the award for making this Agreement. For breach or violation of this warranty, the Division shall have the absolute right to annul this agreement or, in its discretion, to deduct from the Agreement price or consideration, or otherwise recover the full amount of such fee, commission, percentage, brokerage fee, gifts, or contingent fee.

18. WAIVER: The failure of the Division to insist, in any one or more instances, upon the performance of any of the terms, covenants, or conditions of this order or to exercise any right hereunder, shall not be construed as a waiver or relinquishment of the future performance of any such term, covenant, or condition or the future exercise of such right, but the obligation of Contractor with respect to such future performance shall continue in full force and effect.

19. MATERIAL SAFETY: All manufacturers, importers, suppliers, or distributors of hazardous chemicals doing business in this State must provide a copy of the current Material Safety Data Sheet (MSDS) for any hazardous chemical to their direct purchasers of that chemical.

20. COMPETITION: By accepting this Contract, Contractor agrees that no collusion or other restraint of free competitive bidding, either directly or indirectly, has occurred in connection with this award by the Division of Purchases.

21. INTEGRATION: All terms of this Contract are to be interpreted in such a way as to be consistent at all times with this Standard Terms and Conditions document, and this document shall take precedence over any other terms, conditions, or provisions incorporated into the Contract.

**STATE OF MAINE
DEPARTMENT OF ADMINISTRATIVE AND FINANCIAL SERVICES
DIVISION OF PROCUREMENT SERVICES**

BID COVER PAGE

Bidder's Organization Name:		
Chief Executive - Name/Title:		
Tel:	Fax:	E-mail:
Headquarters Street Address:		
Headquarters City/State/Zip:		
<i>(provide information requested below if different from above)</i>		
Lead Point of Contact for Bid - Name/Title:		
Tel:	Fax:	E-mail:
Street Address:		
City/State/Zip:		

By signing below Bidder affirms:

- Their bid complies with all requirements of this RFQ;
- This bid and the pricing structure contained herein will remain firm for a period of 180 days from the date and time of the bid opening;
- That no personnel currently employed by the Department or any other State agency participated, either directly or indirectly, in any activities relating to the preparation of the Bidder's proposal;
- That no attempt has been made or will be made by the Bidder to induce any other person or firm to submit or not to submit a proposal; and
- The undersigned is authorized to enter into contractual obligations on behalf of the above-named organization.

Name:	Title:
Authorized Signature:	Date:

Debarment, Performance, and Non-Collusion Certification

By signing this document, I certify to the best of my knowledge and belief that the aforementioned organization, its principals, and any subcontractors named in this proposal:

- a. Are not presently debarred, suspended, proposed for debarment, and declared ineligible or voluntarily excluded from bidding or working on contracts issued by any governmental agency.*
 - b. Have not within three years of submitting the proposal for this contract been convicted of or had a civil judgment rendered against them for:*
 - i. fraud or a criminal offense in connection with obtaining, attempting to obtain, or performing a federal, state or local government transaction or contract.*
 - ii. violating Federal or State antitrust statutes or committing embezzlement, theft, forgery, bribery, falsification or destruction of records, making false statements, or receiving stolen property;*
 - iii. are not presently indicted for or otherwise criminally or civilly charged by a governmental entity (Federal, State or Local) with commission of any of the offenses enumerated in paragraph (b) of this certification; and*
 - iv. have not within a three (3) year period preceding this proposal had one or more federal, state or local government transactions terminated for cause or default.*
 - c. Have not entered into a prior understanding, agreement, or connection with any corporation, firm, or person submitting a response for the same materials, supplies, equipment, or services and this proposal is in all respects fair and without collusion or fraud. The above-mentioned entities understand and agree that collusive bidding is a violation of state and federal law and can result in fines, prison sentences, and civil damage awards.*
- Failure to provide this certification may result in the disqualification of the Bidder's proposal, at the discretion of the Department.**

To the best of my knowledge all information provided in the enclosed proposal, both programmatic and financial, is complete and accurate at the time of submission.

Name:	Title:
Authorized Signature:	Date:

2020 STATE OF MAINE PRICE LIST
BUILT BLADES, LLC.
Quick Guide

Description	State	
Sabre Steel	\$35.00	/ ft.
Sabre Standard	\$68.00	/ ft.
Sabre Heavy-Duty	\$85.00	/ ft.
Sabre Underbody	\$85.00	/ ft.
SVB-86	\$700.00	/ kit
SVB-96	\$775.00	/ kit
SVB-106	\$850.00	/ kit
Wear Shoes	\$161.50	/ each
Nose Pieces	\$100.00	/ each
Wear Plates	\$161.50	/ each
WP Curb Guard	\$275.00	/ each
HD Curb Guard	\$125.00	/ each
MD Curb Guard	\$90.00	/ each
G8 Nut	\$0.66	/ each
G8 Bolt	\$2.00	/ each
G8 Washer	\$0.40	/ each
36" Plow Marker Kit	\$36.00	/ kit

sabre STEEL PROTOTYPE PHASE

Part Number	Description	State
SAB-36-S	Sabre Armored Steel Blade / 36" / 3-3-12	\$105.00
SAB-48-S	Sabre Armored Steel Blade / 48" / 3-3-12	\$140.00

sabre STANDARD

Part Number	Description	State
SAB-36	Sabre Standard Blade / 36" / 3-3-12"	\$204.00
SAB-36-MR	Sabre Standard Blade / 36" / 3-3-12" / RH Mitre	\$204.00
SAB-36-ML	Sabre Standard Blade / 36" / 3-3-12" / LH Mitre	\$204.00
SAB-48	Sabre Standard Blade / 48" / 3-3-12"	\$272.00
SAB-48-MR	Sabre Standard Blade / 48" / 3-3-12" / RH Mitre	\$272.00
SAB-48-ML	Sabre Standard Blade / 48" / 3-3-12" / LH Mitre	\$272.00
SAB-44	Sabre Standard Blade / 44" / 3-3-12"	\$249.56
SAB-44-MR	Sabre Standard Blade / 44" / 2-4-4" / RH Mitre	\$249.56
SAB-44-ML	Sabre Standard Blade / 44" / 2-4-4" / LH Mitre	\$249.56

sabre HEAVY-DUTY

Part Number	Description	State
SAB-36-HD	Sabre Heavy-Duty Blade / 36" / 3-3-12"	\$255.00
SAB-36-HD-MR	Sabre Heavy-Duty Blade / 36" / 3-3-12" / RH Mitre	\$255.00
SAB-36-HD-ML	Sabre Heavy-Duty Blade / 36" / 3-3-12" / LH Mitre	\$255.00
SAB-48-HD	Sabre Heavy-Duty Blade / 48" / 3-3-12"	\$340.00
SAB-48-HD-MR	Sabre Heavy-Duty Blade / 48" / 3-3-12" / RH Mitre	\$340.00
SAB-48-HD-ML	Sabre Heavy-Duty Blade / 48" / 3-3-12" / LH Mitre	\$340.00
SAB-44-HD	Sabre Heavy-Duty Blade / 44" / 2-4-4"	\$311.95
SAB-44-HD-MR	Sabre Heavy-Duty Blade / 44" / 2-4-4" / RH Mitre	\$311.95
SAB-44-HD-ML	Sabre Heavy-Duty Blade / 44" / 2-4-4" / LH Mitre	\$311.95

sabre UNDERBODY

Part Number	Description	State
SAB-36-UB	Sabre Underbody / 36" / 3-3-6"	\$255.00
SAB-48-UB	Sabre Underbody / 48" / 3-3-6"	\$340.00

sabre VBLADE KITS

Part Number	Description	State
SVB-86	8'6" Sabre V-Blade Kit	\$700.00
SVB-96	9'6" Sabre V-Blade Kit	\$775.00
SVB-106	10'6" Sabre V-Blade Kit	\$850.00
SVB-NP-R	Sabre V-Blade Nose Piece / Right / Steel	\$100.00
SVB-NP-L	Sabre V-Blade Nose Piece / Left / Steel	\$100.00
SVB-NP-R-C	Sabre V-Blade Nose Piece / Right / Carbide	\$135.00
SVB-NP-L-C	Sabre V-Blade Nose Piece / Left / Carbide	\$135.00
SAB-106-W	Sabre V-Blade Wing Kit for 10'6" Conversion (Includes 2 pcs.)	\$68.00
SAB-WP-V	Sabre V-Blade Wear Plate	\$68.00

sabre WEAR PLATES

Part Number	Description	State
SAB-WP-24-H	Sabre Wear Plate / 24" / High Angle	\$161.50
SAB-WP-24-L	Sabre Wear Plate / 24" / Low Angle	\$161.50
SAB-WP-24-8-H	Sabre Wear Plate / 24" / High Angle / 8" Punch	\$161.50
SAB-WP-24-8-L	Sabre Wear Plate / 24" / Low Angle / 8" Punch	\$161.50
SAB-WP-H	Sabre Wear Plate / 18" / High Angle	\$130.00
SAB-WP-L	Sabre Wear Plate / 18" / Low Angle	\$130.00
SAB-WP-8-H	Sabre Wear Plate / 18" / High Angle / 8" Punch	\$130.00
SAB-WP-8-L	Sabre Wear Plate / 18" / Low Angle / 8" Punch	\$130.00
SAB-WP-BOSS	Sabre Wear Plate / 14" / Boss Punch	\$100.00

sabre WEAR PLATE CURB GUARDS

Part Number	Description	State
SAB-WPCG-H-L	Sabre Wear Plate Curb Guard / 24" / High Angle / Left	\$265.00
SAB-WPCG-H-R	Sabre Wear Plate Curb Guard / 24" / High Angle / Right	\$265.00
SAB-WPCG-L-L	Sabre Wear Plate Curb Guard / 24" / Low Angle / Left	\$265.00
SAB-WPCG-L-R	Sabre Wear Plate Curb Guard / 24" / Low Angle / Right	\$265.00

sabre NOSE PIECES

Part Number	Description	State
SAB-NP-880	Sabre Nose Piece / Everest	\$100.00
SAB-NP-840	Sabre Nose Piece / Tenco (Post 1984)	\$100.00
SAB-NP-810	Sabre Nose Piece / Frink / Henderson	\$100.00
SAB-NP-800	Sabre Nose Piece / Viking (Post 2000)	\$100.00

CURB GUARDS

Part Number	Description	State
CG-HD-R	Heavy-Duty Curb Guard / Right	\$130.00
CG-HD-L	Heavy-Duty Curb Guard / Left	\$130.00
CG-HD-R-8	Heavy-Duty Curb Guard / Right / 8" Punch	\$130.00
CG-HD-L-8	Heavy-Duty Curb Guard / Left / 8" Punch	\$130.00
CG-MD	Medium Duty Curb Guard	\$100.00
CG-MD-8	Medium Duty Curb Guard / 8" Punch	\$100.00

WEAR SHOES

Part Number	Description	State
CWS-55	55 Degree Carbide Wear Shoe (1" Base)	\$161.50
CWS-65	65 Degree Carbide Wear Show (1" Base)	\$161.50
CWS-80	80 Degree Carbide Wear Shoe	\$161.50
CWS-85	85 Degree Carbide Wear Shoe	\$161.50
CFS-UNI	Carbide Frame Shoe / Universal Design	\$150.00
CFS-BOAT	Carbide Frame Shoe / Tenco "Boat" Style	\$125.00

<i>PLOW MARKERS</i>		
Part Number	Description	State
PM-30-LD	30" Plow Marker Kit / Fisher Style Base	\$33.00
PM-30	30" Municipal Plow Marker Kit	\$33.00
PM-36	36" Municipal Plow Marker Kit	\$36.00
PM-48	48" Municipal Plow Marker Kit	\$48.00

<i>HARDWARE</i>		
Part Number	Description	State
HWK-SAB-36	Hardware Kit / SAB-36 / 5 Bolt	\$12.50
HWK-SAB-48	Hardware Kit / SAB-48 / 6 Bolt	\$15.00
HWK-SAB-WP	Hardware Kit / Wear Plate / 4 Bolt	\$10.00
HWK-CG-HD	Hardware Kit / Curb Guard / 3 Bolt	\$7.50
HWK-CG-LD	Hardware Kit / LD Curb Guard / 2 Bolt	\$5.00
HWK-VB	Hardware Kit / V-Blade Kit	\$35.00
PB_LENGTH	5/8" Grade 8 Plow Bolt X Length	\$2.00
CB_LENGTH	5/8" Grade 8 Carriage Bolt X Length	\$2.00
NN.625	5/8" Grade 8 Nylock Nut	\$0.66
FW.625	5/8" Grade 8 Flat Washer	\$0.40

sabre <i>CUSTOM</i>		
Part Number	Description	State
CSAB_KIT	Add Flat Rate of 5% for All Custom (Non-AASHTO) Blades Part Numbers of Currently Available Custom Blades in Catalog	

FREIGHT POLICY
 Free freight on orders over \$25,000.
 \$130 pallet rate on orders under \$25,000.
 Pallet = 2,500lbs. = 140ft. Of Sabre

CONTACT INFORMATION		
Matt Aquino Owner, Built Blades	(585)613-6821 info@builtblades.com 111 Parce Ave. STE#7 Fairport, NY 14450	cell email address

Bruce Nichols Sales Representative	(802)770-3881 bruce@builtblades.com	cell email
--	---	---------------

Michael Duell Warehouse	(585)364-0664 warehouse@builtblades.com	office email
-----------------------------------	---	-----------------

Lisa Aquino Billing Inquiries	(585)746-9921 accounting@builtblades.com	cell email
---	---	---------------