



The Farm Tractor in the Forest

"The Farm Tractor in the Forest" is a manual for woodlot owners and small scale woods contractors. It outlines the type of modifications and auxiliary equipment that may be needed if a farm tractor is to be useful in a forestry operation. Guidelines for planning of forestry operations and safe work techniques are also provided. The last sections of the book cover the economic aspects of farm-tractor-logging and provide examples of how to calculate costs to compare different logging systems. The original version of this book was printed in Sweden. Illustrations and most references reflect current Swedish conditions. However, in some places minor changes have been made in the English version to reflect conditions in North America.

© The National Board of Forestry, Sweden
Written by: Milton Nilsson
Illustrations: Nils Forshed
Cover photo: Milton Nilsson
Reference group: Thorsten Andersson
 Karl-Gunnar Lindqvist
 Bertil Svensson
Project leader: Karl-Göran Enander
 Bengt Pettersson
Editor: Bengt Pettersson
English translation: Forest Extension Service
 N.B. Department of Natural Resources
 R.R. # 5
 Fredericton, New Brunswick
 Canada E3B 4X6

The National Board of Forestry, Sweden published **The Farm Tractor in the Forest** by Milton Nilsson in 1982. In August 2017 the Swedish Forest Agency, successor organization to the National Board of Forestry, granted Vincent Seiwert of Bombadil Tree Farm, Ashland, Maine, U.S.A. permission to reproduce and disseminate **The Farm Tractor in the Forest** for noncommercial purposes as he deems appropriate.

You may download, save, print, and/or share this PDF version, prepared by Vincent Seiwert from his English translation copy of the book, in its entirety or in part, so long as you abide by the same noncommercial purpose restriction.

07 September 2017

Contents

When can I use my farm tractor in the forest?	2
The basic farm tractor	4
The forestry equipped farm tractor	8
The power take off shaft	13
The tractor trailer	16
Winches	20
Mounting a mechanical winch on a farm tractor	23
Cranes	26
Mounting the crane and attaching the trailer	31
Grapple loaders	37
Accessories	38
Cables	46
Control and maintenance of equipment	54
Personal safety equipment	60
Off-road driving technique	61
Planning the harvest operation	66
Choice of logging method	70
Shortwood to strip road	74
Tree length or tree sections to strip road	78
Tree length to landing	80
Shortwood to landing	86
Economy	92

**When can I
use my farm tractor
in the forest?**



Almost any farm tractor can be put to a variety of forestry uses but do not expect it to replace a skidder or other specialized machine designed specifically for forestry. This handbook outlines some of the safety features and equipment that can be added to a farm tractor being adapted for woods work. When combined with proper work techniques, this equipment is suitable for small scale forestry operations.

Some factors to consider

... Do you have spare time when your tractor is not needed around the farm?



... Are the woodlot strip roads on firm ground with no major obstacles or large hills?



... Can you afford attachments to adapt the tractor for forest operations?

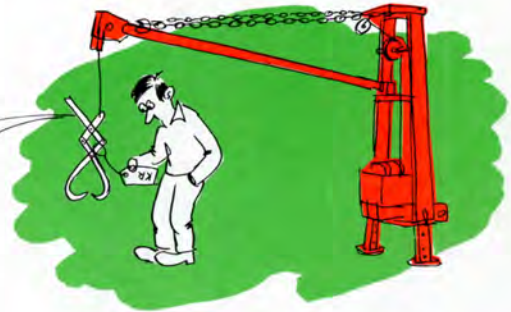

... Do you want to employ forest management techniques that have minimum impact on the environment?



... Do you want to do the work yourself?



The basic farm tractor

This illustration shows a tractor equipped to meet Swedish farm safety standards. Standards may vary in other jurisdictions. It may be worthwhile considering installation of this type of safety equipment even if it is not required by law in your country.

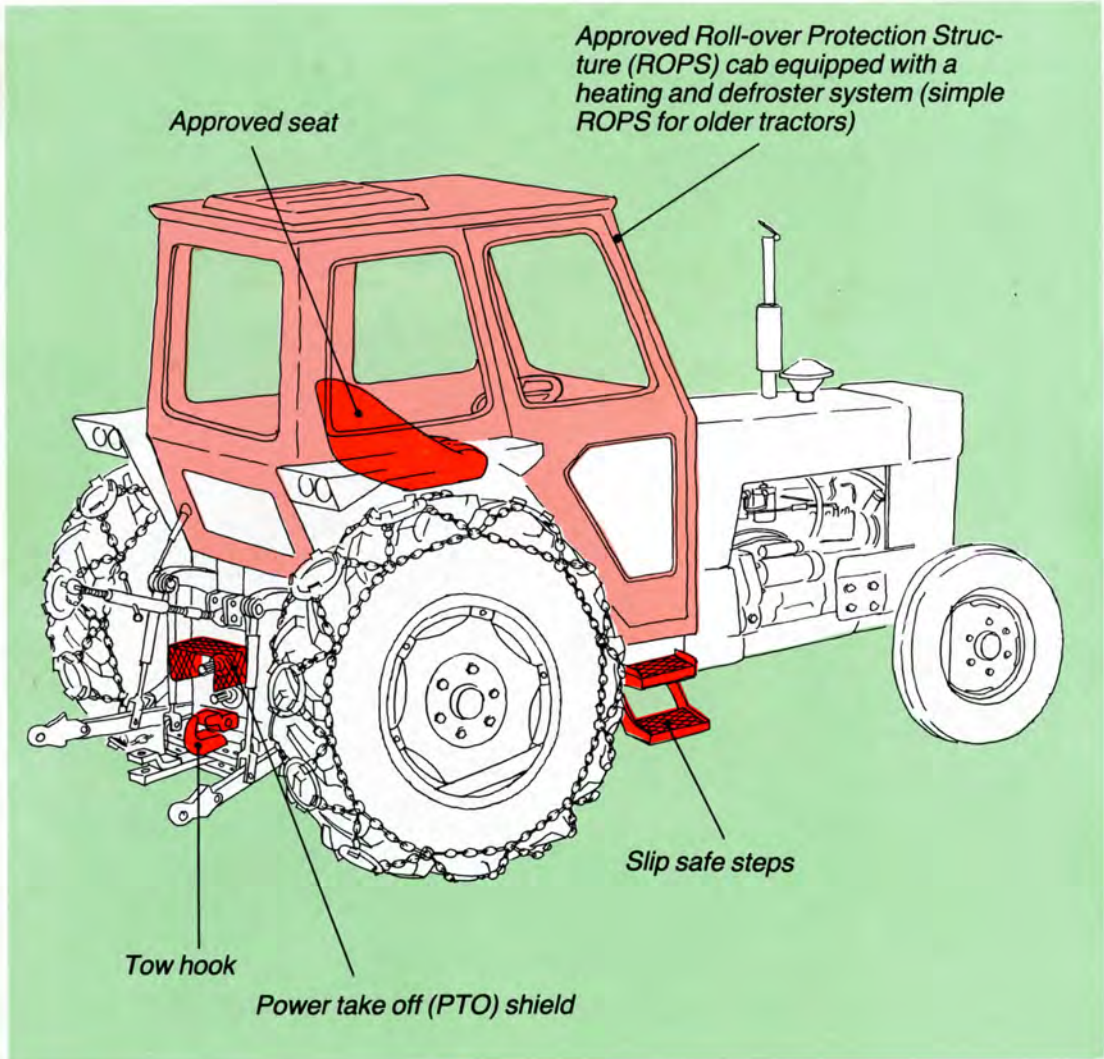

**If used on public highways,
the tractor must comply with local
traffic regulations.**

The Cab

The tractor should be equipped with an approved cab or roll-over protection structure for safety reasons. In northern climates, a good heater—defroster is necessary when working in the winter. Air conditioning may be appropriate in other climates.

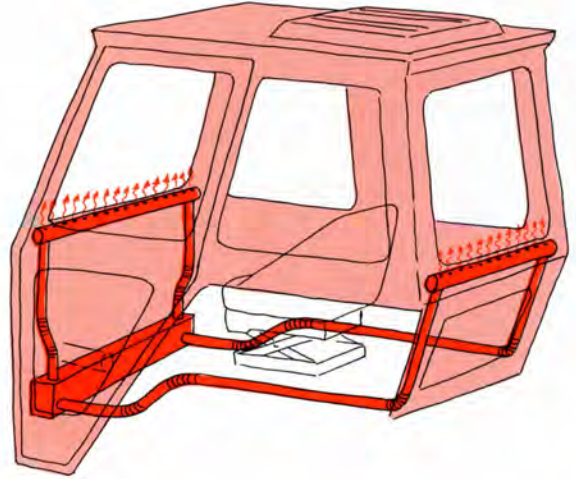

If a tractor with a cab is operated on frozen lakes or rivers, it should have an escape hatch or removable roof on the cab.



Never drill, weld or make any structural change in the cab frame or roll-over protection structure.

The Seat

A farmer or woodlot owner may spend over 1,000 hours per year on the seat of the tractor. Unless the machine has a properly designed seat, the operator may end up with backache, disc degeneration, stomach or kidney problems resulting from the vibration and bouncing of the tractor.

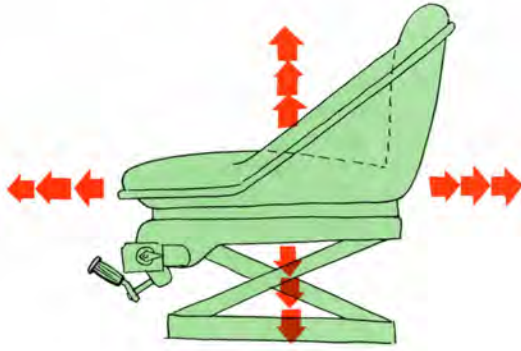

A well-designed seat will support the operator's backbone in a natural way, allowing it to absorb machine vibrations. The seat should have adjustable dampening or springs adaptable to the weight of the operator. It should be adjustable both horizontally and vertically.

It is not enough to just have a well-designed seat. The seat must be maintained and checked regularly to ensure the springs or dampening systems are working properly.

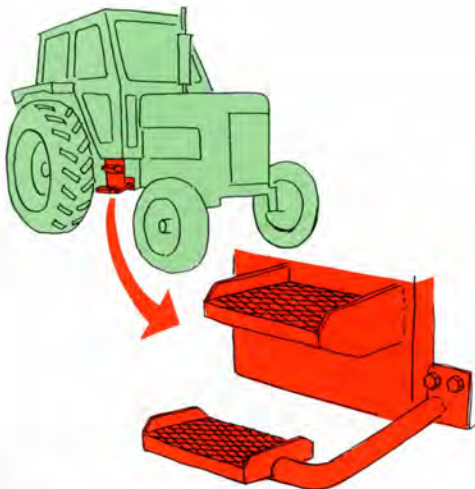
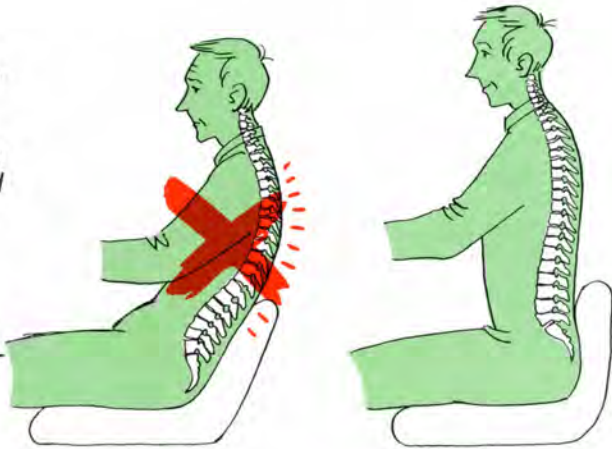

Steps

For safety reasons the tractor should have perforated, anti-slip steps designed to prevent accumulation of soil, snow or ice.

If the tractor does not have anti-slip steps, it is relatively easy to weld on a strip of expanded metal to give the steps anti-slip properties.

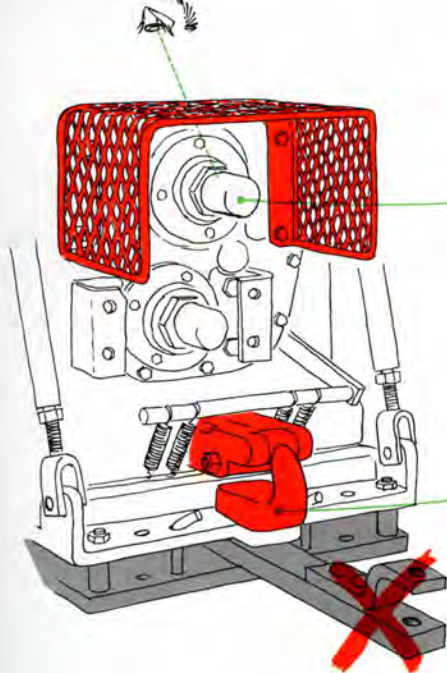

The power take off (PTO)

The power take off should have a permanently fixed shield. A pipe-shaped shield on the PTO shaft should cover all moving parts. If the PTO shield on the tractor is made of expanded metal the operator has a better view of the hitch when hooking up a trailer.

The tow hook

The tow hook should be mounted as close to the tractor axle as possible to minimize the risk of a back roll-over (back flip) or a side roll-over of the tractor. The hook should be designed so that the trailer cannot disconnect accidentally.

Some tractors have a combined farm-equipment drawbar and a hydraulically controlled tow hook. The drawbar should be removed to increase clearance for forestry work.

For safety and convenience

Two-Way radio

Forest work involves many dangerous activities. A two-way radio in the tractor can be used to summon help in an emergency.

Anyone working alone in the woods should carry a portable transmitter in his pocket to use in an emergency. Make sure someone is monitoring a base-station tuned to the frequency of your transmitter.

A two-way radio is also a convenience. It can be used to tell visitors where you are working, tell the family when you will be home for dinner, or seek advice from a friend or co-worker elsewhere in the forest.

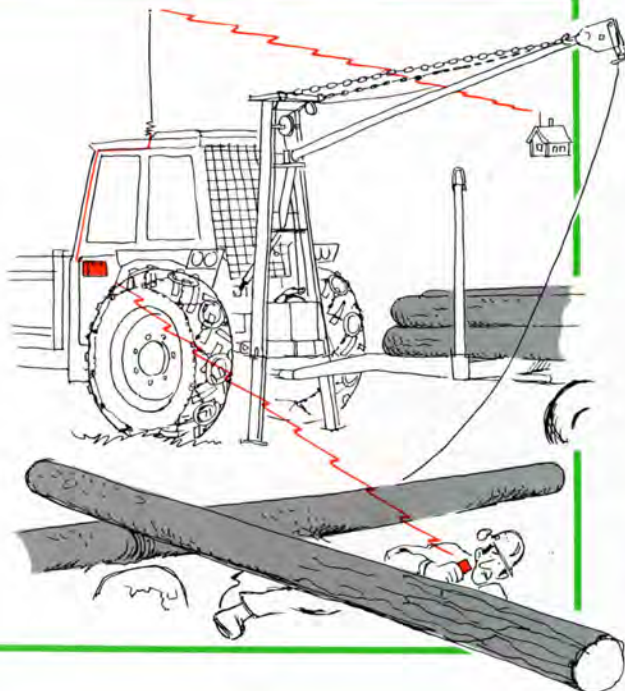

The forestry equipped farm tractor

Equipping a farm tractor for forest work does NOT make it into a skidder. Such a conversion is not economical.

The equipment added to the tractor should be easy to disconnect when the tractor is needed for farm work. The type of equipment selected will reflect the amount of forest work contemplated and the economic return from forest products.

Few manufacturers provide standardized forestry equipment for farm tractors. The owner with access to a workshop and welding equipment should have little trouble fabricating basic equipment like a belly pan, radiator protector and other small items.

Basic equipment for the forestry-equipped tractor includes:

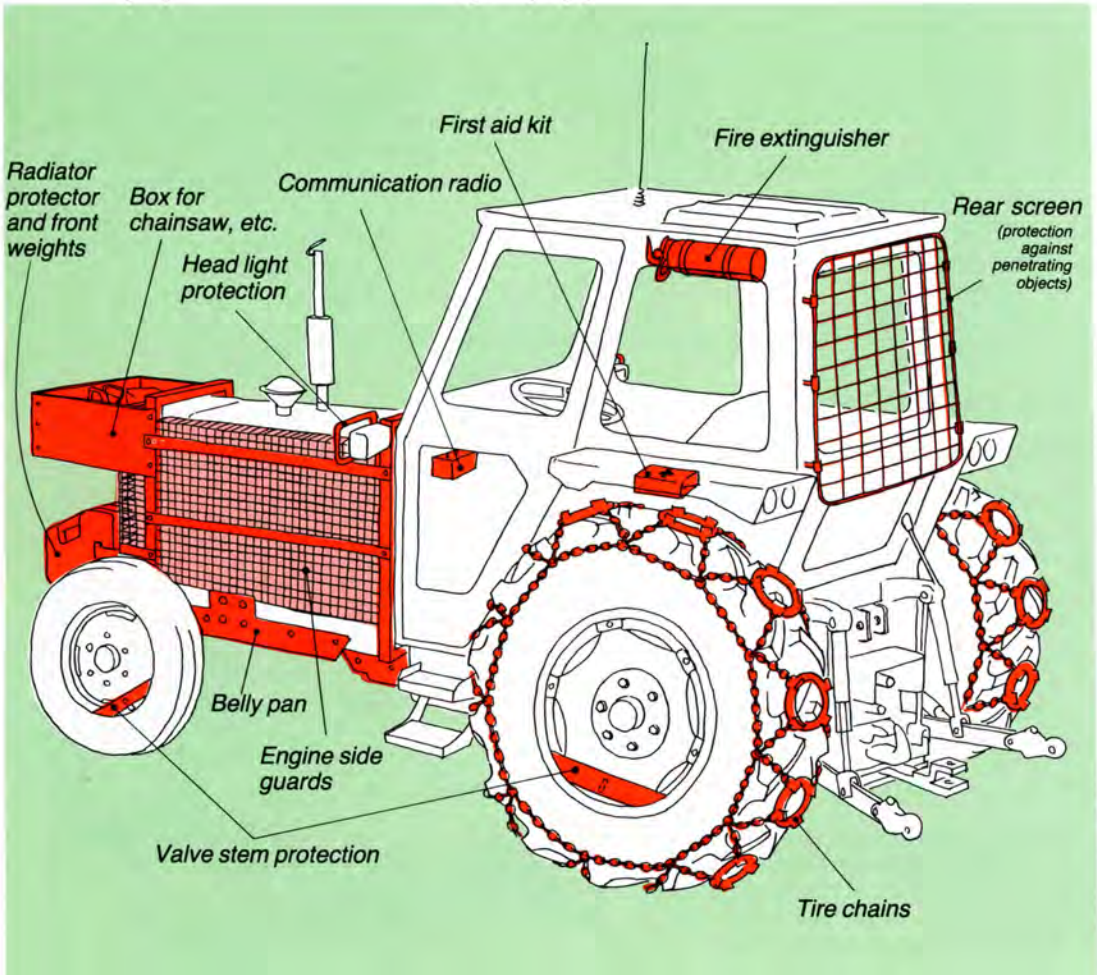

Protective screen

A metal mesh screen will protect the rear window and rear section of the tractor when loading with a crane.

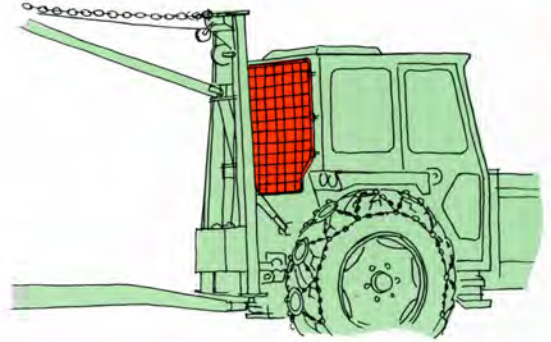

Screens should be installed on both rear and side windows when a grapple loader is used.

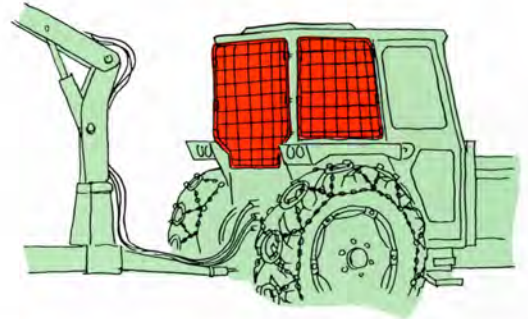

First aid kit

The kit should contain first aid bandages, band-aids and gauze bandages.

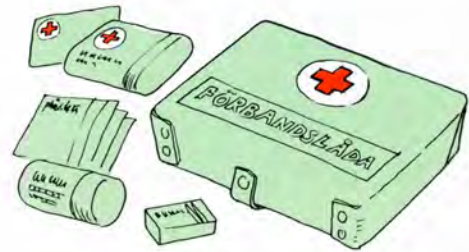

Belly pans

Belly pans are necessary to protect the motor, transmission and front axle. The protective pans should be made of metal at least 10 mm thick. Curving the pans increases their strength and improves protection against knocks and blows. Curved belly pans reduce the risk of hanging up on stumps or other obstacles.

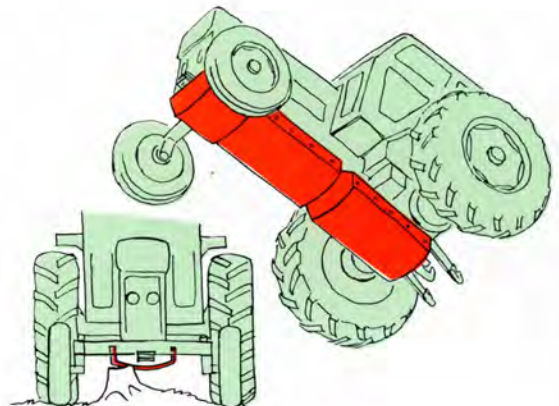

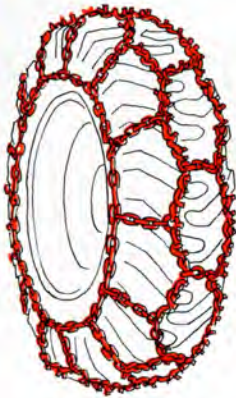

Chains with V-shaped studs (lugs)

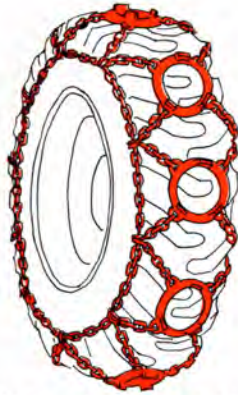

Chains with studded rings

Tire chains

Tire chains improve the off-road capabilities of a farm tractor. Some jurisdictions restrict their use on public roads because of potential damage to the road surface. Instructions for mounting tire chains are found on page 45.

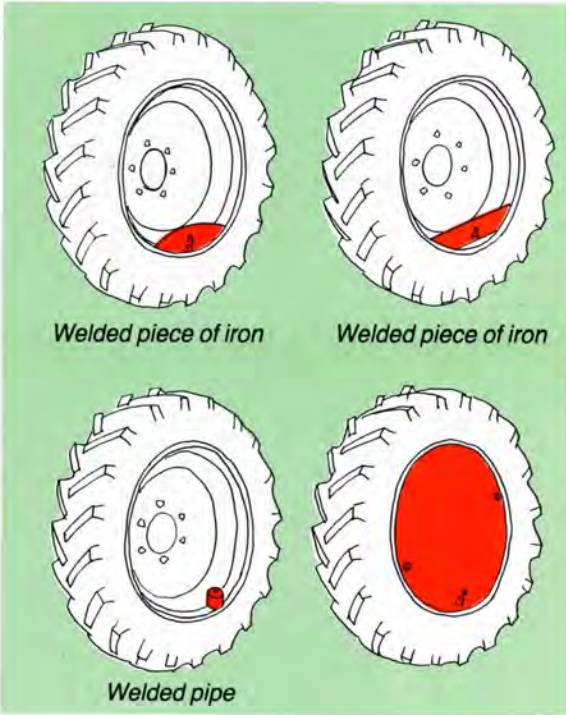

Welded piece of iron

Welded piece of iron

Welded pipe

Valve stem protection

Valve stems are easily damaged in off-road work. If a tractor is to be used in the woods, weld valve protectors onto the tire rims before the tires are mounted.

The valve protector may cover just the valve stem or the whole rim.

Fully covering protective disc, bolted to the rim.



Because of the danger of explosion, never weld a rim when it has a tire mounted on it.

Radiator protector

This metal mesh screen must be strong enough to prevent branches from puncturing the radiator.

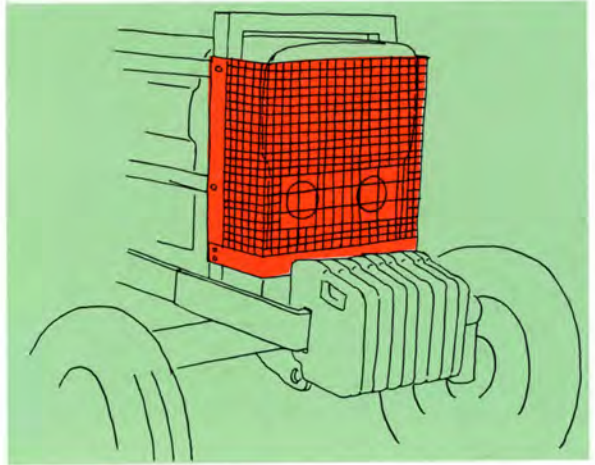

Equipment box

A box for the chainsaw, fuel and oil containers and small logging equipment can be installed on the front of the tractor. DO NOT store this equipment on the floor of the tractor cab. Make sure the equipment box does not obscure headlights or licence plates.

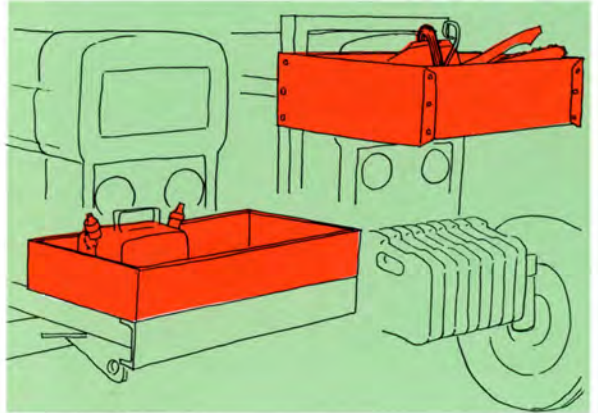

Engine side guard

Removable metal screens or sheet metal protectors will shield the motor compartment during woods operations. An approved container with extra fuel could be mounted on this screen.

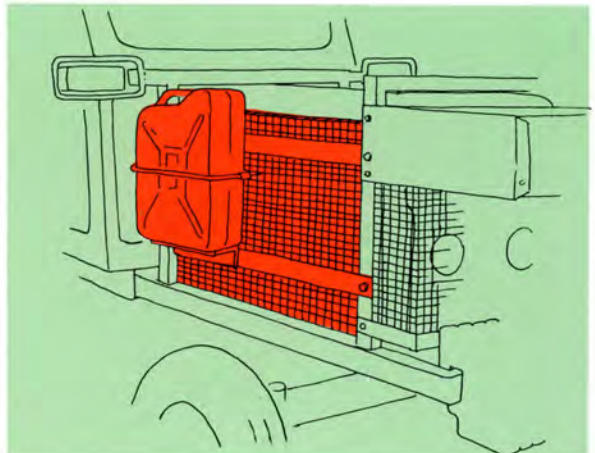

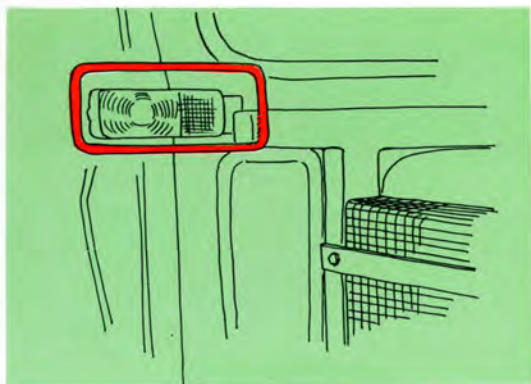

Headlight protection

Provide protection for headlights, flashers and position lights when working in the forest.

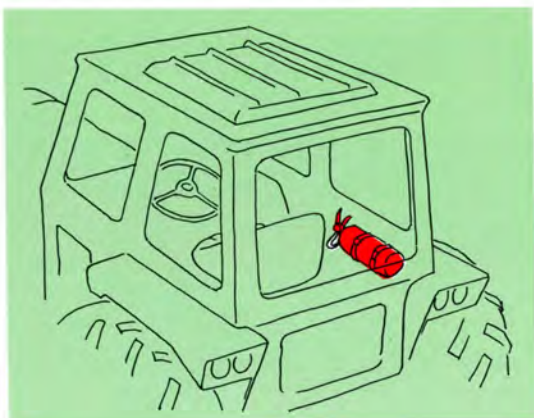

Fire extinguisher

Spilled fuel or dry material from the forest floor can easily catch fire. Carry a fire extinguisher designed for use on gas, oil, electric and wood/paper fires. A 6 Kg type fire extinguisher is recommended.

Tractor stability

Increasing the distance between the wheels improves the stability of the tractor. Some front axles are designed to be extended. Rear rims can be installed "inside out" to increase the distance between the wheels. Special extenders are also available for rear wheel mounts.

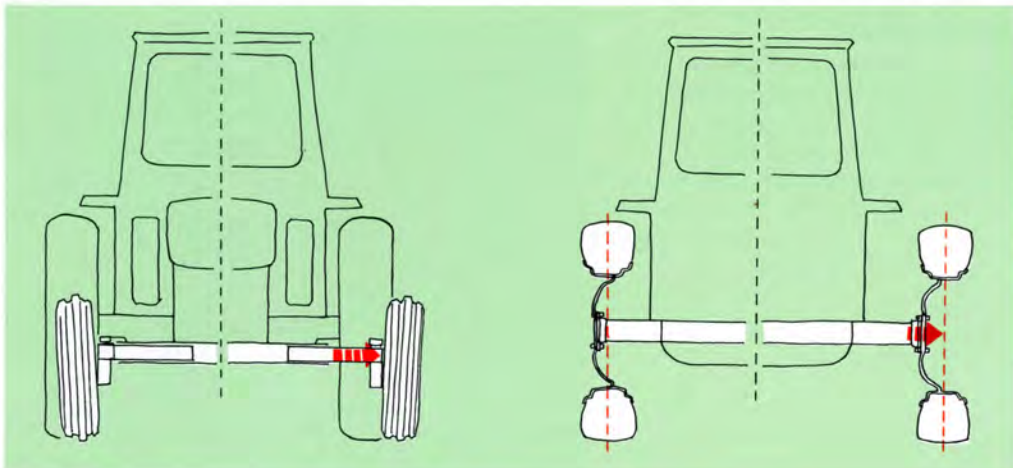

The power take off shaft

A power take off (PTO) shaft is normally made up of the following components:

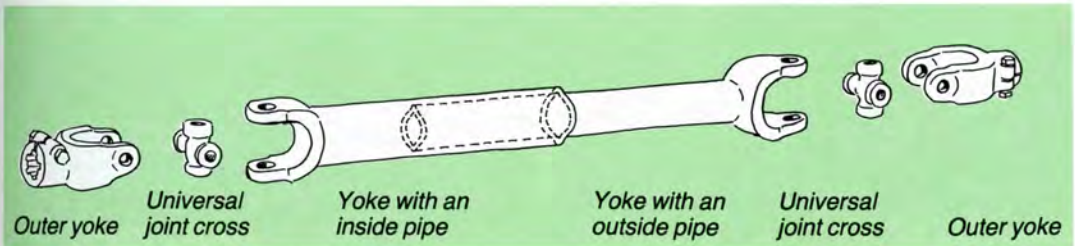

Outside yokes

The outer yokes can have different dimensions, profiles and fasteners.

It is therefore important to know the correct dimensions, profile and fastener type when ordering a PTO shaft.

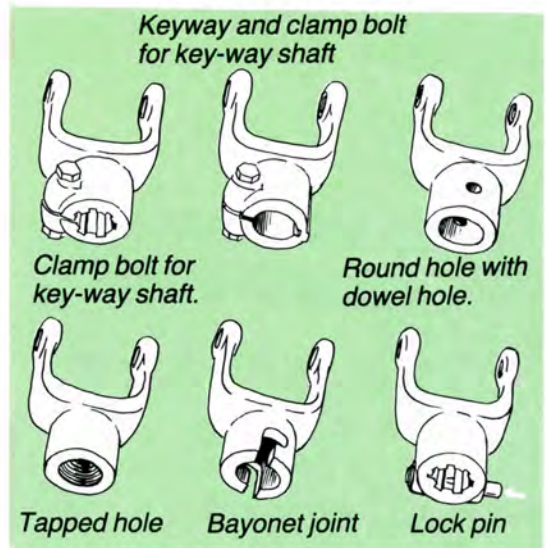

Universal joints

There are three different kinds of universal joints on the market. Only the conventional universal joint is used for winches and cranes.

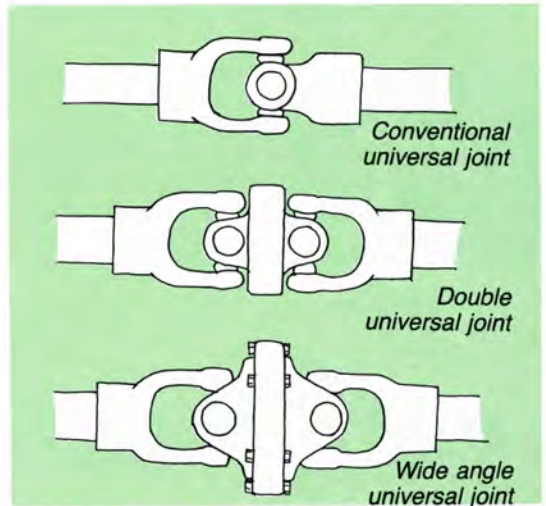

The conventional universal joint can operate at an angle of up to 35°. This is sufficient to permit lifting or lowering a winch or a crane.

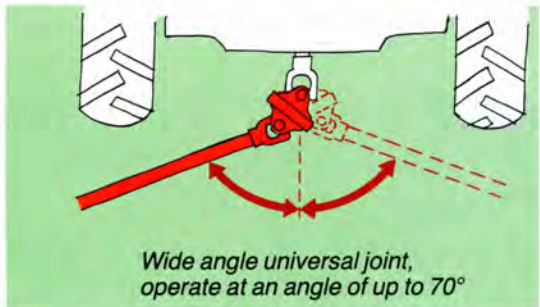
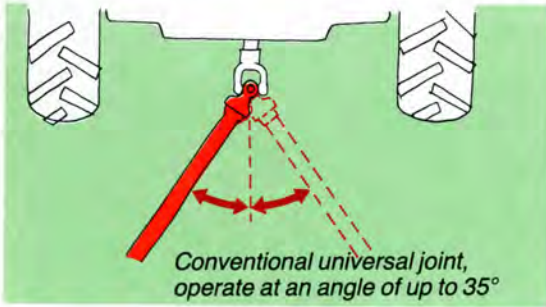

Measure

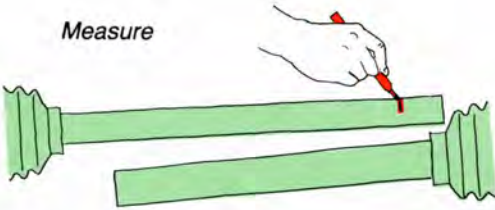

Correct shaft length

It is important to make sure that the shaft is the correct length so that it is not damaged or pulled apart when the hitch is raised or lowered. If the shaft is too long, cut it, remove burr and lubricate.

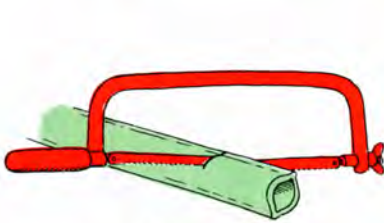

Cut



Remove burr



Lubricate

Lubrication

PTO shaft will last longer if properly lubricated. Insufficient lubrication can result in damage to bearings, overheating and increased telescopic resistance. Lubricate as recommended below:

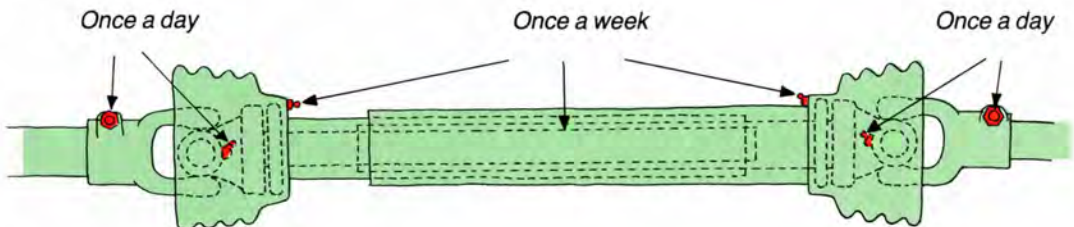

PTO shaft shields

The PTO shaft must be fully covered by a protective shield. The universal joints at the tractor end and machine end must have permanently mounted shields. The pipe shaped PTO shield must be fastened with two chains, one in each end, to prevent rotation. A damaged shield must be immediately replaced. Never wait to replace a damaged shield.

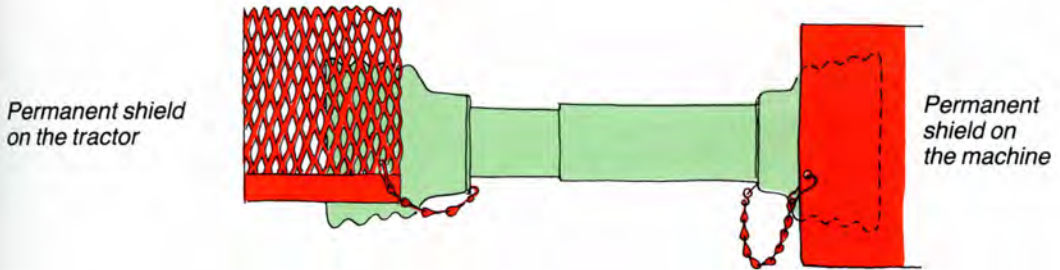

The permanent shield over the tractor PTO should withstand a heavy blow (1,200 Newton). The shield should never be removed. If the shield is made of a metal mesh or stretch metal, you can see through while hitching on a trailer.

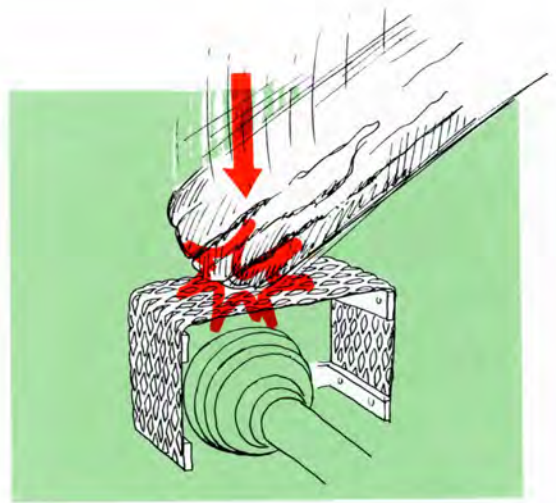

When the tractor PTO is not in use, the PTO outlet cover should be in place.

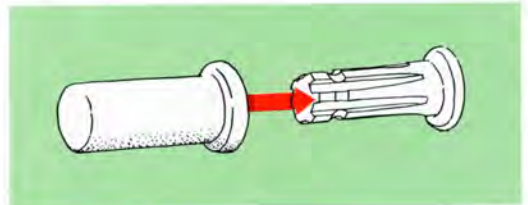

If a section of the PTO shaft is damaged it is generally cheaper to purchase a new shaft or use used spare parts rather than repair the broken component.

The tractor trailer

A trailer is a single axle vehicle that may be equipped with either single or bogie wheels. Wagons have multiple axles and are not suited for forestry operations.

Trailers are better in the forest because part of the weight of the load is on the tractor, increasing traction. A tractor-trailer combination is more maneuverable than a tractor-wagon combination.

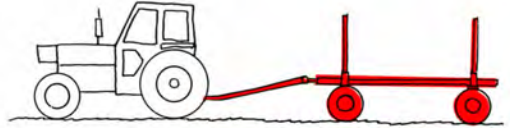
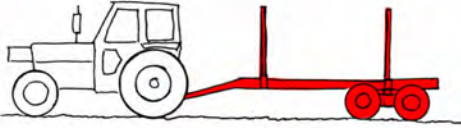

A good trailer for forest work will have:

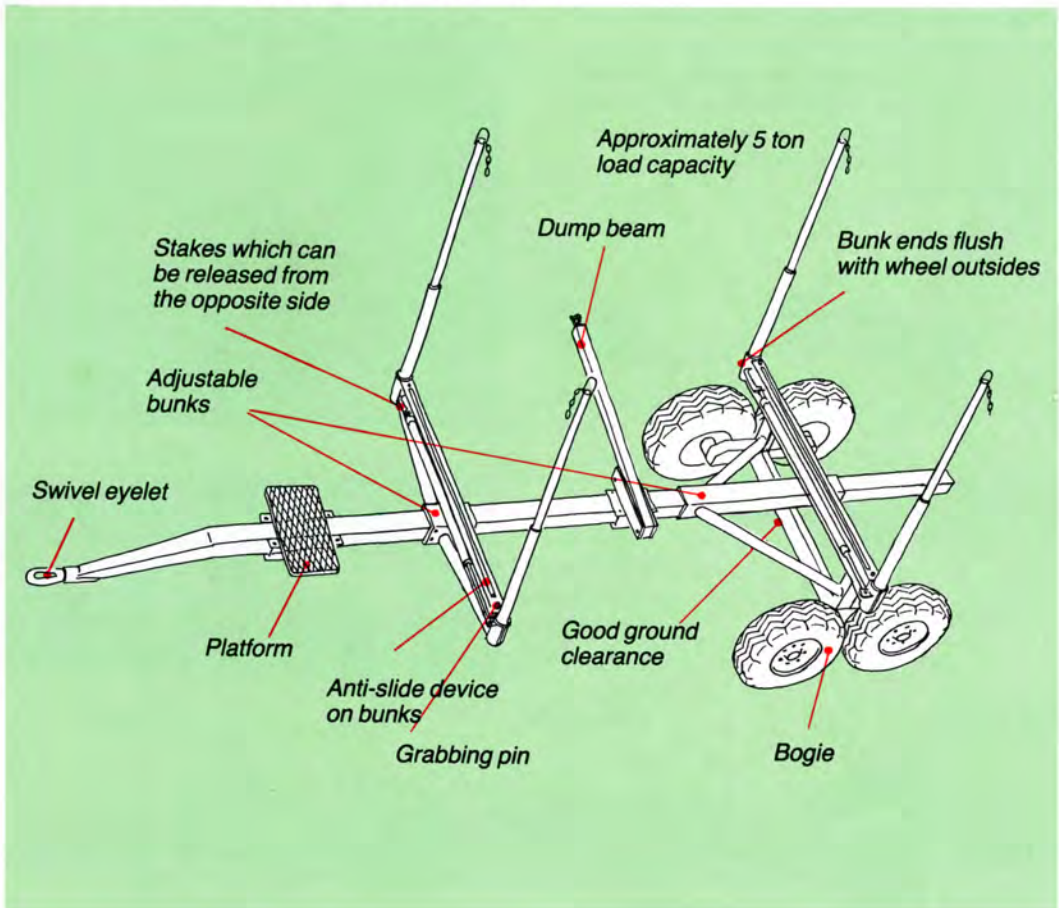

Five-ton capacity

A five-ton trailer should suit most farm tractors.

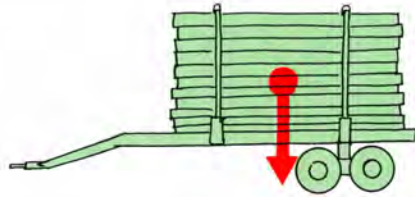

Platform

A small platform should be provided for use when adjusting the load.

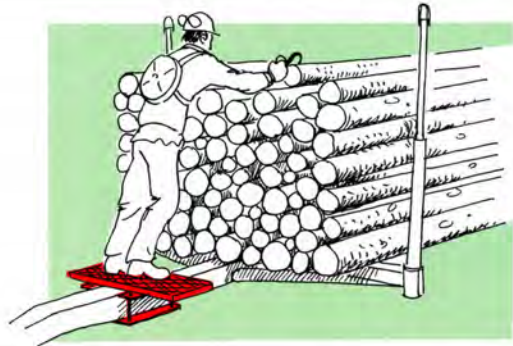

Swivel eyelet

A revolving eyelet improves off-road handling.

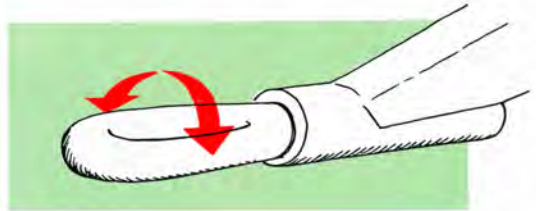

Bogie

The bogie should be equipped with wheels which have valve stem protectors and tires approximately 8.50x12. The bogie pivot should be slightly toward the rear of centre to allow the bogie to easily "climb" an obstacle.

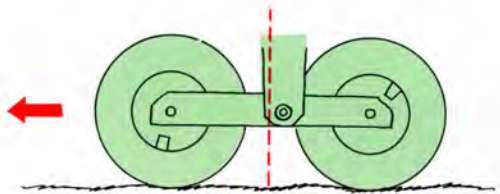

Good ground clearance

The trailer should have good ground clearance, low loading height and a "clean" underside.

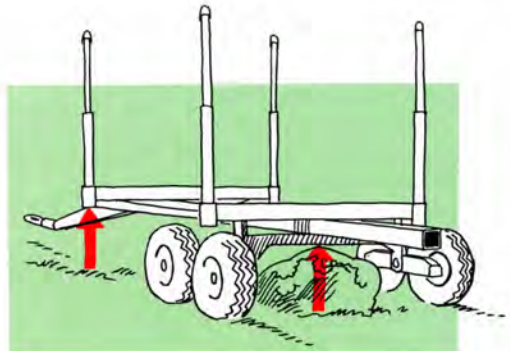

Adjustable bunks

Adjustable bunks make it possible to carry products of varying lengths.

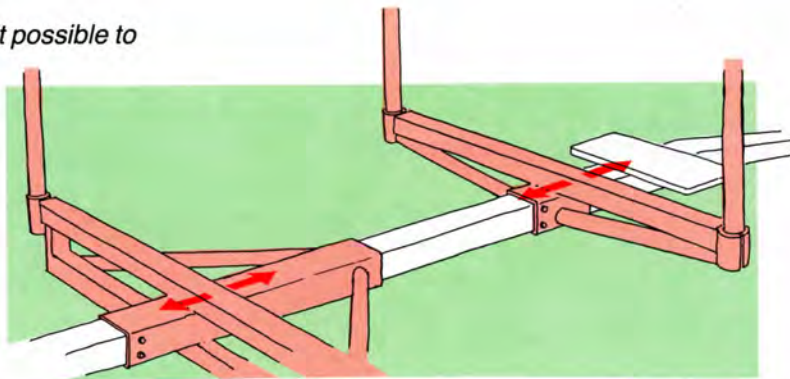

Load width

Keeping bunk ends inside the wheel spacing will reduce the chance of damaging trees along the trail.

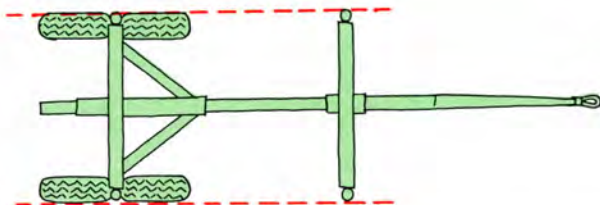

Stake releases

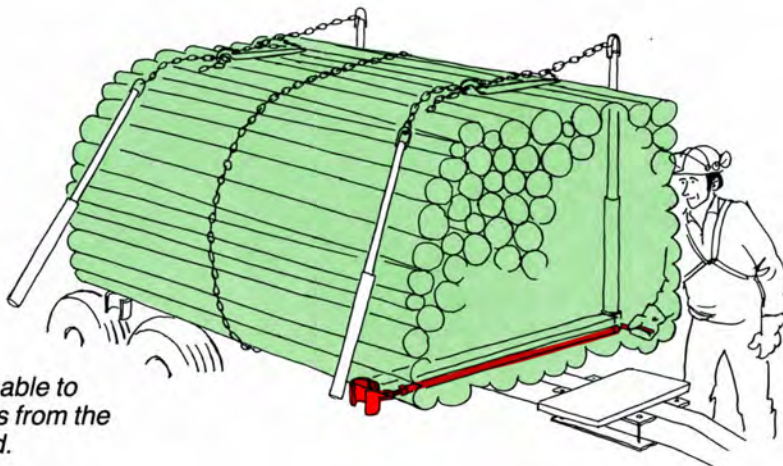

The operator should be able to release the trailer stakes from the opposite side of the load.

The stake socket should be adjustable.

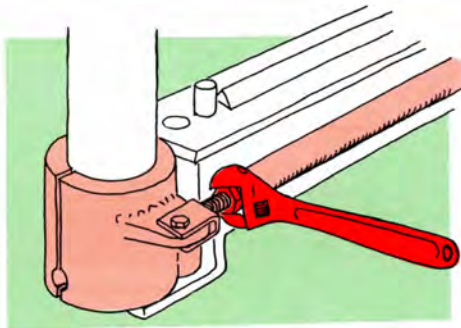

Dump beam

A dump beam (described on page 43) can make unloading easier.

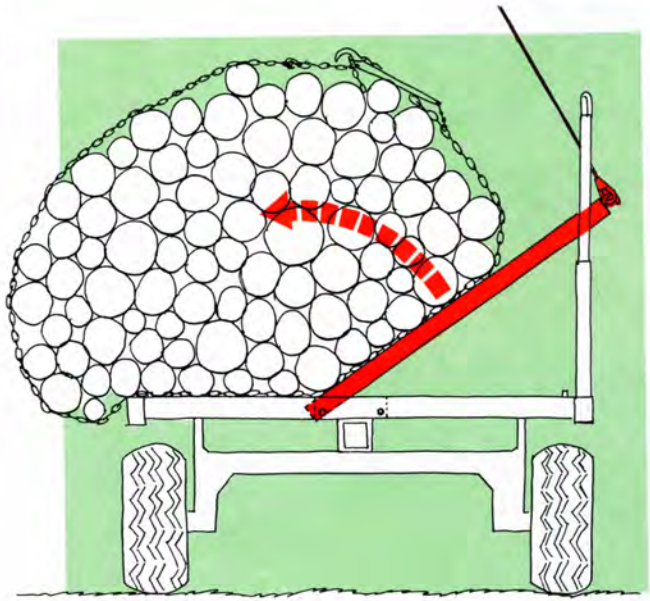

Anti-slide device

Anti-slide devices on the beams prevent the wood from sliding forward or back. An inverted angle iron welded to the trailer bunk will do the job.

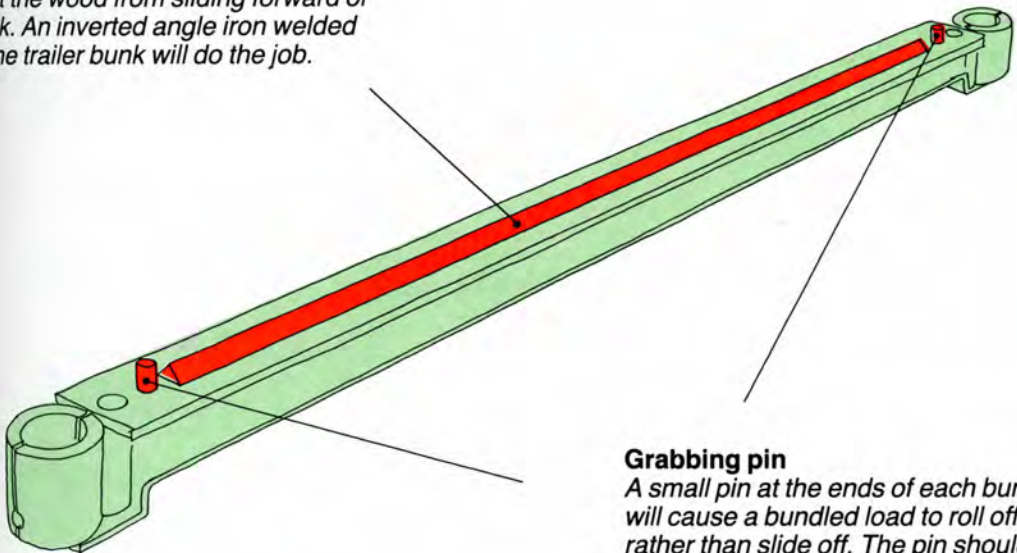

Grabbing pin

A small pin at the ends of each bunk will cause a bundled load to roll off rather than slide off. The pin should be 2 cm higher than the anti-slide device.

Winches

The winch can be either mechanically or hydraulically powered.

There are drum winches, multi-groove roller winches and capstan winches. Winches equipped with towers which can be tilted are called tilt winches.

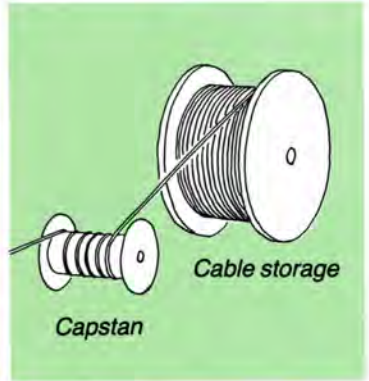
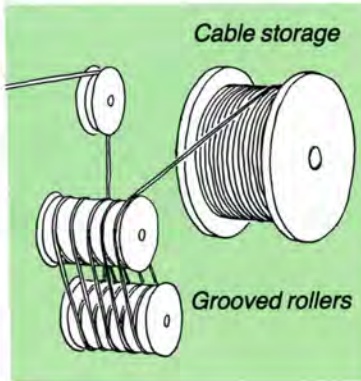
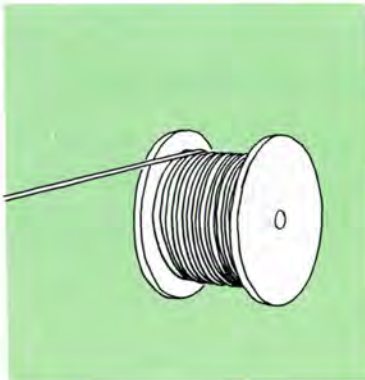

Drum winch

The cable is pulled in by the drum which also acts as the cable storage.

Pulling power varies depending on the amount of cable stored on the drum.

The cable must be hauled out by hand.

The cable will wear quickly on a drum winch.

This type of winch is relatively inexpensive.

Multi groove roller winch

The cable is pulled in or fed out by a number of grooved rollers.

This type of winch develops constant pulling power regardless of the amount of cable on the separate storage drum.

There is less cable wear than with a drum winch.

This type of winch is expensive.

Capstan winch

The cable is pulled in or fed out by a single capstan.

The cable is stored on a separate drum.

The capstan exerts a constant pulling power on the cable.

There is less cable wear than with a drum winch.

This type of winch is expensive.

Most woodlot owners use a farm tractor and winch in the woodlot for only a short time each year. In these situations the mechanical drum winch is usually chosen because of its low cost.

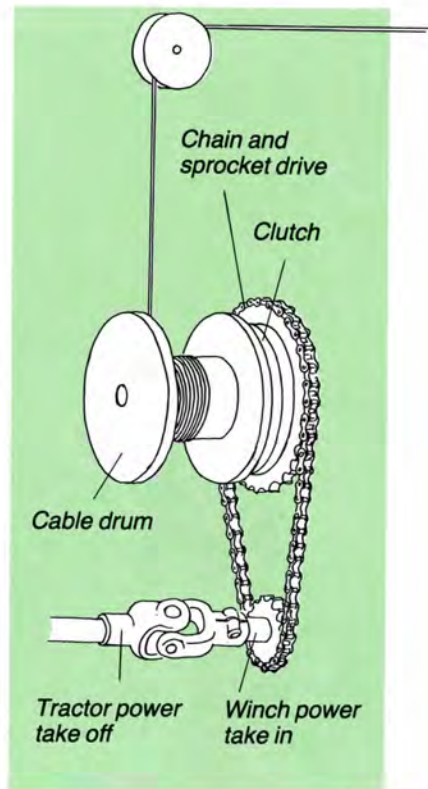

Mechanical drum winch

A mechanical drum winch consists of a drum mounted on a frame with adjustable support legs. Usually the winch frame can be mounted on the three-point hitch of a farm tractor.

The winch is powered by the tractor PTO. There is usually a chain and sprocket drive mechanism with some

form of friction clutch to transfer power to the cable drum.

The cable drum usually has a friction brake to prevent speeding and tangling when the cable is being pulled out.

Always follow the manufacturer's specifications when adjusting the clutch or friction brake.

A typical mechanical drum winch

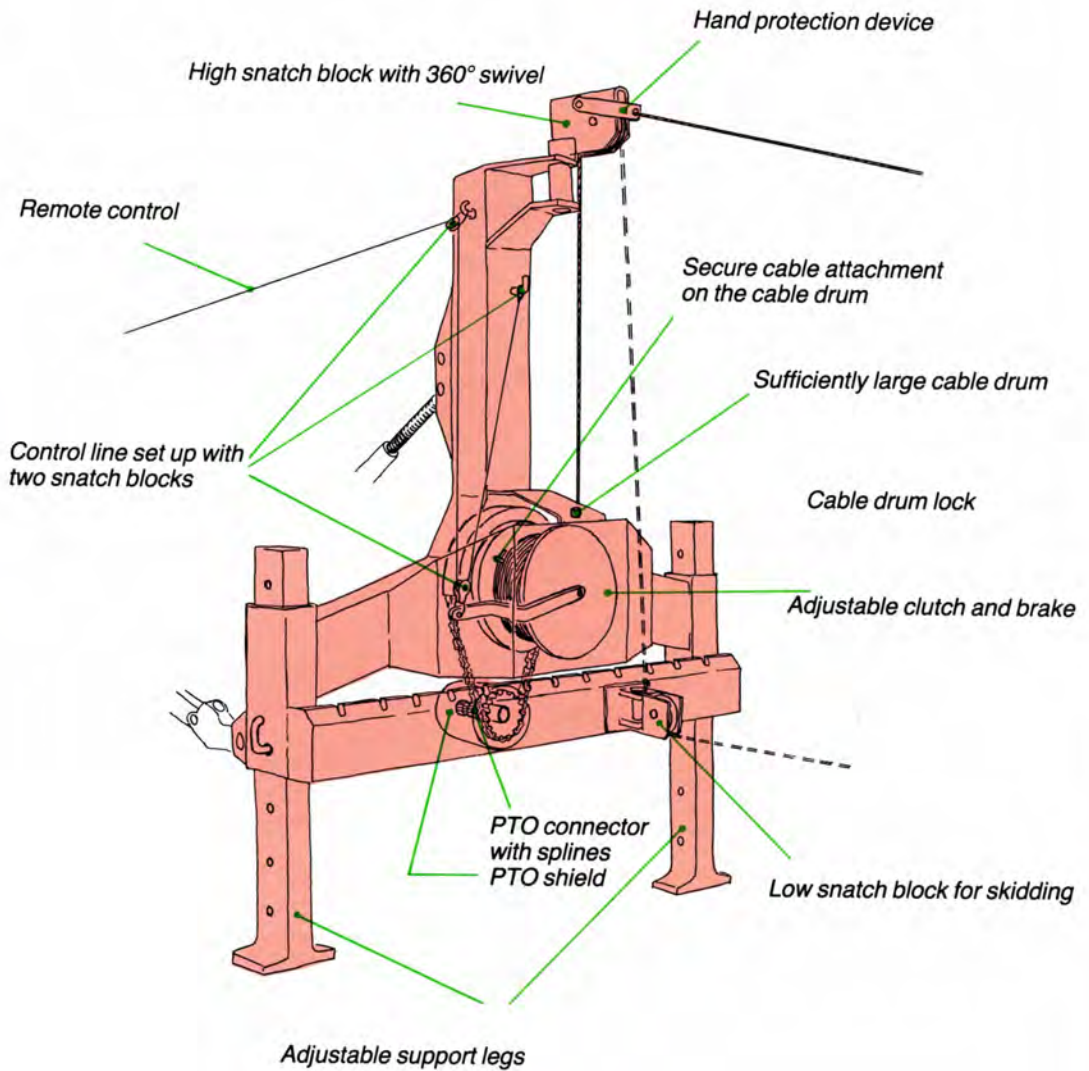

Mounting a mechanical winch on a farm tractor

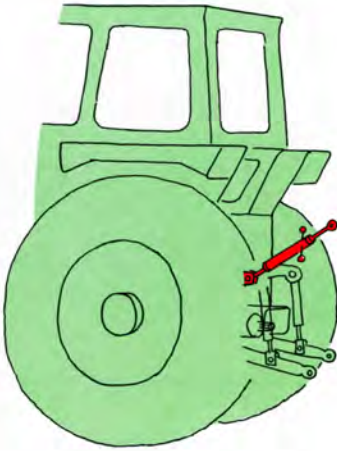

1. Attach the top link to the tractor.

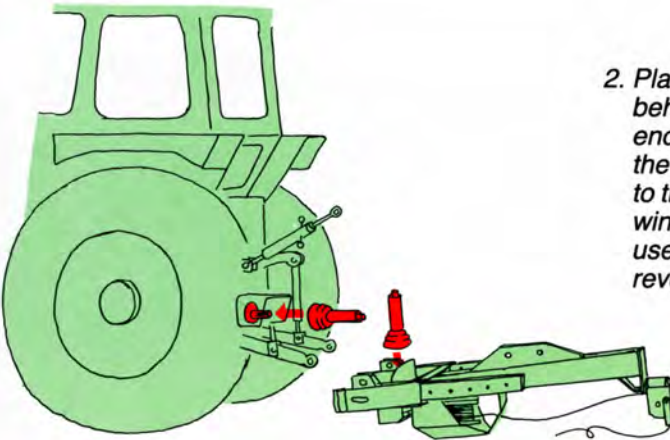

2. Place the winch on the ground behind the tractor. The top side will end up facing the tractor. Divide the PTO shaft and attach one half to the tractor, the other to the winch. If the tractor has two PTO's, use the one which turns at 540 revolutions per minute.

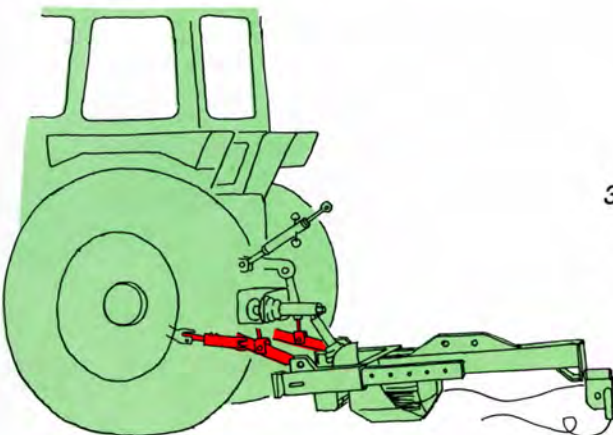

3. Back the tractor into position, extending the sway bars if necessary. Connect the lower links of the three-point hitch.

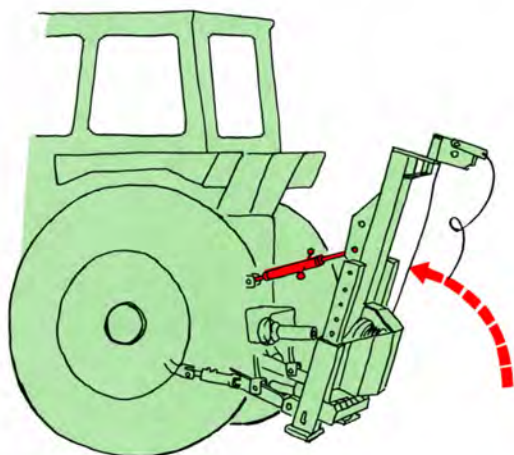

4. Tip the winch up and fasten the top link. Shorten the sway bars so the winch does not sway sideways.

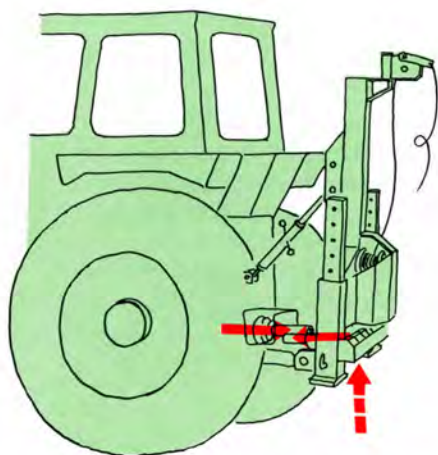

5. Raise the winch until the PTO inlet on the winch is level with the outlet on the tractor. This is usually the point at which the PTO shaft is shortest.

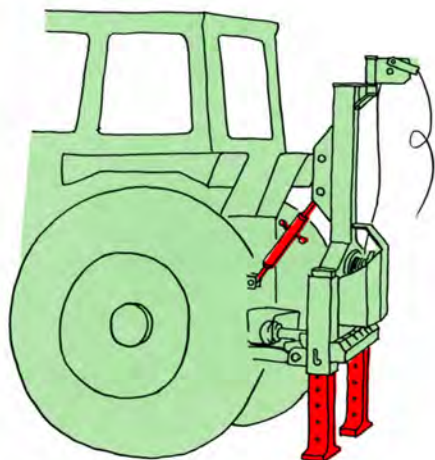

6. Lower the winch support legs. Adjust the top link of the three-point hitch to ensure the winch does not lean toward the tractor. Make sure the clutch on the winch operates freely. Lock the top link.

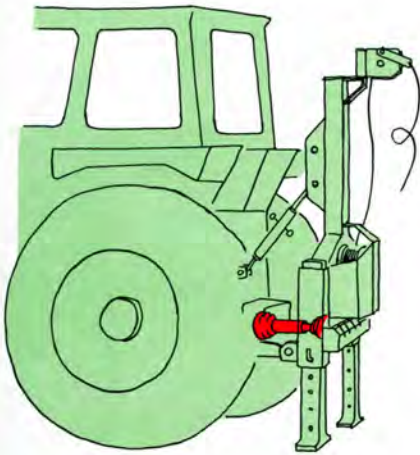

7. **Mounting the PTO shaft:** Place the two shaft sections next to each other and make sure the shaft is long enough when the winch is lifted. Cut the shaft if it is too long. Lower the winch. Remove the tractor PTO section. Push the two sections together and refasten the tractor PTO section. Attach the PTO shield halves so that they do not rotate.

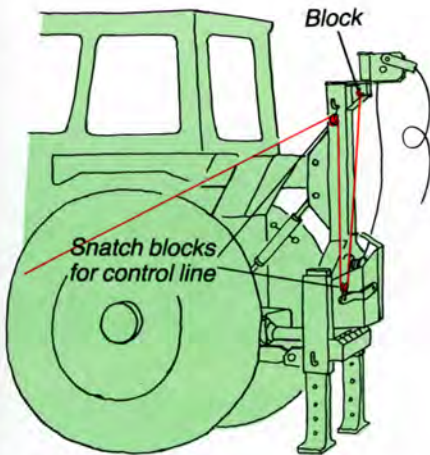

8. **For remote control attach a control line or radio control unit.** If you use a control line, make sure it does not interfere with winch operations.

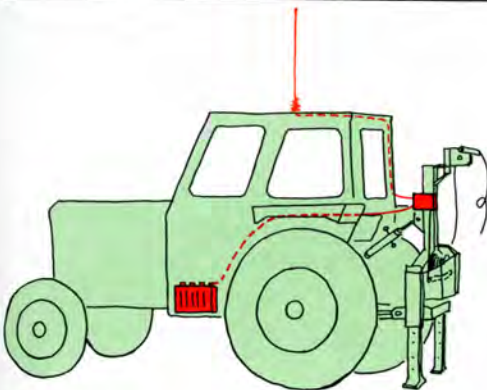

If a radio control unit is used, connect the radio to the tractor battery and install an antenna on the roof of the cab.

9. **Adjust the winch clutch and brake according to manufacturer's specifications.**

Cranes

A cable crane consists of a winch attached to a crane frame which has a lifting boom.

Some cranes are designed to allow the crane frame and boom to be removed so that the winch can be used alone.

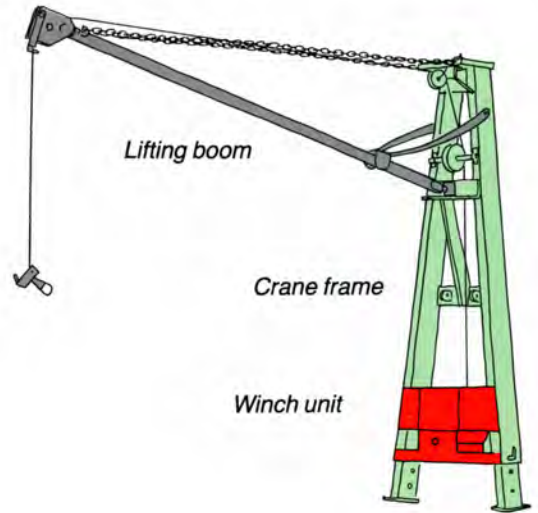

Cranes mounted on tractors are more common than cranes mounted on wagons or trailers. The tractor-mounted crane results in less total vehicle length.

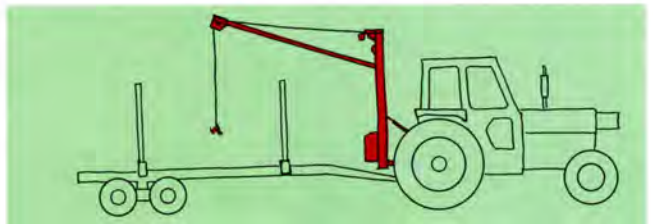

The trailer mounted crane has the advantage of being easily separated from the tractor. But the PTO shaft is longer and more exposed to stress. The trailer unit is less stable in early stages of loading.

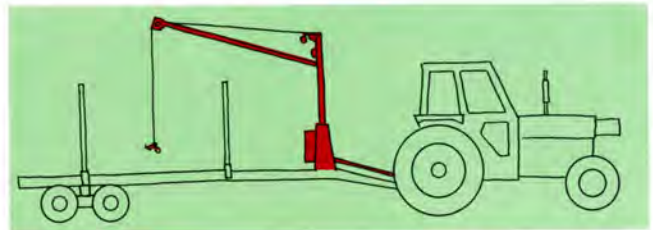

The winch used is usually a mechanical drum type powered by the tractor PTO. The winch must have an automatic brake that will engage if the controls for the clutch or friction brake are released.

A crane should be equipped for remote control with a control line.

Warning: Do not use a one-channel radio remote control for loading and unloading operations since this kind of unit lacks an emergency stop function.

Crane specifications

Recommended measurements are indicated in the sketch.

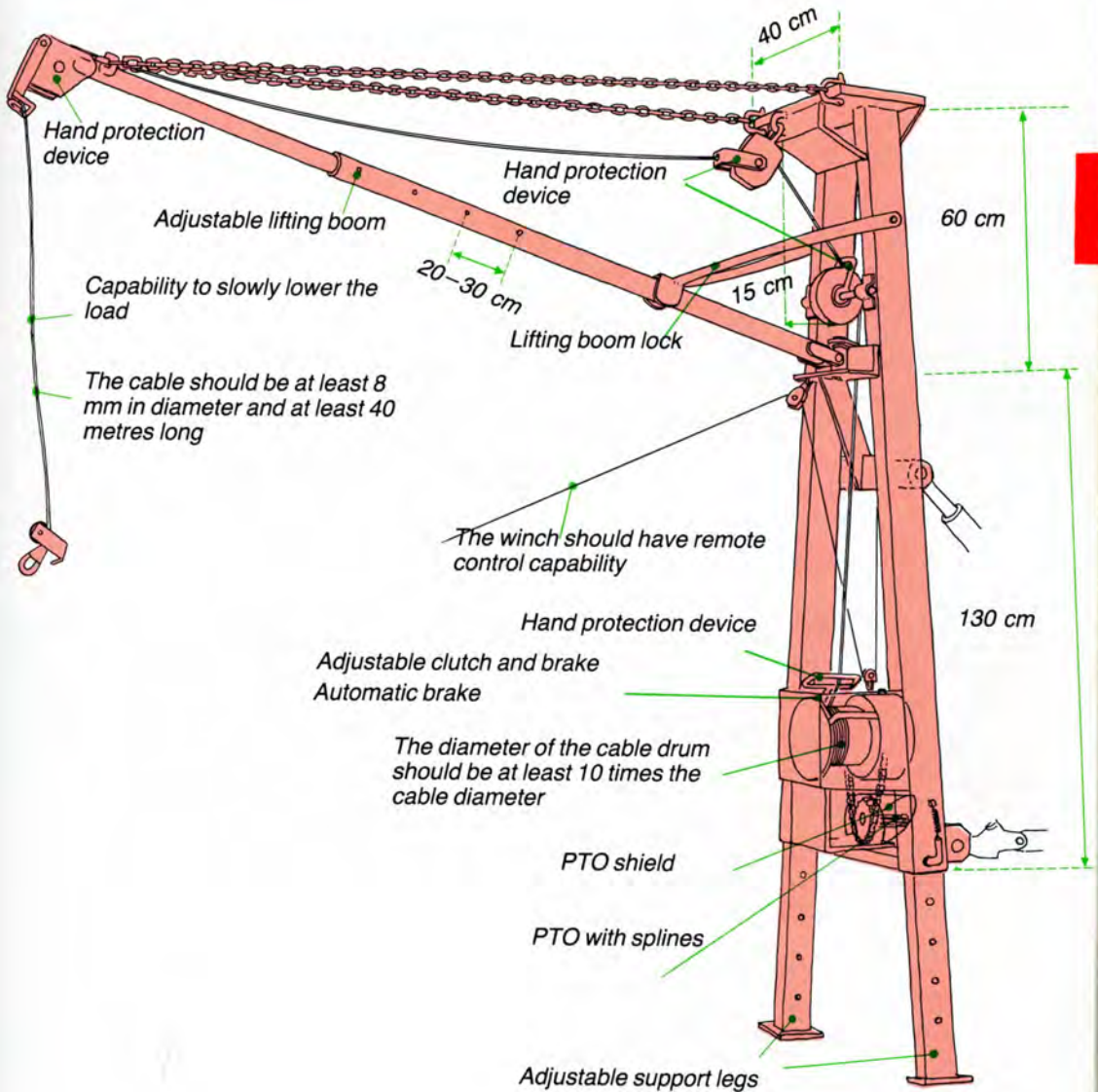

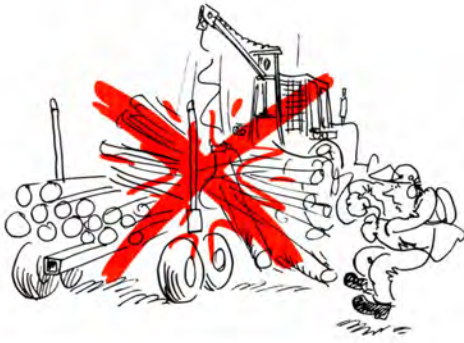

An automatic brake must be able to stop the wire drum any time the drive power is removed. This is a safety feature to prevent a hoisted load from free-falling back to the ground.

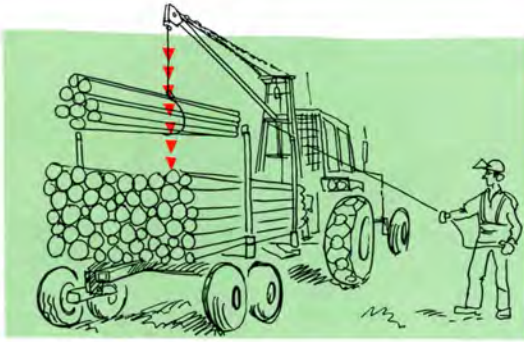

The crane should be designed to allow for slow lowering of a load.

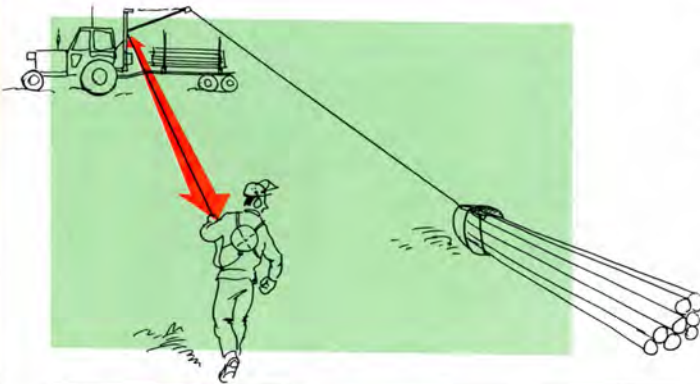

Remote control

Always work alone when winching, loading or unloading. Serious accidents have happened when the crane operator misunderstood a fellow worker who was acting as choker.

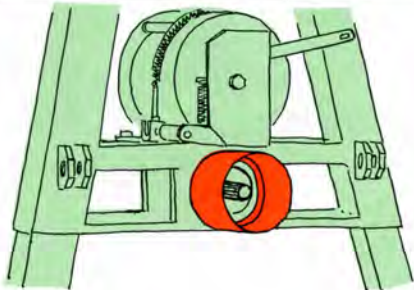

Keep all PTO shields in place.

The power intake shaft should have splines. Avoid threaded shafts because they are difficult to disconnect.

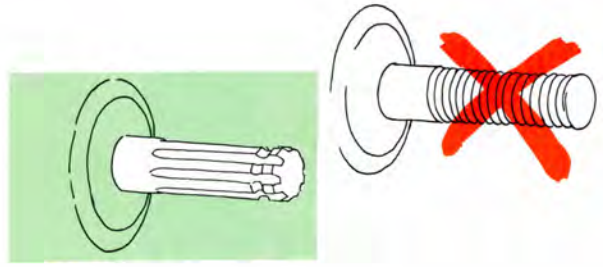

Read the manufacturer's manual before adjusting the clutch and brake.

All blocks and the cable drum should be equipped with hand protection devices.

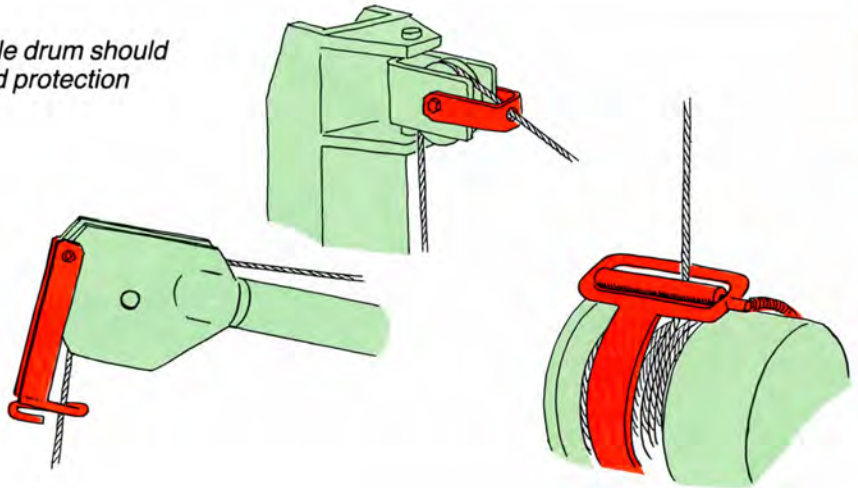

The crane boom will have adjustment holes roughly 20 to 30 cm apart.

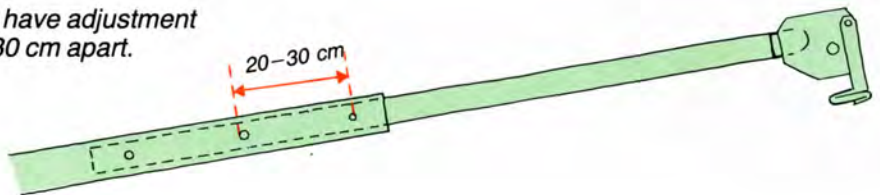

The cable should be at least 8 mm in diameter and 40 m long.

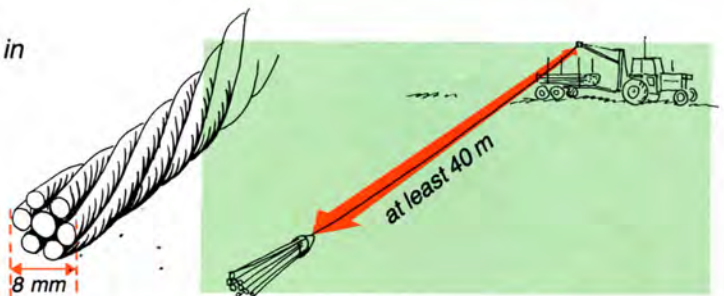

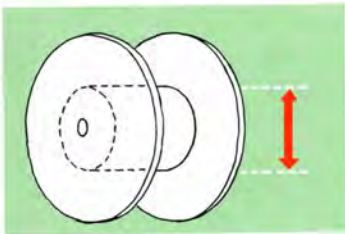

The drum diameter should be at least 10 times greater than the cable diameter.

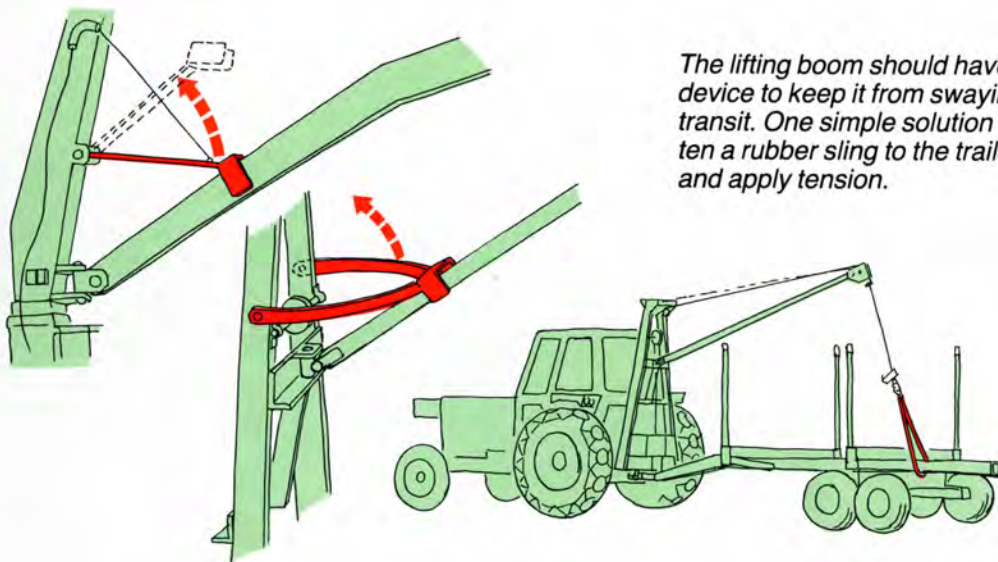

The lifting boom should have a lock device to keep it from swaying in transit. One simple solution is to fasten a rubber sling to the trailer frame and apply tension.

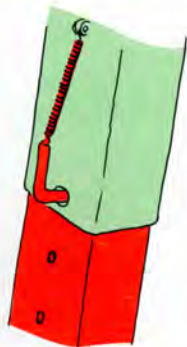
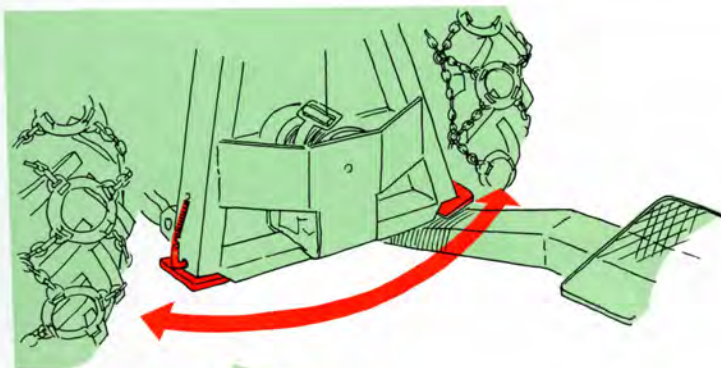

The adjustable support legs on the crane should have springloaded lock pins which cannot shake loose. The legs should not extend below the crane frame when locked in the "up" position to allow free movement of the trailer drawbar.

Mounting the crane and attaching the trailer

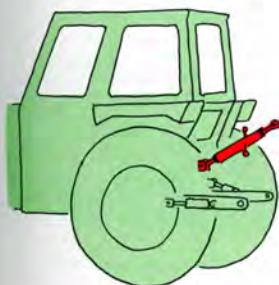

1. Attach the top link of the three-point hitch.

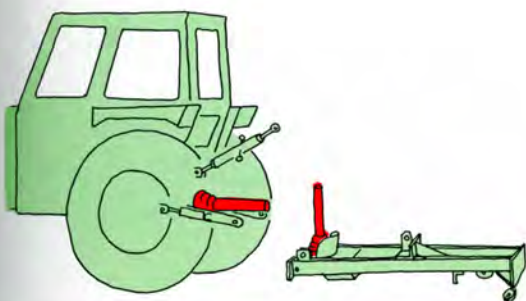

2. Attach half the PTO shaft to the tractor and half to the crane. If there are two PTO connections on the tractor, use the one set to turn at 540 revolutions per minute.

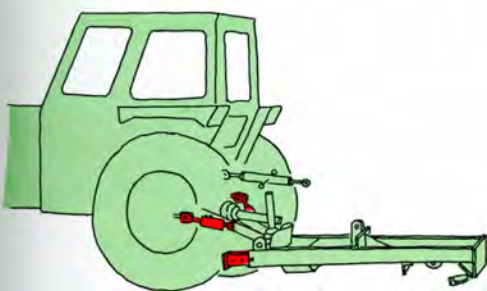

3. Lower the crane support legs 20 cm. Remove lifting boom and place the crane frame on the ground. Attach the two lower links of the hitch. Extend the sway bars if necessary.

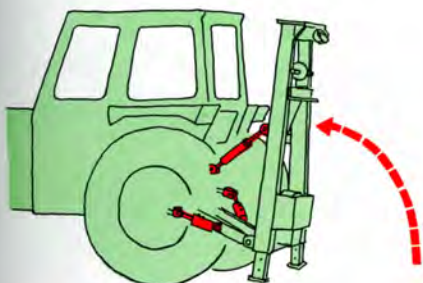

4. Tip the crane up and attach the top link of the hitch. Shorten the sway bars so that the crane will not swing sideways.

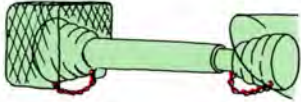
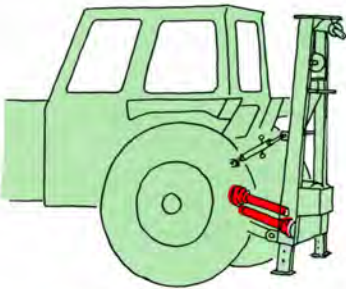

5. Check that the PTO shaft is the proper length even with the crane in the raised position on the hitch. If the shaft is too long, cut it and its protective cover to the proper length. Remove the part of the shaft attached to the tractor. Connect the two halves of the shaft and re-attach the tractor end. Attach the pipe-shaped shields so that they will not rotate.

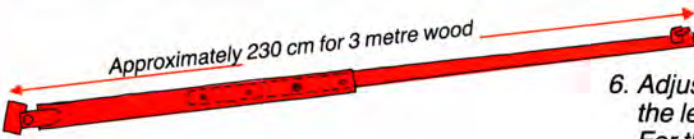

6. Adjust the lifting boom according to the length of wood to be loaded. For three metre wood, a boom length of about 230 cm is recommended. For saw logs, 280 cm would be about right.

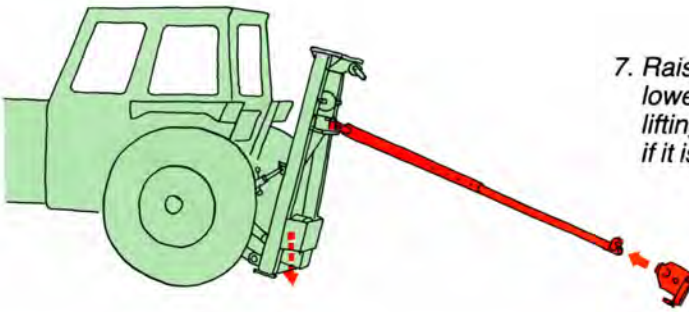

7. Raise the crane support legs and lower the crane frame. Attach the lifting boom and outer snatch block if it is removable.

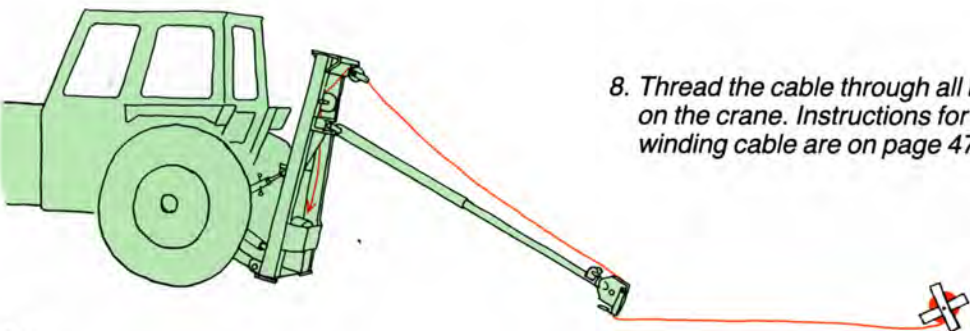

8. Thread the cable through all blocks on the crane. Instructions for un-winding cable are on page 47.

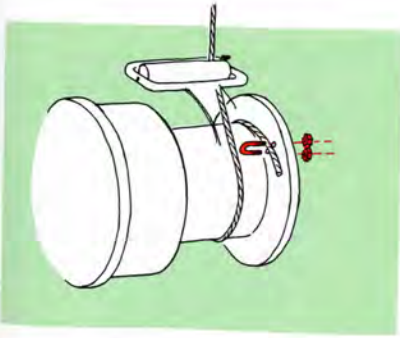

9. Attach the cable to the cable drum according to manufacturer's instructions.

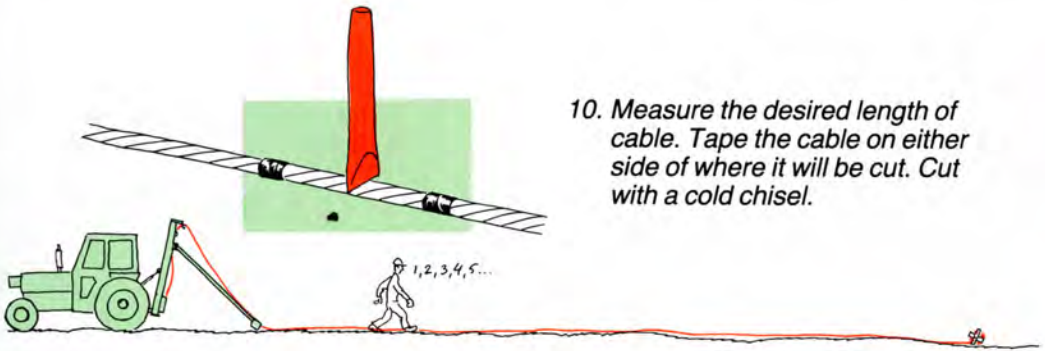

10. Measure the desired length of cable. Tape the cable on either side of where it will be cut. Cut with a cold chisel.

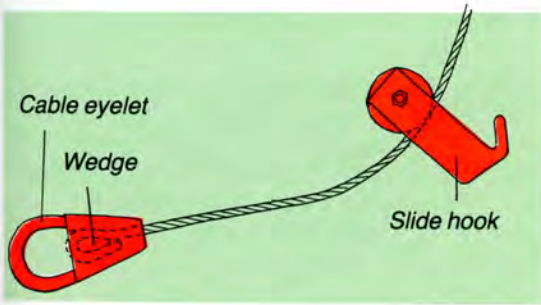

11. Attach the slide hook and cable eyelet as shown on page 48.

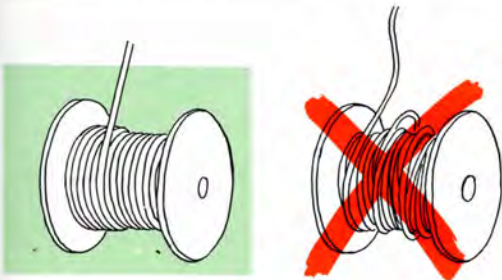

12. Wind the cable onto the cable drum, making sure the cable is evenly distributed as it rolls in. A load on the cable helps maintain even tension.



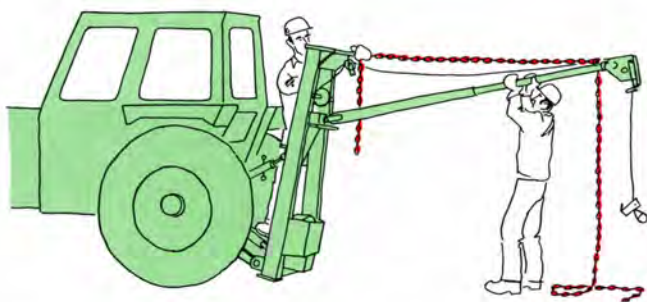

13. Attach and tension the lifting boom stabilizer chains either lifting the boom by hand or by using the winch.

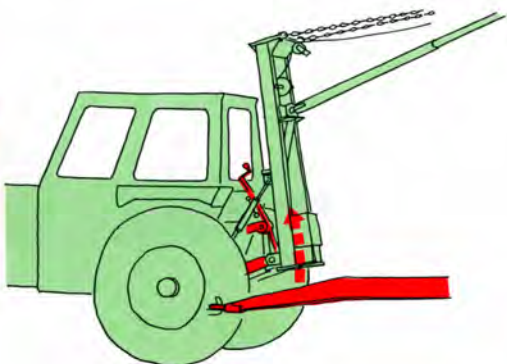

14. Use a crank to adjust the lower links to level the crane frame. Raise the crane so that the trailer can be attached to the drawbar.

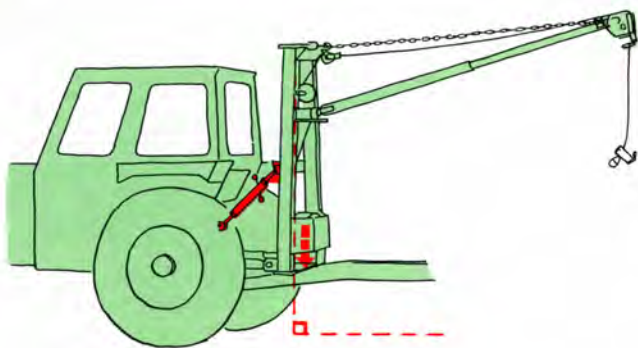

15. Lower the crane until it touches the trailer central beam (loading position). Adjust the top link of the hitch so that the crane is vertical. Check that the top link is not worn. Lock the top link.

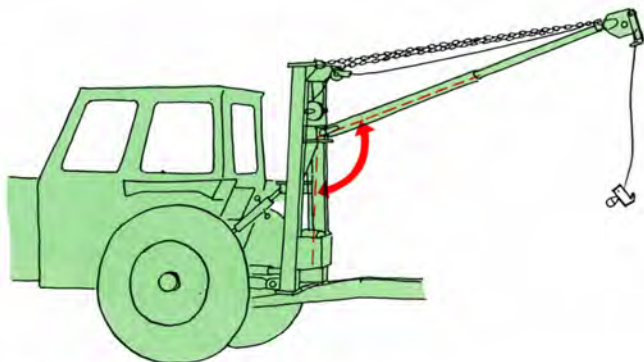

16. Adjust the boom angle using the stabilizer chains. A boom angle of about 110 degrees is best for loading.

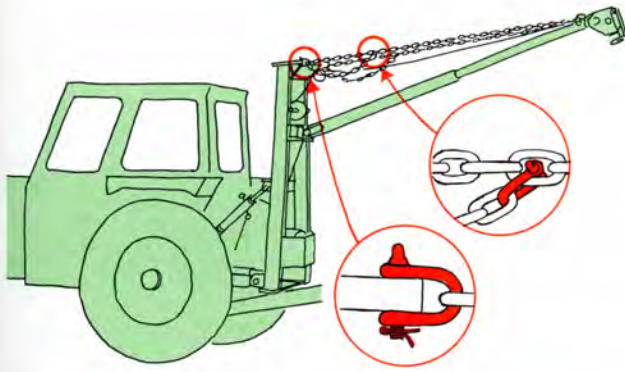

17. Secure any surplus chain with shackles. Use cotter pins to lock the shackles holding the stabilizer chains.

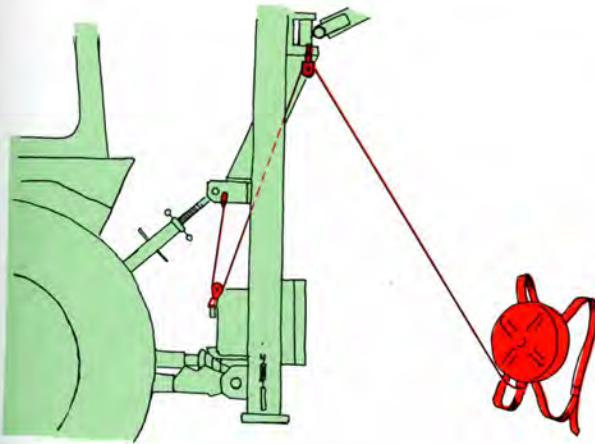

18. Adjust the winch according to manufacturer's instructions and mount remote control line. A two snatch-block arrangement will increase leverage and make control easier.

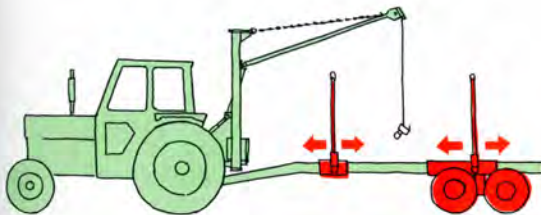

19. Adjust the bunks on the trailer and fasten them in place. The end of the lifting boom should be directly above the mid-point of the load.

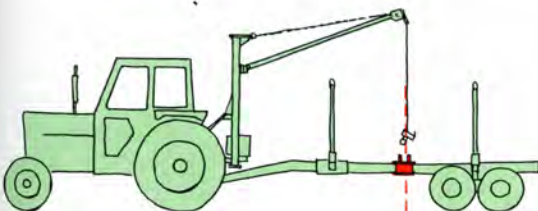

20. If you are going to use a dump beam, it should be connected to the trailer centre beam right below the end of the lifting boom.

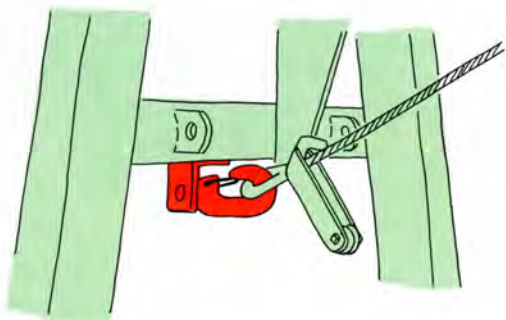

21. When the crane is not in use, secure the end of the cable to the crane frame with a safety snap-hook.

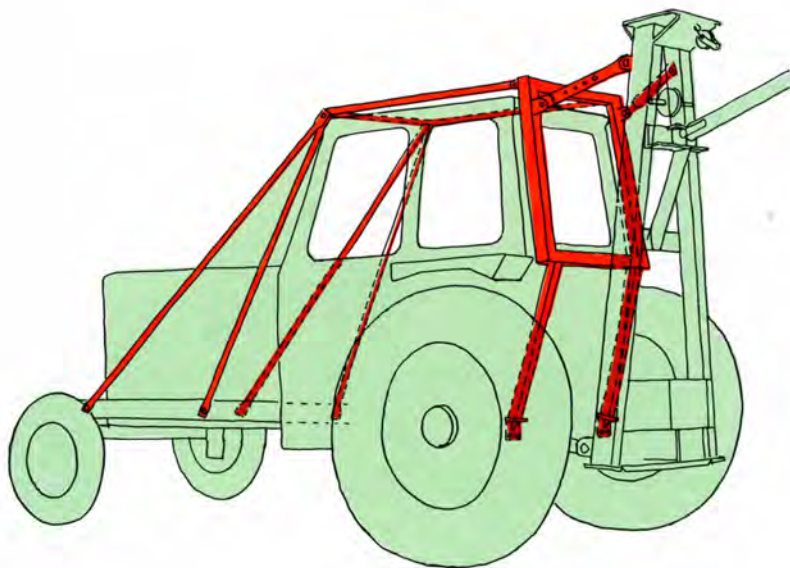

22. If the crane is to remain on the tractor for a long time, it should be attached to a special frame by two articulated bars instead of to the top link of the three-point hitch. This provides four attachment points and makes the crane more stable. The top link of the hitch would only be used when connecting or disconnecting the crane unit. The special frame must not be attached to the tractor cab. Remember welding on the tractor cab and safety frame is unsafe.

Grapple loaders

A grapple loader on a farm tractor is not a good solution from ergonomical point of view. The operator would be forced to sit in a twisted position or stand on his knees on the seat when operating the loader. Such positions could affect the operator's back and joints if long time periods are involved.

The grapple loader cannot be used to winch wood from the stump to a trail during a thinning operation. A separate winch unit would have to be purchased for this.

A grapple loader-equipped farm tractor does not have the capabilities of specially designed forestry forwarders. Stability is limited in off-road situations and the grapple reach is seldom more than five metres. The grapple loader will probably require a special hydraulic pump and tank if the unit is mounted on a farm tractor.

A grapple loader is expensive and a large amount of work would have to be done to justify purchasing such equipment.

If a grapple loader is suited to your needs, there are two types to consider:



Tractor mounted grapple loader

Advantages:

This type of unit can reach wood in front of the tractor. The tractor can be easily disconnected from the trailer. Stability is better in early stages of loading and the vehicle combination is short.

Disadvantages:

The grapple must be hooked to the front of the tractor during transport. If the grapple is hooked to the load on the trailer it can be twisted and damaged when turning unless it has a so-called "flotation" position. A swinging grapple can damage residual trees.

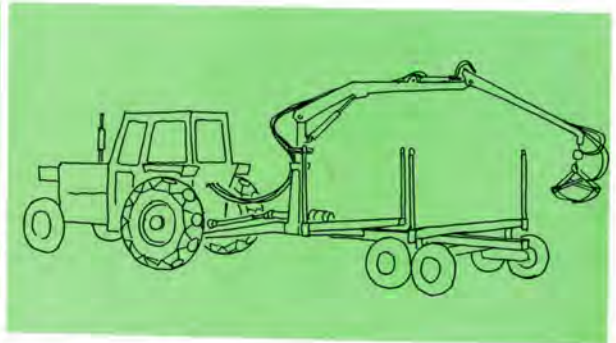

Trailer mounted grapple loader

Advantages:

In transport position the grapple can be hooked right to the load and is not affected by turning actions. Disconnecting the trailer also disconnects the grapple from the tractor.

Disadvantages:

This grapple will not reach wood in front of the tractor and has limited stability until there is some wood on the trailer. The vehicle combination is long and the hydraulic connections between the tractor and trailer are more exposed to damage.

Accessories

Control equipment:

Remote control line

A nylon line extended along the skid trail will allow remote control of the winch or the crane.

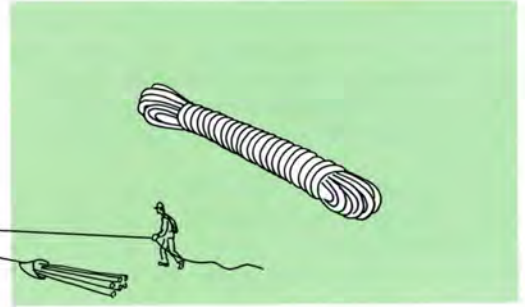

Line caddy

This unit automatically winds or unwinds the control line as the operator follows the load. It holds about 45 metres of line.

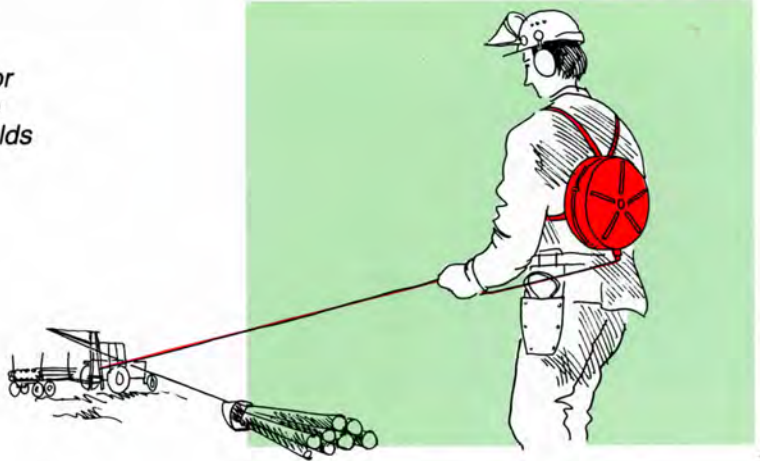

Radio

Radio control eliminates the need for control lines. Single channel radio units for controlling mechanical winches are relatively inexpensive. Make sure the control unit will stop the winch without any delay. For safety reasons radio controls should not be used when loading or unloading with a crane.



Skidding and loading

Eyelet and slide hook

An eyelet on the end of the cable is easy to push under a bundle of pulpwood. The eyelet hooks into a slide hook which is designed to minimize cable wear. The hook releases automatically when tension is removed from the cable. If you use skid tongs, attach them to the eyelet with a screw shackle.

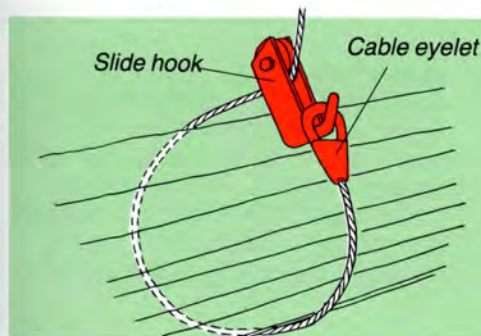

A slide hook of pipe

This type of hook does not slide as easily along the cable. This makes it slower to work with.

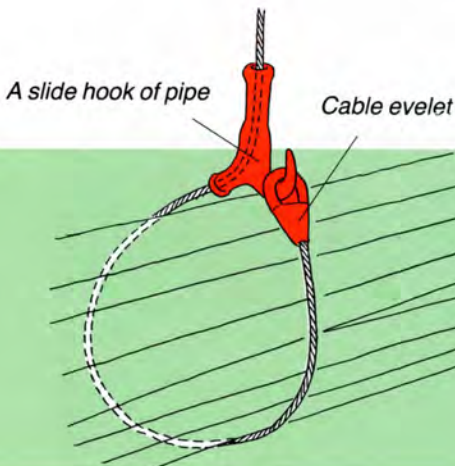

Bundle hook

A sturdy metal hook helps pull the cable under a bundle of wood. You can easily make this type of hook yourself.



Skid tongs

There are several models of skid tongs which are used for both skidding and loading logs.

Unless you have a remote controlled winch, use skid tongs with springs so that the tong teeth dig into the wood even when there is no tension on the cable.

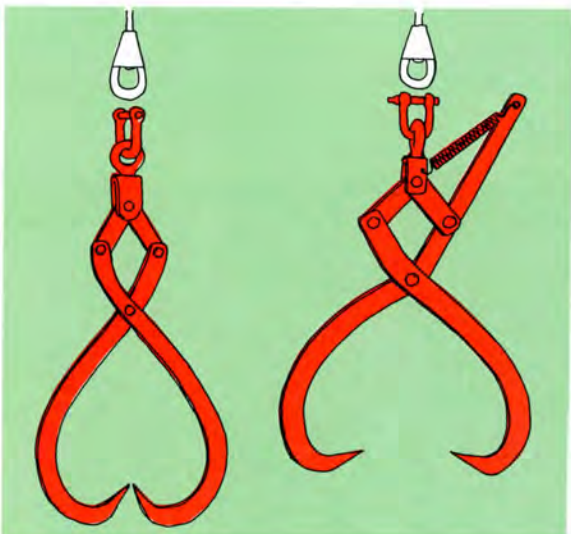

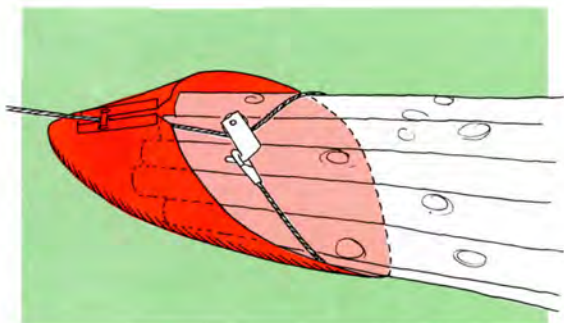

Skid pan

A skid pan can be made out of any light material such as aluminum or fibreglass. A recycled car hood is sometimes suitable. The skid pan makes winching easier and prevents damage to the residual trees and the ground. Skid pans used with cranes should be detachable from the cable (see page 88).

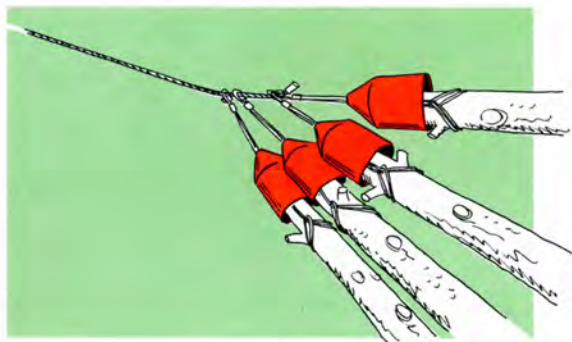

Skid cones

Skid cones are useful for hauling large, de-limbed stems. Several cones can be used together, each attached to the top of a stem to be choked. Sliding blocks on the chokers bring all the cones together for skidding.

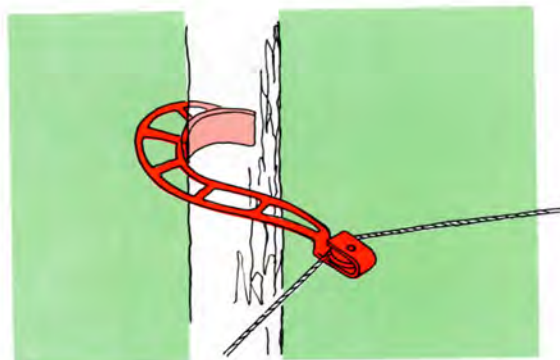

Corner hook

A corner hook can be used to quickly change the hauling direction. **NOTE:** It is not strong enough to be used as a snatch block.

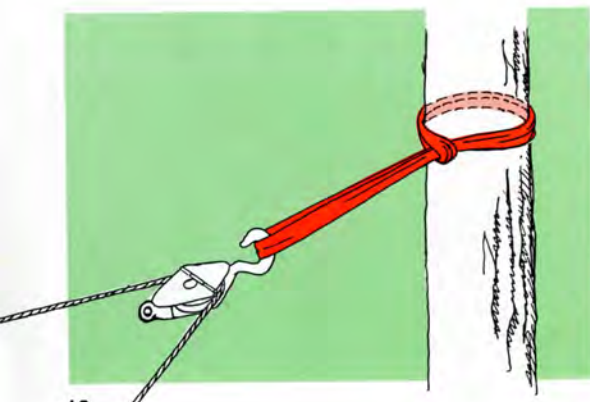

Strap

Several types of straps are available for use with snatch blocks. The most convenient is in the form of a loop which can be attached to any size tree.

Snatch blocks

There are both "open" and "closed" snatch blocks. The cable can be removed from the "open" block without opening the block. (1) A "closed" block must be opened to insert or remove the cable. (2)

Closed blocks with twistable halves (3) open in such a way that the cable cannot get between the wheel and the side wall of the block. Ball-bearings make this type of block easy to open.

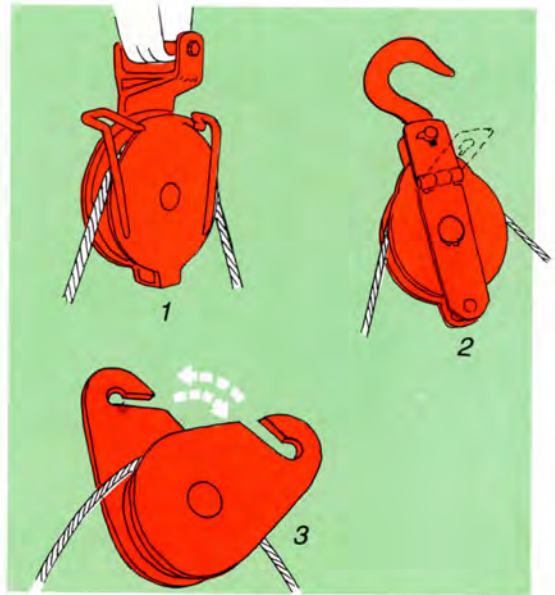

Loading and unloading

Picaroon

A picaroon allows you to stand back while guiding a load. This reduces the risk of injury if the load should slip or fall.

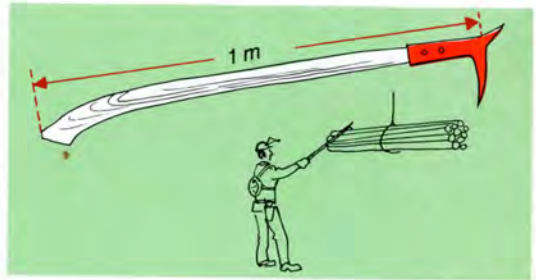

Lifting hooks

Swedish lifting hooks are useful when handling roundwood. (Note: This is not a pulp hook which has the handle perpendicular to the hook).

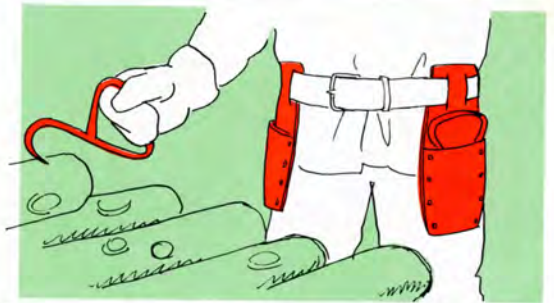

Rope hook

A branch with a hook on it makes a handy tool for catching the cable when loading or unloading with a crane. A hook holder can be made simply by welding a piece of pipe to the crane frame. Drive a nail in the end of the branch and it will serve as a primitive picaroon for guiding a load.

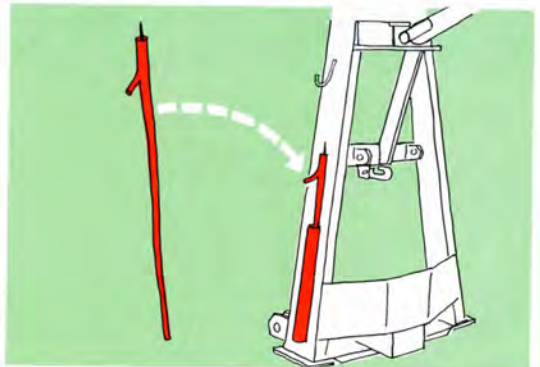

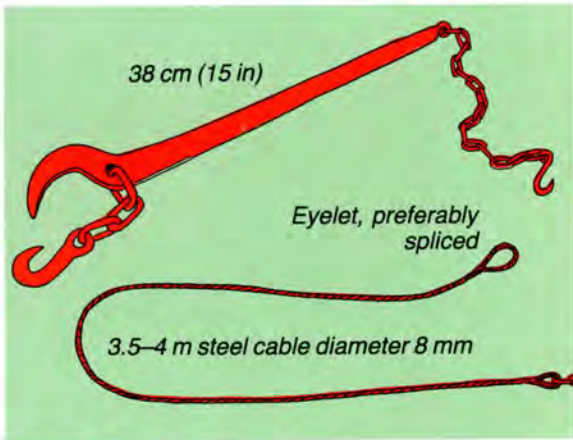

Load straps

If you use a dump beam to unload your trailer you should have one more set of load straps and binders than you have assortments of wood.

If you are forwarding softwood pulp and hardwood pulp, for example, you would need at least three sets of straps and binders (see illustration page 91).

1.5-2 m steel chain diameter 9 mm

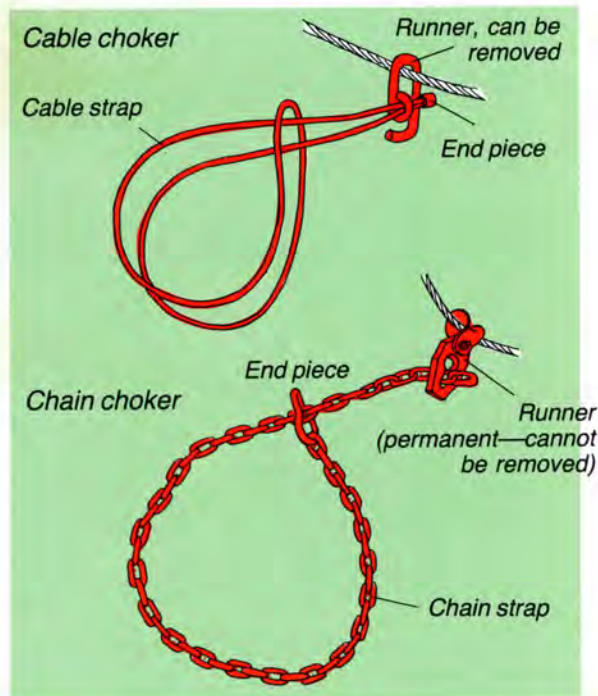

Chokers

A choker is made up of a runner, a strap and an end piece.

Cable chokers are less expensive than chain chokers but wear out more quickly. Cable tends to twist and create sharp wire ends that could injure the operator. Safety mittens with reinforced palms are recommended when using cable chokers.

Chain chokers are recommended for rocky or bare ground conditions or any time large stems are being winched. Chain chokers are heavy but only a few are needed when winching large logs. They are easy to lose in underbrush so paint them a bright color.

The choker cable or chain should be of smaller diameter than the main winch cable. If the load is too heavy, the choker will break protecting the more expensive winch cable.

Dump beams

It is easy to make a dump beam for unloading a trailer (see page 90).

Parts include:

Metal plates 8–10 mm thick over and under the trailer centre beam bolted together as illustrated.

Guide rails The two parallel rails for the dump beam are welded on the upper plate perpendicular to the trailer beam. The guide rails should be about 40 cm long with holes in the bottom corners for a steel pin.

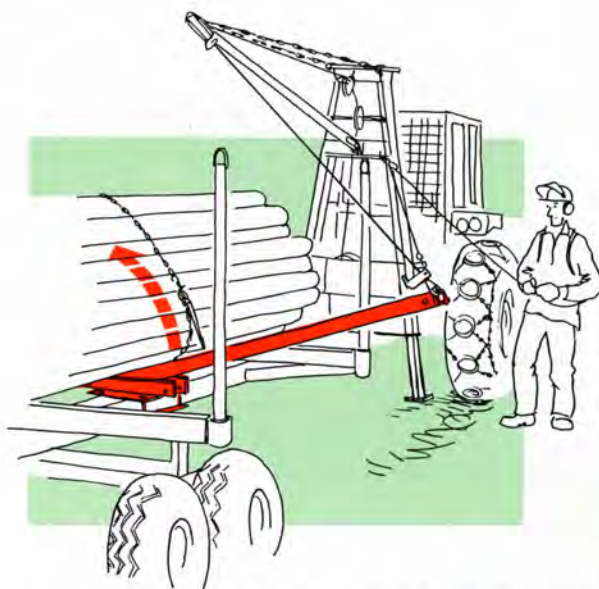

Shackle to attach cable during dumping

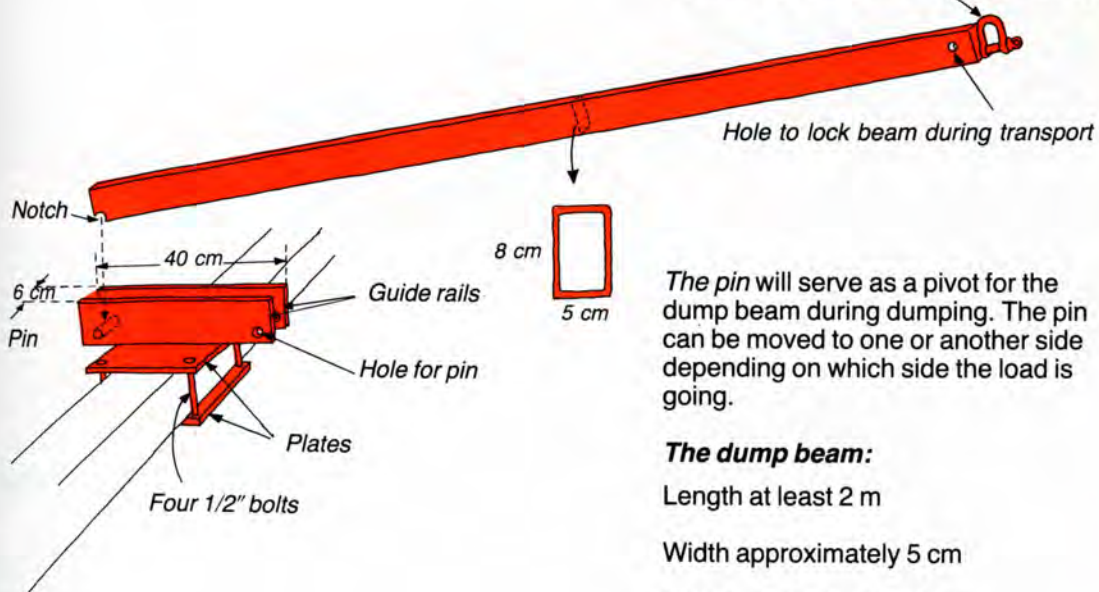

The pin will serve as a pivot for the dump beam during dumping. The pin can be moved to one or another side depending on which side the load is going.

The dump beam:

Length at least 2 m

Width approximately 5 cm

Height approximately 8 cm

Material 5 mm sheet metal

The lower side of the dump beam should have a notch designed to catch the pin in the guide rails and hold during unloading. The opposite end should have a shackle for attaching the crane cable. The dump beam should be designed to be stored inside the centre beam of the trailer during transport.

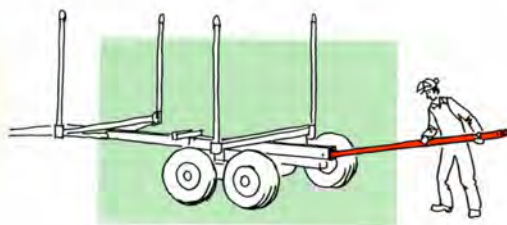

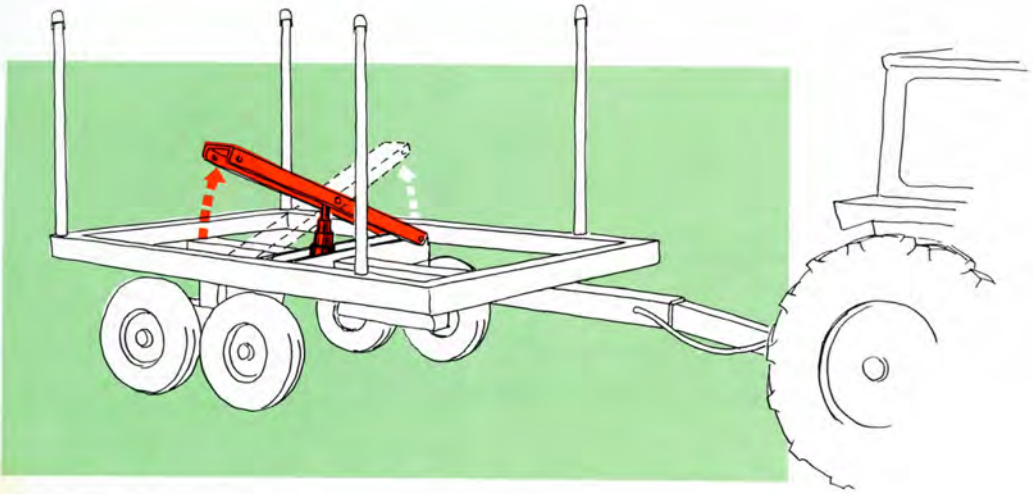

Hydraulic dump beam

The hydraulic dump beam is attached to the tractor hydraulic system. It can tip in two directions, depending on which end of the beam is bolted to the trailer frame.

A trailer with a hydraulic dump beam is expensive.

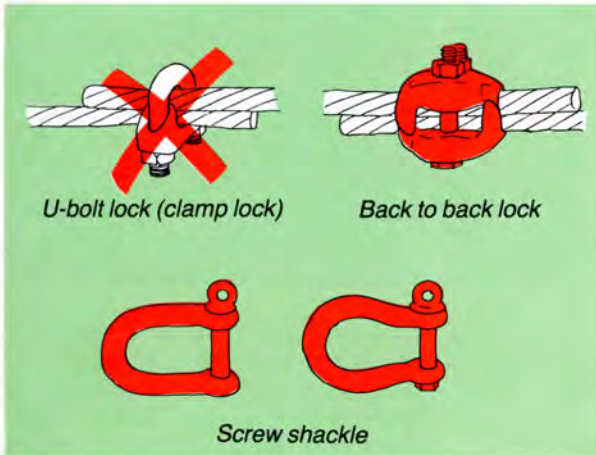

U-bolt lock (clamp lock)

Back to back lock

Screw shackle

Cable locks and screw shackles

Back to back locks and screw shackles are handy to have in the tool box. Back to back locks can be used to mend a broken cable. Shackles can repair things like broken tire chains. The U-bolt lock (top left) can damage cable and should not be used.

Chains

A 5–10 metre chain is helpful if the tractor gets stuck and needs a tow. (See towing and salvage on page 65.)



Tire chains

Tire chains substantially increase traction in off-road conditions. Tire chains with studs are recommended. Some jurisdictions restrict use of chains on public highways due to the potential damage to the road surface.

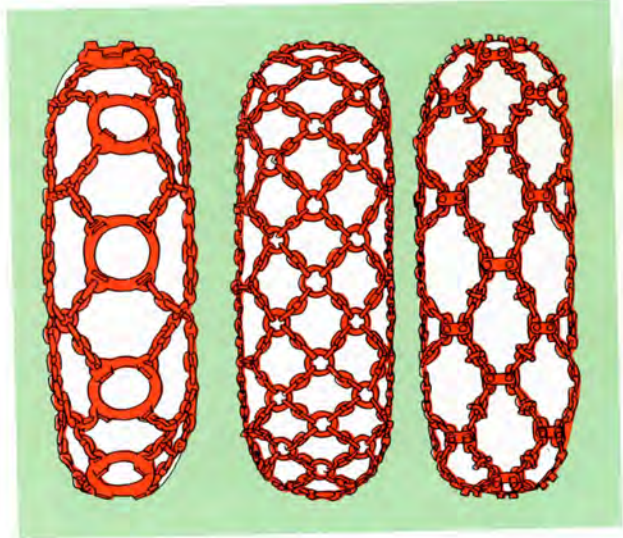

Tire chains can be difficult to install and tighten. Try the following technique.

Place the chains behind the wheel with the inside down and the locks forward. Loop a piece of wire over the top of the tire and attach it to the chain locks. Drive slowly forward until the chains are in place. Fasten the locks and remove the loop of wire. Fasten any loose pieces of chain with screw shackles.

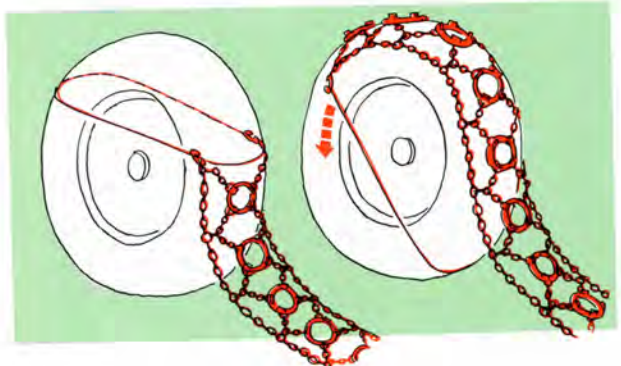

7 wire core

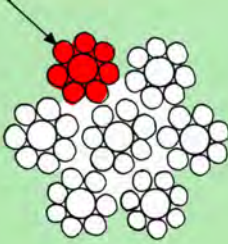

6 core cable with centre core. The centre core in this case has the same composition as the outer cores.



Ordinary right hand lay cable



Right hand Lang's lay cable

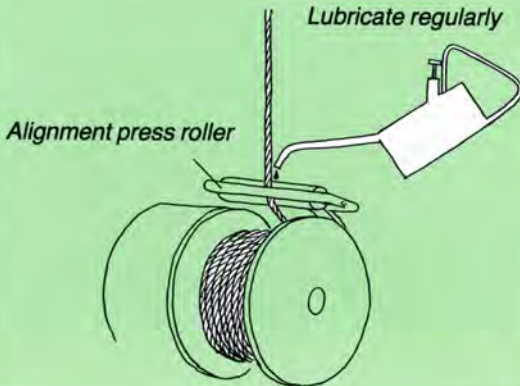

Cables

A cable can perform many jobs. It can pull or skid a load or lift the load onto a trailer. There are many types of cable for many different uses. This book deals only with types suited for winch and crane operations.

A cable is made up of a number of cores which in turn are made up of steel wires twisted together. The cores are twisted around a central core. For winching, the central core should be steel to provide extra support and prevent the cable from being flattened, bent or deformed under pressure. Steel-cored cable is stronger than hemp-cored cable and also somewhat stiffer.

There are different ways to twist the cores. If the cable is twisted the same way as the wires in the individual cores it is called a "Lang's lay".

If the cable is twisted the opposite way to the wires in the individual cores, it is called an "ordinary lay".

Ordinary lay is recommended for winching because it is less likely to twist under stress and has better resistance to exterior wear.

The more individual wires there are in the cable, the greater the flexibility. A 222 wire cable with a steel core should be just as flexible as a 144 wire cable with a hemp core.

Lubricants

Lubricate the cable regularly with oil (chainsaw oil for example) to reduce friction and rust damage.

When a cable is working it is constantly exposed to bending, stretching and squeezing. This makes the cores move in relation to each other as well as movement within the cores. This creates friction and inside wear. To reduce this wear the centre core is saturated with a lubricant during the manufacturing process. A lubrication effect can also be obtained by coating the individual wires with zinc. This process is expensive and reduces (somewhat) the strength of the cable.

All cables will wear out eventually. If they are improperly mounted, they will wear more rapidly and the winch owner will face substantial replacement costs more often than necessary.

Use proper techniques when winding or unwinding a cable.



Proper unwinding using a capstan



Right

Wrong

Avoid twists or other similar stress of the cable. The diameter of the cable drum or of the disc in a snatch block should not be less than 20 times the cable diameter.



The cable drum should have an alignment device or a pressure roller which will evenly wind up the cable on the drum without crossing over.

There is less wear of the cable end if a slide hook-eyelet combination is used instead of a hook on the cable.

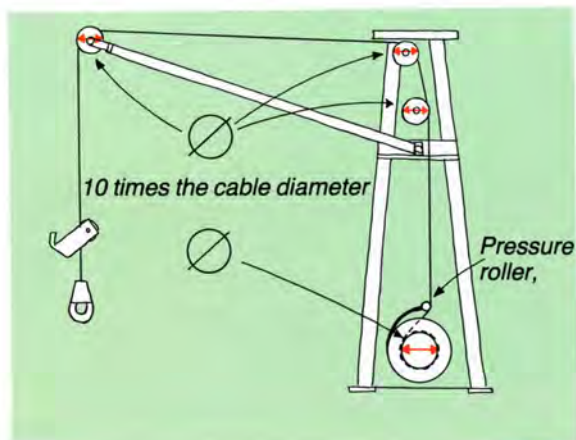

Mounting of slide hook and cable eyelet

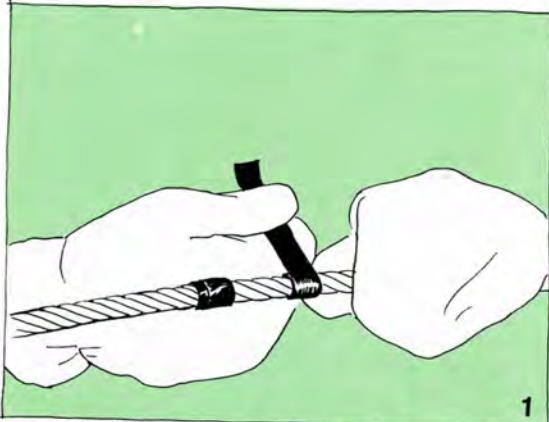

Tape the cable before cutting to keep cores in place.

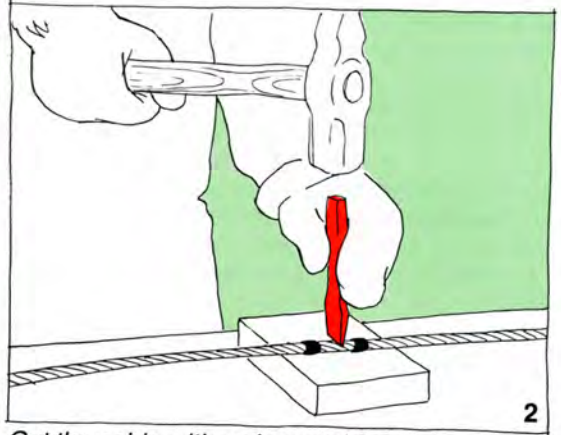

Cut the cable with a sharp cold chisel.

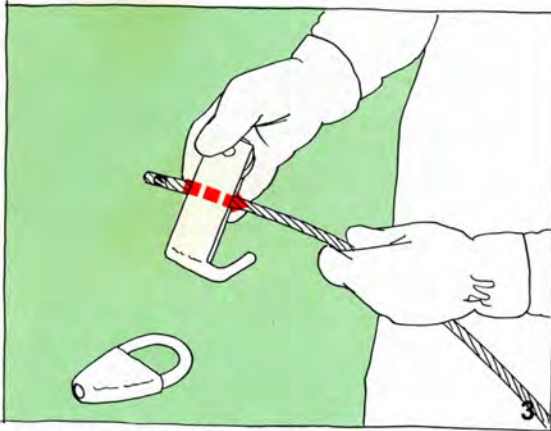

Mount the slide hook with the hook facing the cable.

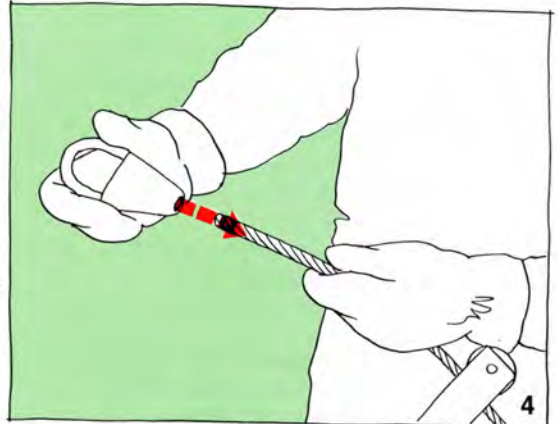

Mount the cable eyelet.

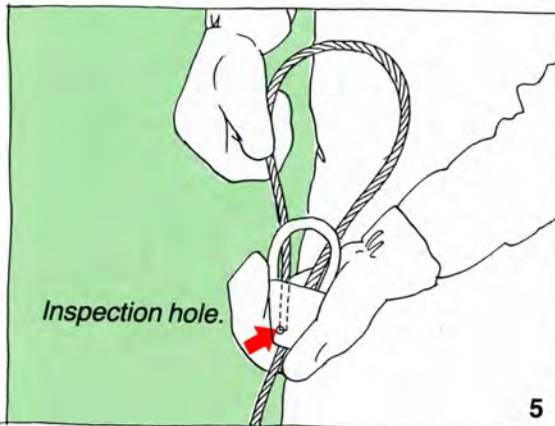

Insert the taped end until you can see it in the hole.

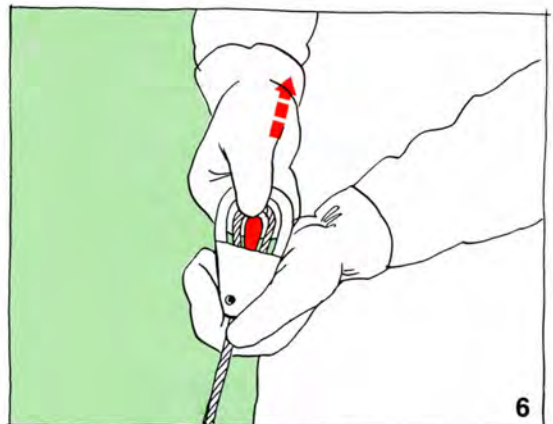

Insert the wedge and pull the cable. Use the winch to further pull the wedge into place.

If you are using another type of hook the cable eyelet must have an eye ring as protection and be fastened with at least three back to back locks.

A back to back lock has two bolts with nuts and two jaws with a recess for the cable.

The distance between the locks should be at least three times the cable diameter.

So called U-bolt locks are not recommended if the wood will be lifted from the ground.

The U-bolt lock can damage the cable if it is tightened too much.

A crane cable must be at least 8 mm in diameter. Make sure you get enough cable when you purchase a winch or a crane. The cable should be at least 45 metres long.

A damaged cable should be replaced or repaired immediately.

The cable must be securely fastened to the cable drum. A number of methods are available. A hole in the drum sidewall and a knot, lock screw or a U-bolt lock can be used.

Always use safety mittens when you work with cables

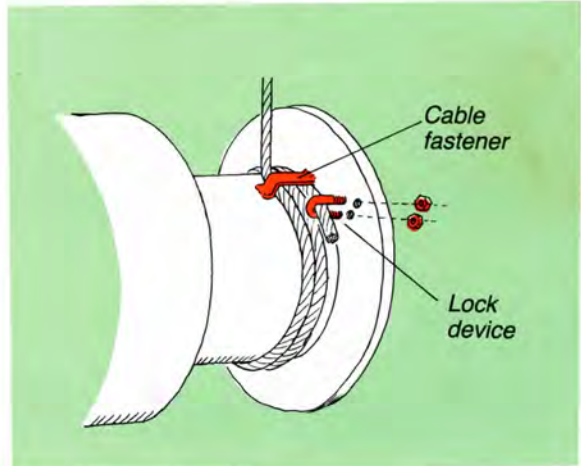
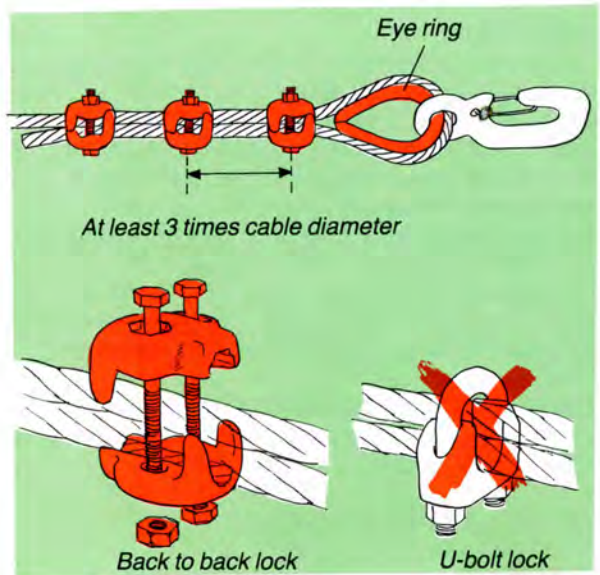

Splicing

Cable breaks do occur and the cable has to be spliced or discarded. Splicing is not difficult, but it is difficult to explain in words. Good splicing requires some training to do successfully. Use a cable with a steel core when you are training because the steel core provides more stability. There are long splices and short splices. A long splice should be approximately 1,000 times the diameter of the cable.

For example, if the cable diameter is 8 mm, a long splice would cover 8 metres of cable. You can make a shorter splice if the cable is not used for lifting or carrying.

The most common cables have 6 or 8 cores plus a centre core. The following instructions tell how to make a long and a short (eyelet) splice on a 6 core cable.

You will need the following tools:

A hammer and anvil
Cold chisel
Screw driver

Start by removing all damaged cable. Make sure that the cores do not open up. Use tape to hold the cores together.

Long splice

1. *Open up (separate) the cable in two halves with three cores in one half and three cores plus centre core in the other half.*

Open up at least 1 metre at each end of the cable.

2. *Move the four cable halves into each other. Place a half with three cores (a) next to a half with three cores plus centre core (c).*

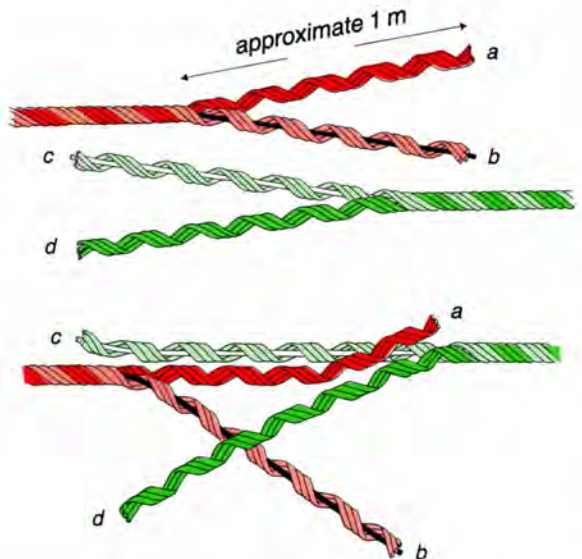

3. Fit and twist the halves together. Unwind (b) and twist (c) into the available space. Do the same with (d) and (a). Leave approximately 30 cm of (a) and (c).

On one side, (b) and (c), you have wire halves with centre cores and on the other side, (a) and (d), you have wire halves with only cores. Cut (b) and (d) so that they are approximately 30 cm long.

4. Start with the side which has only cores. Divide the 30 cm long wire halves so that each core is separate. Make sure that the cores are parallel where the halves meet.

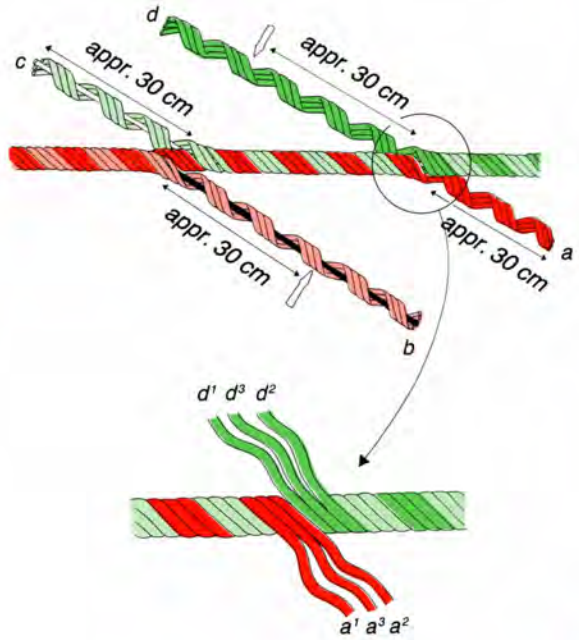

5. Twist one core in each direction. Unwind core a¹ to the left and twist core d¹ to the left into the empty core space. Continue until 5 cm remains.

Then unwind core d² to the right and twist in core a² to the right in the empty core space. Continue until only 5 cm remains.

Cores a³d³ will be lying side by side.

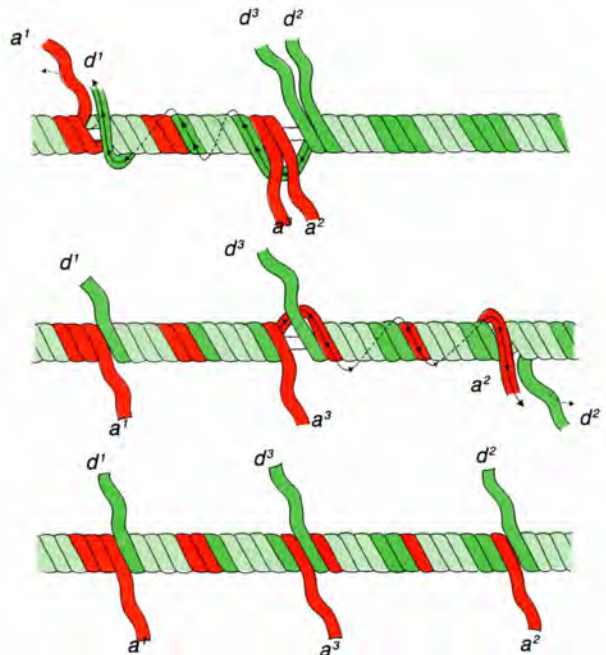

6. Make a knot on the cores. Insert the left core (a^3) over and under the right core (d^3).

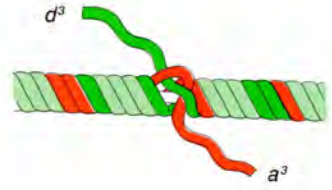

7. Lock the cores. Place the screw driver under the two cores where the core to be locked comes up. Push the core through.

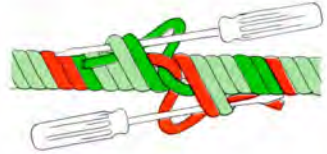

8. Cut off the loose ends.

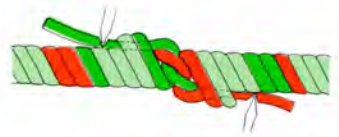

9. Repeat the same procedure for core ends $a^1 d^1$ and $a^2 d^2$.

10. Twist in the centre cores following the same procedure explained under points 4–5. Move the centre cores approximately 6 cm to the right so that the centre cores are separated. Knot and lock the moved cores.

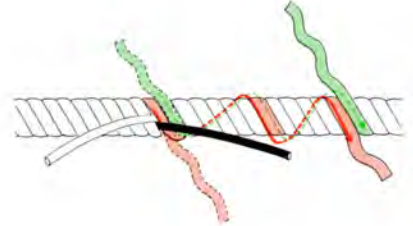

11. Lock the centre cores at least twice.



12. Lock the remaining cores as explained in points 6–8.

Short splice (eye splice)

1. Divide the cable in the same manner as for a long splice.

Put the two halves together and twist them together to create a loop.



2. Separate the individual cores. Make sure they are parallel with each other close to the place where the loop starts.

Cut the centre core leaving a short stump which is inserted in the cable centre.

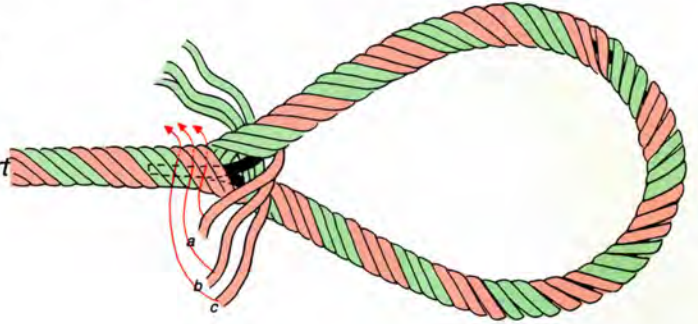

3. Take core (a) and insert it under the closest meeting core. Do the same thing with cores (b) and (c). Turn the loop and proceed the same way with three remaining cores.

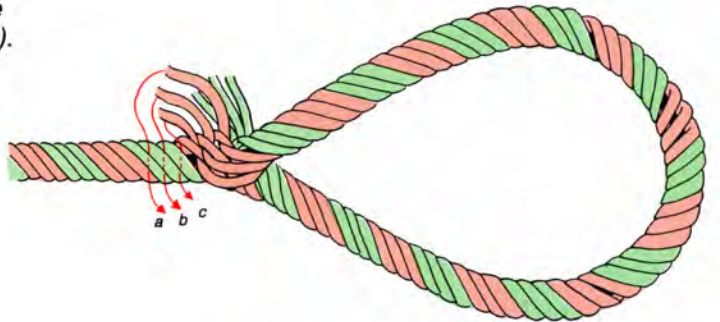

4. Repeat the procedure once or twice.

Cut off the loose core ends as closely to the cable as possible.

Control and maintenance of equipment

Pre-operation checks



Walk around the vehicle and check for leaks.



Check the radiator. Make sure it contains enough anti-freeze or other coolant.



Check oil and lubricate tractor in accordance with manufacturer's instructions.



Make sure that you have enough fuel. Ventilating the fuel system can be cumbersome and cold.



Check tire pressure and tire chains.

Check all lights and reflectors.

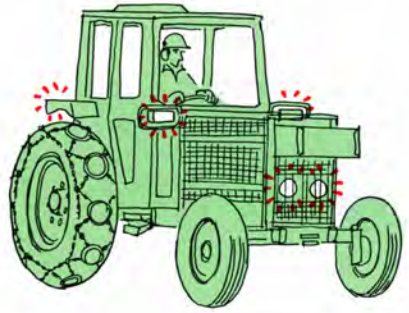

Check the PTO shield—is it intact and well fastened?

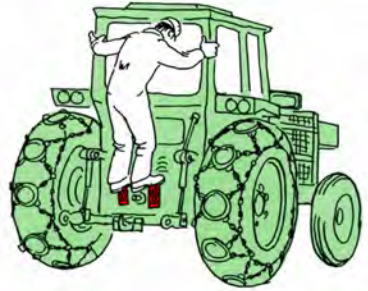

Check the following details on the winch or the crane loader:

1. Are the links tightened so that the winch or the loader will not bounce against the wheels?
2. Is the top link properly locked?
3. Is the cable secured and the cable eyelet wedge well fixed?
4. Is the loading boom fastened?
5. Are the support legs fastened?
6. Is the cable in good condition?
7. Is the cable hook in good condition?

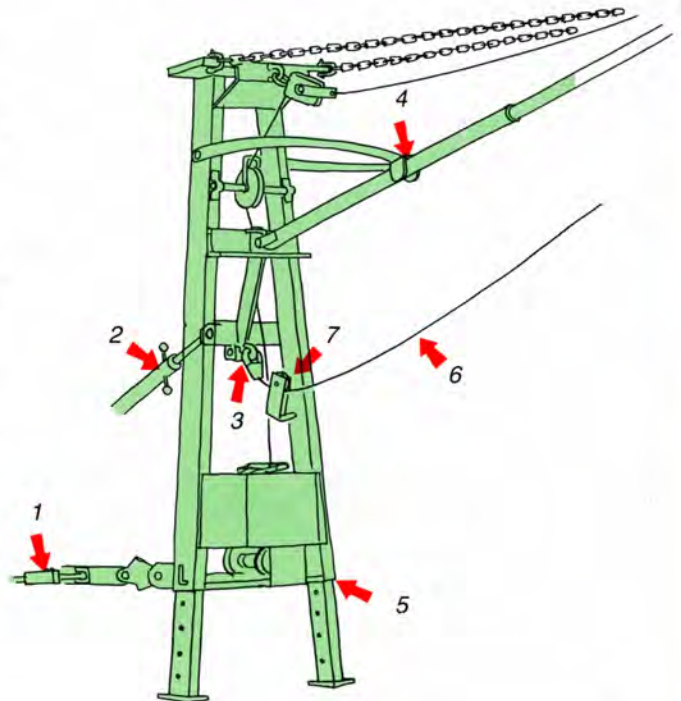

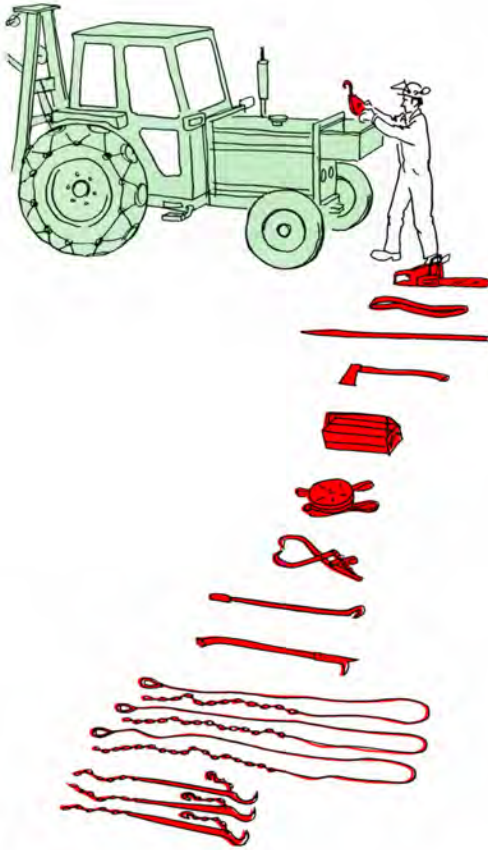

Make sure you have the necessary tools and equipment for a day's work:

Chainsaw

Snatch block strap

Prying bar

Axe

Tool box

Remote control line caddy or remote radio control equipment

Skid tongs

Bundle hook

Picaroon

Load strapping chains and binders (if you use a crane loader and trailer).

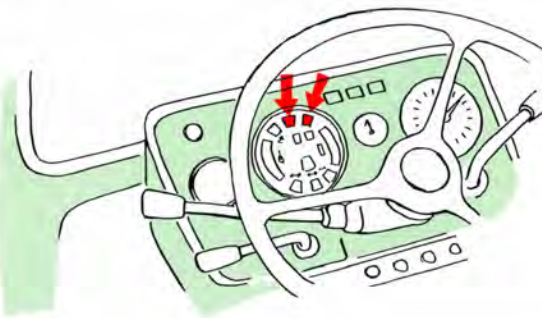

Start the motor, check the oil pressure and make sure the generator is charging.

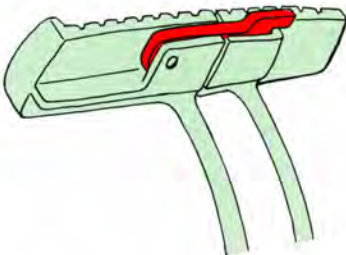

Operation on highway, check the brake pedals to see if they are joined together.

While driving

Check the temperature gauge and other instruments on a regular basis.



Check your rear view mirror regularly to see that nothing has come loose and that you are not obstructing traffic.



NOTE—no passengers—you are responsible.



Tell somebody where you are going and when you plan to come back or make sure somebody knows where you are going and how long you will be away.

After driving or after a day's work

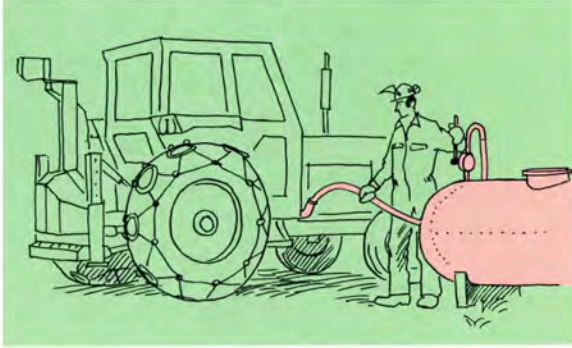

Fill the fuel tank. This will prevent condensation in the tank and water in the fuel. During the winter season add suitable anti-freeze to the fuel, i.e., 1/2 litre denaturated alcohol per 100 litre diesel fuel.

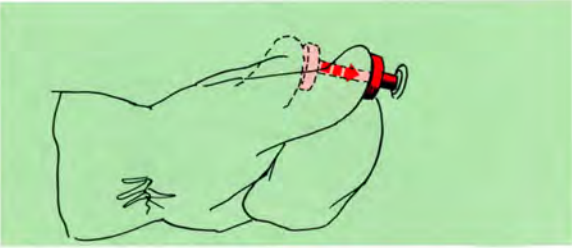

Push the stop button back after the motor has stopped. Sometimes in the winter the stop button will freeze in the pulled out position and prevent starting.

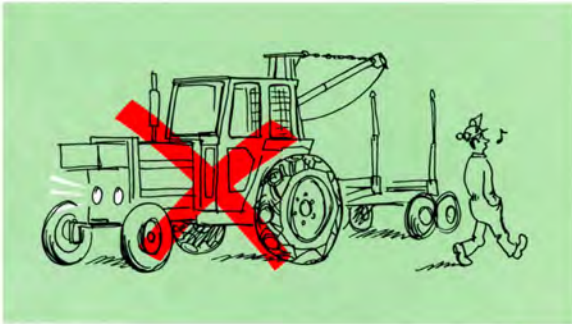

Check all electrical equipment to make sure it is turned off.

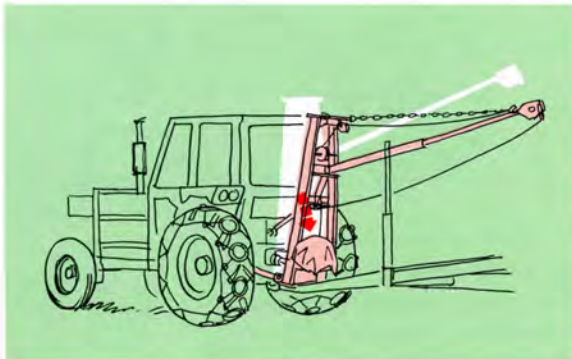

Lower the winch or the wire crane loader.

Cover the winch drum so that rain and snow cannot get in. Humidity can make the brake slip.

Push in the cold weather start button on the injection pump. Leave the revolutions per minute (rpm) control at least the half-way mark. Store the battery at room temperature.

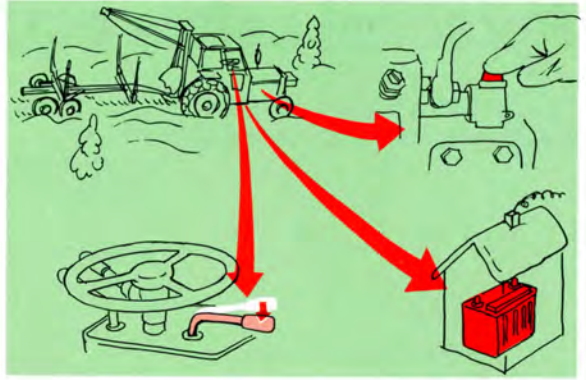

Clean windows, reflectors and head-lights.



Remove the ignition key and lock the tractor.

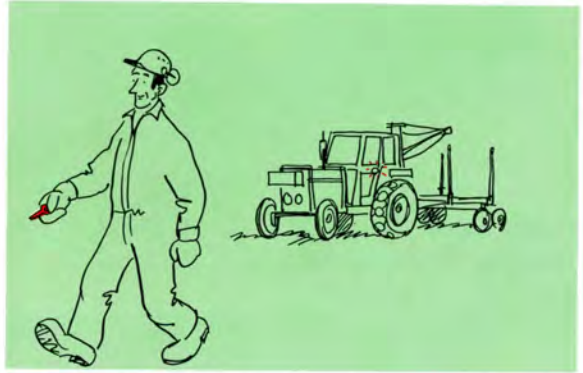

Follow the instructions in the tractor and equipment manuals.



Personal safety equipment

To work with a forestry equipped farm tractor you should have the following safety equipment and clothing:

Hard hat

The hard hat should be well ventilated as you will be using it inside and outside the tractor.

Ear protectors (Ear muffs)

Make sure that your ear protectors guard against chainsaw as well as tractor noises.

First aid

Keep the first aid kit handy so that it can be easily reached by either hand or both hands.

Safety mittens

Safety mittens should protect your hands while working with the winch wire. This type of safety mitten has a double palm.

Safety boots

Safety boots should have steel toes—this will protect the toes.

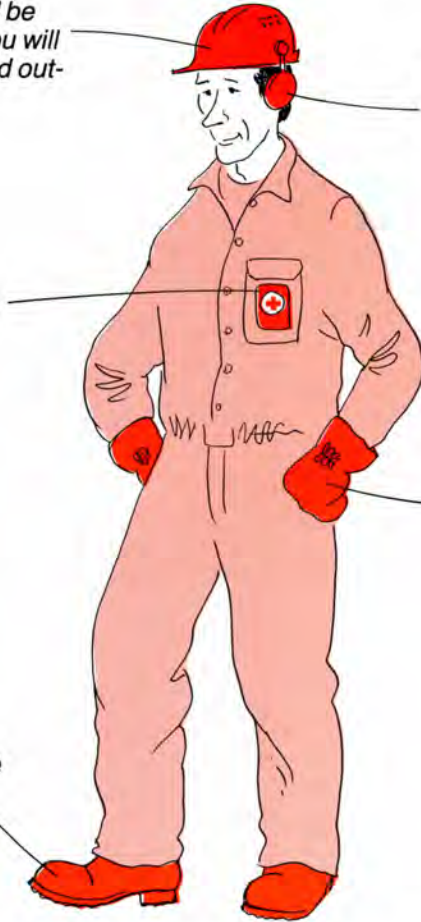

Pants with leg pads.

If you are felling as well as forwarding you should, of course, have a complete set of safety equipment.



Eye protector (visor)



Off-road driving technique

A farm tractor used in forestry is exposed to a harsher work environment than in agriculture. The emphasis is on stability, steering capabilities, ground clearance, driving capabilities, brakes and ability to bounce off obstacles. The drive technique used for a tractor differs substantially from that used in a car. The maximum speed is 30 km/hour. There are more gears and the brakes can be used to brake the vehicle or to turn the vehicle (steering brakes).

The brake pedals should be connected when the tractor is operating on a highway. Steering brakes are used only during off-road driving.



Brake pedals mounted together—normal brakes.



Separate brake pedals—steering brakes.

Use the differential lock only on soft or slippery ground. You should never use the steering brakes together with the differential lock, because you might seriously damage the transmission.

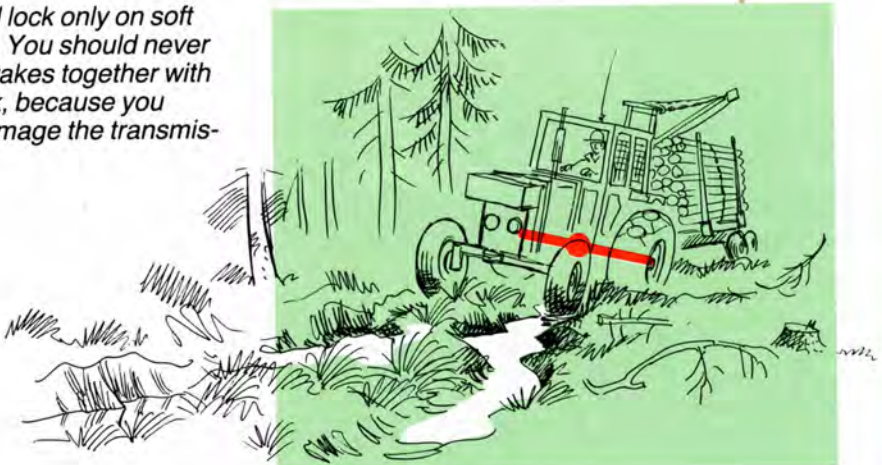

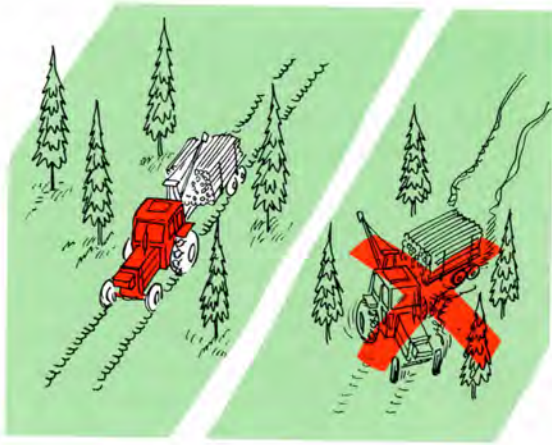

Select a suitable low gear going downhill. This will prevent a jack-knife accident.



Never drive downhill in neutral or with the clutch disengaged.

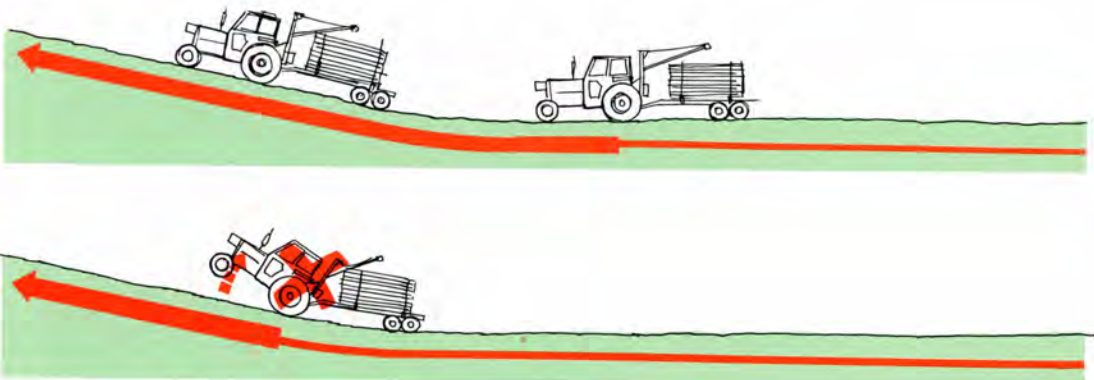

If you drive uphill with a load, select a gear ahead of time and use it the whole way up the hill. Changing gears part way up a hill can be difficult.

The use of front end weights when driving uphill will reduce the risk of raising the front of the tractor (back flip).

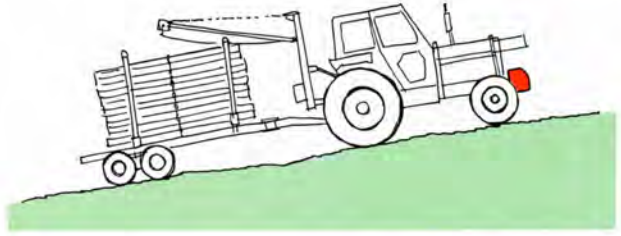

Avoid driving across a slope.



Do not use steering brakes when turning a sharp bend at high speed. The tractor could jack-knife.



Do not rest your foot on the clutch pedal when you are driving. It can create abnormal wear on bearings and clutch plates.



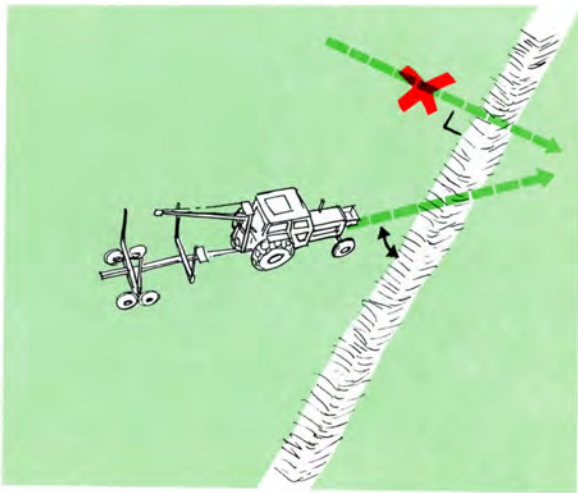

Crossing a small ditch with an empty trailer should be done at a 45° angle to the ditch.

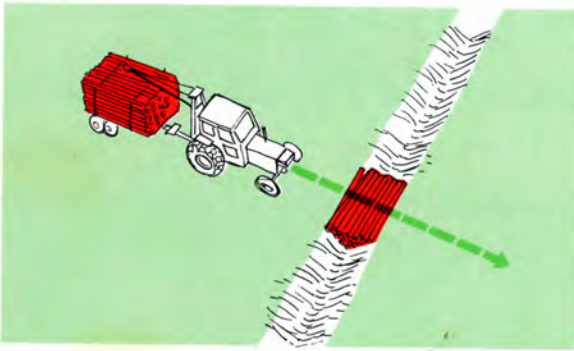

If you have to cross a ditch with a loaded trailer, fill the ditch with wood. Do not forget to remove the wood when you have finished in the area.

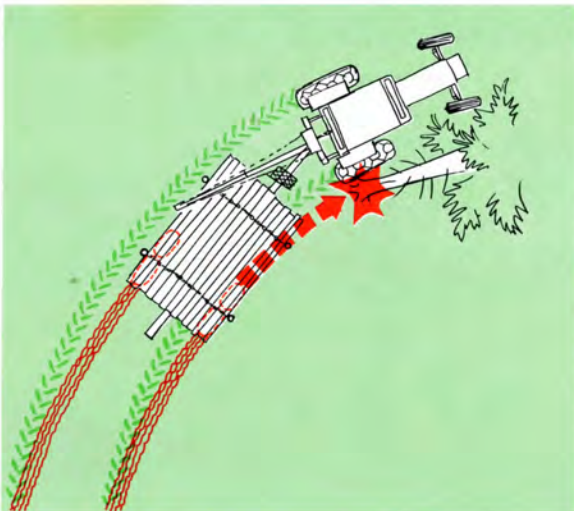

Remember that the trailer will "cut corners".

Towing and salvage

When towing another tractor, speed should be low (not over 20 km/hour). Note the risk of lifting the front of the tractor (back flip).

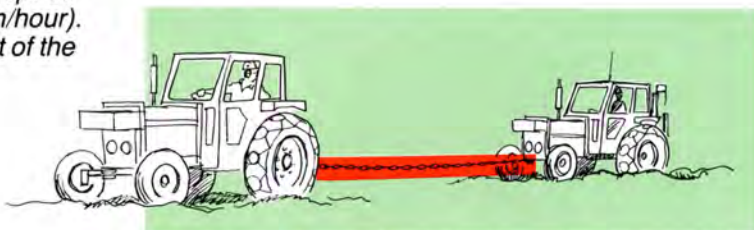

If you have misjudged the soil conditions, the tractor may sink and rest on the belly pan. First try to drive backwards. Place a big pulp stick behind the rear wheels and carefully back until the tractor is on the pulp stick. Place slash and wood under the wheels and in the ruts. Remove the pulp stick. Continue the salvage by backing. Never place a pulp stick in front of the rear tires with the intention to drive forward. The tractor could turn over.

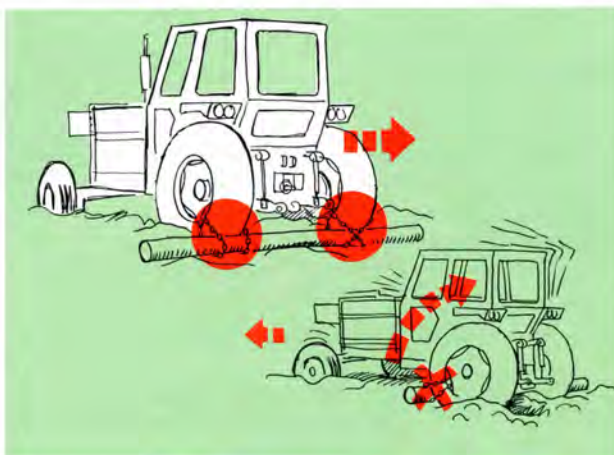

Should you get stuck with a tractor equipped with a winch, you can winch yourself backwards. Use a double cable attached as low as possible. The use of a double cable doubles the pulling force of the winch without increasing the stress on the cable.

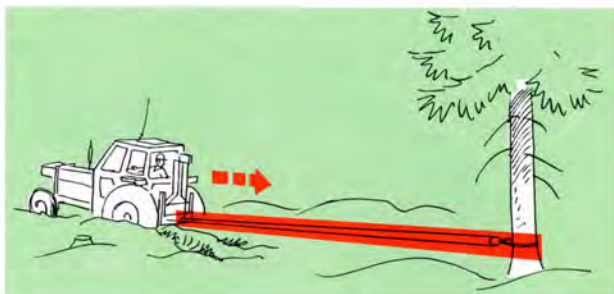

Should you be able to drive forward, you can attach a chain to one of the rear axles. The chain should be placed above the front axle to prevent turning over.

Drive carefully so that you do not damage your rear axle.

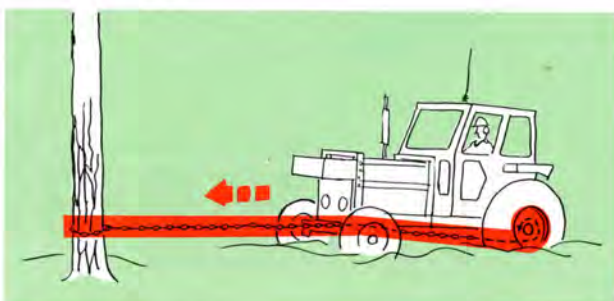

Planning the harvest operation

It is important that you plan your harvesting area ahead of time. With no planning you can easily lose substantial amounts of money.

Management plan

Co-operation between neighbouring landowners can make good economic sense. Maybe there are opportunities to share roads, landings and forwarding equipment.



The forest management plan is a big help. The management plan can help you estimate volume, labour requirements, etc.

Divide your forest into natural logging areas

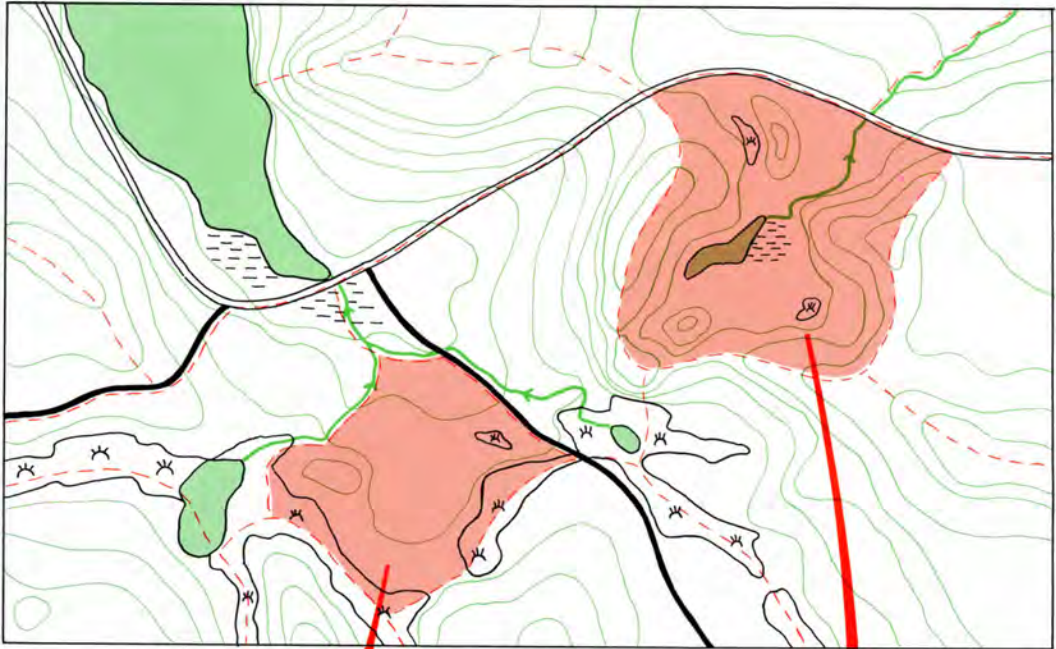

*A logging area is defined by:
Natural logging boundary lines as ridges, hills, swamps and watercourses and available roads.
The woodlot should be divided into winter and summer logging areas. A winter area is an area where the wood is preferably forwarded on frozen ground to avoid soft ground conditions.*



If the terrain is favourable, it is easy to plan a good road network.

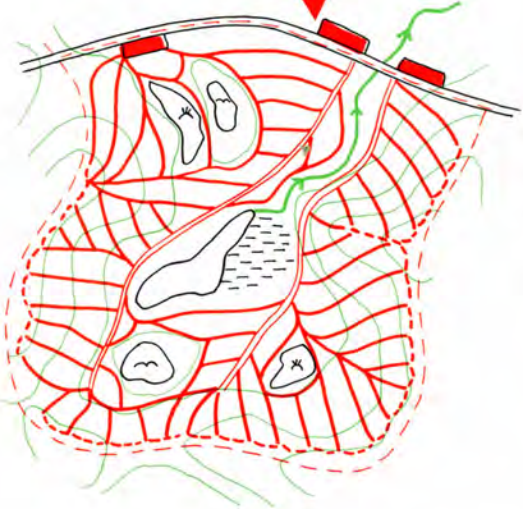

If the terrain is difficult with soft, wet areas, ridges, hills and watercourses, detailed planning is necessary to minimize costs.

Planning the strip road system

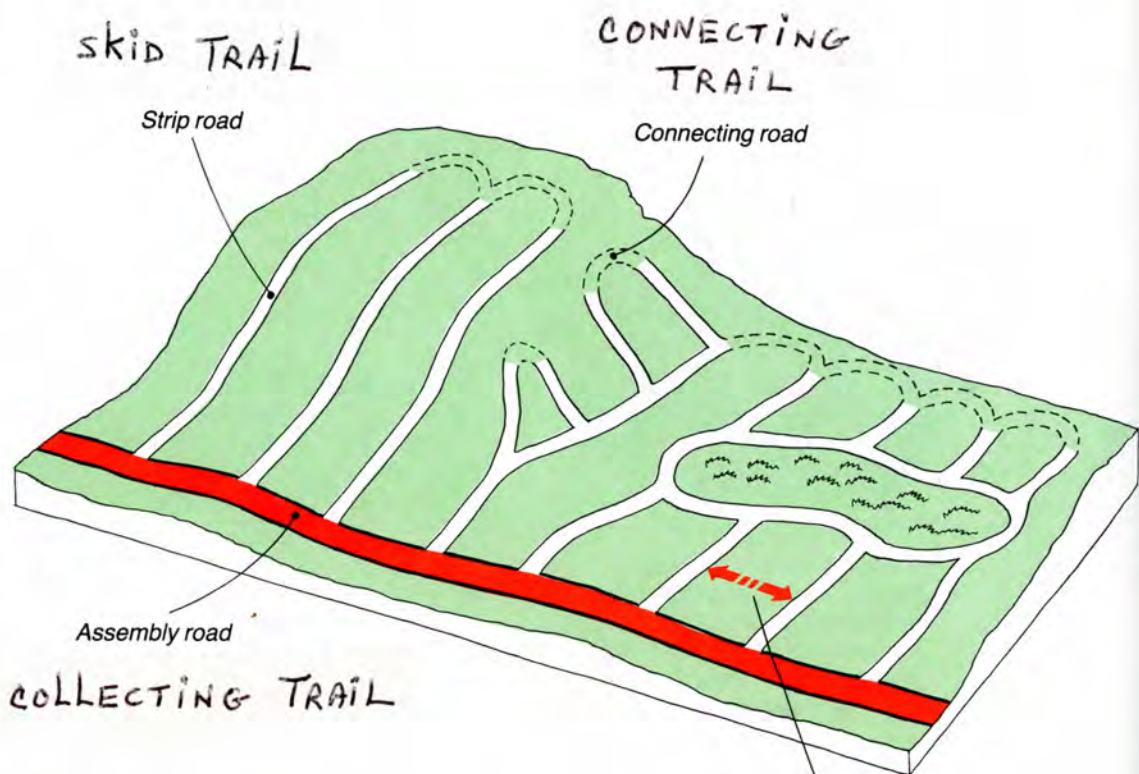

Assembly roads

The assembly roads should be placed in the lower sections of the area. Solid ground and a good surface structure are essential because many loads will be carried on these roads.

Strip roads

The distance between the strip roads depends on which logging method you choose. It can range from 65–100 metres when winching in a thinning to 15 metres in a clear-cut.

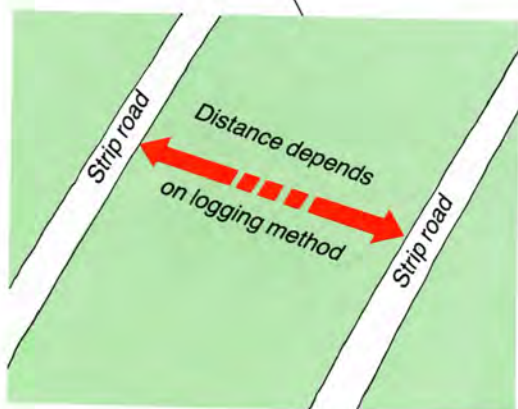

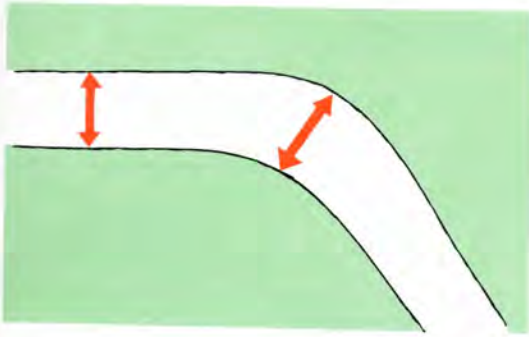

The strip roads should be approximately 4 metres wide. In curves the width should be increased to 4.5 metres because the trailer will cut the corner.

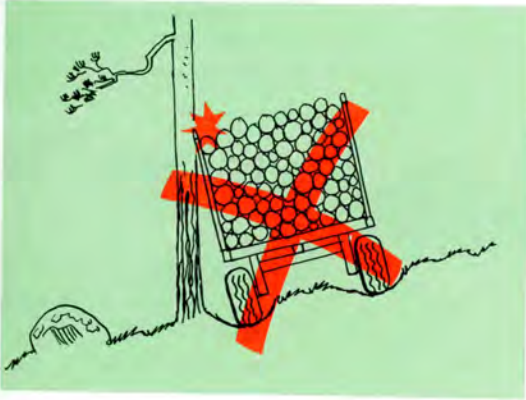

The strip roads should be as long as possible. On a slope the road should be placed as close to the straight uphill line as possible. Roads across slopes increase the risk of rolling over and damage to residual trees.

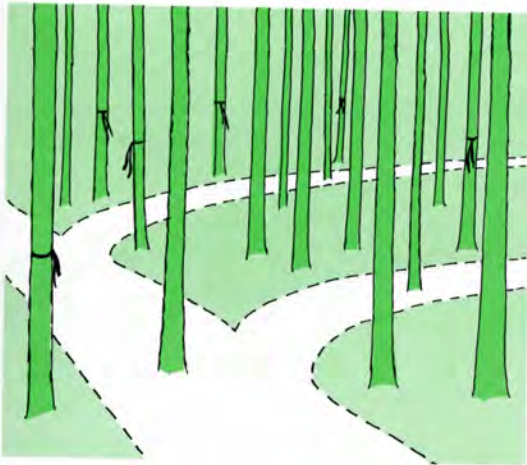

Flag the strip roads to make it easier to see which trees have to be cut to create the road. Use different coloured tapes to mark assembly roads and strip roads. Have the knot face the road centre. Mark the boundaries of the logging area with distinctive coloured tapes.

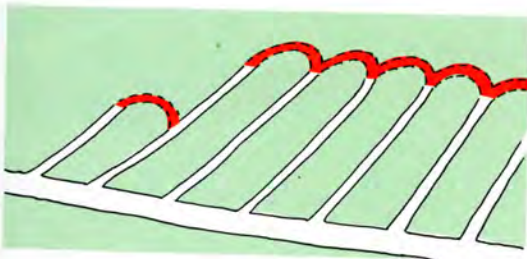

Connecting roads

Connecting roads should permit driving between strip roads (no turning at rear end).

Choice of logging method

Farm tractor and forwarder

I *If you are producing 3 metre wood, this method is simple to use.*

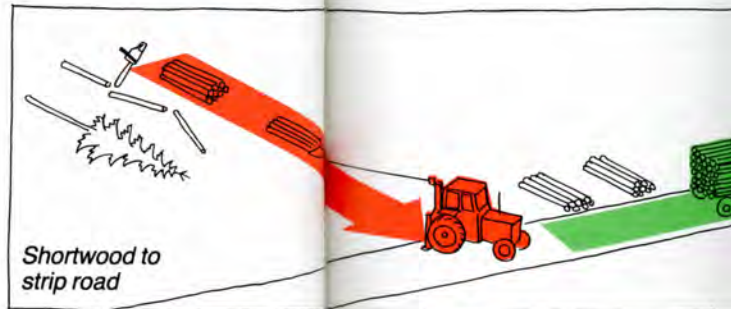

II *If you are producing pulpwood in random length you can bring out bigger winch loads with this method.*

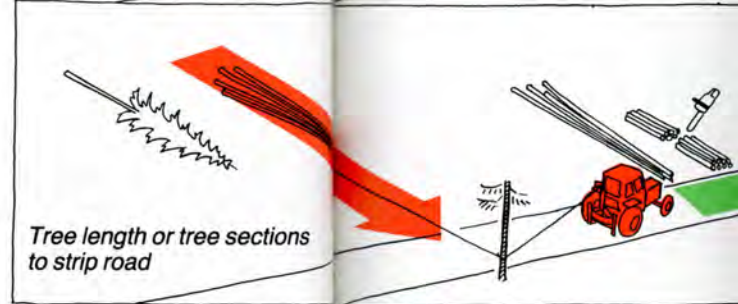

Only farm tractor

III *If you have a distance between the logging area and the landing (truck road) which is less than 500 metres you can use this method.*

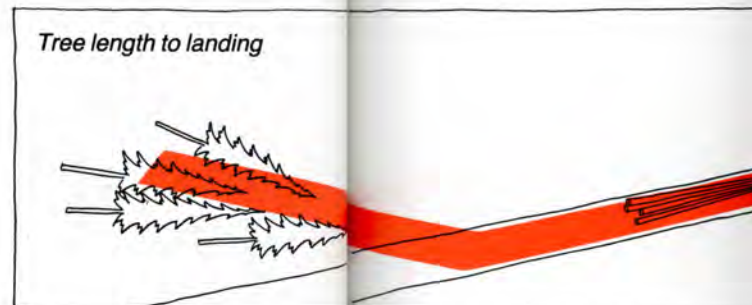

IV *If you have a forwarding distance of up to 2 km between logging area and landing (truck road), this method can be suitable.*

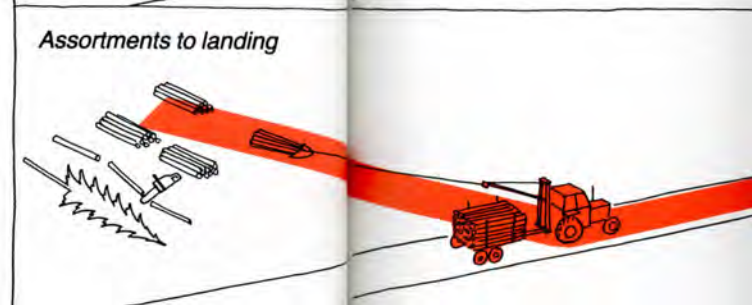

Shortwood to strip road

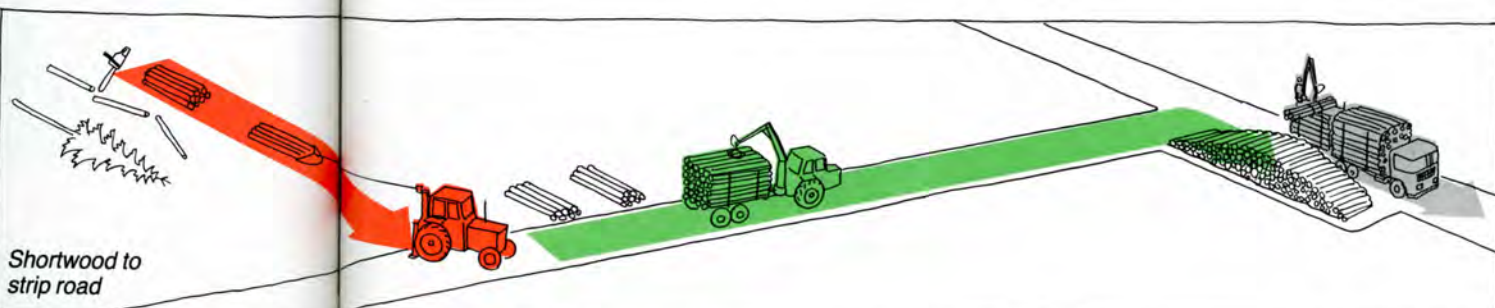

Tree length or tree sections to strip road

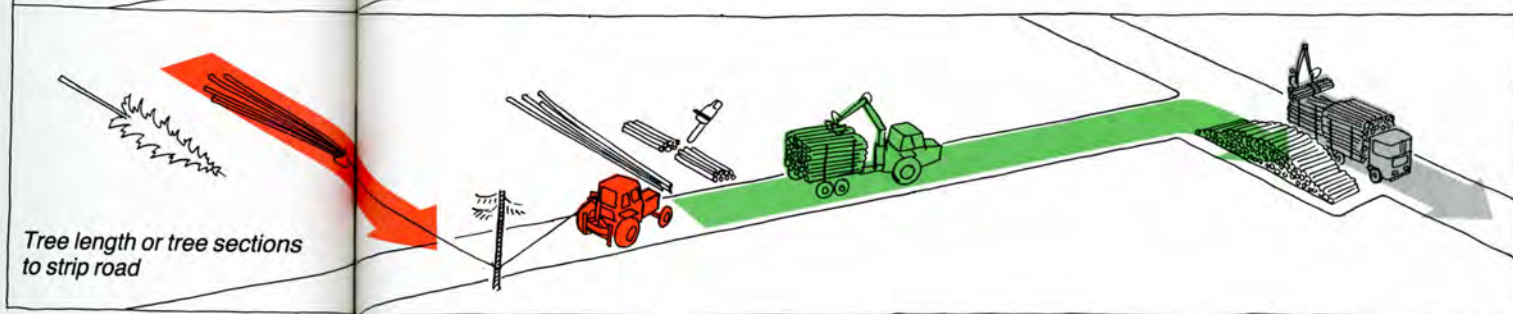

Tree length to landing

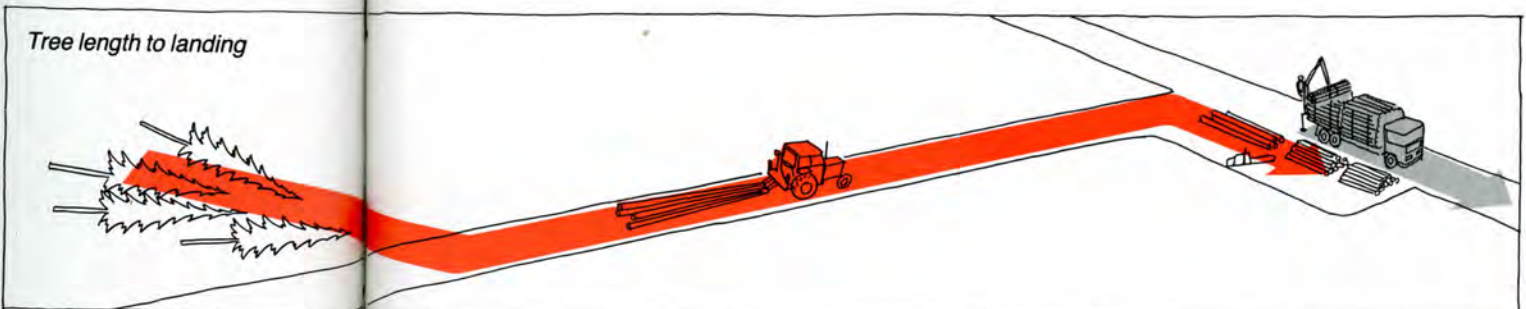

Assortments to landing

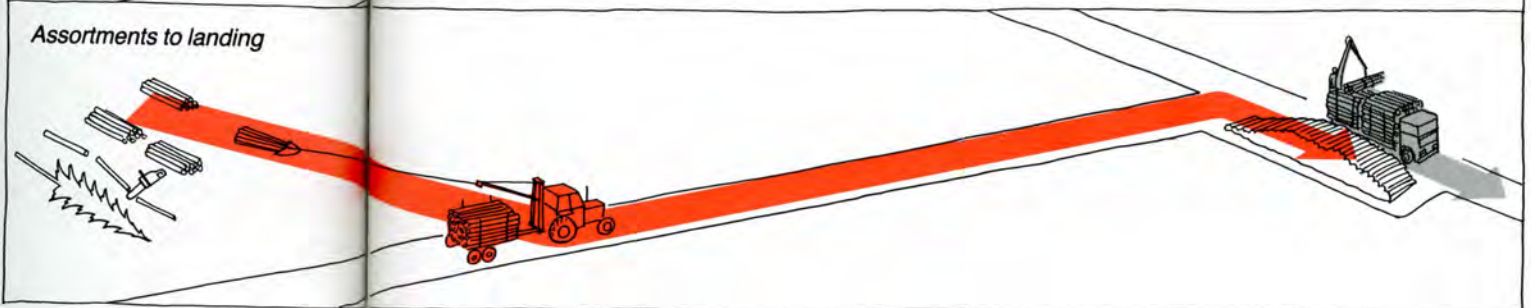

What kind of method suits me?

Method	Equipment	Suitable winching distance	Maximum terrain transport	Can be used in thinning	clear-cut	Requires directed felling
I. Shortwood to strip road	Winch Skid pan Tire chains Belly pan Valve stem protectors, etc. PTO shaft Remote control device or radio	40–60 m	–	Yes	Hesitantly	Advantage
II. Tree length or tree sections to strip road	Winch Chokers (Skid pan) Tire chains Belly pan, valve stem protectors, etc. PTO shaft Remote control device or radio	40–60 m	–	Yes	Hesitantly	Yes
III. Tree length to landing	Winch Chokers Tire chains Belly pan Valve stem protectors, etc. PTO shaft Remote control device or radio	40–60 m	Approx. 500 m	Hesitantly	Yes	Yes
IV. Shortwood to landing	Crane Skid pan Trailer Load straps Binders PTO shaft Remote control device Dump beam Tire chains Belly pan Valve protector, etc.	40 m	1–2 km	Yes	Yes	Advantage

Requires bunching in stand	Work on landing	Da to log
----------------------------	-----------------	-----------

Yes	No	No
-----	----	----

Yes	No	No
-----	----	----

No	Yes	Yes
----	-----	-----

Yes	Yes	No
-----	-----	----

Used in clear-cut	Requires directed felling
Hesitantly	Advantage
Hesitantly	Yes
Yes	Yes
Yes	Advantage

Requires bunching in stand	Work on landing	Damage to saw-logs	Risk of damage to residual stand	Capacity of winch skid pan	Load size	Equipment costs (approximate) 1982
Yes	No	No	Small	Approx. 0.6 m ³ piled not barked	—	With line control Approx. 8,800 SEK (\$1,800 U.S.) With radio Approx. 11,000 SEK (\$2,300 U.S.)
Yes	No	No	Yes	Approx. 0.7–1.0 m ³ stacked not barked	—	With line remote control Approx. 8,600 SEK (\$750 U.S.) With radio 10,900 SEK (\$2,250 U.S.)
No	Yes	Yes	Yes	—	Approx. 1.0–2.0 m ³ stacked not barked	Same as above
Yes	Yes	No	Small	Approx. 0.6 m ³ stacked not barked	Approx. 5 m ³ stacked not barked	With line remote control Approx. 17,000 SEK (\$4,000 U.S.) Remote control with only one channel is a Safety Risk!

Method I: Shortwood to strip road

Many times it is an advantage to process the trees into 3 metre lengths or some other standard length in the stand rather than handling tree sections or tree lengths.

Advantages:

You do not always have to use directed felling although the method usually is recommended.

You can winch directly with the tractor without using a snatch block. There is no need to cut bolts and winch the remainder across the strip road which is common practice when you winch tree sections and tree length. In difficult areas with a lot of boulders it is easier to handle three metre wood with a corner hook or snatch block than to handle longer assortments.

Disadvantages:

You cannot use the maximum capacity of the winch since the wood is cut up in 3 metre sections.

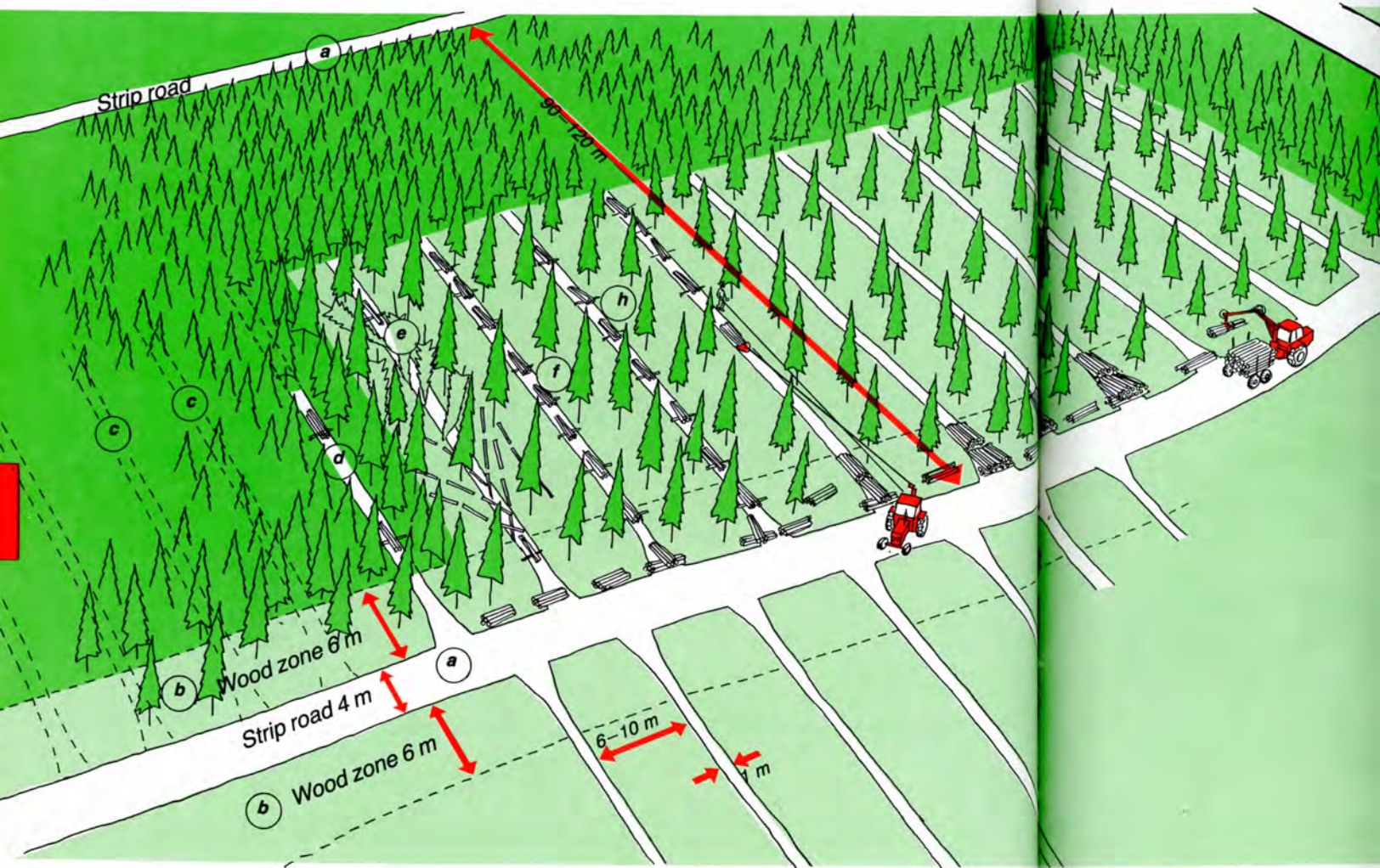

Work me

- Start by
- and the
- Then lay
- Clean a
- Use dire
- because
- handle i
- determi
- with a lo
- Pile the
- Raise th
- assortm
- The fini

Work method

- a. Start by cutting out the strip road
- b. and the wood zones
- c. Then lay out the winch trails.
- d. Clean and cut out the winch trails.
- e. Use directed felling where feasible. Do not overdo this because the biggest piece of wood which you have to handle is a 3 metre bolt. Forcing the tree into a pre-determined direction can cause problems in a dense stand with a lot of branches.
- f. Pile the wood with one assortment in each pile.
- g. Raise the piles off the ground but do not use the saleable assortments.
- h. The finished winching trail should be straight.

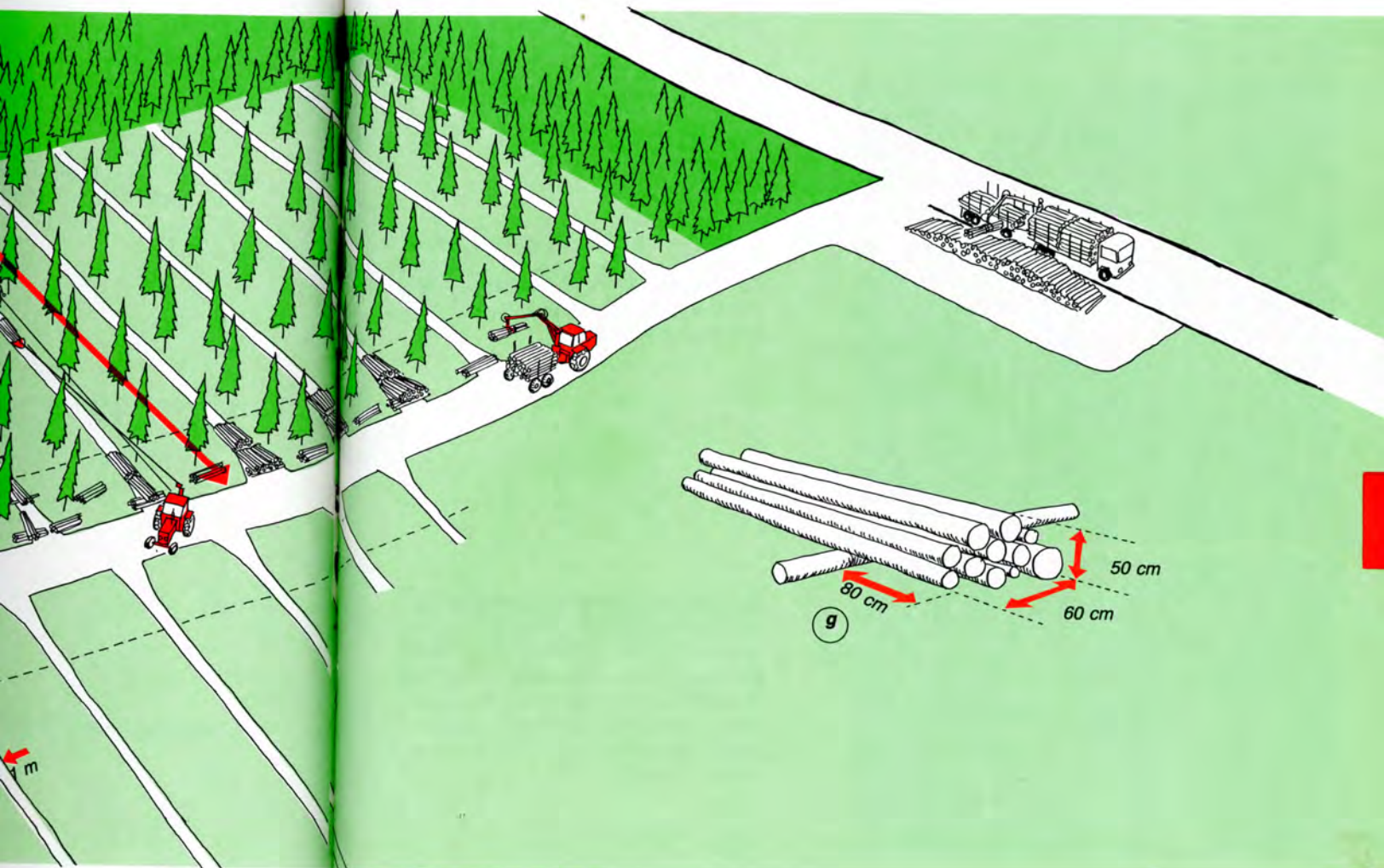

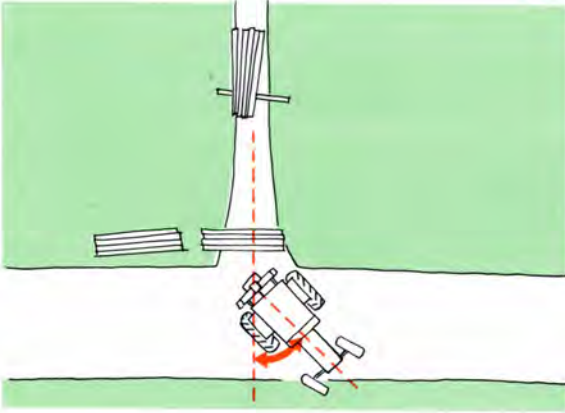

Winching

Position the tractor in the middle of the winch trail mouth preferably in a 45° angle to the direction of winching. Recommended motor speed is approximately 900 rev/min. Lower the winch support legs. If the winch is vertical, the cable is easy to pull out. Use radio or a control line for remote control. A radio can be used up to a distance of 100 metres. A line with a retraction device ("line caddy") will reach 45 m from the tractor.

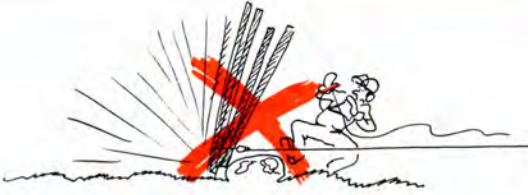

You should use a skid pan if you are winching 3 metre wood. The skid pan will substantially reduce the risk of getting the load stuck. The skid pan will also reduce friction and damage to residual trees.

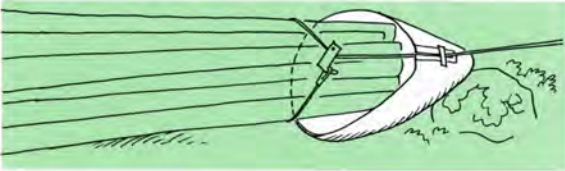

Pull the skid pan with the cable when you are going out to fetch a load. Do not carry the skid pan.



Turn the skid pan so that it faces the direction of winching. Pull out a few extra metres of cable before choking the bundle. Face the winch. Keep the slide hook in one hand and the cable eyelet in the other. Insert the cable under the wood from the front of the wood bundle.

Unless the cable draw point is in the middle of the bundle, the skid pan will not go straight.

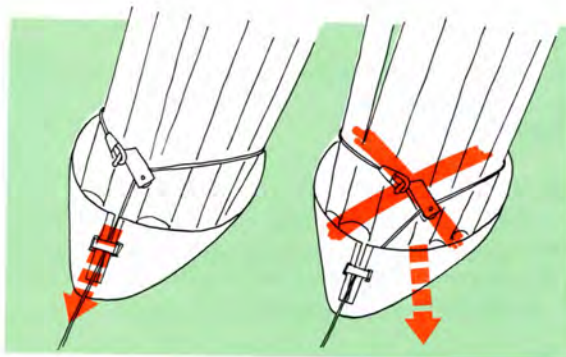

Walk behind the load when you are winching. Stop if there is a risk of getting stuck and adjust the direction by pulling the skid pan sideways.



A skid pan can be used to winch a bundle up on another bundle if storage space is limited.

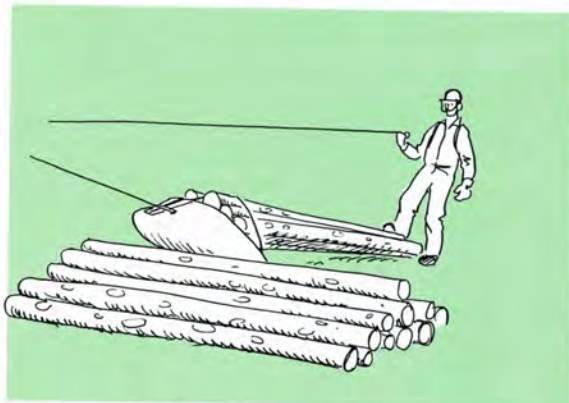

You can leave two bundles, one behind the other, near the strip road. Make sure the loader can reach them.

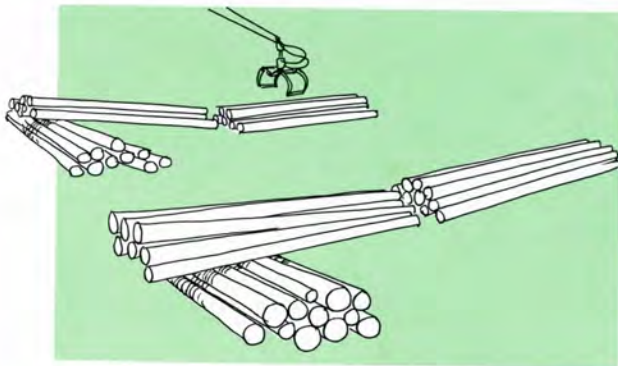

Method II: Tree length or tree section to strip road

In a thinning operation you can process the trees into random length or 6 or 9 metre lengths and then winch the wood out to the strip road.

Advantages:

Wood cut in tree sections (6 metre) do not require winching of any wood across the strip road. Skid pans can be used. You will get more wood volume per skid pan load than if you are winching 3 metre wood.

Disadvantages:

The method requires bucking at strip road side. If you are winching tree length you will have to carry heavy chokers along the winch trail.

Tree length winching can damage the residual stand. It requires some manual pre-bunching and directed felling.

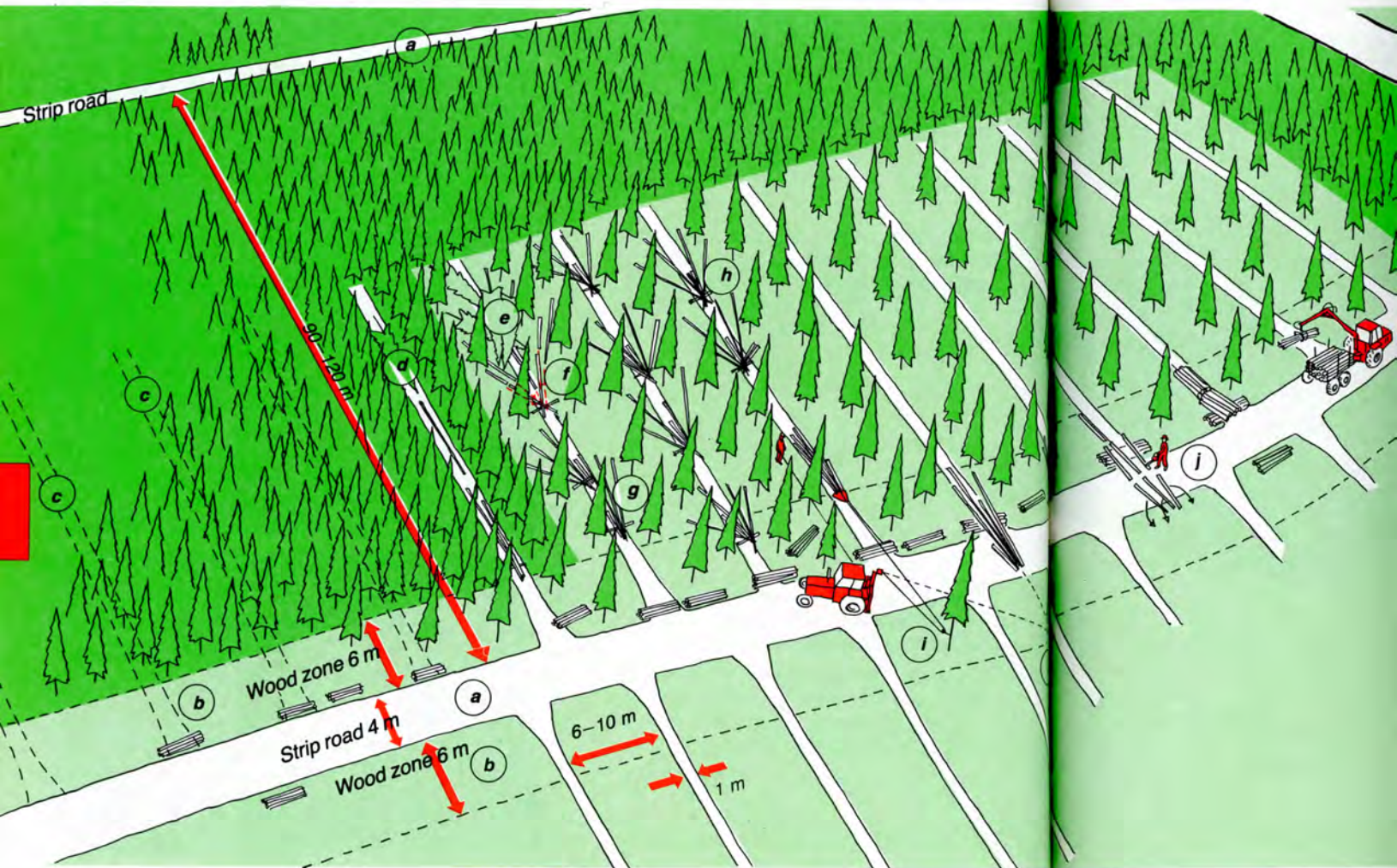

Work me

Basically th

a. Start by c

b. and the v

c. Then lay

d. Clean an

e. Make su

across th

leave les

bunching

f. Cut and

Place th

g. Wherev

h. The finis

i. If you are

use a sn

road. In

j. Bucking

Work method

Basically the same as for Method I.

- a. Start by cutting out the strip road
- b. and the wood zones.
- c. Then lay out the winch trails.
- d. Clean and cut out the entire winch trail.
- e. Make sure you fell each tree so that it falls on an angle across the trail with the top at the side of the trail. This will leave less slash in the trail. Wherever possible fell to make bunching easier.
- f. Cut and bunch any stems which are longer than 9 metres. Place the bunch on a support.
- g. Wherever possible have only one assortment per bunch.
- h. The finished winch trail should be straight.
- i. If you are winching wood longer than 6 metres you must use a snatch block attached to the other side of the strip road. In other aspects as for Method I.
- j. Bucking the wood is done after the winching.

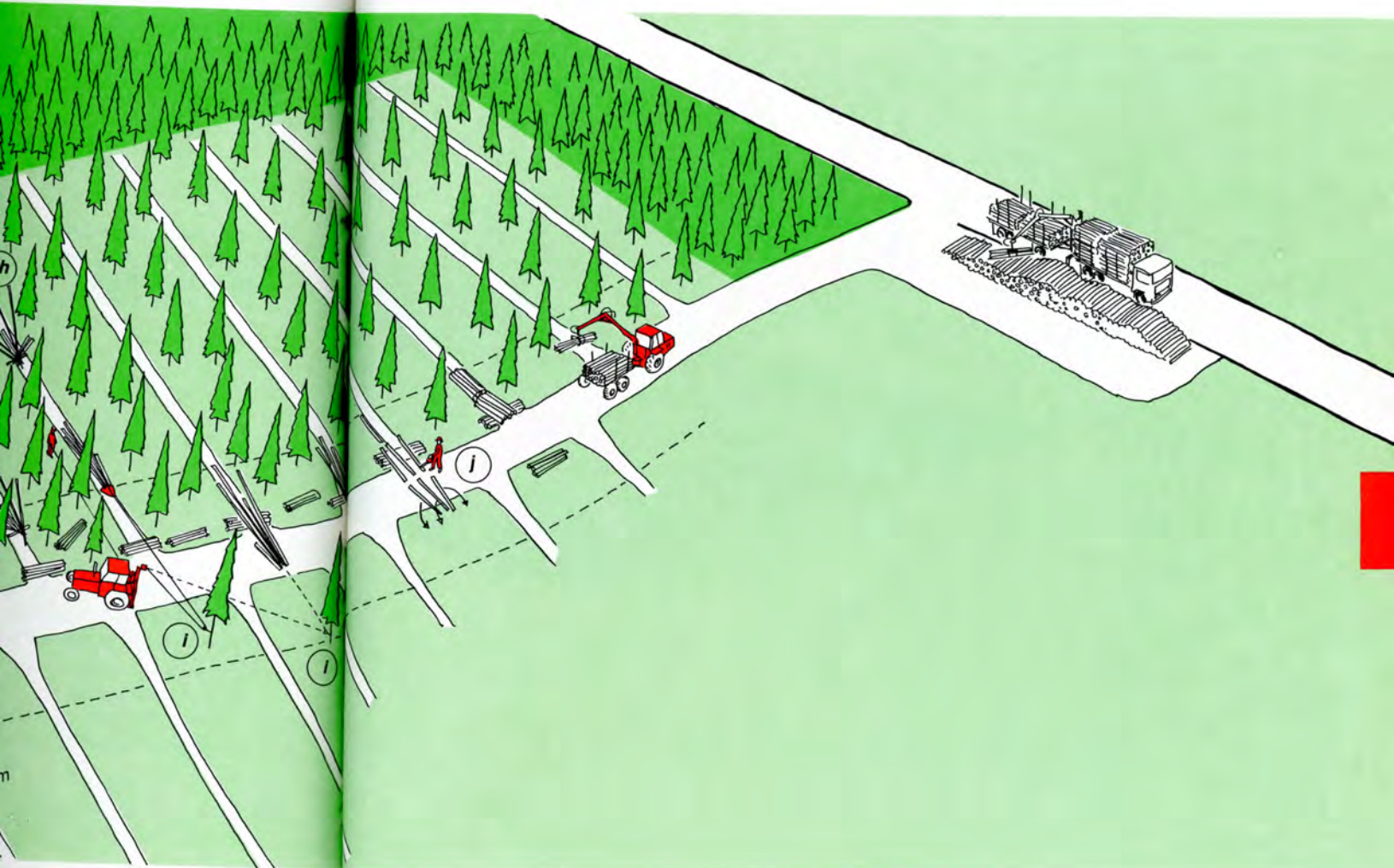

Method III: Tree length to landing

This is a suitable method when the same person cuts and skids out the wood. The distance between the logging site and the landing should not exceed 500 metres. The method is most suitable for a winter-condition, clearcut operation.

Advantages:

You can make the final decision on how to buck the tree at the landing. Properly used, the method will leave no wood under the snow.

Disadvantages:

The size and configuration of the landing will determine whether this method can be used.

If used when the ground is bare, soil is likely to stick to the trees creating problems when bucking.

Chokers are heavy to carry along the trail.

It is heavy work to handle pulpwood on the landing.

Work me

a. Cut out th

b. Fell the tr

pattern w

towards

The swa

will redu

damages

It is impc

be handl

prevent

snowed

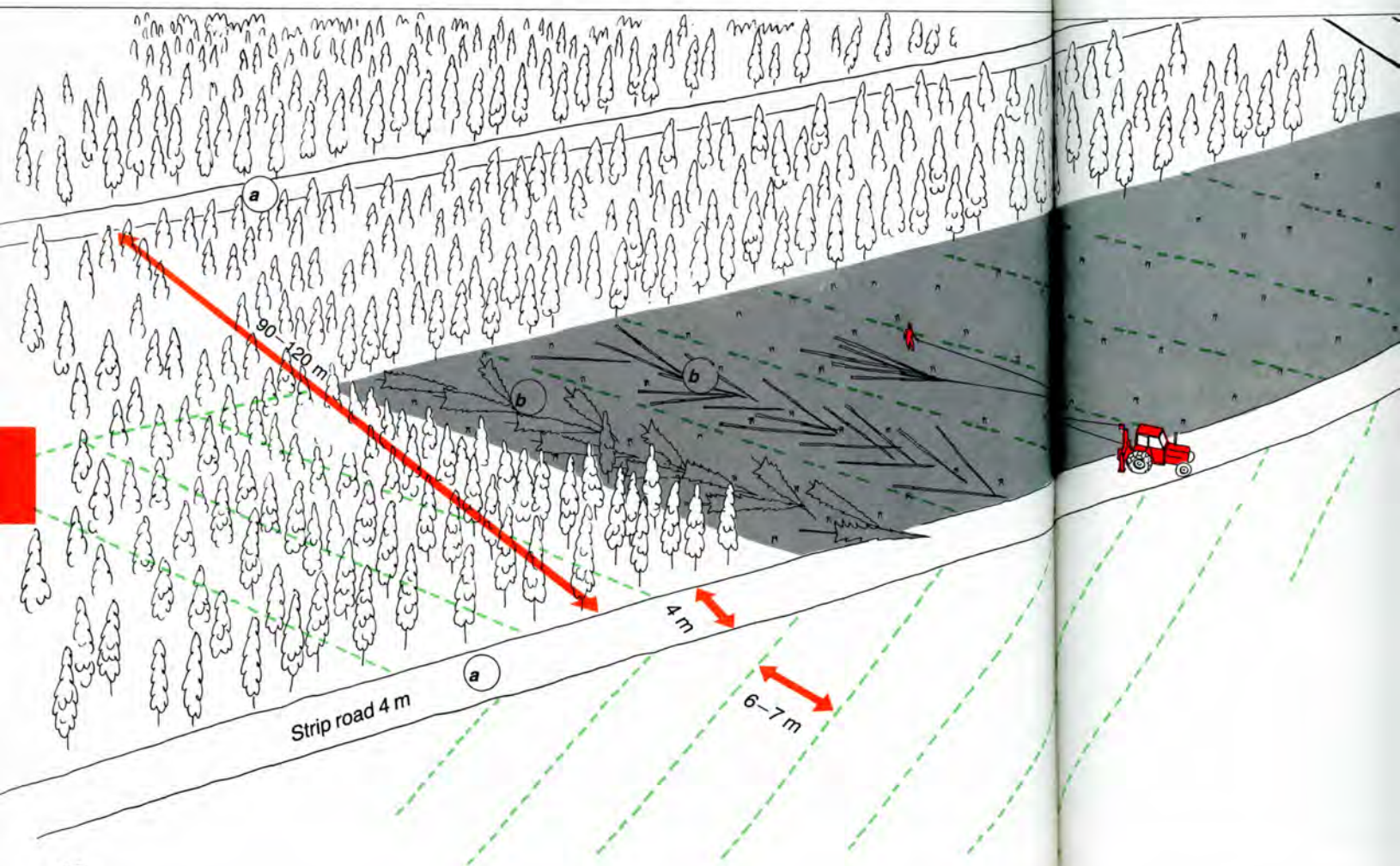

Work method

- a. Cut out the strip roads first
- b. Fell the trees between the strip roads in a fish bone pattern within a 6–7 metre wide swath with the tops facing towards the strip road.

The swaths should be at an angle to the strip road. This will reduce the risk of breakage and subsequent skid damages during winching.

It is important not to fell and process more trees than can be handled in one winch load. This procedure will also prevent wood from being accidentally left in the forest and snowed over.

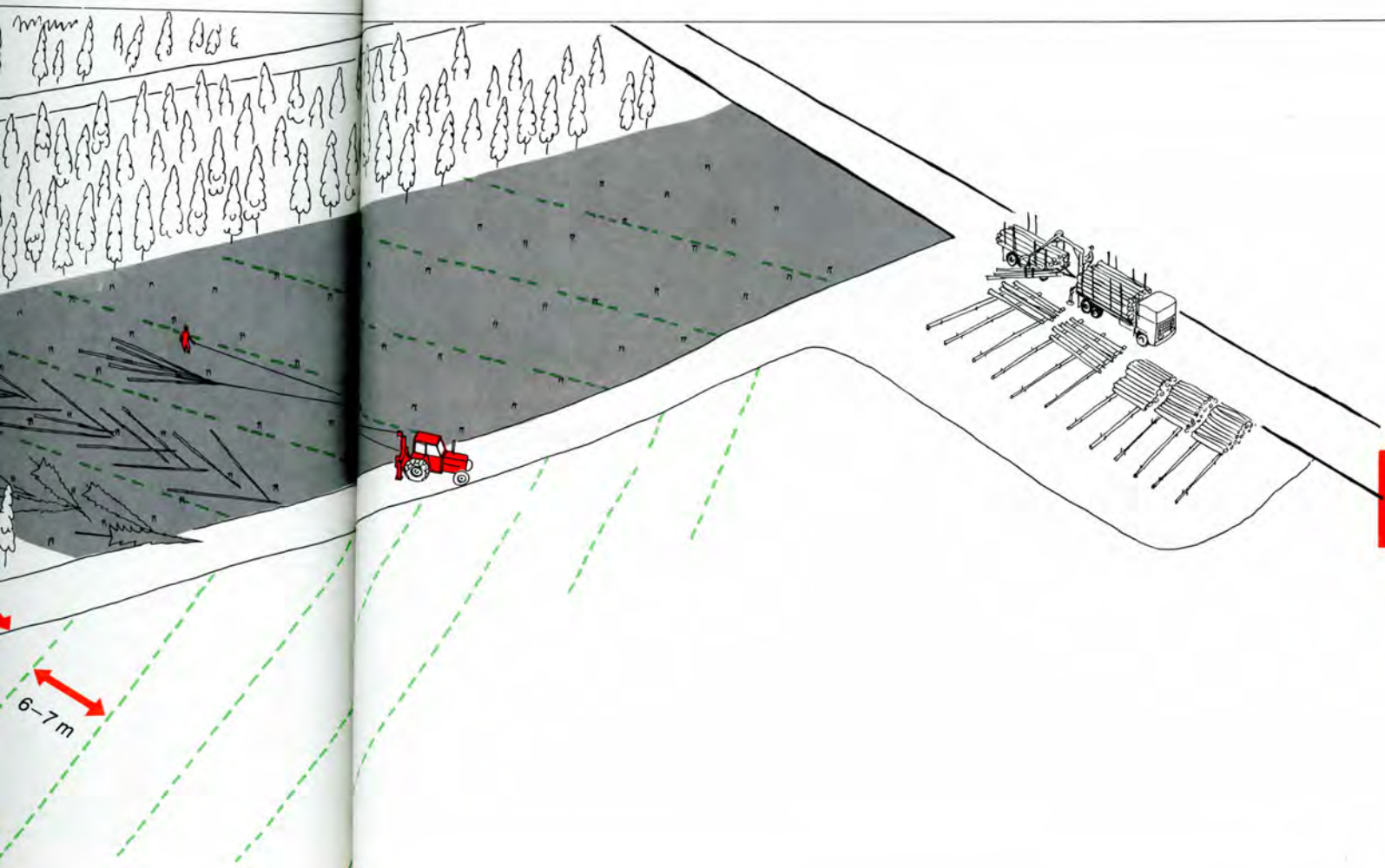

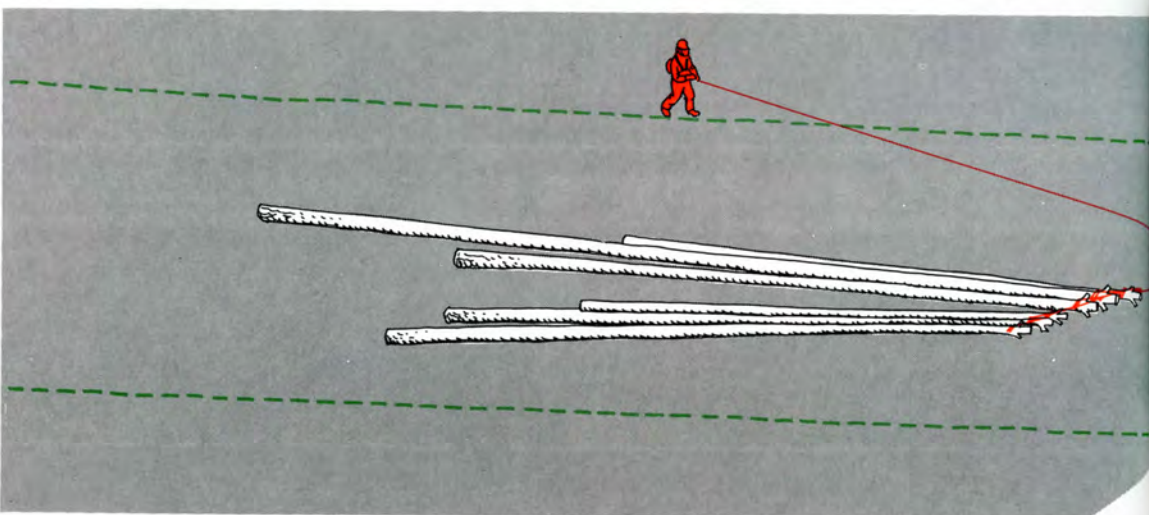
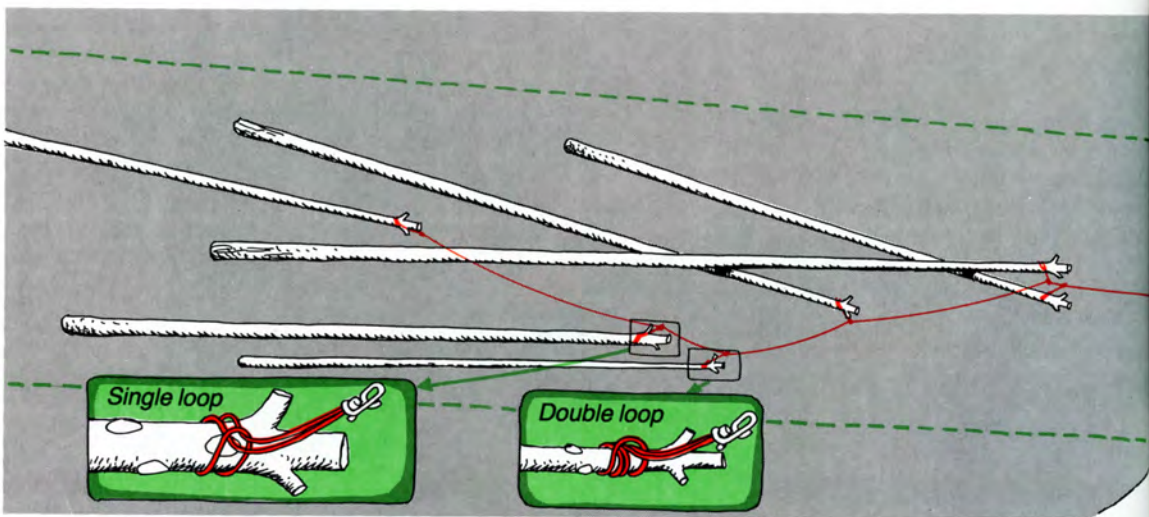
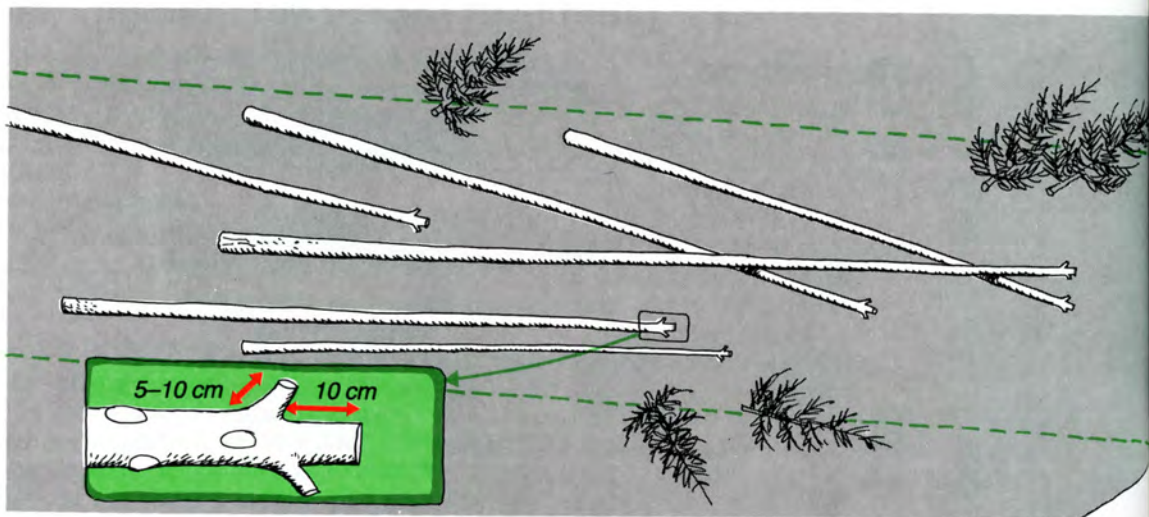

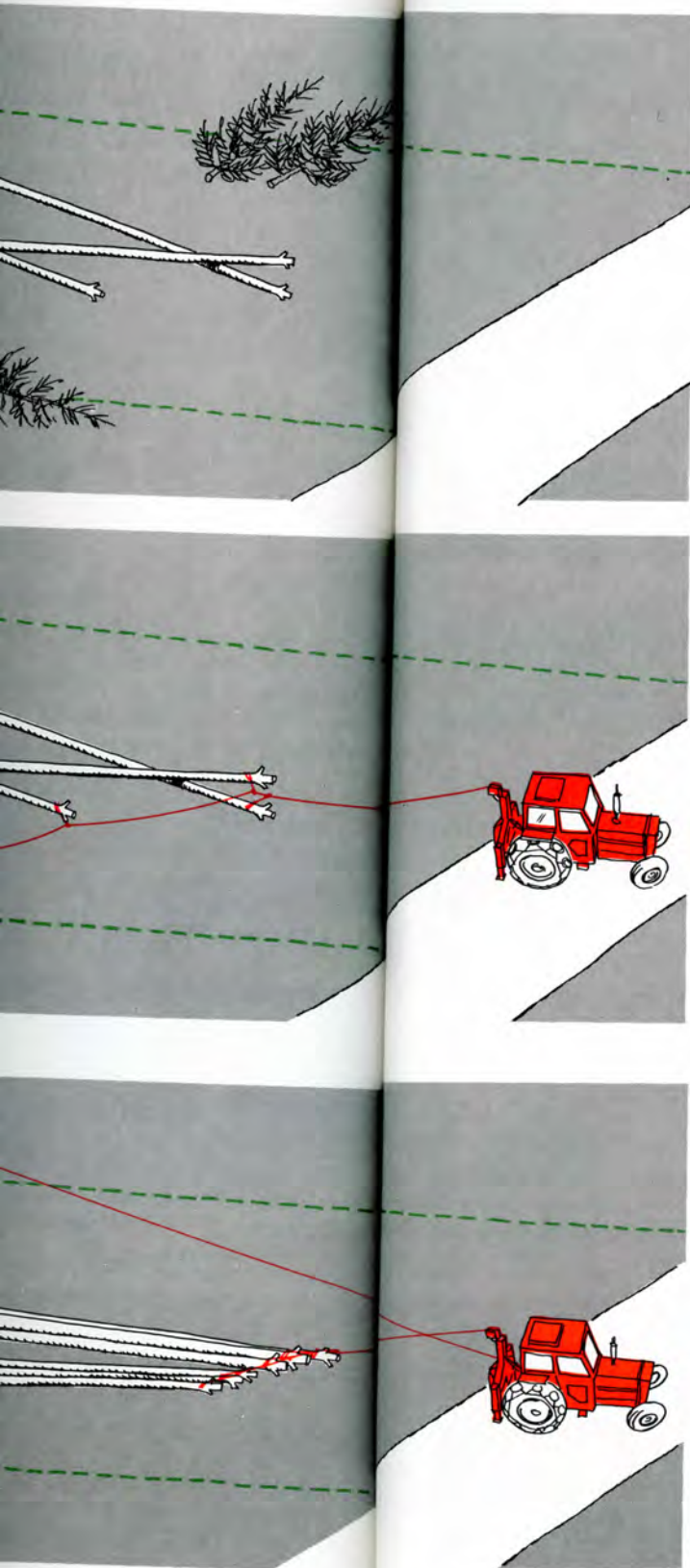

Preparation

Limb and remove the top in a normal manner but leave 2 or more branch stubs 5–10 cm in length approximately 10 cm from the top. Toss the tops aside.

Choking

Position the tractor straight in line with the winch direction. Lower the support legs. If the winch is vertical, the cable is easy to pull out. Decide the number of stems that can be winched at one time. Bring that number of chokers in one hand and the winch cable in the other. Pull the cable up to the last stem. Attach the choker first to the stems and then to the cable. The stems nearest to the tractor should be winched first. Material lying beneath other stems should be removed last. The choker is attached with a single loop behind the branch stubs left at the top of the stem. Small stems might require a double loop. Do not take too big loads.

Winching

Suitable motor speed is 900 rev/minute. Because of the danger of the cable breaking or the choker slipping, a control line or radio should be used. Do not start winching with a tense cable. Do not drag the clutch. Check to make sure stems are not lost. Do not winch the load too far.

Skidding

Attach the cable to the lower block and lock the winch drum. Lift the winch and stabilizer legs and secure them. The greatest resistance during skidding occurs when the load starts to move. Therefore, try to have the tractor positioned on solid and flat ground.

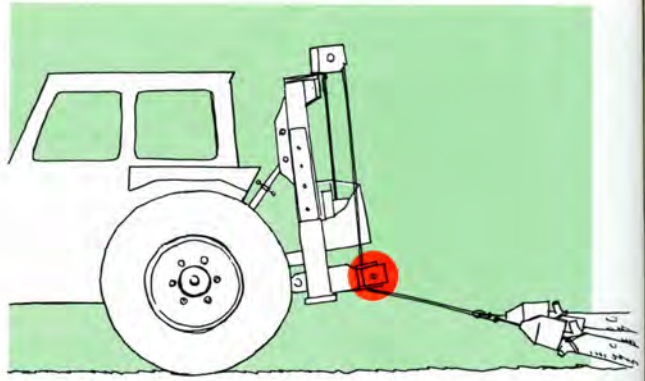

If you get stuck, you can drop the load, drive the tractor forward and then winch the load.

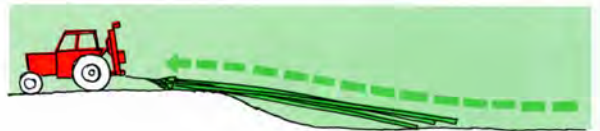
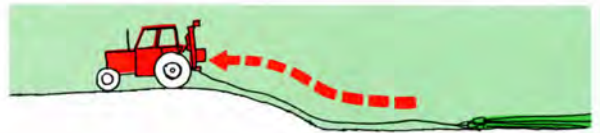

The landing

Lay out your landing so that you get at least two tiers with sawlogs first and then a few tiers with pulpwood. Use tree length runners. Anchor the runners so that you can drive across them with the tractor. The use of runners facilitates marking for cross cutting, bucking, rolling and piling. If pulpwood is scaled on the landing it should be placed along the truck road.

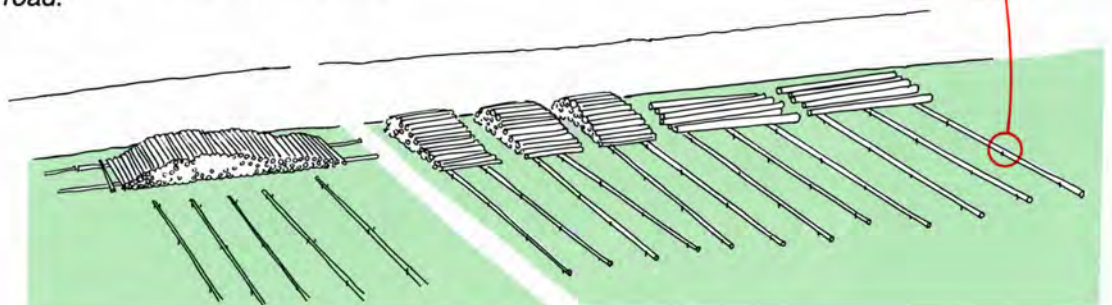

Bucking

When you arrive at the landing, you should drop the load in front of the first pile. Drive the tractor with the winch disengaged past all the other piles. Lower the winch on the support legs. Lay out the winch control line on the ground. Cut off the sawlogs and winch the rest of the load forward to the next pile. Finally remove the chokers and manually pile the pulpwood or use a wood grapple or fork mounted on your front end loader if you have one.

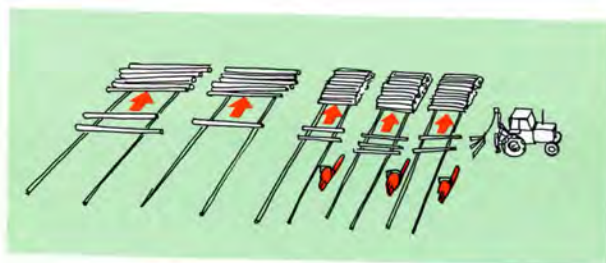
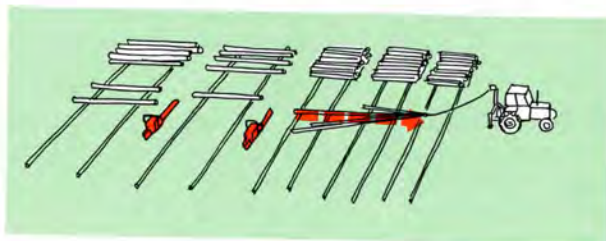
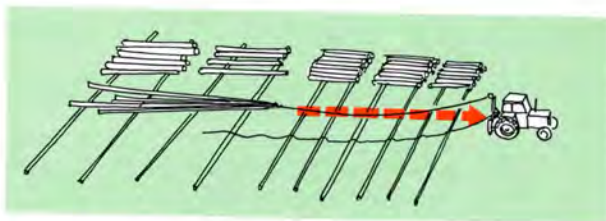

Piling

Manual piling of wood is heavy work. Sometimes you can push the wood together using the lower part of the winch while backing towards the pile. The best solution is a wood grapple or fork attached to a front end loader.

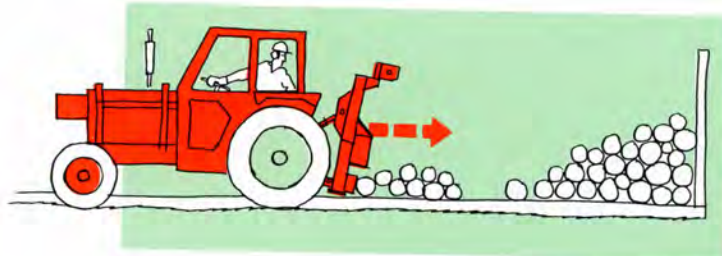

Work method

- a. First cut out the strip road. Branches should be left in the strip road to improve flotation. Remember to limb branchy tops so that a farm tractor can get by. Wood from the strip road should be bunched and placed along and parallel to the strip road so that it can be choked in the middle. For ease of loading and choking, bundles should be placed about 0.5 metres away from the main strip road.
- b. Clean and cut out the entire winch trail.
- c. Use directed felling where it is feasible and reduce the winching distance by felling towards the strip road.
- d. Place the bundles on proper supports so that they can be choked with a skid pan. Do not use saleable assortments for supports. Bundles should not contain a volume exceeding 0.5 m^3 stacked wood.
- e. Position the tractor on flat ground where the crane will work best. Lower the upper part of the trailer stakes on the winching side. Use a skid pan.

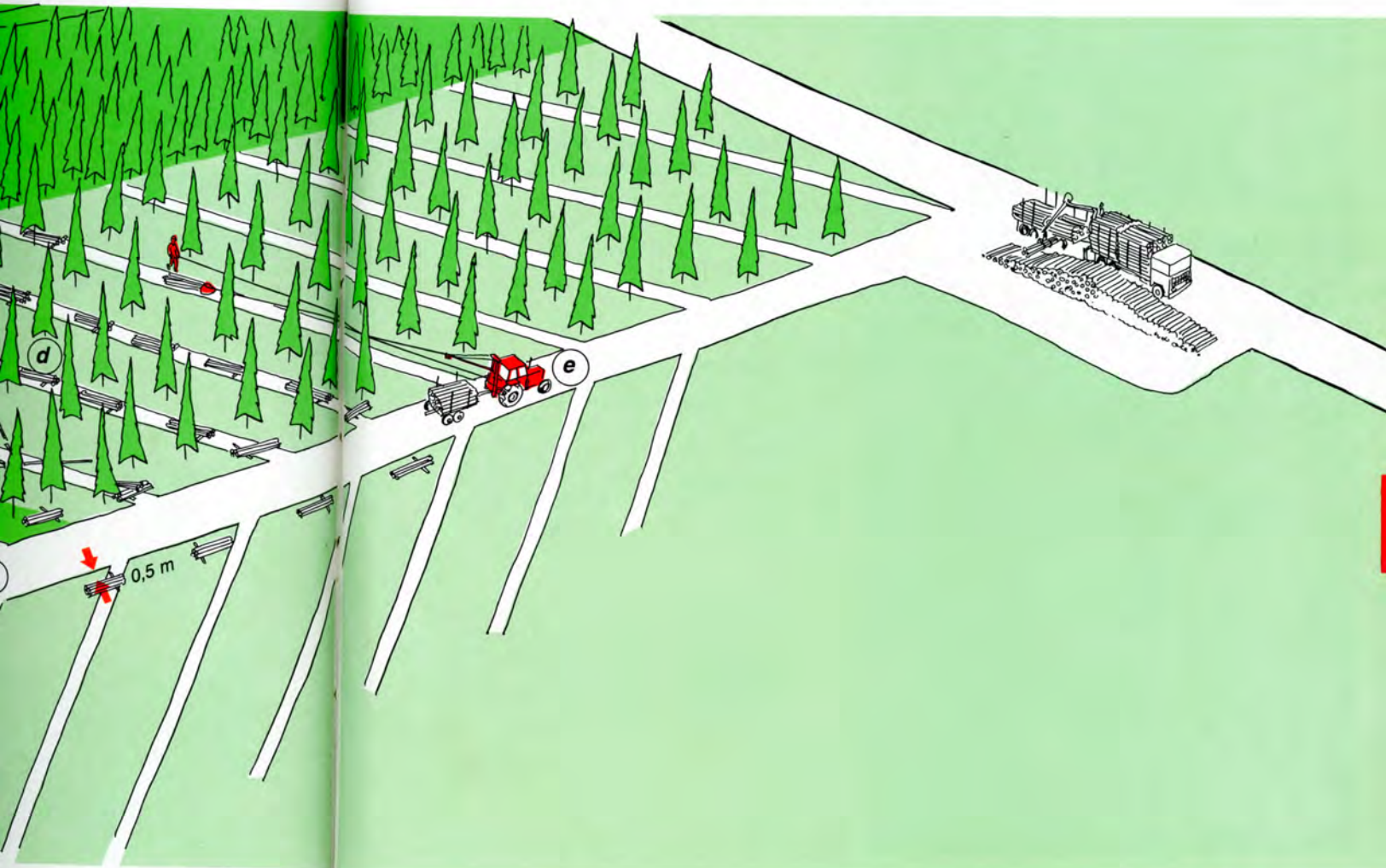

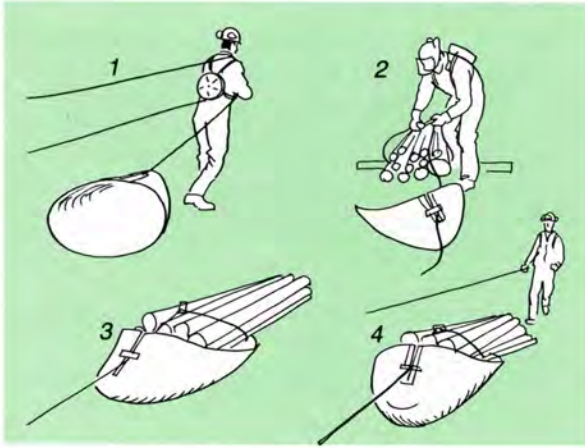

Winching

Winching is carried out basically in the same manner as described on pages 76–77.

1. Pull out the cable, hauling the skid pan behind you.
2. Turn the skid pan in the winching direction. Haul in a few metres of winch cable and face in the winching direction. Keep the skid hook in the left hand and the wire eyelet in the right hand. Bring the cable in under the wood from the front end of the bunch.
3. Attach the cable so that it is centered over the load. This will facilitate straight winching.
4. Walk behind the load while winching. Adjust the skid pan sideways if required.

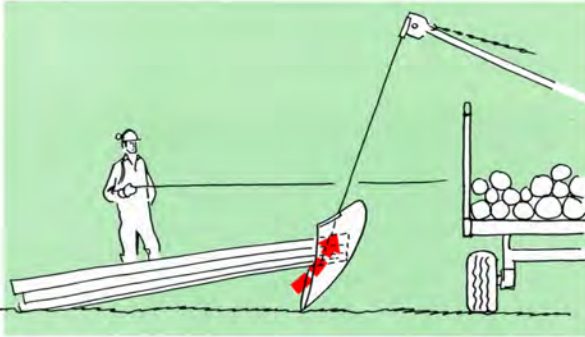

5. Winch until the skid pan is lifted up in front of the load.

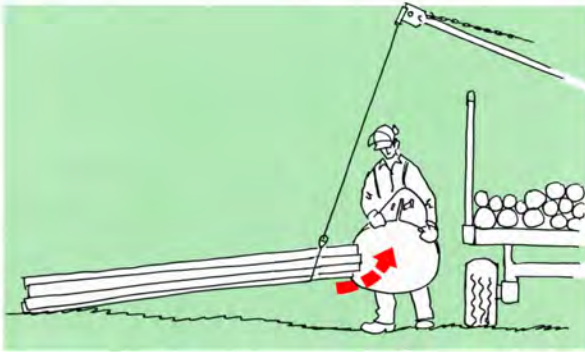

6. Stop and disconnect the skid pan.

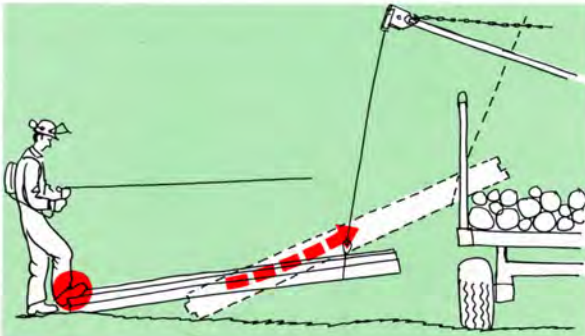

7. Winch the front end of the load up onto the trailer. Support the rear end of the load with your foot. You can handle sawlogs in the same manner.

Loading

1. Move the cable to the middle of the load.

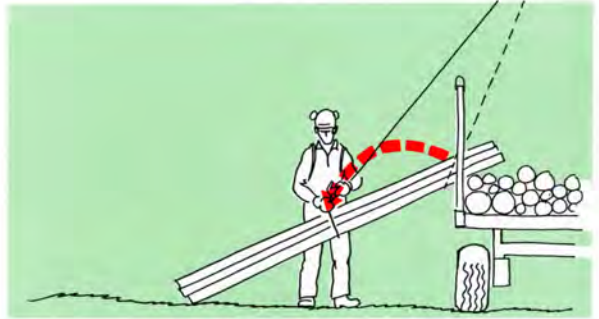

2. Lift the load and swing it around with the aid of a picaroon and then lower it.

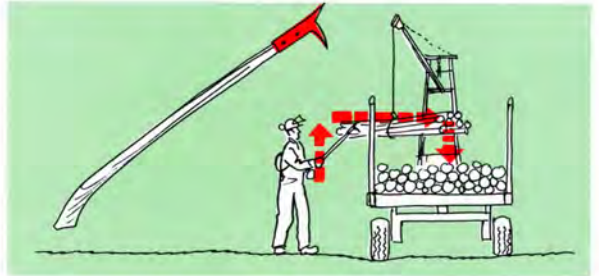

3. Disconnect the slide hook and remove the cable.

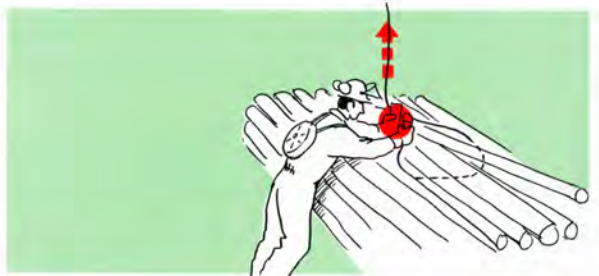

4. Manually adjust the wood if required. Try to keep the ends even. Remember the tighter the load, the easier it is to unload it at the landing. A platform to stand on makes adjustment easier.

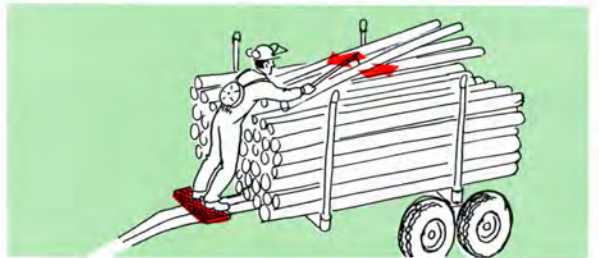

5. When the load is adjusted strap it using a binder. Make sure that the binder is on the same side where the dump beam will be attached.

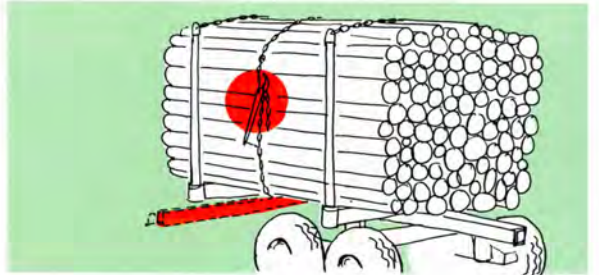

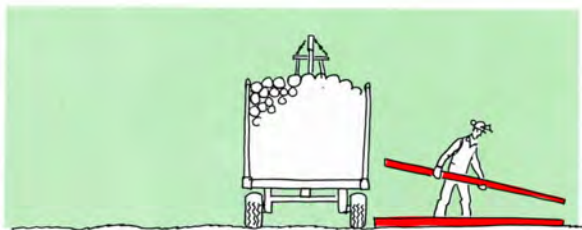

Unloading

1. Place runners in position.

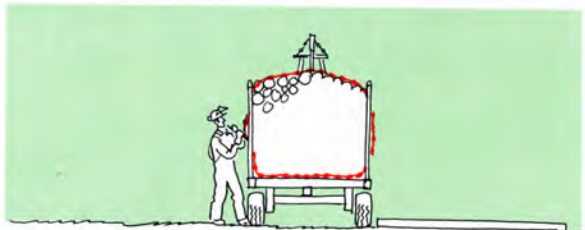

2. Re-strap the load to make it as tight as possible.

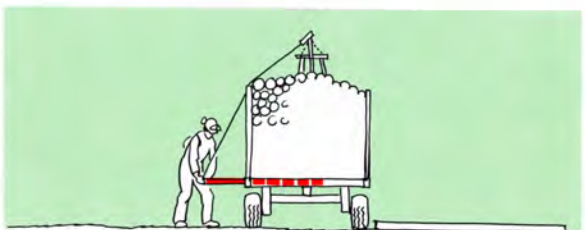

3. Connect the cable to the dump beam.

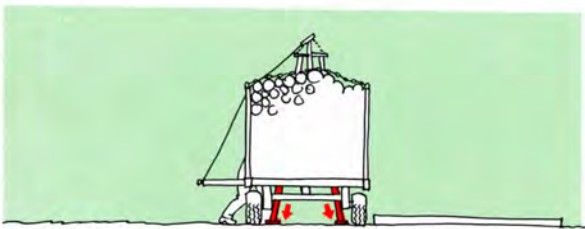

4. Lower the crane support legs.

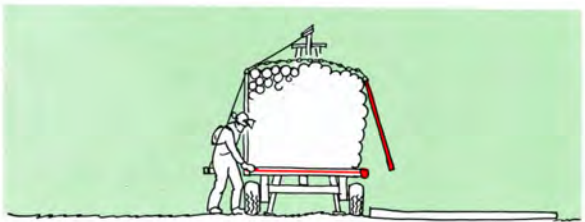

5. Release the stakes on the dump side.

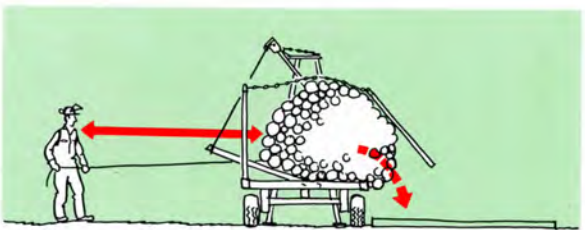

6. Use remote control when unloading. This way, you can work outside the risk zone.

7. Leave the strap and binder on the dumped load. Place two pulpwood sticks with their tops down leaning against the load. This will not only make it easier to remove the strap after another load has been added but also keep the wood together. You will need at least three sets of load straps if you are working with two assortments.

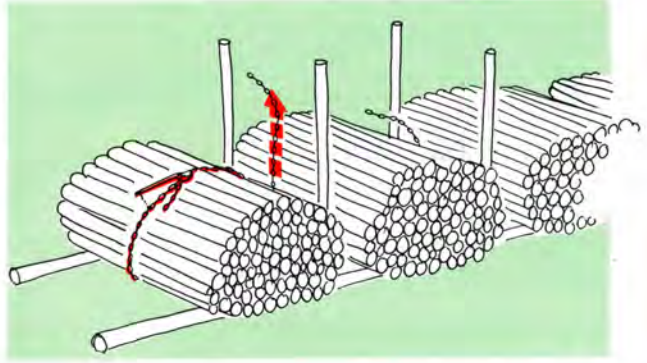

Other ways of unloading

If your trailer is equipped with a hydraulic tip beam you can unload using the hydraulic power of the tractor.

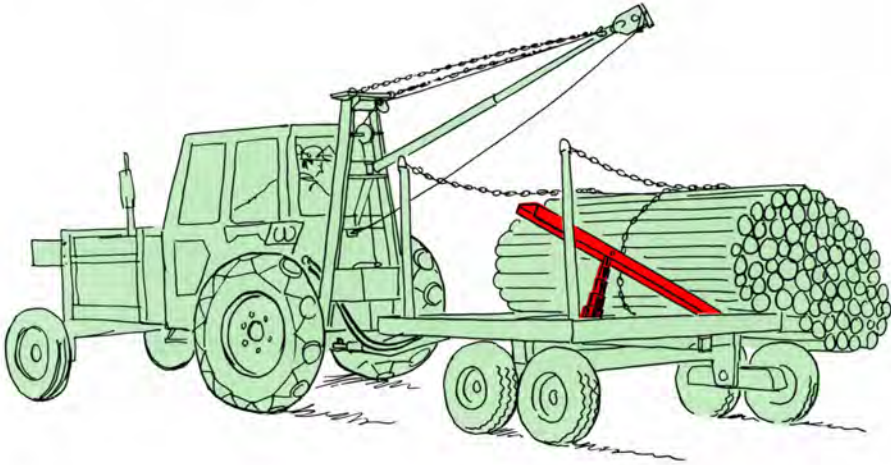

Economy

Generally by doing forest work yourself, you are avoiding some of the costs of hiring a contractor to do the job.

Your hourly "salary" is dependent on:

- How much work you can do
- How much personal overhead costs you have
- How much you plan to do yourself and how much a contractor will do.

You should, in theory, do the kind of work which gives the best hourly return (salary). You should do activities where you can produce a lot with low equipment cost.

The type of work you do in the forest will depend on a number of circumstances. It can depend on other work opportunities, what you enjoy doing, what you are most interested in doing, what kind of equipment that you have and so on.

If you have no other work and there is time available for forestry work, you can then do all the work yourself as long as it is cheaper than hiring a contractor.

In the following calculations approximate prices, different equipment alternatives and different annual harvesting volumes are identified.

The costs per solid cubic meter include depreciation, interest at 10 % per year, repairs and maintenance. The price level refers to 1982.

First, a few words about depreciation. If you only harvest 100 m³ of wood/year, your equipment will not be worn very much. But if you harvest 1,000 m³ of wood/year the wear on your equipment will be substantial. The equipment can also become obsolete and uneconomical because better, more efficient equipment has been developed. This new equipment may increase production, simplify the work and reduce the costs.

To figure out your own costs you should make a calculation like the following:
(NOTE: in May 1982 one SEK (Swedish crown) = about 20 cents, Canadian Dollar, about 23 cents United States Dollar and 10 pence, Great Britain Pound.

Calculation example

Conditions

Price Level: 1982

Interest: 10 %

Depreciation time and depreciation costs:

Equipment	Purchase Price	Depreciation time and costs for an annual harvest of					
		100 m ³ Year	SEK/m ³	400 m ³ Year	SEK/m ³	800 m ³ Year	SEK/m ³
Forestry attach for farm tractor	2,300	10	3.70	6	1.30	4	0.90
Winch	3,900	10	6.30	6	2.20	4	1.50
Skid pan (glass fibre)	660	8	1.20	3	0.70	1	0.90
Crane	4,500	10	7.30	6	2.60	4	1.80
Remote control line	680	10	1.10	6	0.40	4	0.30
Trailer (5 ton)	7,000	15	9.20	8	3.30	6	2.00
Chokers	300	10	0.50	6	0.20	4	0.10
Dump beam	400	10	0.65	6	0.20	4	0.15
Hand tools	700	10	1.10	6	0.40	3	0.35
Chainsaw	2,700	6	6.20	4	2.10	3	1.35

No depreciation is calculated on the farm tractor here since it is expected to be used primarily in agriculture work.

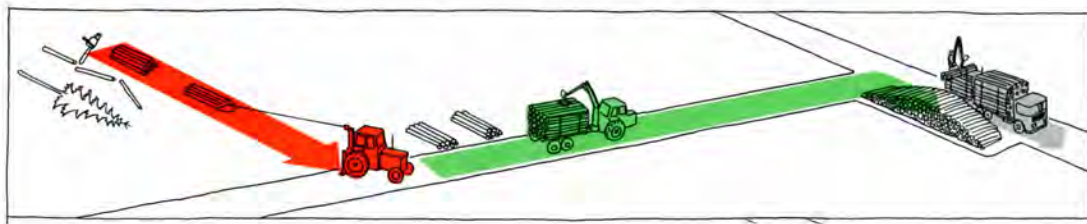

Method I

Short wood to strip road

Felling production: 1 m³/hour

Average winch distance: 25 metres

Winching production: 4 m³/hour

Forwarding distance (transport to truck): 250 m

Forwarding costs: 17 SEK/m³

Equipment: Chainsaw, forestry equipped farm tractor, winch, remote control line, skid pan, hand tools

Equipment costs (excluding tractor): 10,940 SEK

Operating costs: Farm tractor 12 SEK/hour,
Chainsaw 3 SEK/hour

Salary cost (including fringe benefit payable by the operator): 50 SEK

Working hours per day: 6

Costs SEK/m³ for annual harvest of:

	100 m ³	400 m ³	800 m ³
--	--------------------	--------------------	--------------------

Felling costs

Chainsaw depreciation	6.20	2.10	1.35
Chainsaw operational costs	3.00	3.00	3.00
Salary	50.00	50.00	50.00
	(59.20)	(55.10)	(54.35)

Winching costs

Equipment depreciation	13.40	5.00	3.95
Tractor, operational costs	3.00	3.00	3.00
Salary	12.50	12.50	12.50
	(28.90)	(20.50)	(19.45)

Forwarding costs

	17.00	17.00	17.00
	105.10	92.60	90.80

Man-day requirements (excluding forwarding)

Felling	17	67	134
Winching	4	17	34

Note: m³= cubic metre solid volume

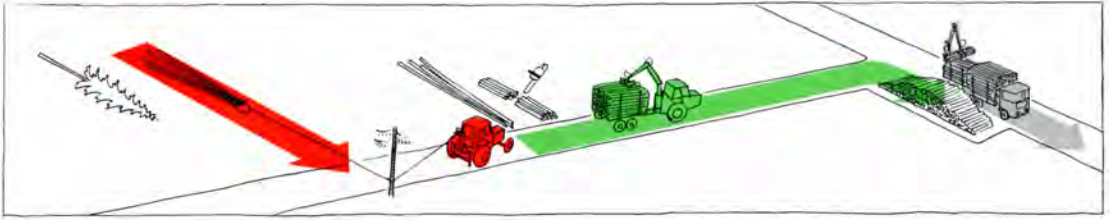

Method II

Tree length or tree sections to trail

Felling production: 1 m³/hour

Average winch distance: 25 m

Winch production: 5 m³/hour

Forwarding distance (transport to truck road): 250 m

Forwarding cost: 17 SEK/m³

Equipment: Chainsaw, forestry equipped farm tractor, winch remote control line, skid pan, chokers, hand tools

Equipment costs (excluding tractor): 11,240 SEK

Operating costs: Farm tractor 12 SEK/hour

Chainsaw 3 SEK/hour

Salary costs: (including fringe benefits payable by the operator): 50 SEK/hour

Work hours per day: 6

	Costs SEK/m ³ for an annual harvest of:		
	100 m ³	200 m ³	800 m ³
Felling costs			
Chainsaw depreciation	6.20	2.10	1.35
Chainsaw operational costs	3.00	3.00	3.00
Salary	50.00	50.00	50.00
	(59.20)	(55.10)	(54.35)
Winching costs			
Equipment depreciation	13.90	5.20	4.05
Tractor operational costs	2.40	2.40	2.40
Salary	10.00	10.00	10.00
	26.30	17.60	16.45
Forwarding costs			
	17.00	17.00	17.00
	102.50	89.70	87.80
Man-day requirements			
Felling	17	67	134
Winching	4	14	27

Note: m³=cubic metre solid volume

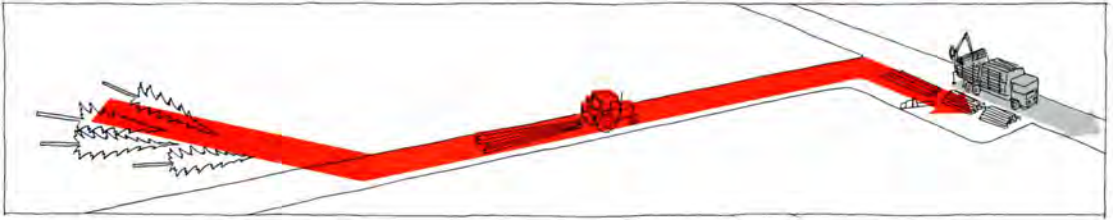

Method III

Tree length to landing

Felling production: 1 m³/hour

Transport skidding distance: 250 m

Transport production (winching and skidding): 2 m³/hour

Equipment: Chainsaw, forestry equipped farm tractor, winch, remote control line, chokers, hand tools

Equipment costs (excluding tractor): 10,280 SEK

Operating costs: Farm tractor 12 SEK/hour

Chainsaw 3 SEK/hour

Salary costs: (including fringe benefits payable by the operator): 50 SEK/hour

Work hours per day: 6

	Cost SEK/m ³ for an annual harvest of		
	100 m ³	400 m ³	800 m ³
Felling costs			
Chainsaw depreciation	6.20	2.10	1.35
Chainsaw operational costs	3.00	3.00	3.00
Salary	50.00	50.00	50.00
	(59.20)	(55.10)	(54.35)
Transport costs (winching, skidding)			
Equipment depreciation	12.70	4.50	3.15
Tractor operational costs	6.00	6.00	6.00
Salary	25.00	25.00	25.00
	(43.70)	(35.50)	(34.15)
Total	102.90	90.60	88.50
Man-day requirements			
Felling	17	67	134
Transport (winching+skidding)	9	34	67

Note: m³=cubic metre solid volume

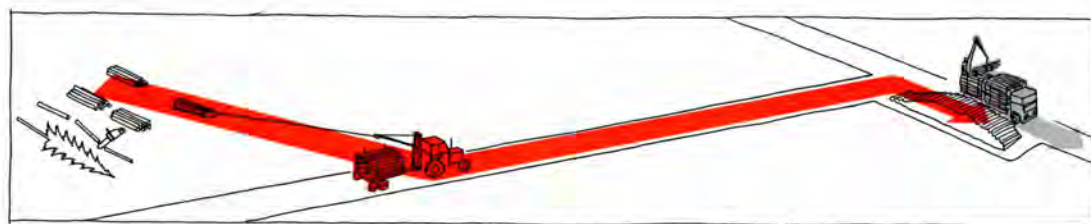

Method IV

Shortwood to landing (truck road)

Felling production: 1 m³/hour

Transport distance: 250 m

Transport production: 2.5 m³/hour

Equipment: Chainsaw, forestry equipped tractor, crane, trailer, dump beam, remote control line, skid pan, load straps (chains), binders, hand tools

Equipment costs (excluding tractor): 19,390 SEK

Operating costs: Farm tractor 12 SEK/hour

Chainsaw 3 SEK/hour

Salary costs: (including fringe benefits payable by the operator): 50 SEK

Work hours per day: 6

	Costs SEK/m ³ for an annual harvest of:		
	100 m ³	200 m ³	400 m ³

Felling costs

Chainsaw depreciation	6.20	2.10	1.35
Chainsaw operating costs	3.00	3.00	3.00
Salary	50.00	50.00	50.00
	(59.20)	(55.10)	(54.35)

Transport costs (winching, forwarding)

Equipment depreciation	24.25	8.90	6.40
Tractor operating costs	4.80	4.80	4.80
Salary	20.00	20.00	20.00
	(49.05)	(33.70)	(31.20)

Total	108.25	88.80	85.55
--------------	---------------	--------------	--------------

Man-day requirements

Felling	17	67	134
Transport	7	27	54

This equipment is more versatile than the equipment used in Methods I-III. You can, for instance, use the crane to load other items like cement pipes, fertilizers, etc.

Note: M³=cubice metre solid volume

**On the next page you can make
your own calculations using your
figures and conditions.**

Make your own calculations

To get an appreciation of your own harvesting costs you should make your own calculations, based on your own situation and costs.

The costs that you should include are:

Machine and equipment costs, i.e., the depreciation costs for your equipment. Note that the depreciation costs for the tractor may not be included since these costs normally are already allocated to the farming sector of the enterprise. Depreciation costs for the farm tractor could be based on the different estimated uses of the tractor. Machine costs include the operating costs, i.e., gas, oil, repairs, etc.

Salary costs, i.e., your own or your employees remuneration for felling and transport work. In the cases where you employ a contractor for the transport from the strip road side to the truck road (forwarding) a contractor cost will be added. It is normally estimated as an amount per m³ taken out.

The depreciation costs per year can be obtained from the table below. Estimate a reasonable write off time, in years, then identify the depreciation factor and multiply the purchase price with the factor. This will give you the annual depreciation costs.

By dividing the annual depreciation costs by the estimated annual harvesting volume you will get the depreciation costs per m³ solid volume.

Depreciation factors for a 10 % interest level.

Years to depreciate	Depreciation factor
1	1.10000
2	0.57619
3	0.40211
4	0.31547
5	0.26380
6	0.22961
7	0.20541
8	0.18744
9	0.17364
10	0.16275
11	0.15396
12	0.14676
13	0.14078
14	0.13575
15	0.13147

Example of equipment costs

Price level: 1982

Interest: 10 %

Depreciation time and depreciation costs:

Equipment	Purchase Price	Depreciation time and costs for an annual harvest of					
		100 m ³ solid		400 m ³ solid		800 m ³ solid	
		Year	SEK m ³	Year	SEK m ³	Year	SEK m ³
Forestry attach. for tractor	2,300	10	3.70	6	1.30	4	0.90
Winch	3,900	10	6.30	6	2.20	4	1.50
Skid pan (glass fibre)	660	8	1.20	3	0.70	1	0.90
Wire crane (loader)	4,500	10	7.30	6	2.60	4	1.80
Remote control line	680	10	1.10	6	0.40	4	0.30
Trailer (5 ton)	7,000	15	9.20	8	3.30	6	2.00
Chokers	300	10	0.50	6	0.20	4	0.10
Dump beam	400	10	0.65	6	0.20	4	0.15
Hand tools	700	10	1.10	6	0.40	3	0.35
Chainsaw	2,700	6	6.20	4	2.10	3	1.35

No depreciation is calculated on the farm tractor here since it is expected to be used primarily in agriculture work.

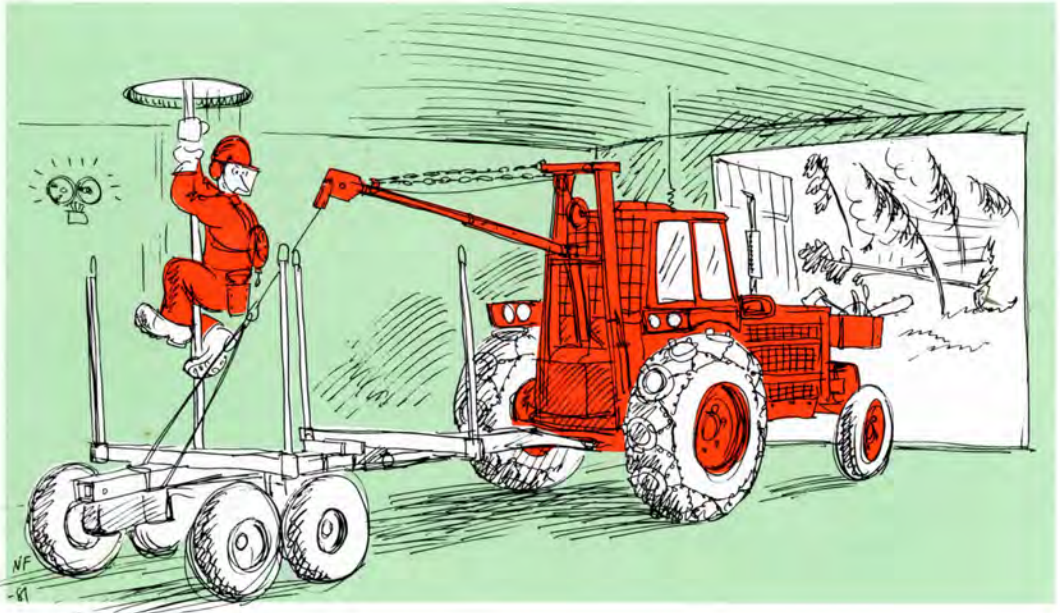

You and your logging equipment represent valuable assets which are available on demand. In case of storm damage you will be able to quickly harvest damaged trees and reduce the danger of insect attack or losses due to rot. Should good prices occur for specific items your resources can quickly be put to work to take advantage of the opportunities.

This series of handbooks for woodlots includes:

The Chainsaw Use and Maintenance

Translated to English, French, Spanish, Dutch and Finnish.

The Farm Tractor in the Forest

Translated to English, French and German.

The handbooks, except for the Dutch translation, can be ordered from:

The National Board of Forestry
S-551 83 JÖNKÖPING
SWEDEN

For North America the handbooks translated to English and French can also be ordered from:

Forest Extension Service
N.B. Department of National Resources
R.R. # 5
Fredricton, N.B.
CANADA E3B 4X6

The farm tractor in the forest

The tractor and its equipment



Power take-off shafts



Trailers



Winches

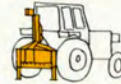

Cranes



Aids



Cables



Control and maintenance



Driving technique



Planning



Logging methods



Economy



ISBN 91-85748-25-0



Skogsstyrelsen
The National
Board of Forestry,
Sweden