

# STATE OF MAINE DEPARTMENT OF TRANSPORTATION



## DEXTER PENOBSCOT ROUTE 7

**FEDERAL AID PROJECT STP-1824(600)**  
PROJECT LENGTH : 1.64 MILES

PLAN LEGEND	
Town, County, State	Centerline-Existing
Property Lines	Centerline-Proposed
R/W Lines-Existing	Travelway-Existing
R/W Lines-Proposed	Travelway-Proposed
Culvert-Existing	Railroad
Culvert Proposed	Catch Basins
Curbing	Manholes
Type 1	Proposed Underdrain
Type 3	Proposed Ditch
Type 5	Existing Ditch
Outline of Bodies of Water	Utility Poles
Ledge	Fire Hydrants
Buildings	Existing Water Line
Trees	Existing San. Sewer
Tree Line	Existing San. Sewer Manhole
Clearing Limit Line	Guardrail-Existing
	Guardrail-Proposed
	Guardrail-Cable, Other

INDEX OF SHEETS	
Description	Sheet No.
Title Sheet	1
Typical Sections	2
Estimated Quantities	3
Drainage Sheet	4
Construction Notes	5
Plan / Profile	7-33
Geometric Curb Layout	X
Cross - Sections	34-141
Right of Way Map	X

### SAMPLE PLAN SET

#### MILESTONE: PRELIMINARY DESIGN REPORT COMPLETE

THIS SAMPLE PLAN SET REPRESENTS A TYPICAL URBAN, FULL RECONSTRUCTION PROJECT PLAN SET AT THE LEVEL OF DETAIL EXPECTED AT THIS MILESTONE.

IT IS INTENDED TO PROVIDE GUIDANCE IN WHAT LEVEL OF DETAIL AND WHAT TYPE OF INFORMATION IS REQUIRED AT THIS MILESTONE.  
IT IS NOT INTENDED THAT EACH SET OF PLANS LOOK EXACTLY LIKE THIS ONE.

**NOTE:**

THE TYPICAL SECTIONS AND THE CROSS SECTIONS SHOW A VERTICAL LINE AT THE BREAK BETWEEN 2% AND 4%. AS LONG AS THE TYPICAL SECTIONS ARE CLEARLY LABELED, THIS LINE COULD BE LOCATED AS SHOWN, AT THE EDGE OF TRAVELWAY OFFSET, OR NOT AT ALL. IT IS IMPORTANT TO REMEMBER THAT THE TRAVELWAY WIDTH IS DEFINED BY THE STRIPE LOCATION - THEREFORE IF THE SHOULDER BREAK IS AT A DIFFERENT OFFSET THAN THE EDGE OF TRAVELWAY, THE LINE DISPLAYED IN PLANVIEW SHOULD BE AT THE EDGE OF TRAVELWAY.

TRAFFIC DATA	Route 7 0.13 mile SE/O Fay Ct	Route 7/23 NE/O Route 23
Current (2015) AADT	7980	5230
Future (2035) AADT	9580	6280
DHV - % of AADT	10	10
Design Hour Volume	958	628
% Heavy Trucks (AADT)	8	7
% Heavy Trucks (DHV)	8	7
Directional Distribution (DHV)	54	51
18 kip Equivalent P 2.0	370	315
18 kip Equivalent P 2.5	352	300
Design Speed (mph)	25	25
Functional Class:	minor arterial	minor arterial

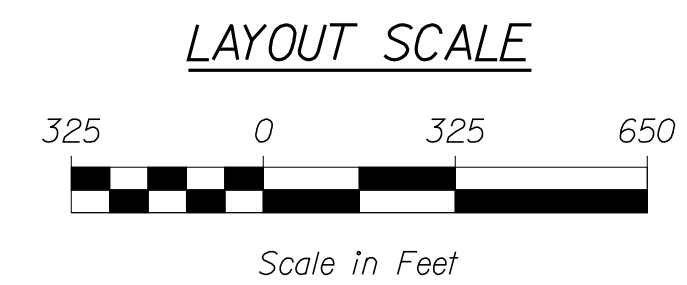

<b>PROJECT LOCATION:</b>	BEGINNING 0.10 OF A MILE NORTHERLY OF MECHANIC STREET AND EXTENDING NORTHERLY 1.64 MILES
<b>PROGRAM AREA:</b>	HIGHWAY
<b>SCOPE OF WORK:</b>	RECONSTRUCTION AND MILL & FILL

WIN 18246.00 018246.00

STATE OF MAINE DEPARTMENT OF TRANSPORTATION	APPROVED	DATE
SIGNATURE	P.E. NUMBER	DATE
PROGRAM	PROJECT MANAGER	DESIGNER
CONSULTANT	PROJECT RESIDENT	CONTRACTOR
PROJECT INFORMATION	PROJECT COMPLETION DATE	
DEXTER ROUTE 7		
TITLE SHEET		
SHEET NUMBER		
1		
OF 15		

Filename: ... \001\_Title.dgn  
Division: HIGHWAY  
Username: Alee.Mousseau  
Date: 5/19/2014

Date: 5/19/2014

Username: Ailee.Mousseau

Division: HIGHWAY

Filename: ... \002\_Typical.dgn

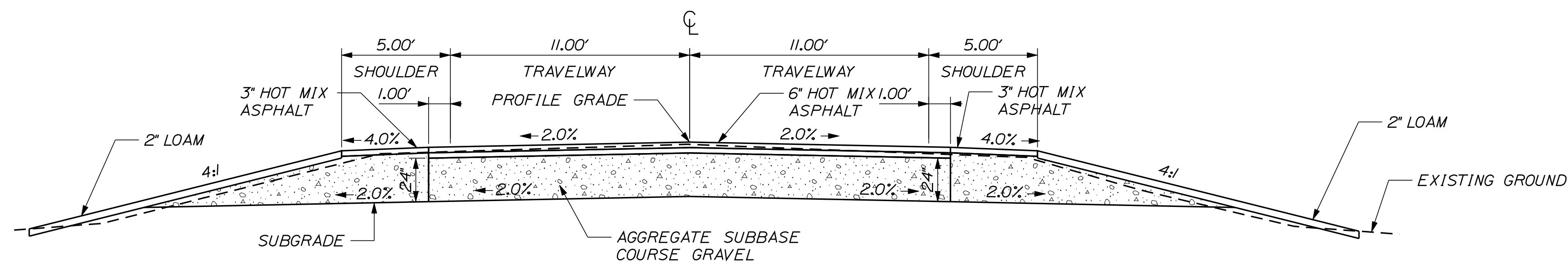

FULL CONSTRUCTION OPEN

AGGREGATE SUBBASE COURSE GRAVEL		
LEFT SHOULDER	11 FT. TRAVEL LANES	RIGHT SHOULDER
STATION TO STATION	STATION TO STATION	STATION TO STATION
12+50 TO 14+25 LT	12+50 TO 14+25	12+50 TO 14+25 RT

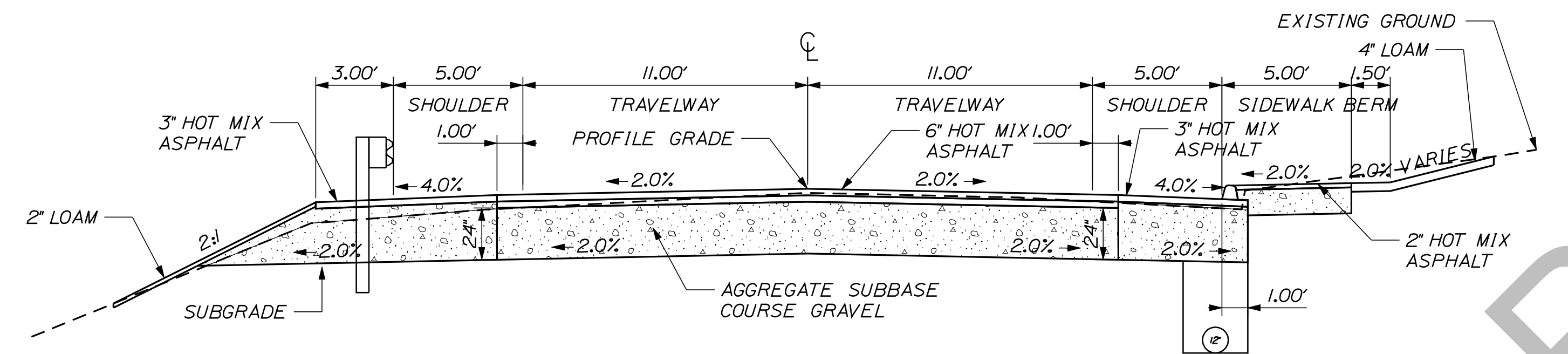

FULL CONSTRUCTION GUARDRAIL LEFT

AGGREGATE SUBBASE COURSE GRAVEL		
LEFT SHOULDER	11 FT. TRAVEL LANES	RIGHT SHOULDER
STATION TO STATION	STATION TO STATION	STATION TO STATION
68+50 TO 71+50 LT	68+50 TO 71+50	68+50 TO 71+50 RT

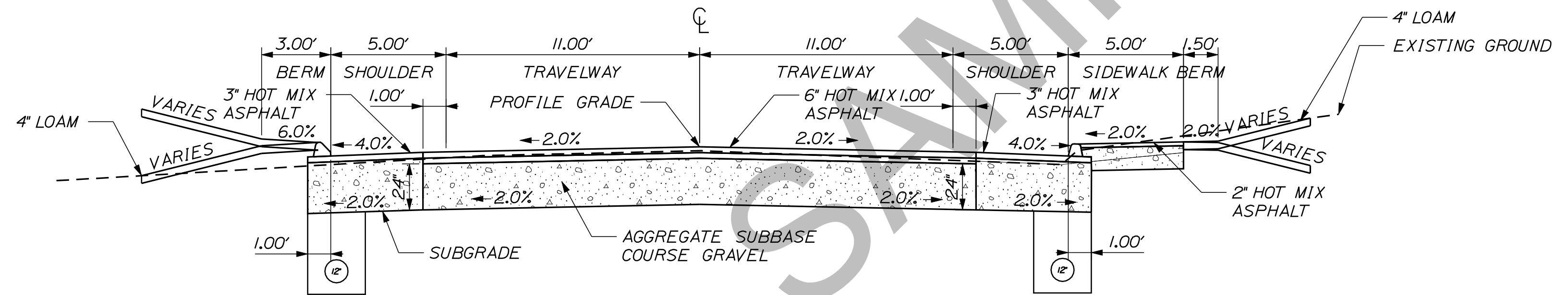

FULL CONSTRUCTION W/SIDEWALK

AGGREGATE SUBBASE COURSE GRAVEL		
LEFT/RIGHT SHOULDER	11 FT. TRAVEL LANES	RIGHT SHOULDER
STATION TO STATION	STATION TO STATION	STATION TO STATION
14+25 TO 26+33 LT & RT	14+25 TO 26+33	
26+33 TO 68+50 LT	26+33 TO 68+50	26+33 TO 68+50 RT
71+50 TO 87+50 LT	71+50 TO 87+50	71+50 TO 87+50 RT

LT. SHOULDER	LT TRAVELWAY	STATION	RT TRAVELWAY	RT. SHOULDER
MATCH	MATCH	11+50	MATCH	MATCH
-4	-2	12+50	-2	-4
-4	-2	87+00	-2	-4
MATCH	MATCH	87+50	MATCH	MATCH
		END		

NOTE:

1. THE PAVEMENT, BASE AND SUBBASE DEPTHS AS SHOWN ON THE PLANS ARE INTENDED TO BE NOMINAL.
2. WHEN SUPERELEVATION EXCEEDS THE SLOPE OF THE LOW SIDE SHOULDER, THE LOW SIDE SHOULDER SHALL HAVE THE SAME SLOPE AS THE TRAVELWAY.
3. CROWNS FOR BOTH NORMAL AND SUPERELEVATION SECTIONS FOR ALL COURSES OF SUBBASE AND PAVEMENT SHALL BE STRAIGHT.
4. THE GRAVEL QUANTITY CALCULATION IS BASED ON A 2" LOAM OR DIRTY BORROW DEPTH. THE ACTUAL DEPTH MAY VARY. SEE THE GENERAL NOTES.
5. THE ALGEBRAIC DIFFERENCE BETWEEN THE SHOULDER AND TRAVELWAY CROSS SLOPES "ROLLOVER" SHALL NOT EXCEED 8%.
6. THE STATIONING SHOWN UNDER EACH TYPICAL IS APPROXIMATE.

STATE OF MAINE DEPARTMENT OF TRANSPORTATION	018246.00	WIN 18246.00	HIGHWAY PLANS
SIGNATURE	P.E. NUMBER	DATE	
PROJ. MANAGER ERNEST MARTIN	BY TRAVIS WÖHEL	DATE	
DESIGN-DETAILED	DESIGN-REVIEWED	DESIGN-DATE	
DESIGN-DATE	REVISIONS 1	REVISIONS 2	REVISIONS 3
REVISIONS 1	REVISIONS 2	REVISIONS 3	REVISIONS 4
REVISIONS 2	REVISIONS 3	REVISIONS 4	FIELD CHANGES
DEXTER ROUTE 7		TYPICAL SECTIONS	
SHEET NUMBER			
2			
NOT TO SCALE			
OF 15			

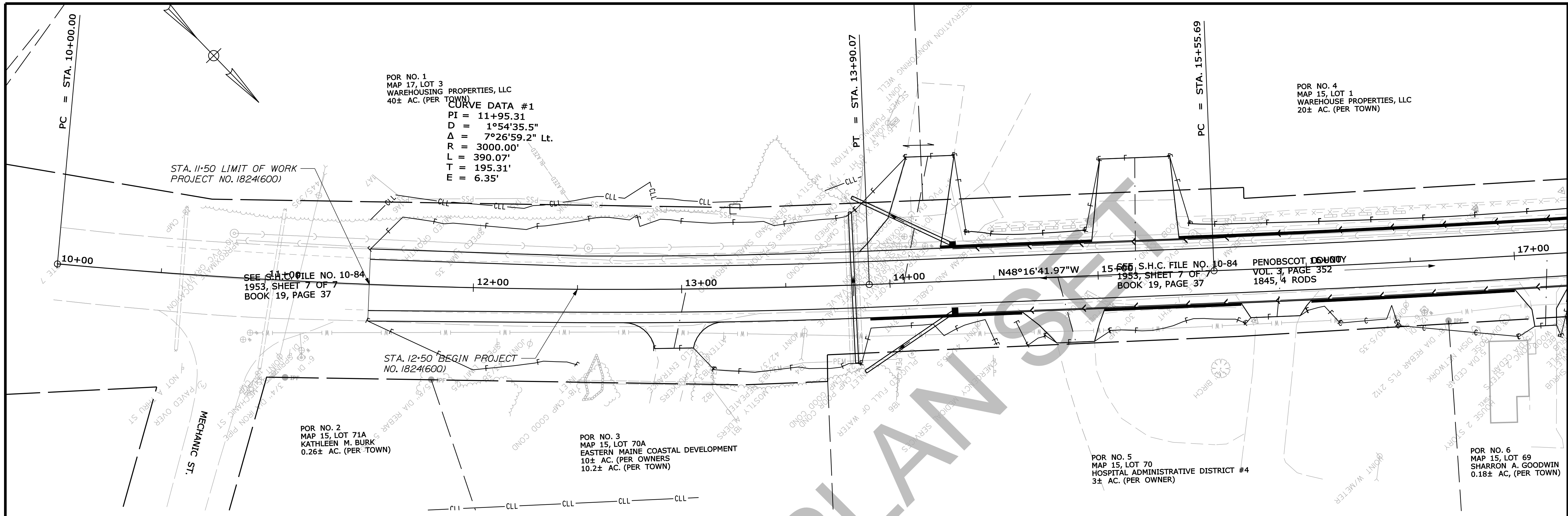

POR NO. 1  
MAP 17, LOT 3  
WAREHOUSING PROPERTIES, LLC  
40± AC. (PER TOWN)

**CURVE DATA #1**  
PI = 11+95.31  
D = 1°54'35.5"  
Δ = 7°26'59.2" Lt.  
R = 3000.00'  
L = 390.07'  
T = 195.31'  
E = 6.35'

POR NO. 4  
MAP 15, LOT 1  
WAREHOUSE PROPERTIES, LLC  
20± AC. (PER TOWN)

POR NO. 2  
MAP 15, LOT 71A  
KATHLEEN M. BURK  
0.26± AC. (PER TOWN)

POR NO. 3  
MAP 15, LOT 70A  
EASTERN MAINE COASTAL DEVELOPMENT  
10± AC. (PER OWNERS)  
10.2± AC. (PER TOWN)

POR NO. 5  
MAP 15, LOT 70  
HOSPITAL ADMINISTRATIVE DISTRICT #4  
3± AC. (PER OWNER)

POR NO. 6  
MAP 15, LOT 69  
SHARRON A. GOODWIN  
0.18± AC. (PER TOWN)

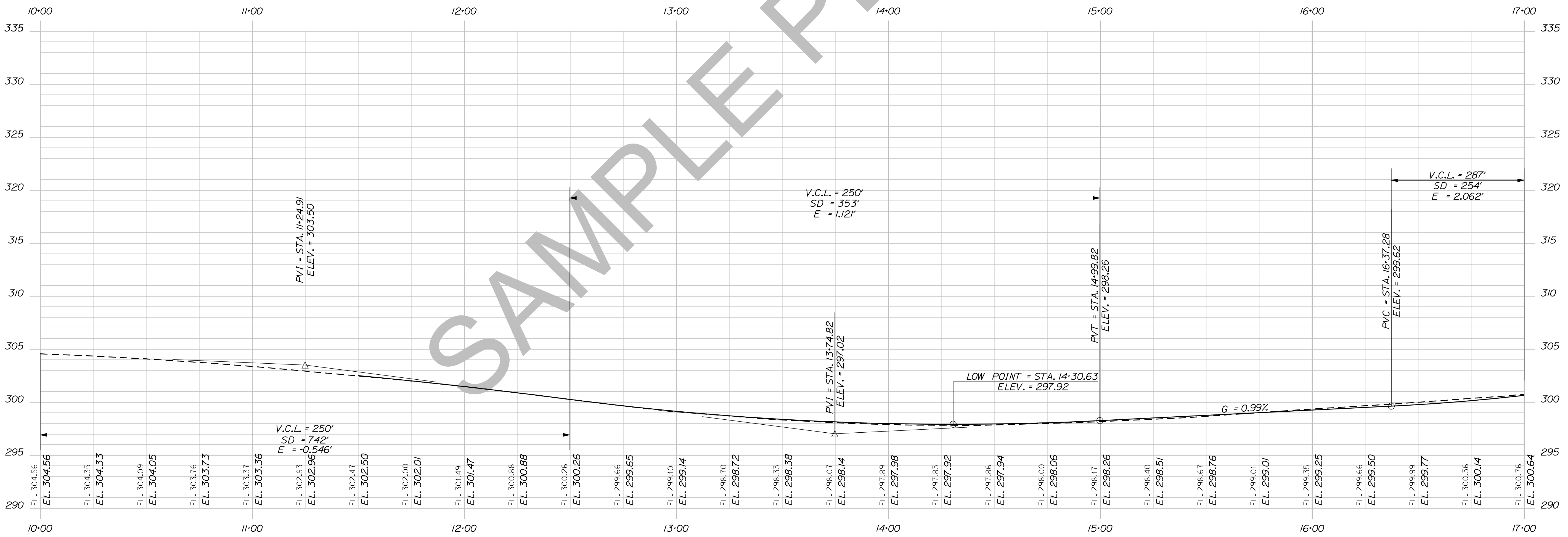

PROFILE

STATE OF MAINE  
DEPARTMENT OF TRANSPORTATION  
018246-00  
WIN  
18246.00  
HIGHWAY PLANS

BY	DATE	SIGNATURE	P.E. NUMBER	DATE
PROJ. MANAGER	ERNEST MARTIN			
DESIGN-DETAILED	TRAVIS WOLFE			
CHECKED-REVIEWED				
DESIGN-DETAILED				
DESIGN-DETAILED				
REVISIONS 1				
REVISIONS 2				
REVISIONS 3				
REVISIONS 4				
FIELD CHANGES				

DEXTER  
ROUTE 7  
PLANS

SHEET NUMBER  
7  
OF 15



Date: 5/19/2014

Username: Allee, Mousseu

Division: HIGHWAY

Filename: ... \008\_HDPLAN.DGN

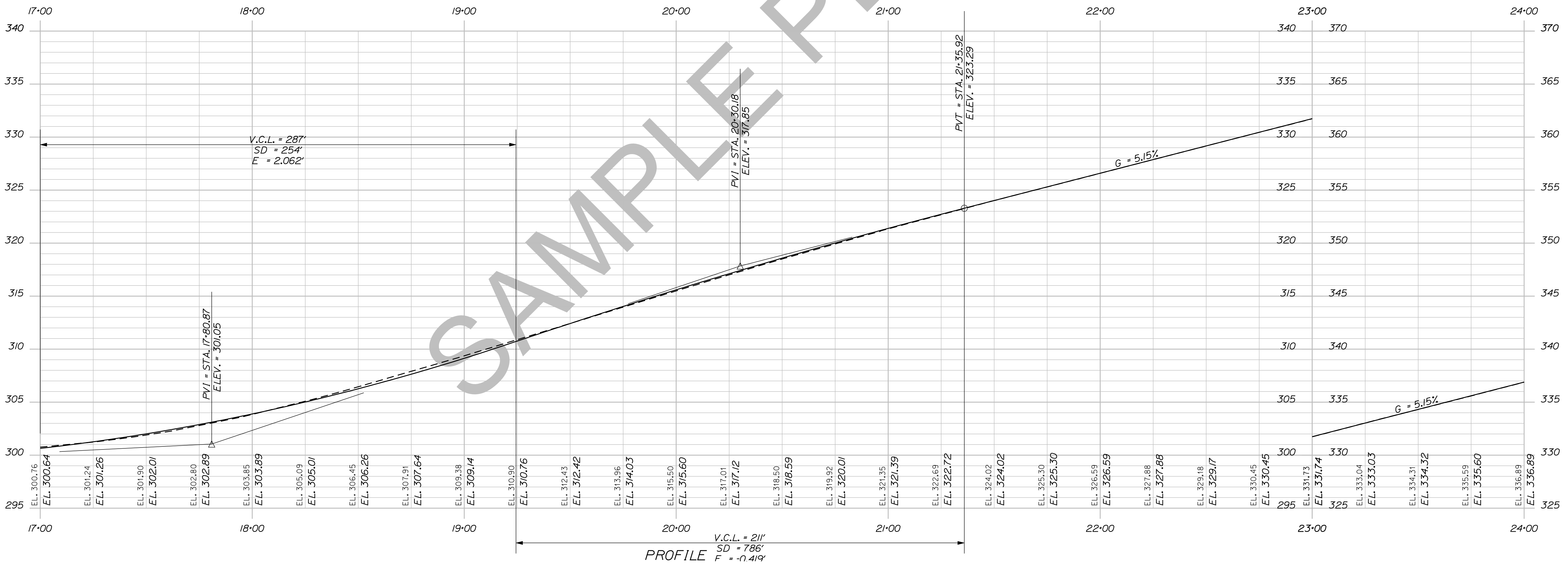
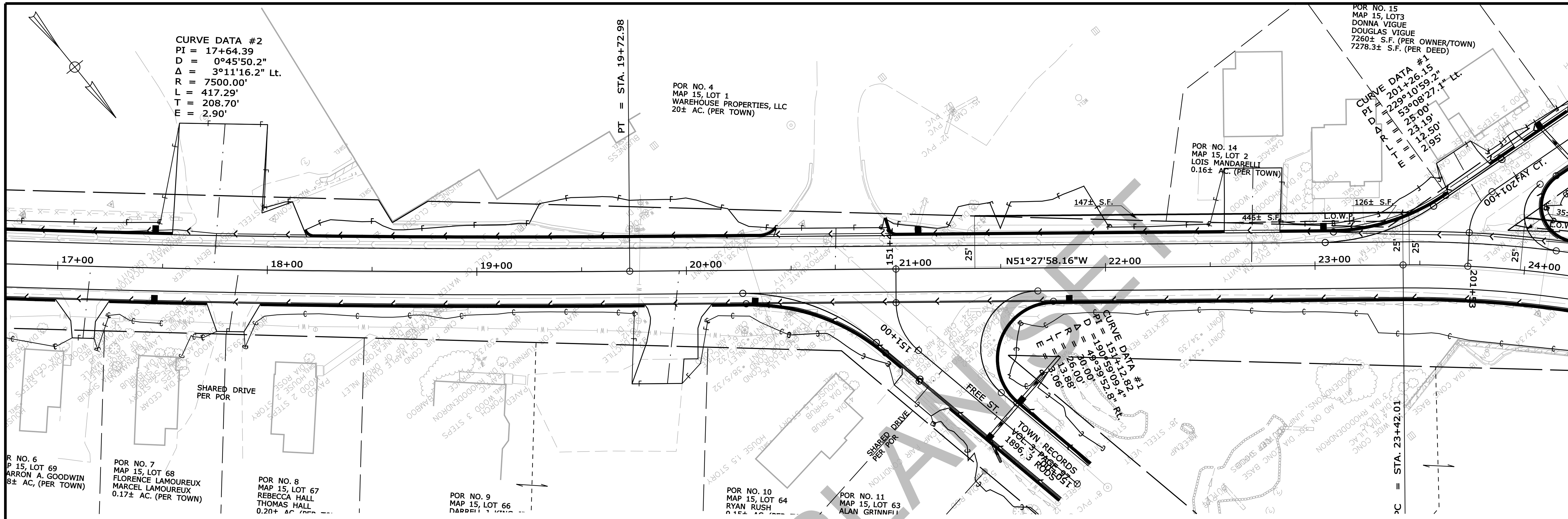

STATE OF MAINE		DEPARTMENT OF TRANSPORTATION		018246.00		WIN		HIGHWAY PLANS	
PROJECT		SIGNATURE		P.E. NUMBER		DATE		FIELD CHANGES	
PROJ. MANAGER	ERNEST MARTIN	BY	DATE	DESIGN-REVIEWED	TRAVIS WOLFE	DESIGN-REVIEWED	DATE	REVISIONS 1	
CHECKED				DESIGN-REVIEWED		DESIGN-REVIEWED		REVISIONS 2	
				DESIGN-REVIEWED		DESIGN-REVIEWED		REVISIONS 3	
				DESIGN-REVIEWED		DESIGN-REVIEWED		REVISIONS 4	
Dexter		Route 7		Plans		SHEET NUMBER		8	
								OF 15	



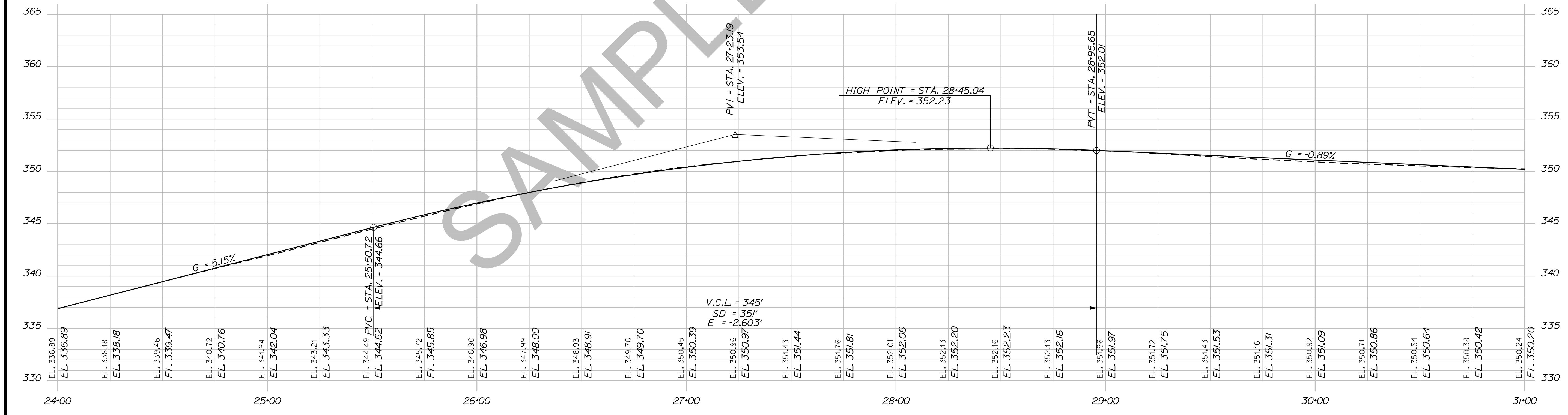
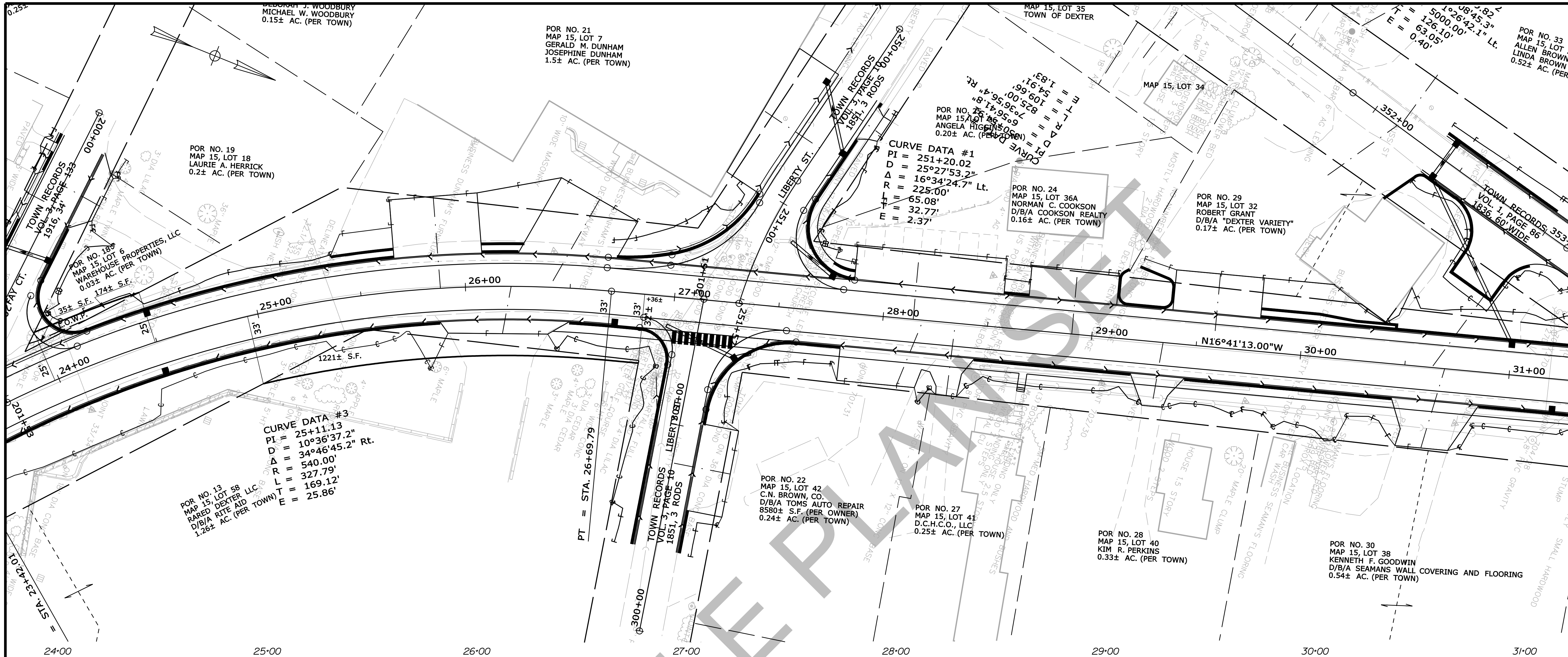

STATE OF MAINE  
 DEPARTMENT OF TRANSPORTATION  
 018246.00  
 WIN  
 18246.00  
 HIGHWAY PLANS

PROJ. MGR.	DATE	BY	DATE
ERNEST MARTIN		TRAVIS WOLFE	

DESIGN/REVIEWED	SIGNATURE
DESIGN DETAILED	
CHECKED	
DESIGN DETAILED	
DESIGN DETAILED	
REVISIONS 1	
REVISIONS 2	
REVISIONS 3	
REVISIONS 4	
FIELD CHANGES	

P.E. NUMBER	DATE

DEXTER  
 ROUTE 7  
 PLANS

SHEET NUMBER  
 9  
 OF 15

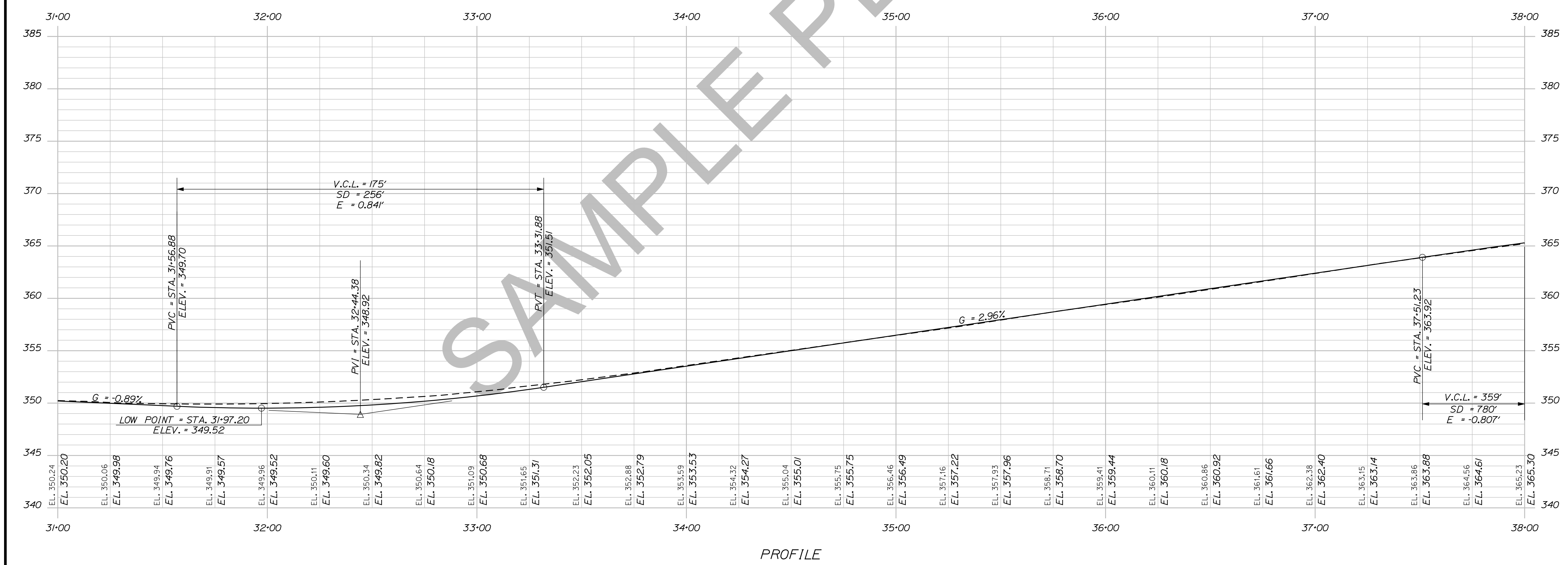
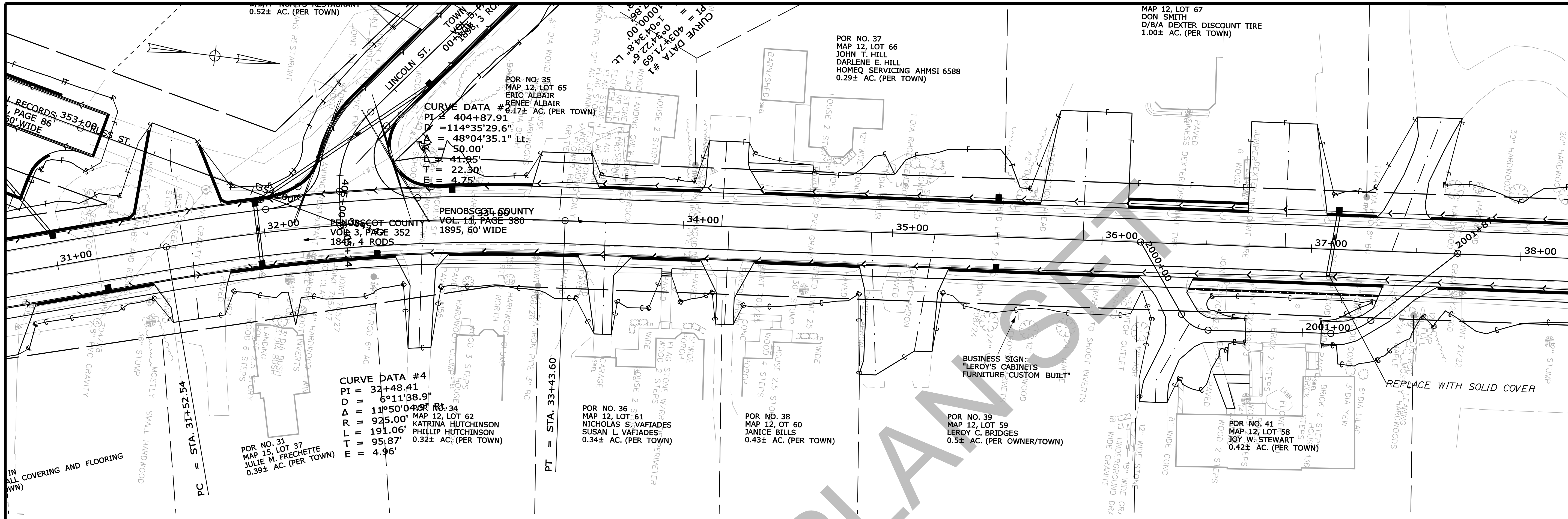

STATE OF MAINE		DEPARTMENT OF TRANSPORTATION		018246-00		WIN		18246.00		HIGHWAY PLANS	
PROJ. MANAGER	ERNEST MARTIN	BY	TRAVIS WOLFE	SIGNATURE		P.E. NUMBER		DATE			
DESIGN-DETAILED		CHECKED-REVIEWED		DESIGNS-DETAILED		REVISIONS 1		REVISIONS 2		REVISIONS 3	
						REVISIONS 4					
DEXTER ROUTE 7 PLANS											
SHEET NUMBER											
10											
OF 15											



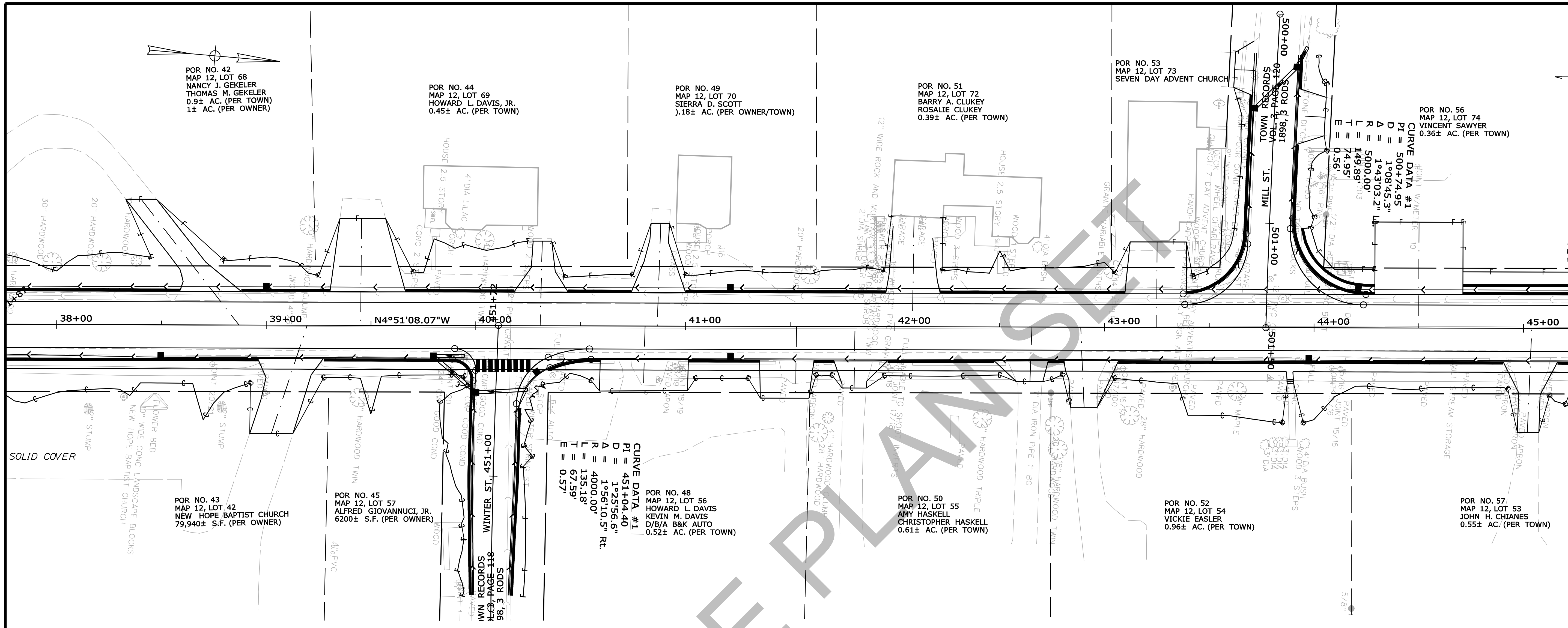

STA. 38+00.00 TO STA. 45+00.00

STATE OF MAINE		DEPARTMENT OF TRANSPORTATION		018246.00		WIN		18246.00		HIGHWAY PLANS	
DESIGN-DETAILED		CHECKED-REVIEWED		DESIGNS-DETAILED		REVISIONS 1		REVISIONS 2		REVISIONS 3	
DATE		BY		SIGNATURE		P.E. NUMBER		DATE		FIELD CHANGES	
TRAVIS WOLFE		ERNEST MARTIN									
ROUTE 7		SHEET NUMBER		11		OF 15		PLANS			



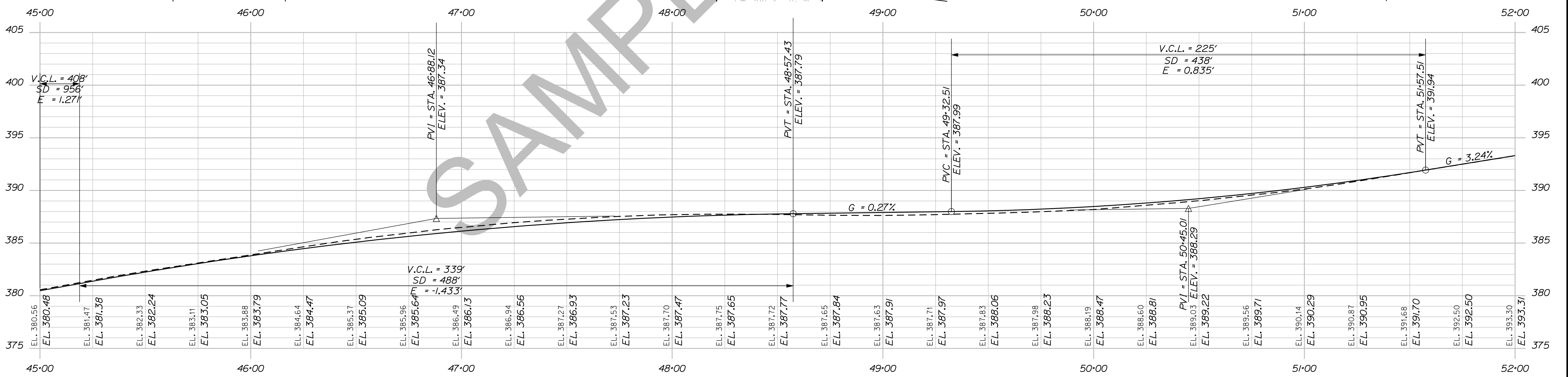
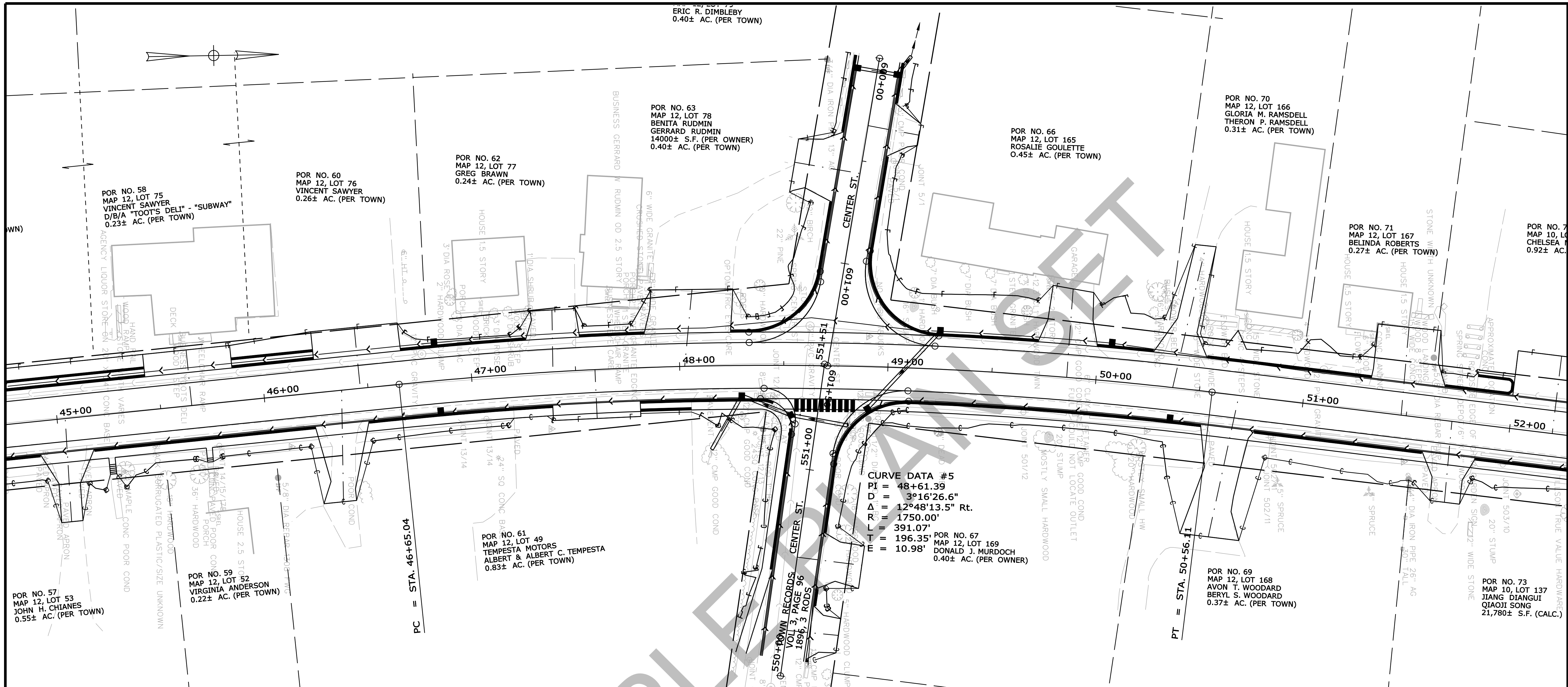

STATE OF MAINE		DEPARTMENT OF TRANSPORTATION	
018246.00		WIN	
18246.00		HIGHWAY PLANS	
PROJ. MANAGER	ERNEST MARTIN	BY	DATE
CHECKED/REVIEWED	TRAVIS WOLFE	SIGNATURE	
DESIGNED/DETAILED		P.E. NUMBER	
DESIGNED/DETAILED		DATE	
REVISIONS 1			
REVISIONS 2			
REVISIONS 3			
REVISIONS 4			
FIELD CHANGES			
DEXTER ROUTE 7 PLANS			
SHEET NUMBER			
12			
OF 15			

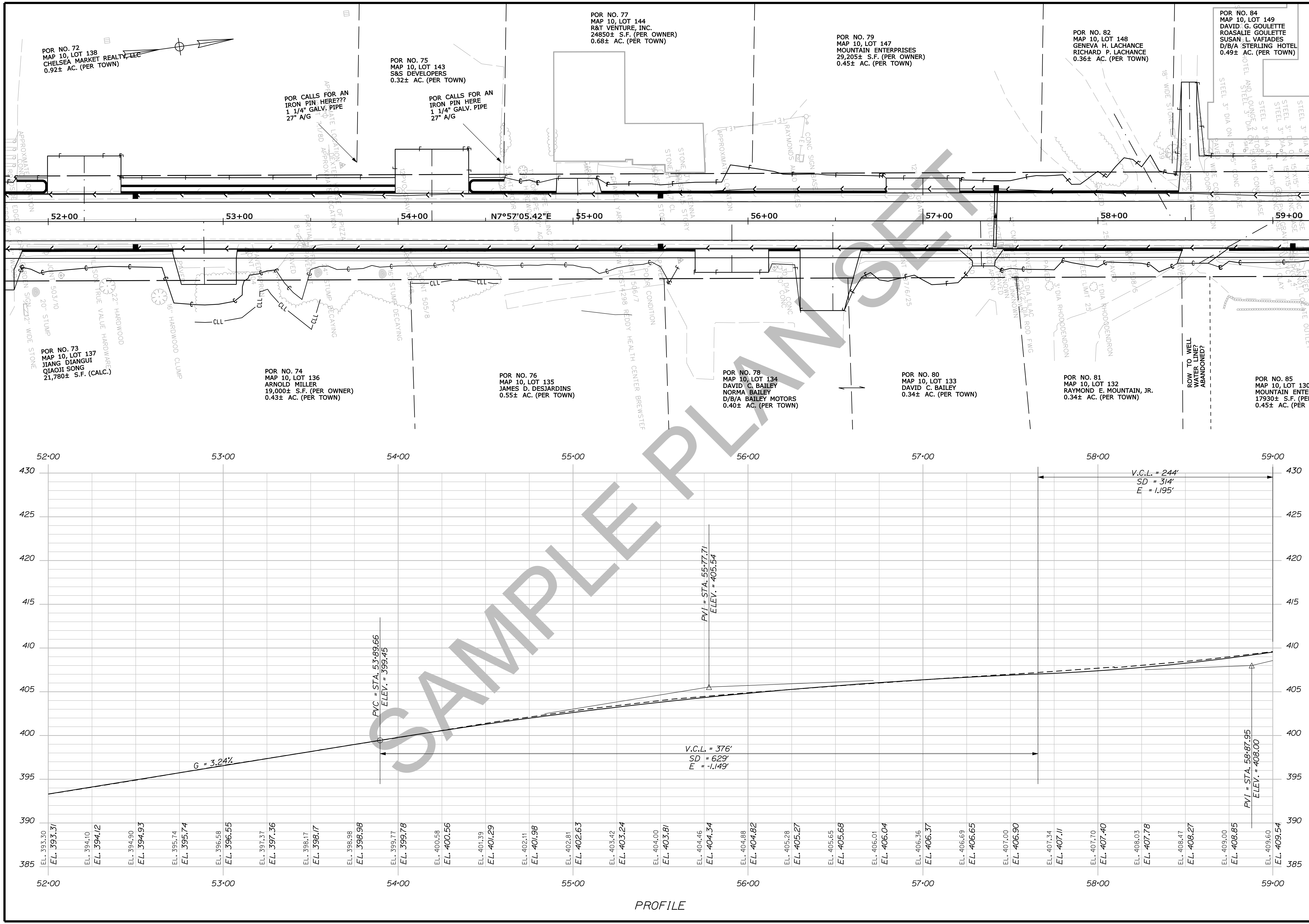

<b>STATE OF MAINE</b>	
<b>DEPARTMENT OF TRANSPORTATION</b>	
<b>018246.00</b>	<b>WIN</b>
<b>18246.00</b>	
<b>HIGHWAY PLANS</b>	
<b>DEXTER ROUTE 7</b>	<b>PLANS</b>
<b>SHEET NUMBER</b>	
<b>13</b>	
<b>OF 15</b>	

PROJ. MGR.	DATE	BY
ERNEST MARTIN		
TRAVIS WHEELER		

  

DESIGN	REVIEWED	SIGNATURE
DESIGNED	TRAVIS WHEELER	
CHECKED	TRAVIS WHEELER	
DESIGNED	TRAVIS WHEELER	
DESIGNED	TRAVIS WHEELER	
REVISIONS	1	
REVISIONS	2	
REVISIONS	3	
REVISIONS	4	
<b>FIELD CHANGES</b>		

DATE	DATE	DATE



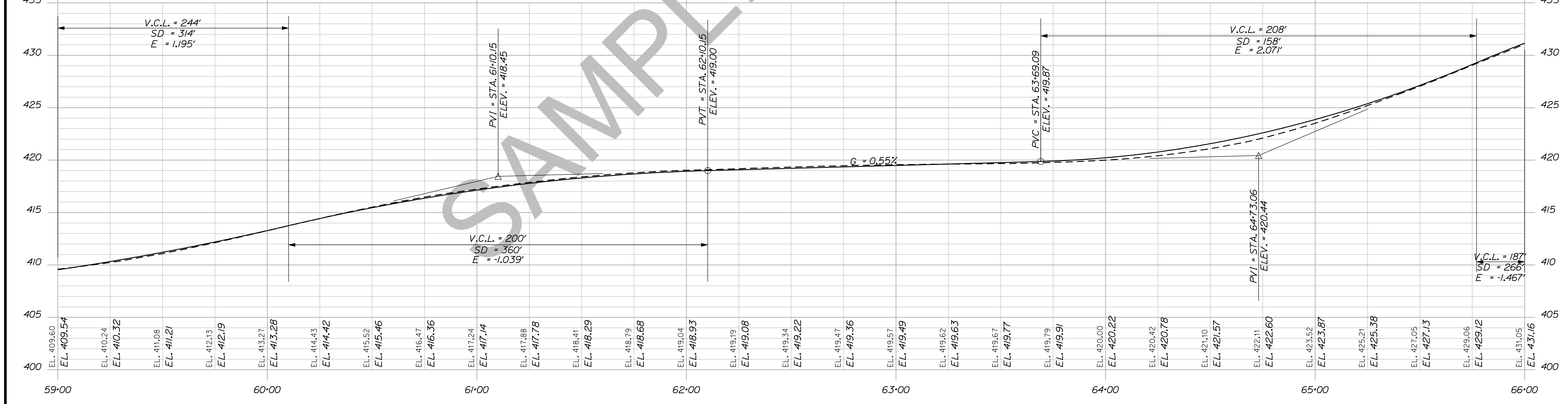
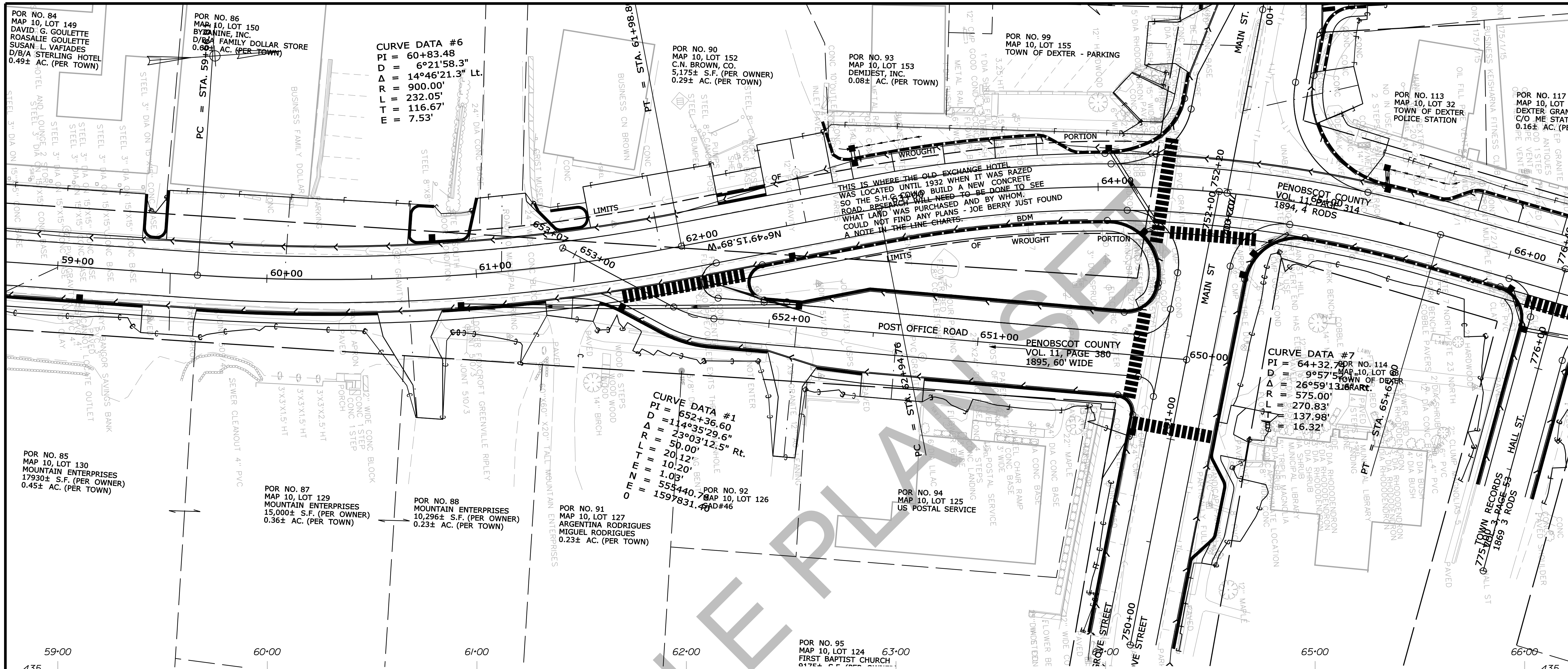

PROFILE STA. 59+00.00 TO STA. 66+00.00

STATE OF MAINE DEPARTMENT OF TRANSPORTATION		018246-00
DEPTER ROUTE 7 PLANS		WIN 18246.00 HIGHWAY PLANS
SHEET NUMBER	14	
OF 15		DATE
PROJ. MANAGER	ERNEST MARTIN	DATE
DESIGN-DETAILED	TRAVIS WOLFE	DATE
CHECKED-REVIEWED		DATE
DESIGN-DETAILED		DATE
DESIGN-DETAILED		DATE
REVISIONS 1		DATE
REVISIONS 2		DATE
REVISIONS 3		DATE
REVISIONS 4		DATE
FIELD CHANGES		DATE



Username: Ailee.Mousseau Date: 5/19/2014

Division: HIGHWAY

Filename: ... \015\_HDPLAN.DGN

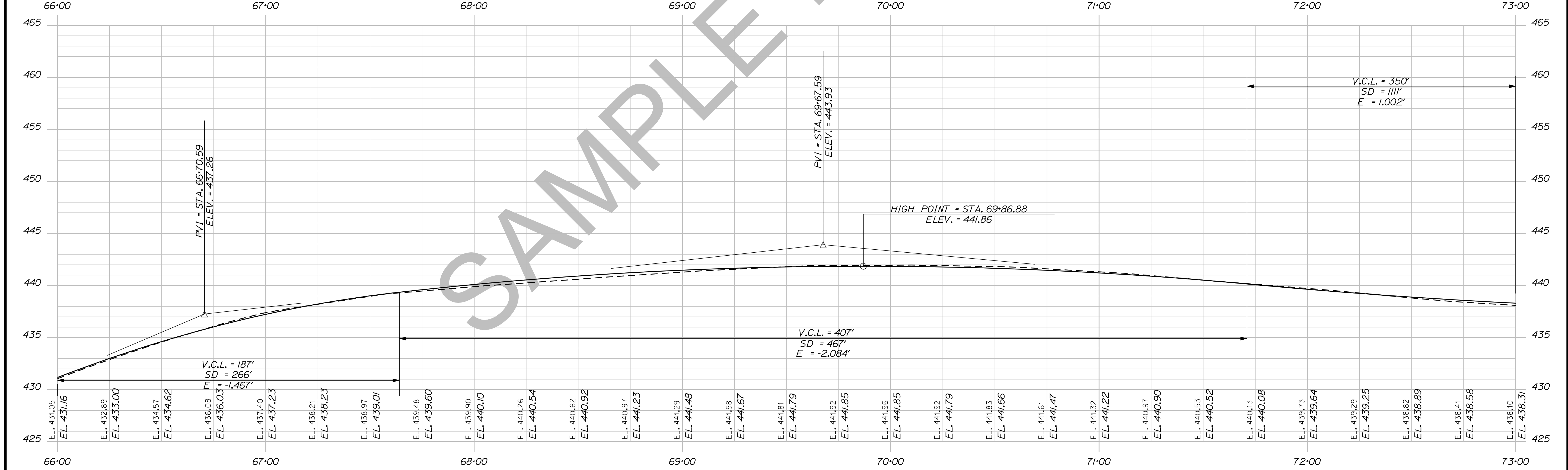
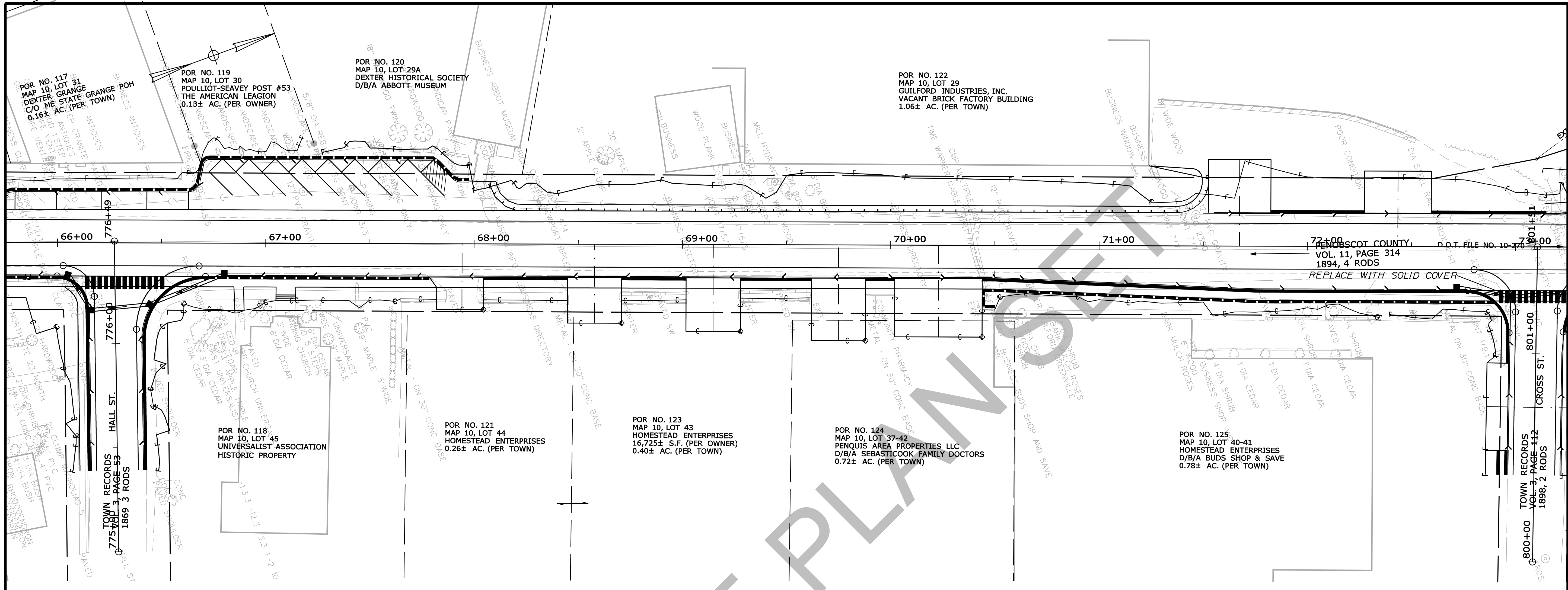

PROFILE

STA. 66+00.00 TO STA. 73+00.00

STATE OF MAINE  
DEPARTMENT OF TRANSPORTATION  
018246-00  
WIN  
18246.00  
HIGHWAY PLANS

DESIGN/REVIEW	DATE	SIGNATURE	P.E. NUMBER	DATE
PROJ. MANAGER	ERNEST MARTIN			
CHECKED/REVIEWED	TRAVIS WOLFE			
DESIGN/TAILED				
REVISIONS				
REVISIONS				
REVISIONS				
REVISIONS				
FIELD CHANGES				

DEXTER  
ROUTE 7  
PLANS

SHEET NUMBER  
**15**  
OF 15

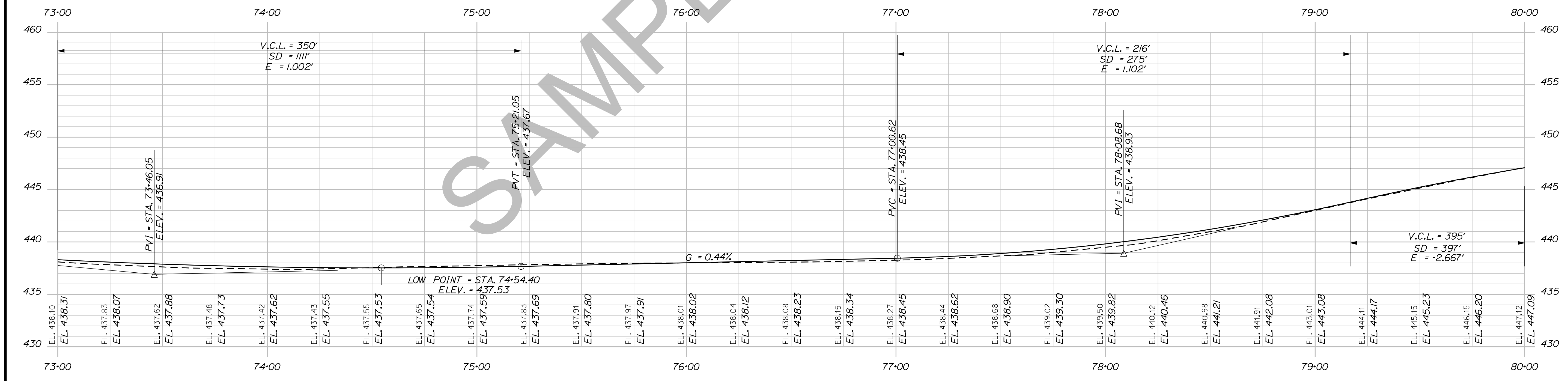
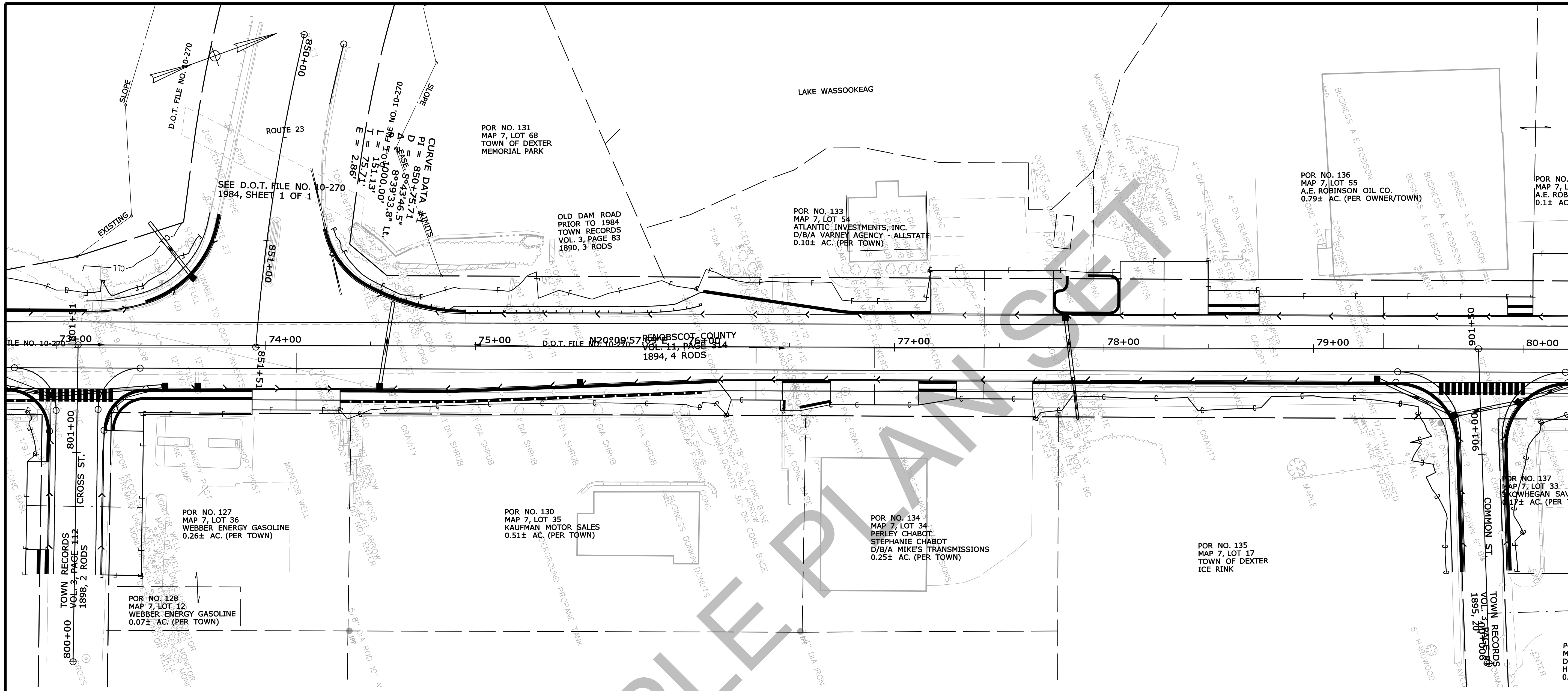

PROFILE

STATE OF MAINE	
DEPARTMENT OF TRANSPORTATION	
018246.00	WIN
18246.00	
HIGHWAY PLANS	
DEXTER ROUTE 7 PLANS	SHEET NUMBER <b>16</b> OF 15

PROJ. MGR.	DATE	BY	DATE
ERNEST MARTIN		TRAVIS WOLF	
DESIGN-DETAILED			
CHECKED-REVIEWED			
DESIGNS-DETAILED			
DESIGNS-DETAILED			
REVISIONS 1			
REVISIONS 2			
REVISIONS 3			
REVISIONS 4			
FIELD CHANGES			



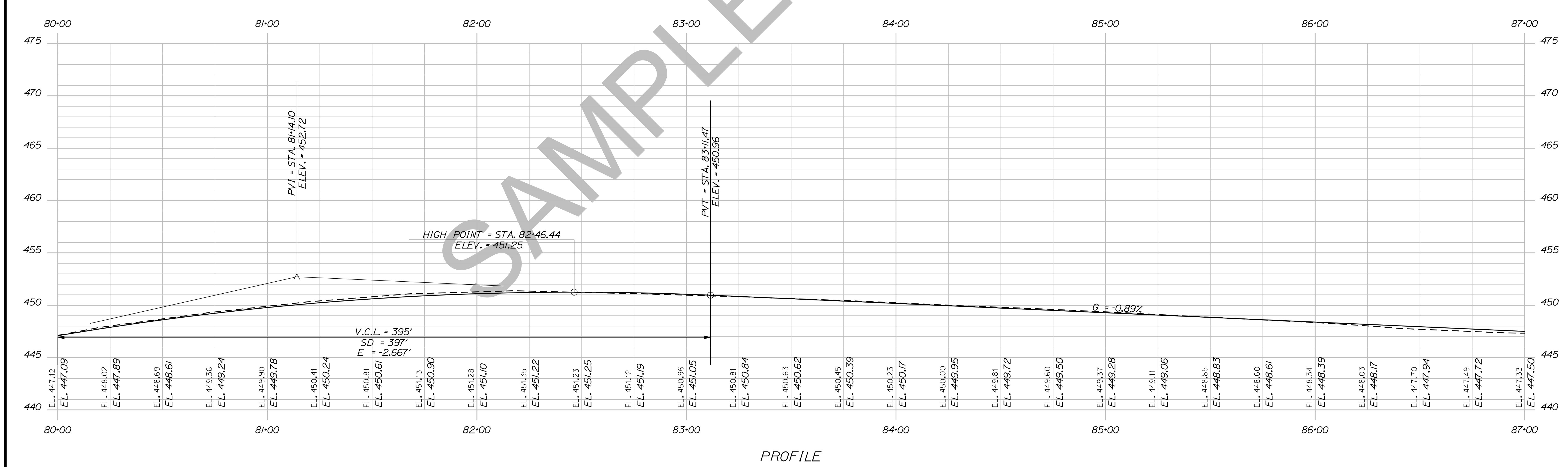
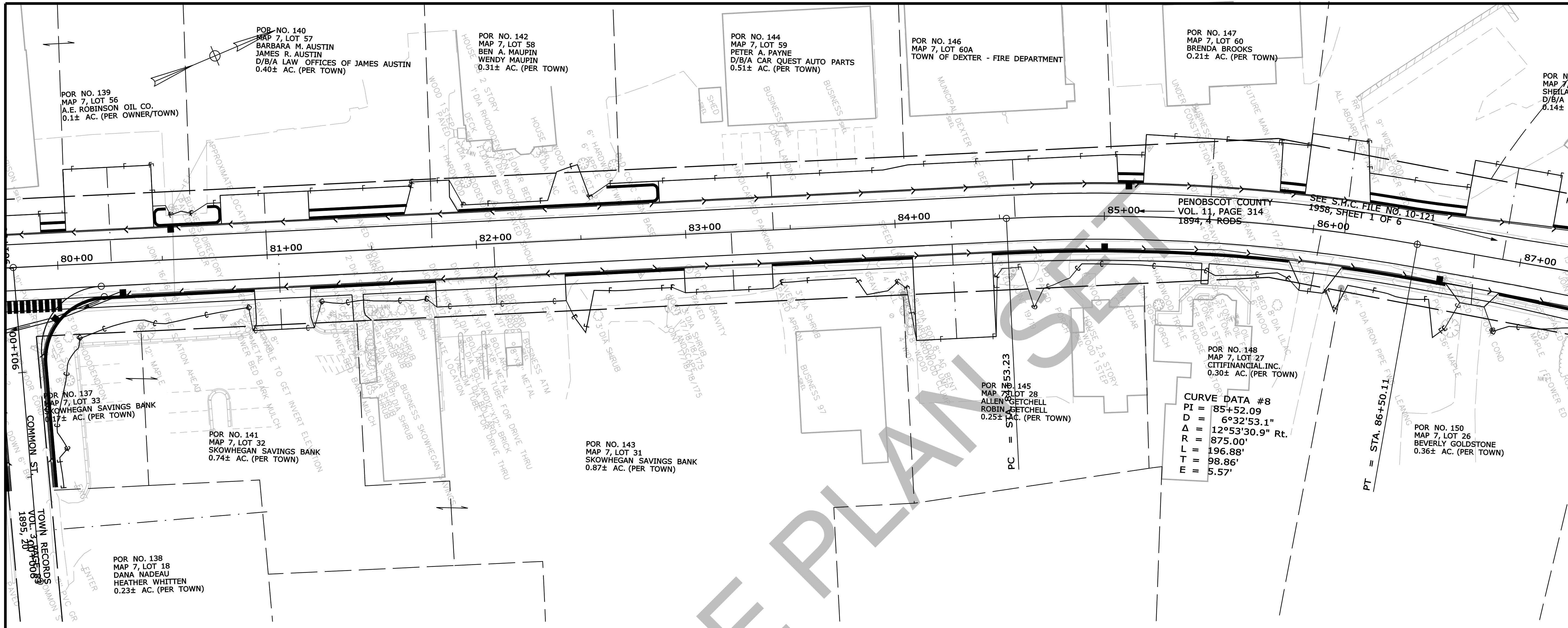

**STATE OF MAINE**  
**DEPARTMENT OF TRANSPORTATION**

**018246-00**  
**WIN**  
**18246.00**

**DATE**  
**BY**  
**SIGNATURE**  
**P.E. NUMBER**  
**DATE**

**PROJ. MANAGER** ERNEST MARTIN  
**DESIGN-DETAILED** TRAVIS WOLFE  
**CHECKED-REVIEWED**  
**DESIGNS-DETAILED**  
**REVISIONS 1**  
**REVISIONS 2**  
**REVISIONS 3**  
**REVISIONS 4**  
**FIELD CHANGES**

**DEXTER**  
**ROUTE 7**  
**PLANS**

**SHEET NUMBER**  
**17**  
**OF 15**

**STA. 80+00.00 TO STA. 87+00.00**



Date: 5/19/2014

Username: Ailee.Mousseau

Division: HIGHWAY

Filename: ... \018\_HDPLAN.DGN

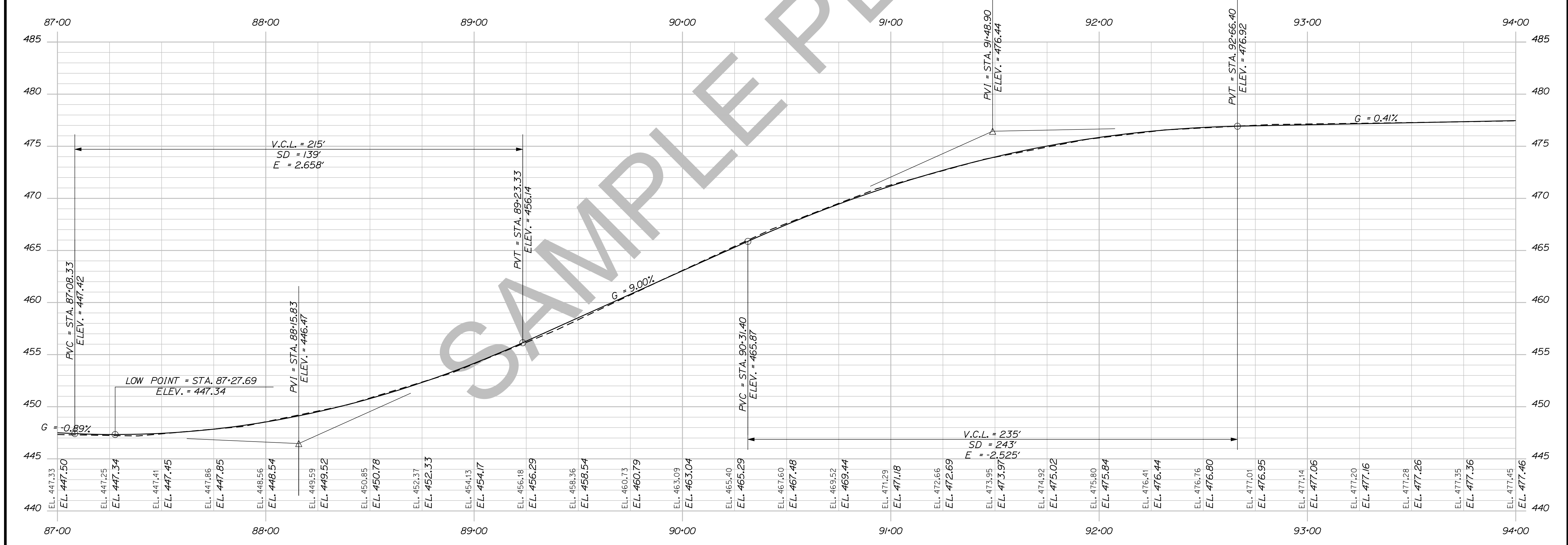
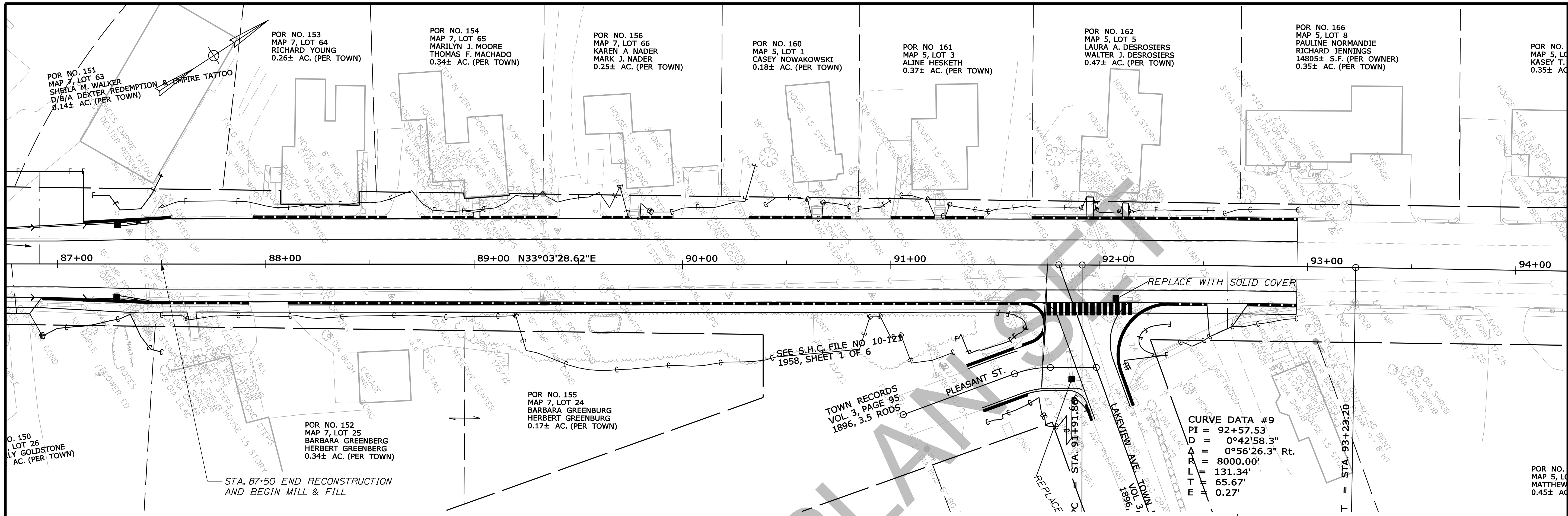

PROFILE

STATE OF MAINE  
DEPARTMENT OF TRANSPORTATION  
018246.00  
WIN  
18246.00  
HIGHWAY PLANS

DATE	BY	REVISION
	ERNEST MARTIN	DESIGN-DETAILED
	TRAVIS WHEELER	CHECKED-REVIEWED
		DESIGNS-DETAILED
		DESIGNS-DETAILED
		REVISIONS 1
		REVISIONS 2
		REVISIONS 3
		REVISIONS 4
		FIELD CHANGES

DEXTER  
ROUTE 7  
PLANS

SHEET NUMBER  
18  
OF 15

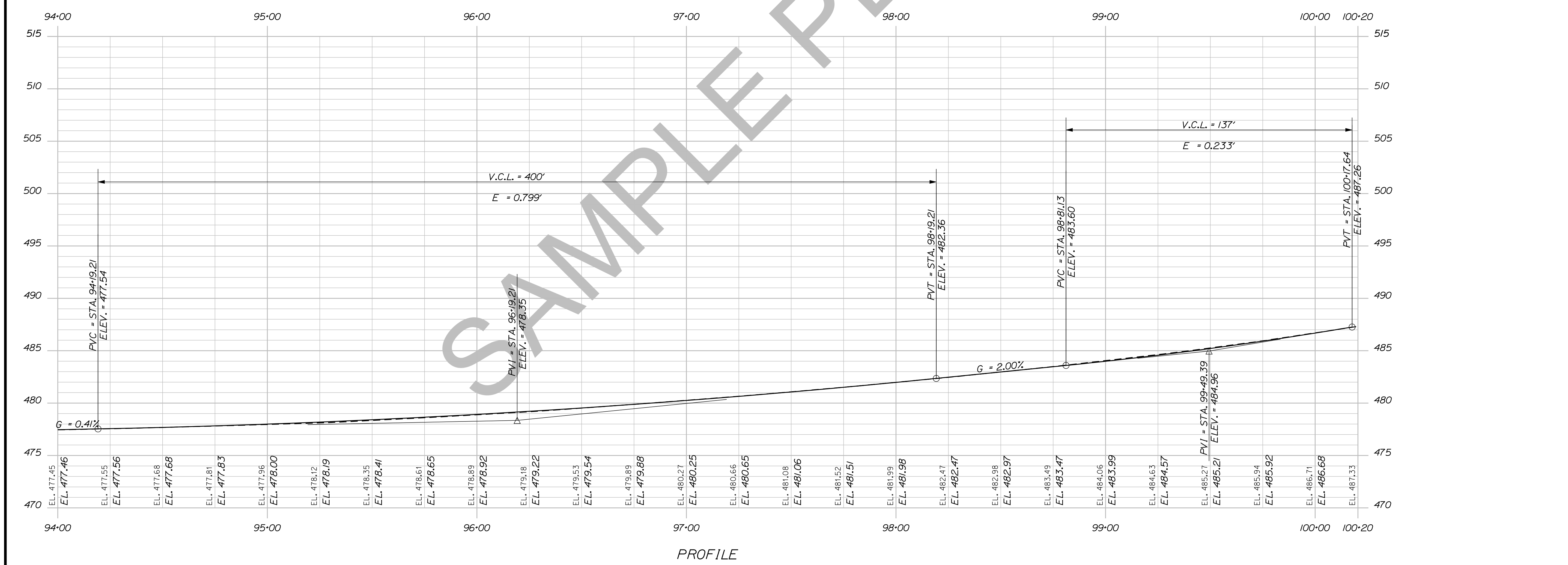
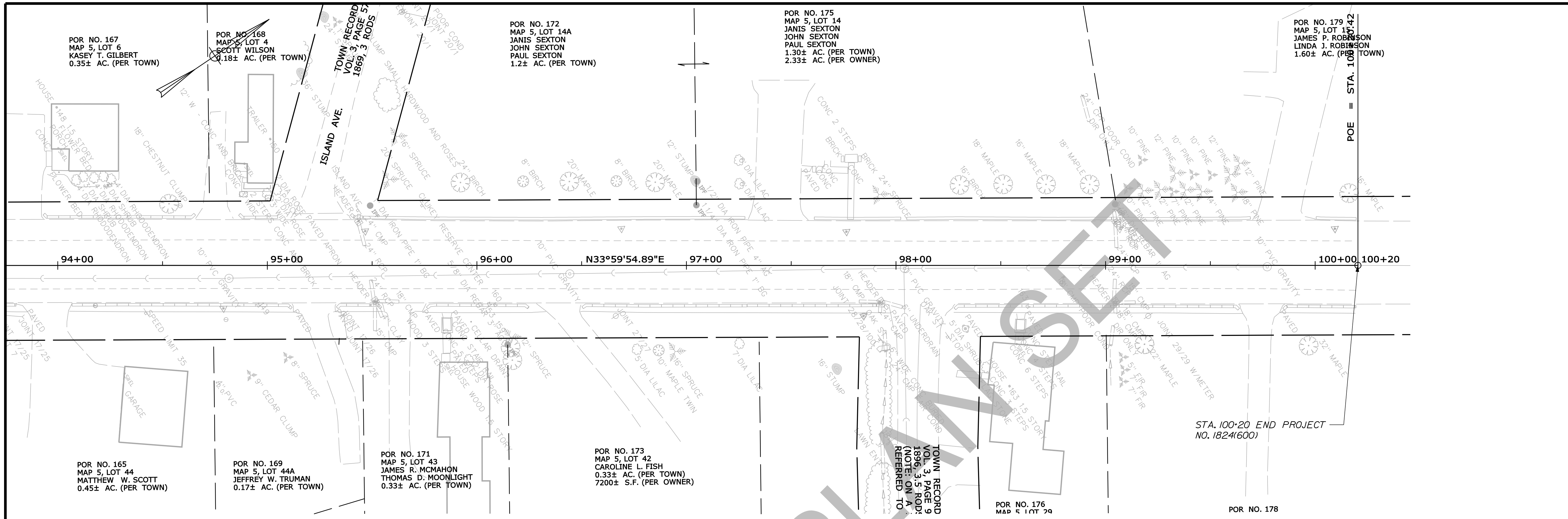

<b>STATE OF MAINE</b>		<b>DEPARTMENT OF TRANSPORTATION</b>	
<b>018246.00</b>		<b>WIN</b>	
<b>18246.00</b>		<b>HIGHWAY PLANS</b>	
<b>DEXTER ROUTE 7</b>	<b>PLANS</b>	<b>DATE</b>	<b>BY</b>
<b>SHEET NUMBER</b>	<b>19</b>	<b>DESIGN-DETAILED</b>	<b>ERNEST MARTIN</b>
<b>OF 15</b>	<b>19</b>	<b>CHECKED-REVIEWED</b>	<b>TRAVIS WOLFE</b>
		<b>DESIGNS-DETAILED</b>	
		<b>DESIGNS-DETAILED</b>	
		<b>REVISIONS 1</b>	
		<b>REVISIONS 2</b>	
		<b>REVISIONS 3</b>	
		<b>REVISIONS 4</b>	
		<b>FIELD CHANGES</b>	

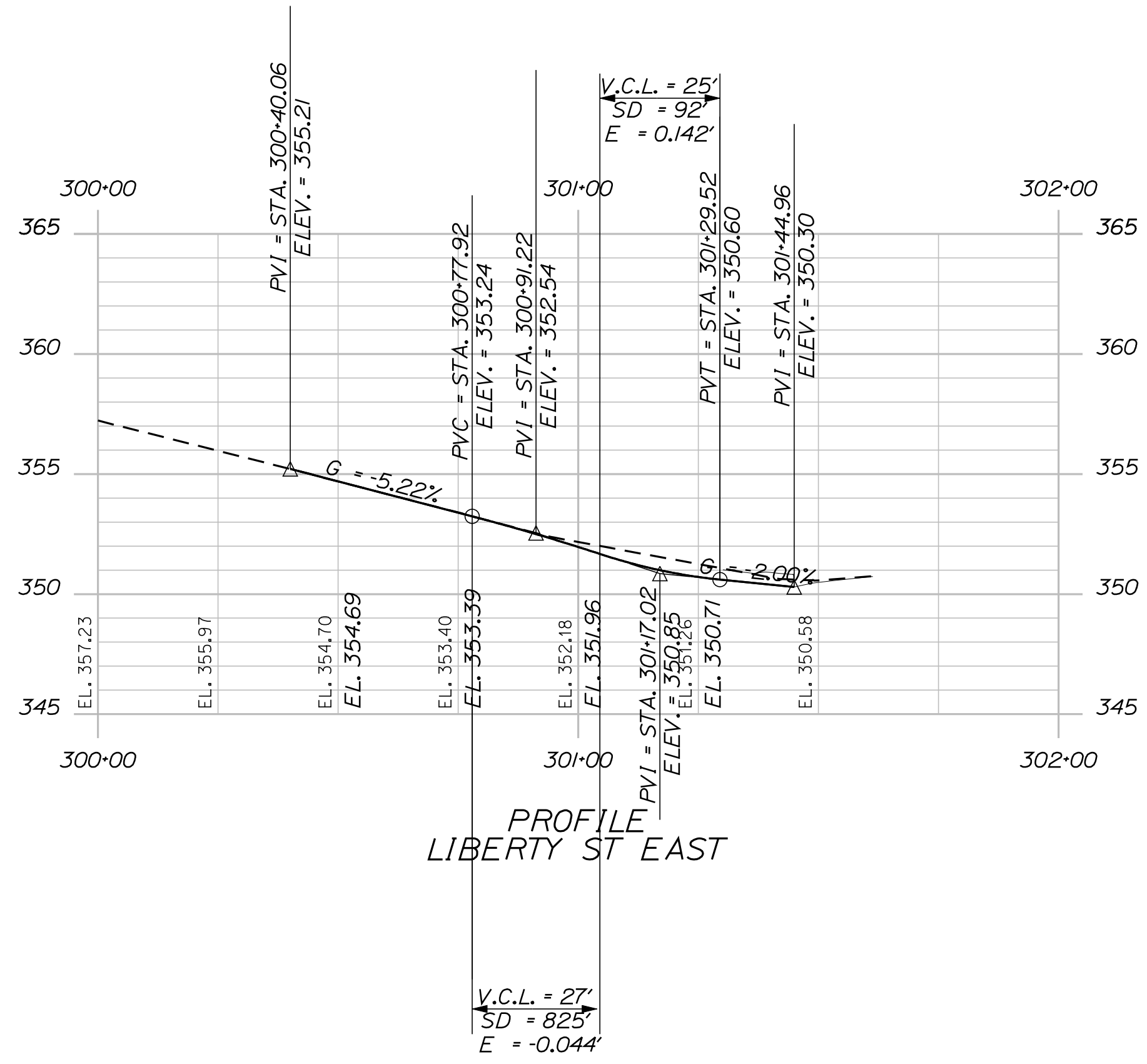
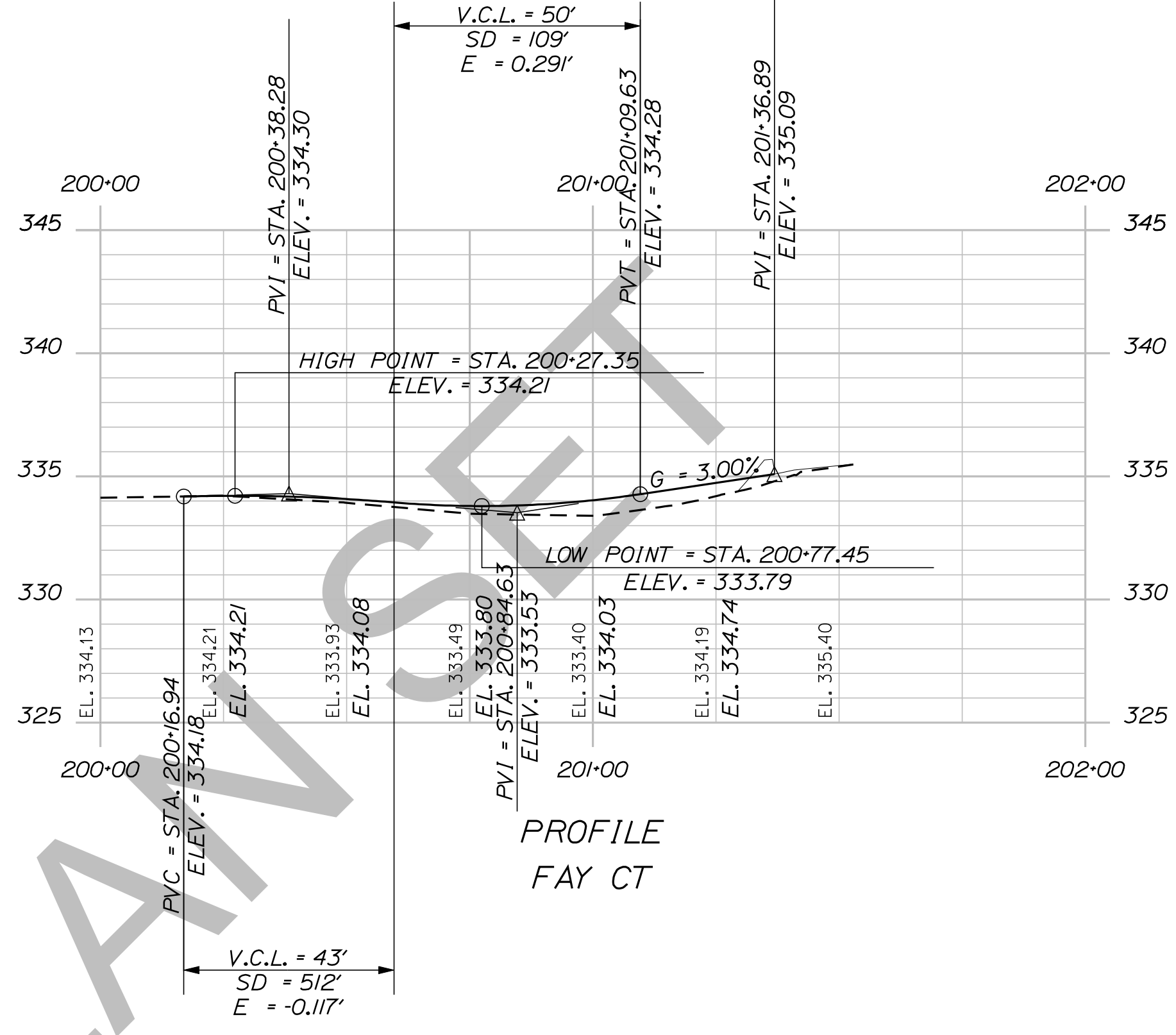
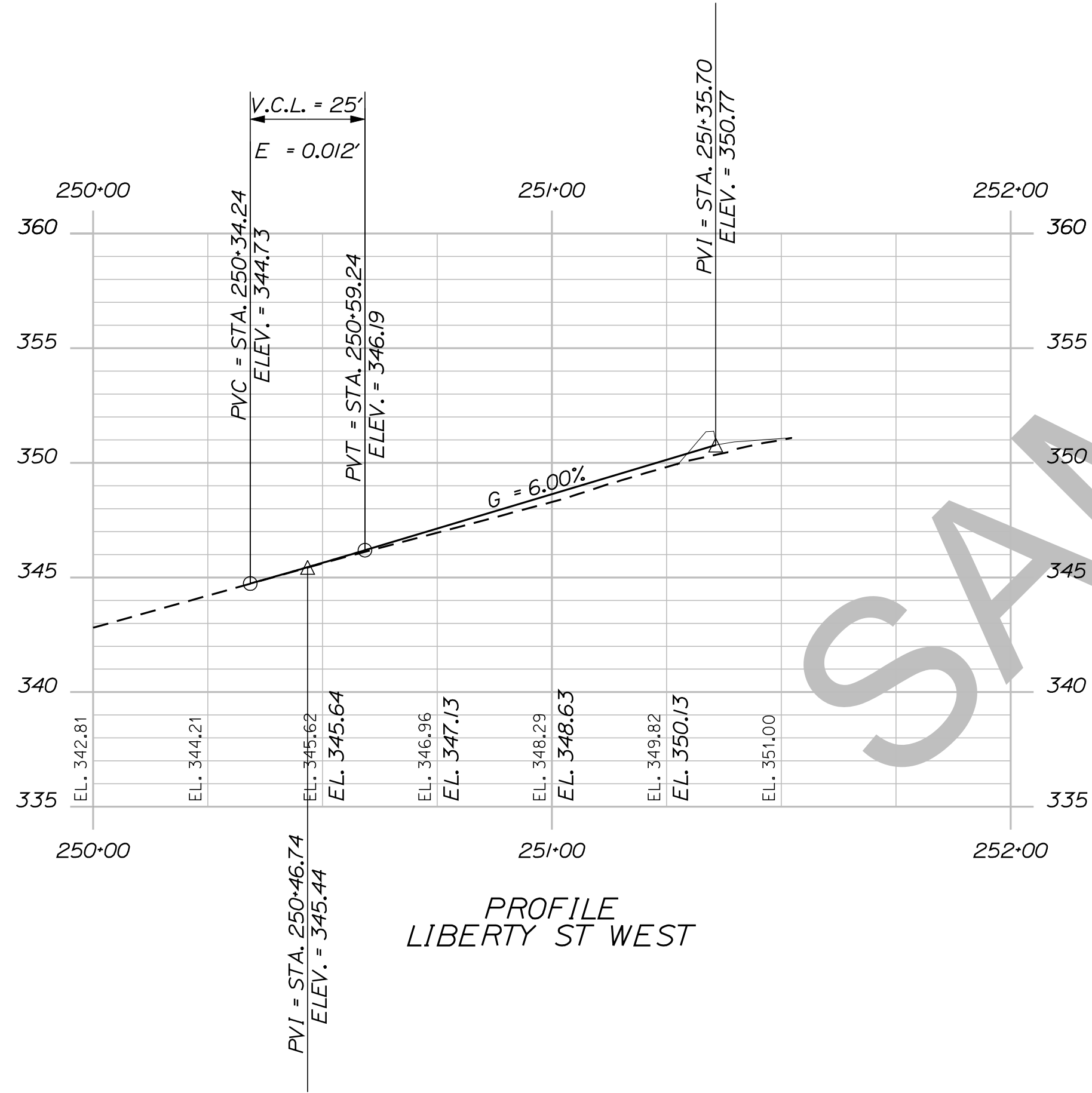
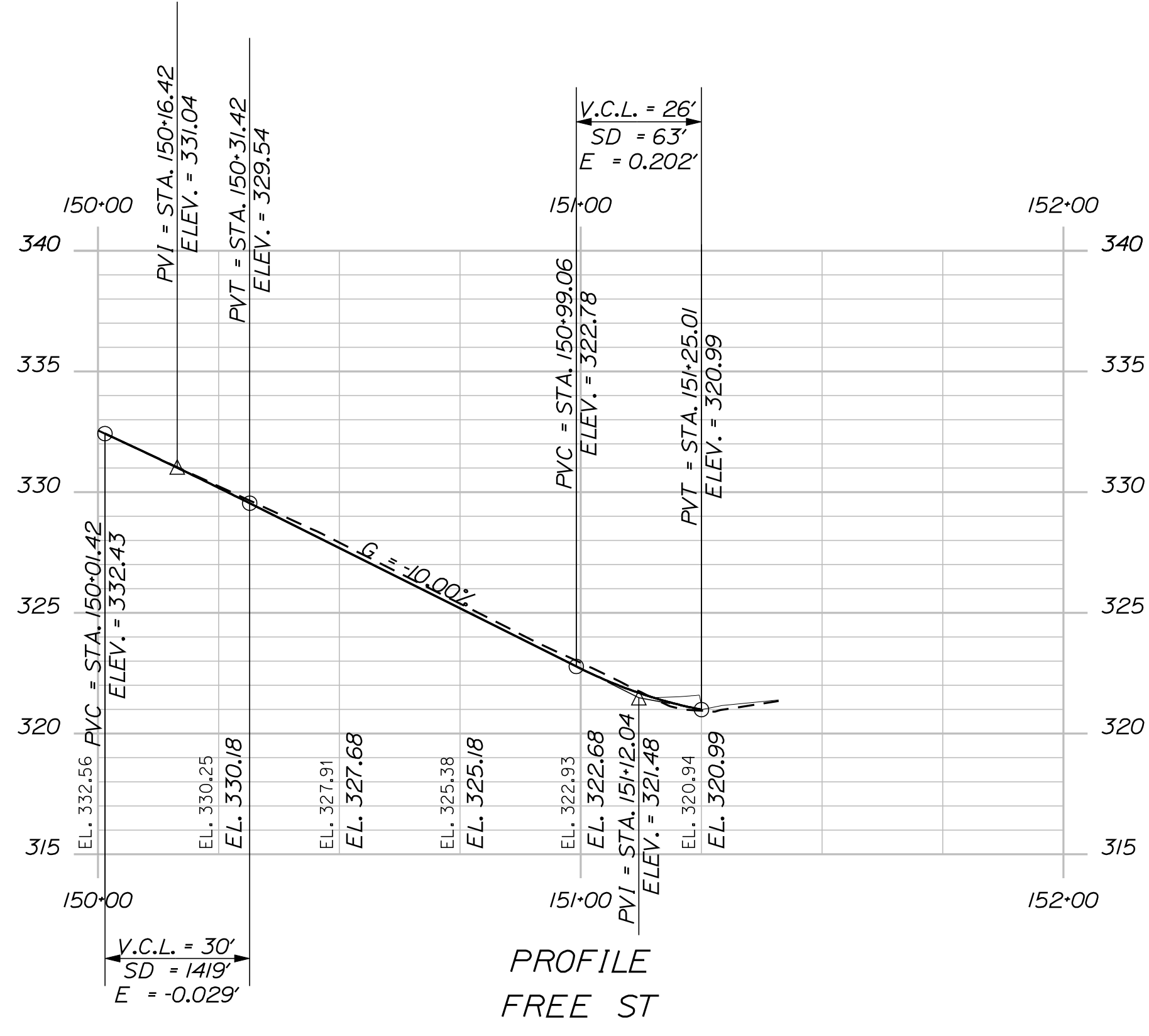

STATE OF MAINE  
DEPARTMENT OF TRANSPORTATION

018246-00  
WIN  
18246.00  
HIGHWAY PLANS

DESIGN DETAILED	CHECKED-REVIEWED	DESIGN DETAILED	DESIGN DETAILED	REVISIONS 1	REVISIONS 2	REVISIONS 3	REVISIONS 4	FIELD CHANGES
TRAVIS WOLFE								

DEXTER  
ROUTE 7  
PROFILE

SHEET NUMBER  
**29**  
OF 15



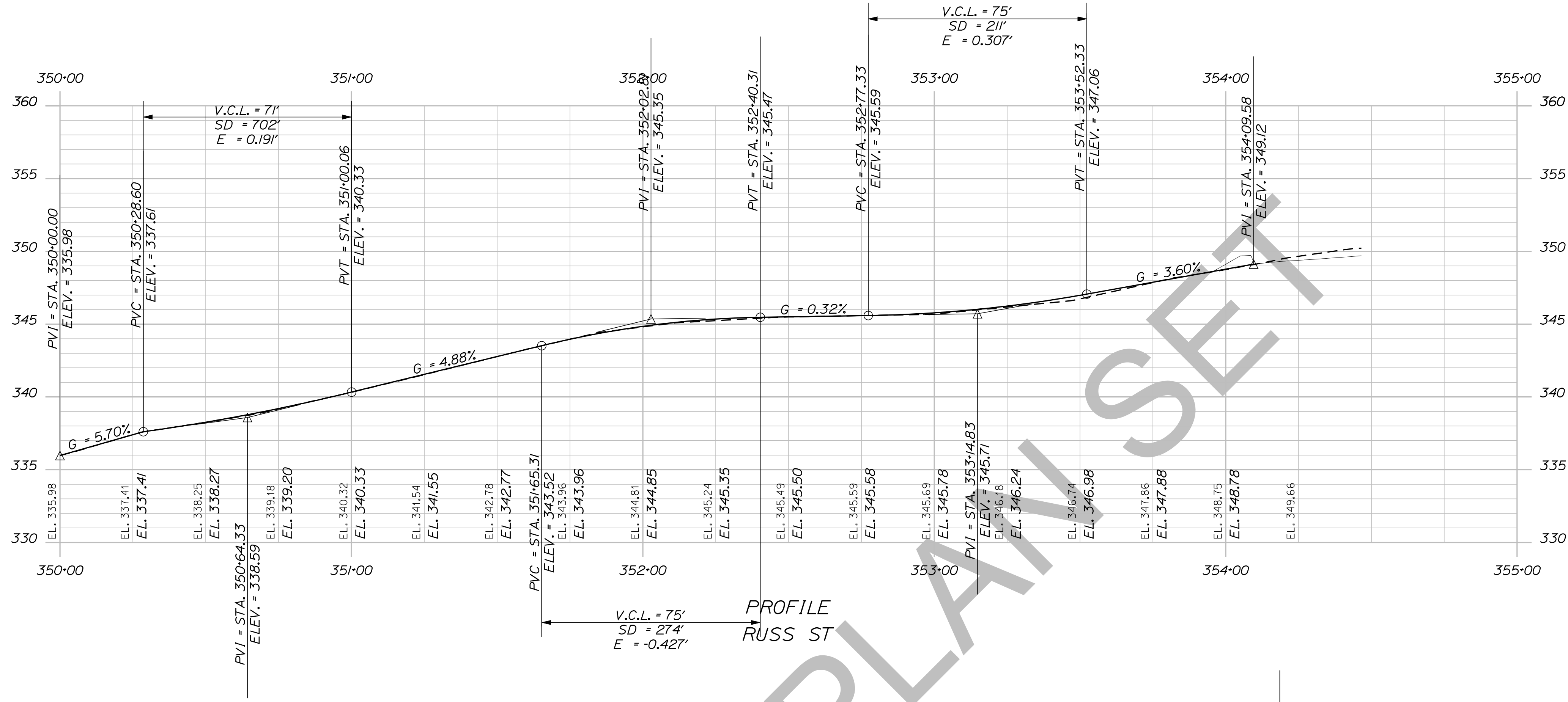
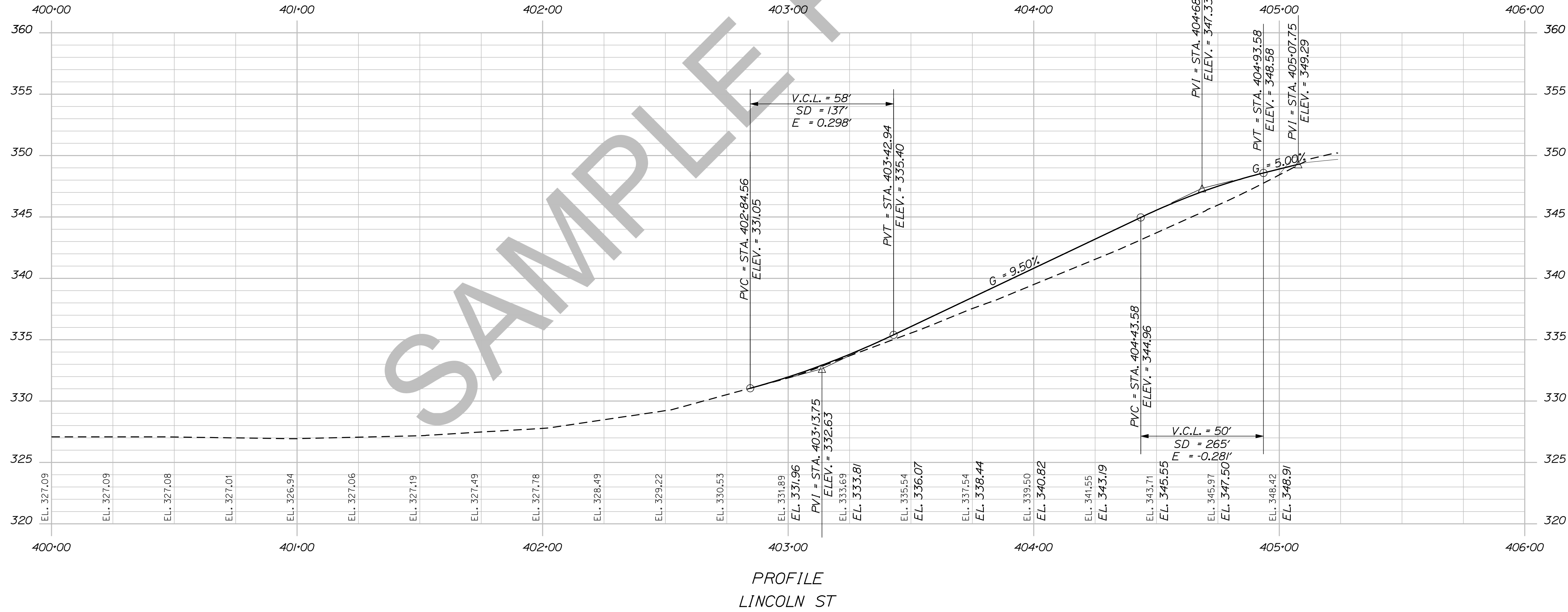

SHEET NUMBER

30

OF 15

DEXTER  
ROUTE 7  
PROFILE

DESIGN-DETAILED	CHECKED-REVIEWED	DESIGNS-DETAILED	REVISIONS 1	REVISIONS 2	REVISIONS 3	REVISIONS 4	FIELD CHANGES
TRAVIS WOLFE							

PROJ. MANAGER	BY	DATE
ERNEST MARTIN	TRAVIS WOLFE	

STATE OF MAINE  
DEPARTMENT OF TRANSPORTATION  
018246-00  
WIN  
18246.00  
HIGHWAY PLANS

SIGNATURE  
P.E. NUMBER  
DATE

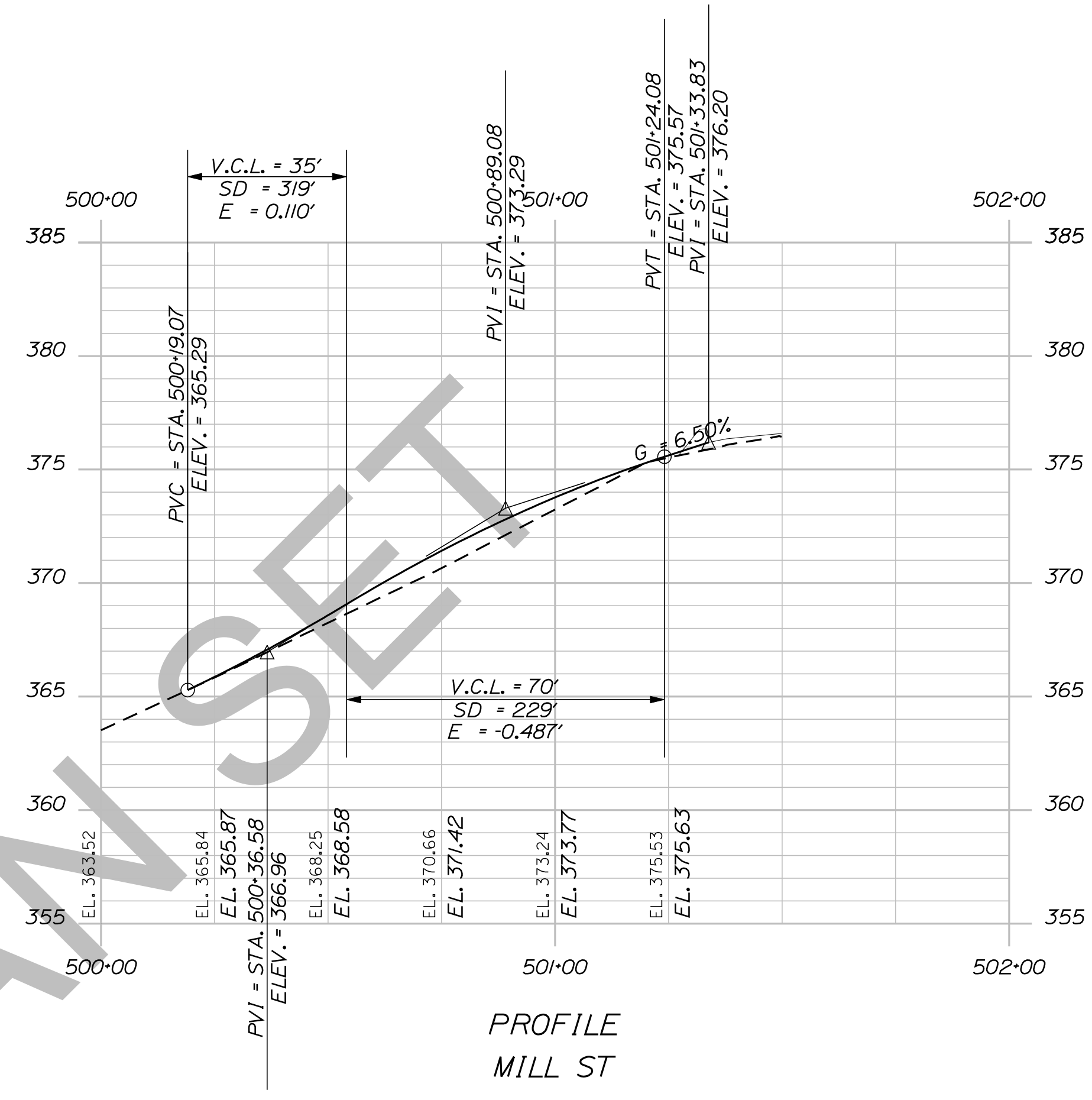
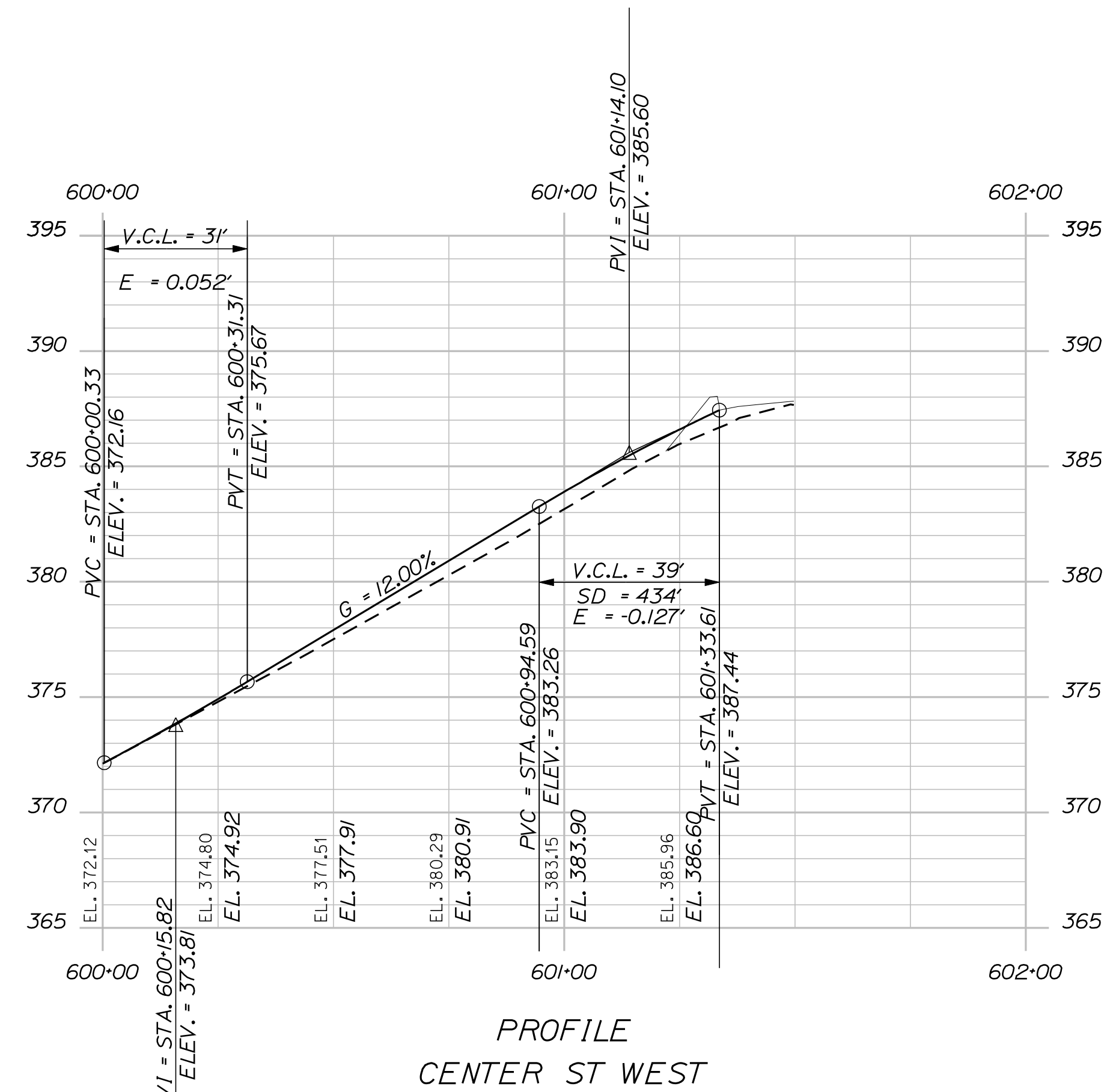
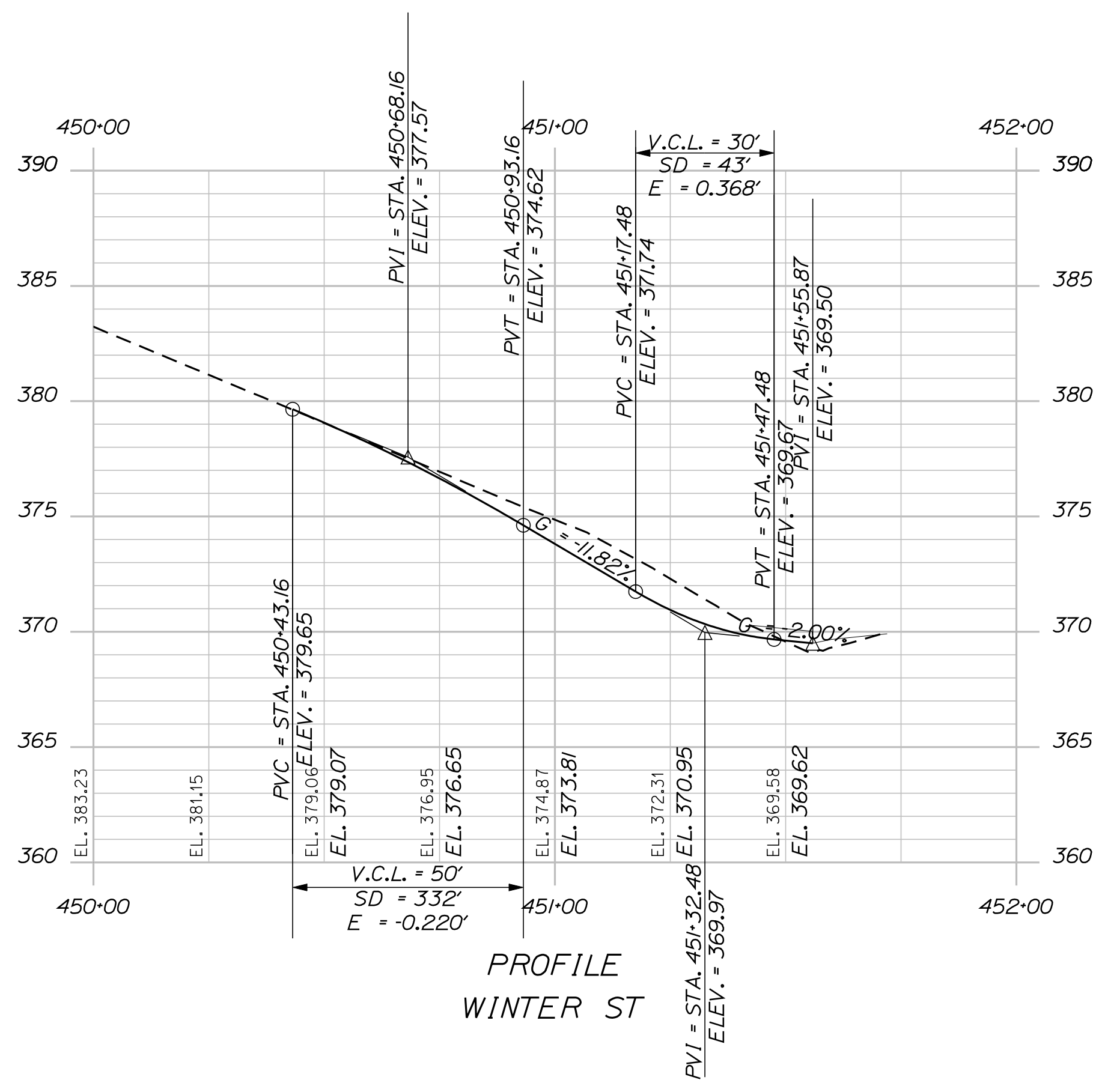
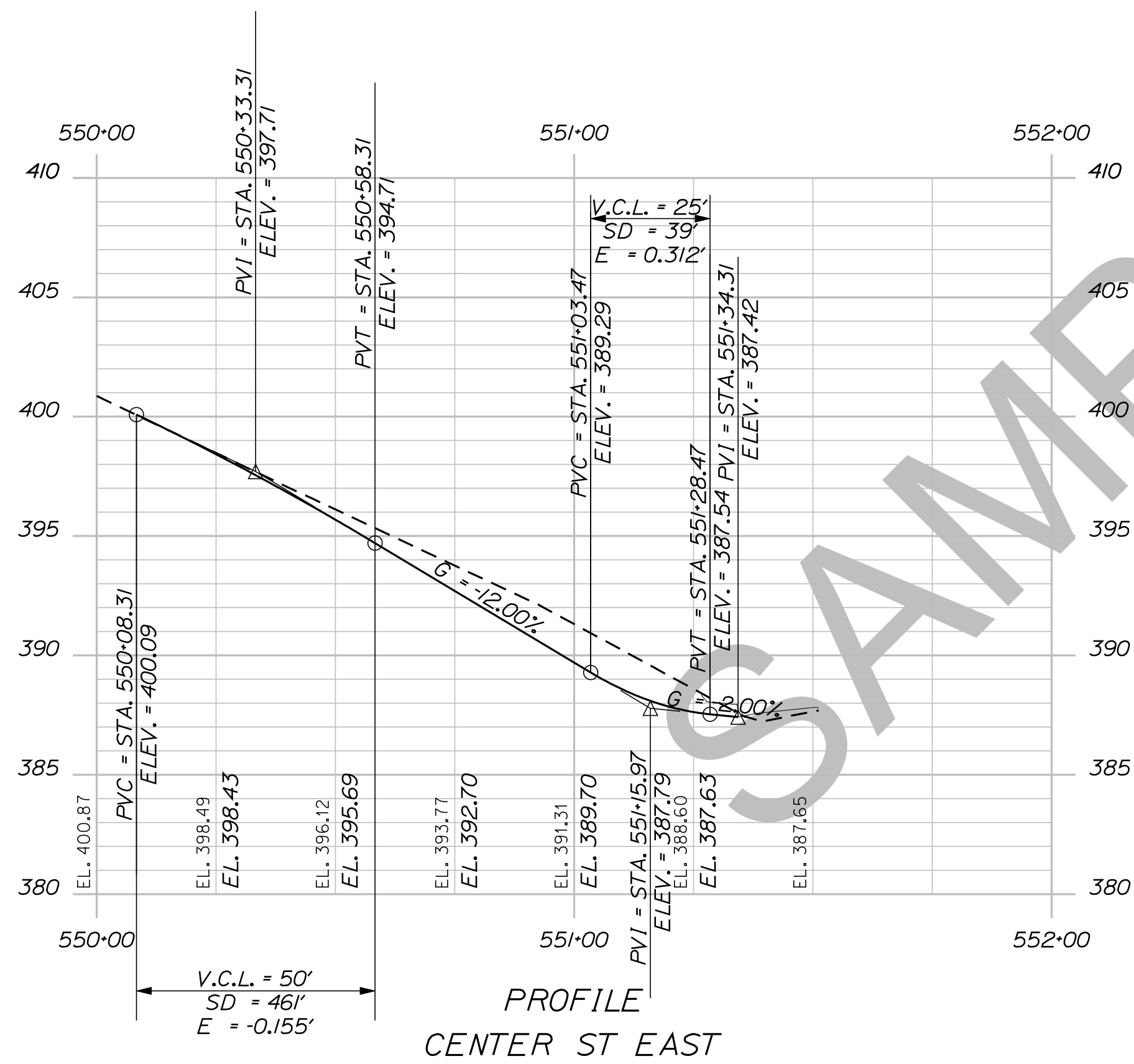

SHEET NUMBER  
**31**  
OF 15

DEXTER  
ROUTE 7  
PROFILE

PROJ. MANAGER	ERNEST MARTIN	BY	DATE
DESIGN-DETAILED	TRAVIS WOLFE		
CHECKED-REVIEWED			
DESIGNS DET AILED			
DESIGNS DET AILED			
REVISIONS 1			
REVISIONS 2			
REVISIONS 3			
REVISIONS 4			
FIELD CHANGES			

STATE OF MAINE  
DEPARTMENT OF TRANSPORTATION  
018246-00  
WIN  
18246.00  
HIGHWAY PLANS

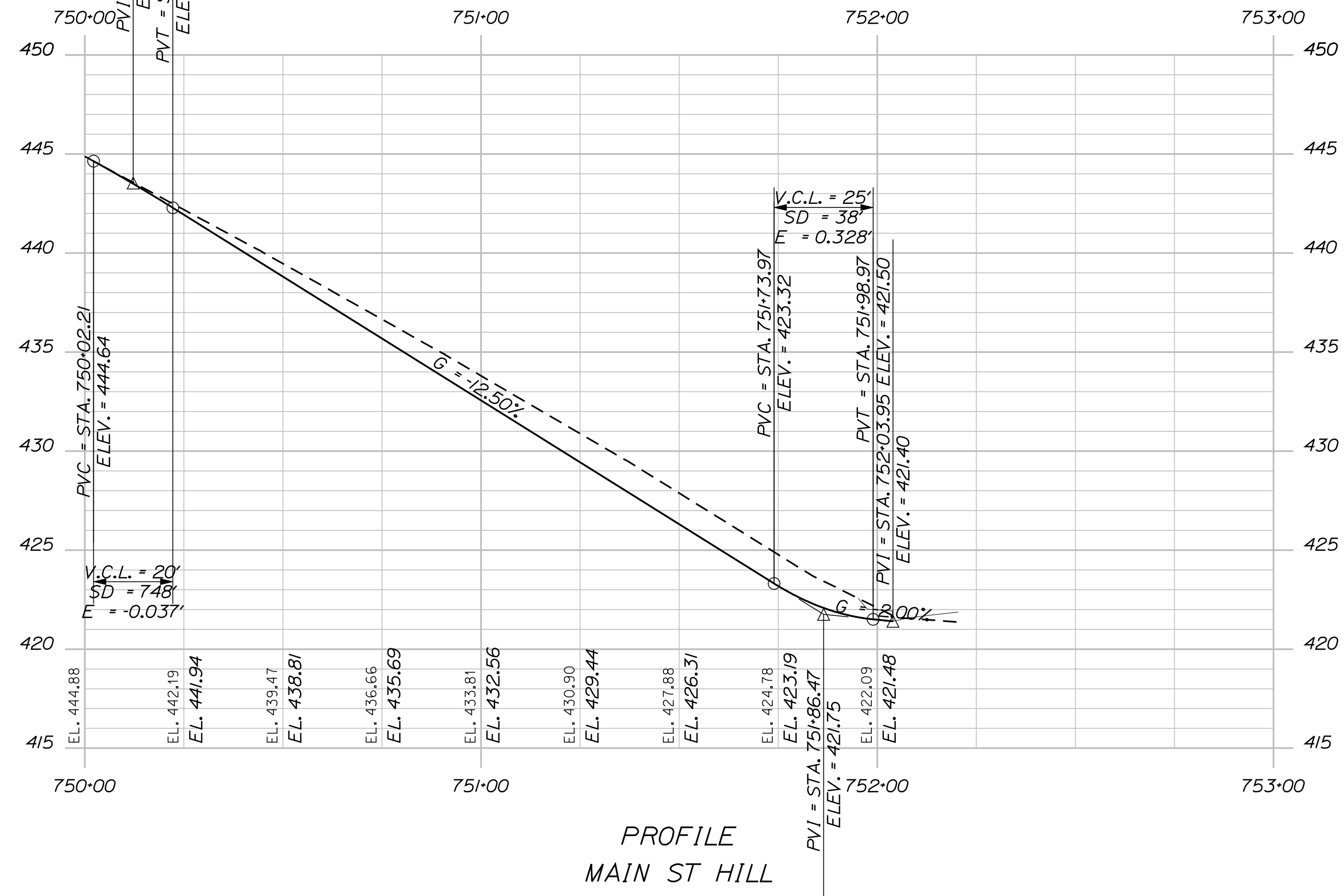
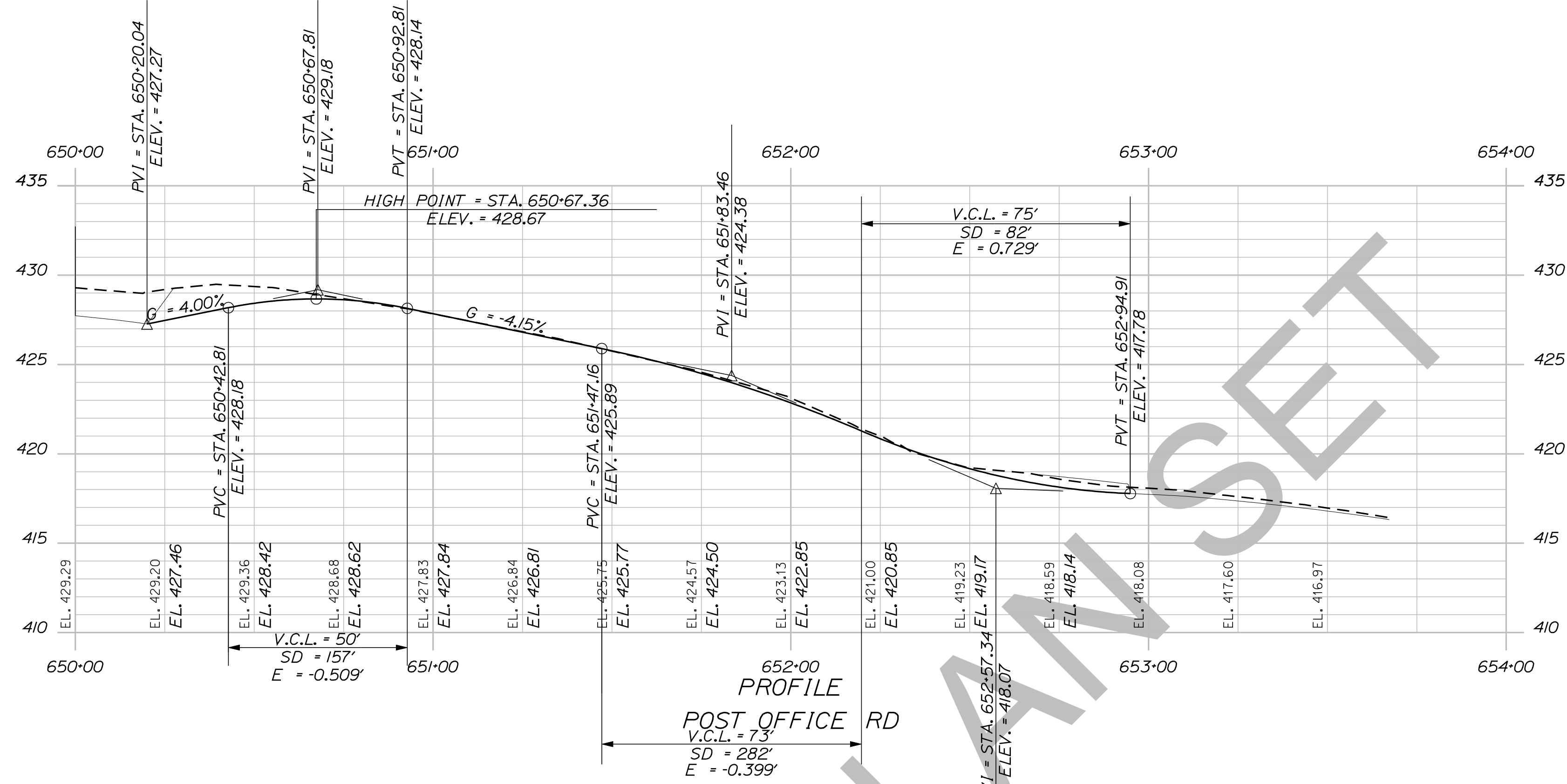
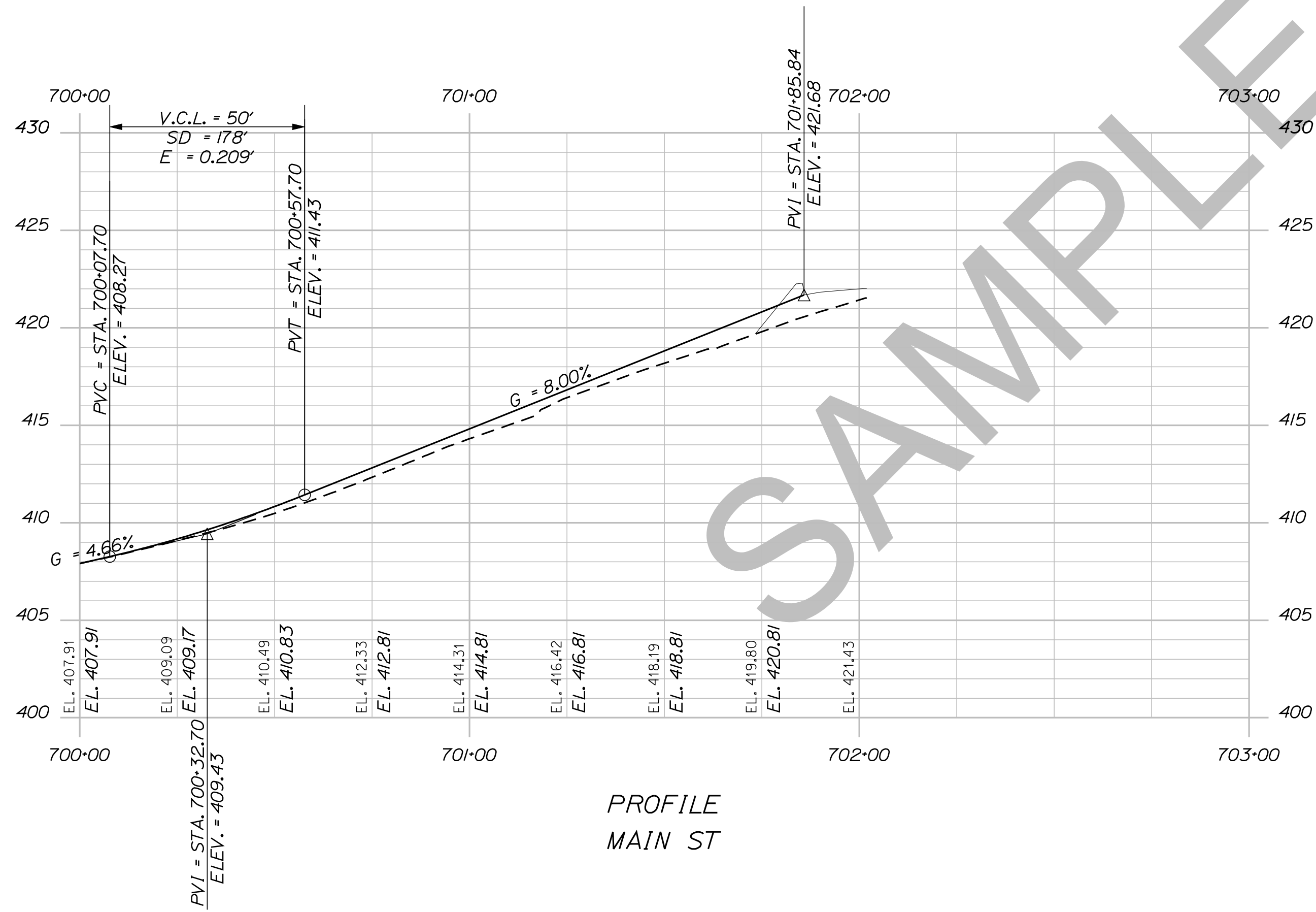

STATE OF MAINE  
DEPARTMENT OF TRANSPORTATION

018246.00  
WIN  
18246.00  
HIGHWAY PLANS

PROJ. MANAGER	BY	DATE
ERNEST MARTIN	TRAVIS WOLFE	
CHECKED-REVIEWED		
DESIGNED-DETAILED		
DESIGNED-DETAILED		
REVISIONS 1		
REVISIONS 2		
REVISIONS 3		
REVISIONS 4		
FIELD CHANGES		

DEXTER  
ROUTE 7  
PROFILE

SHEET NUMBER  
**32**  
OF 15



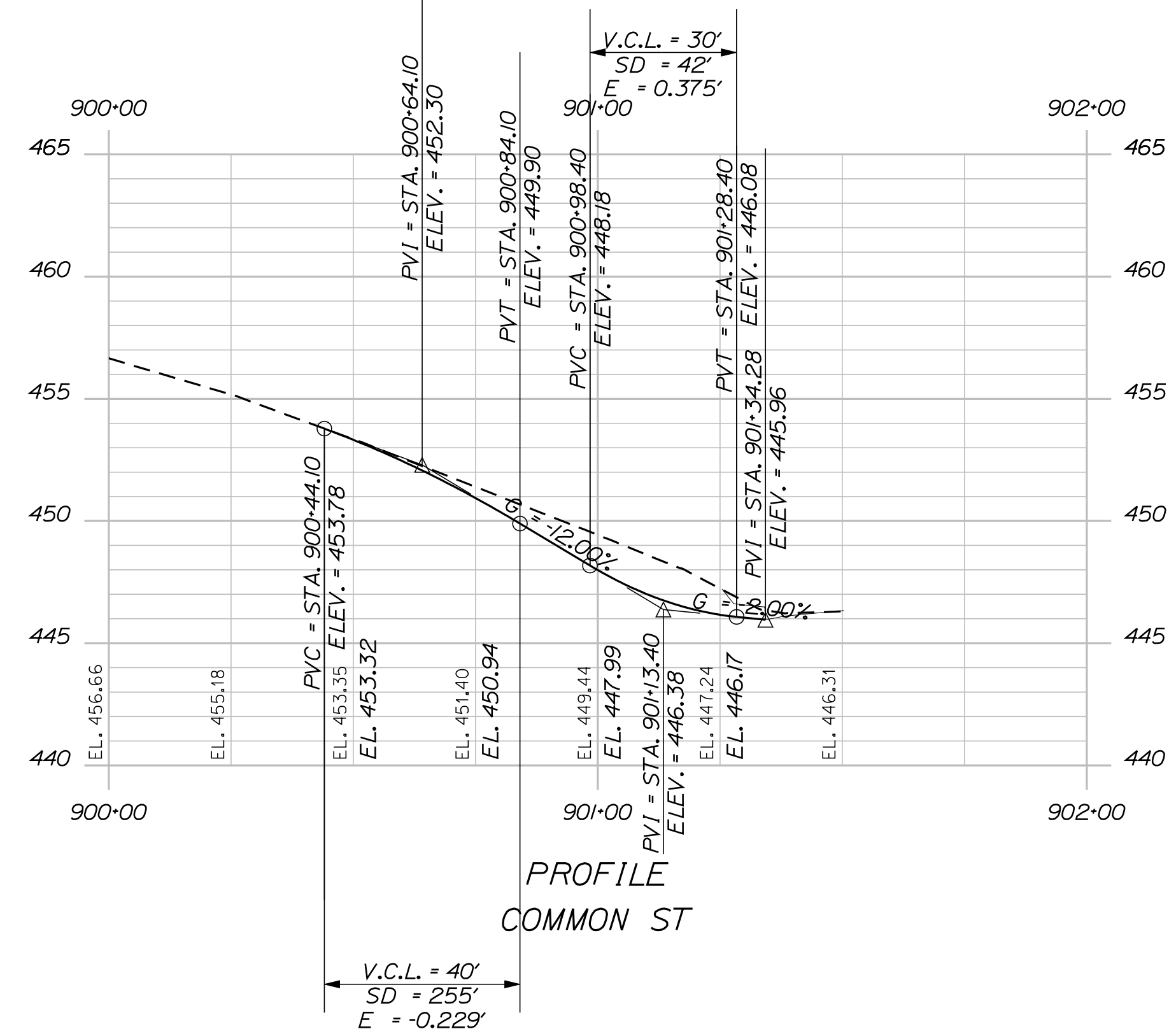
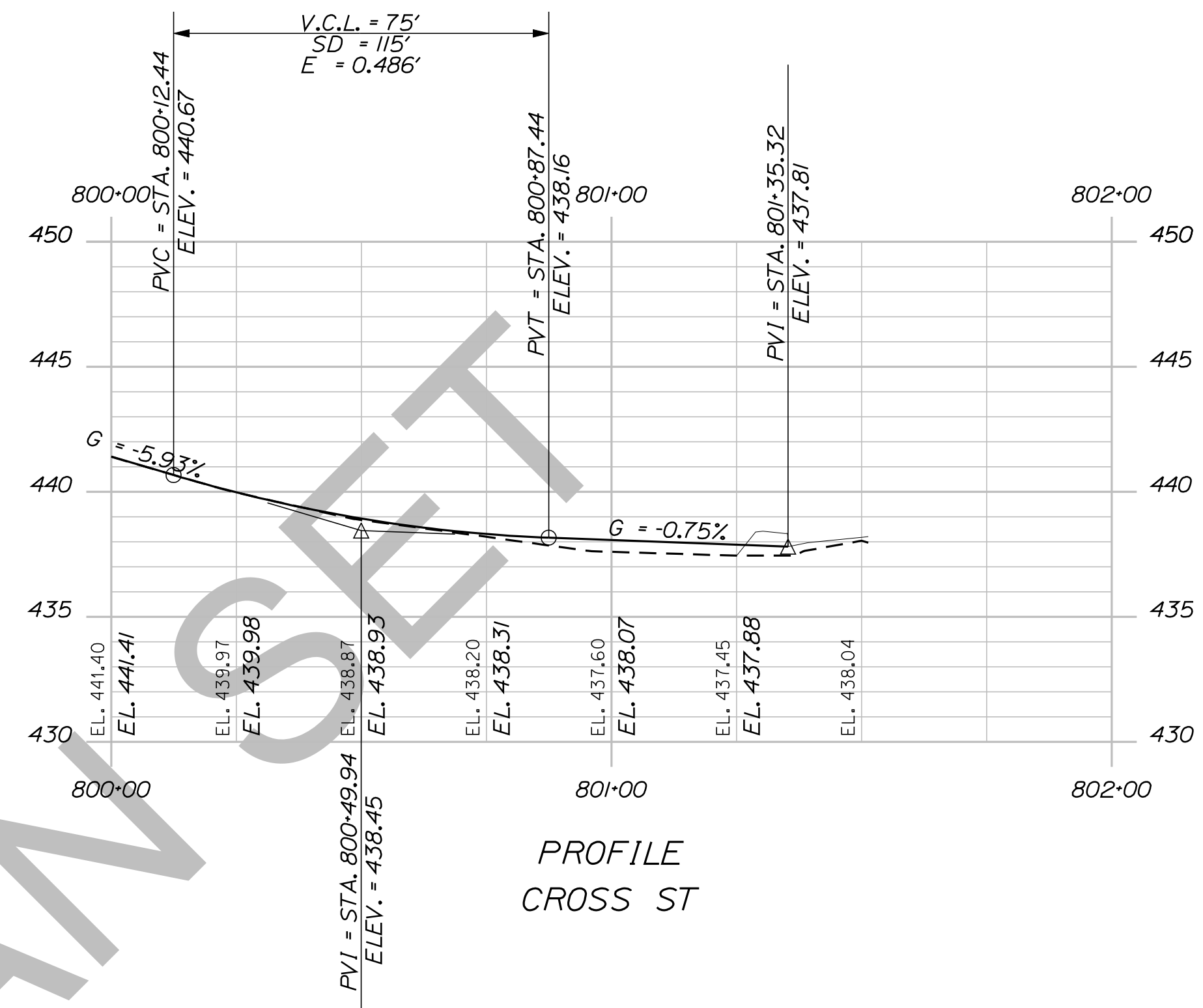
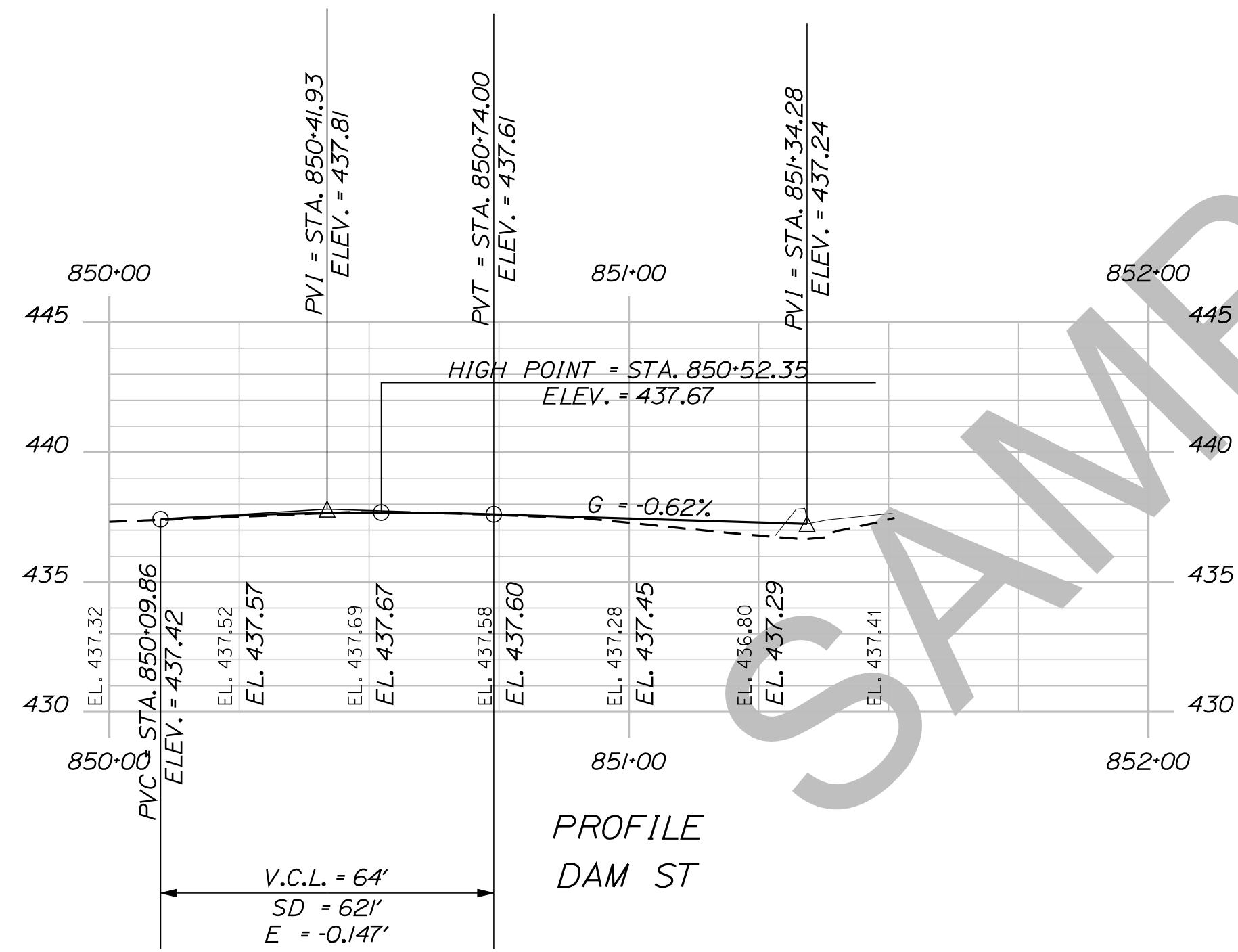
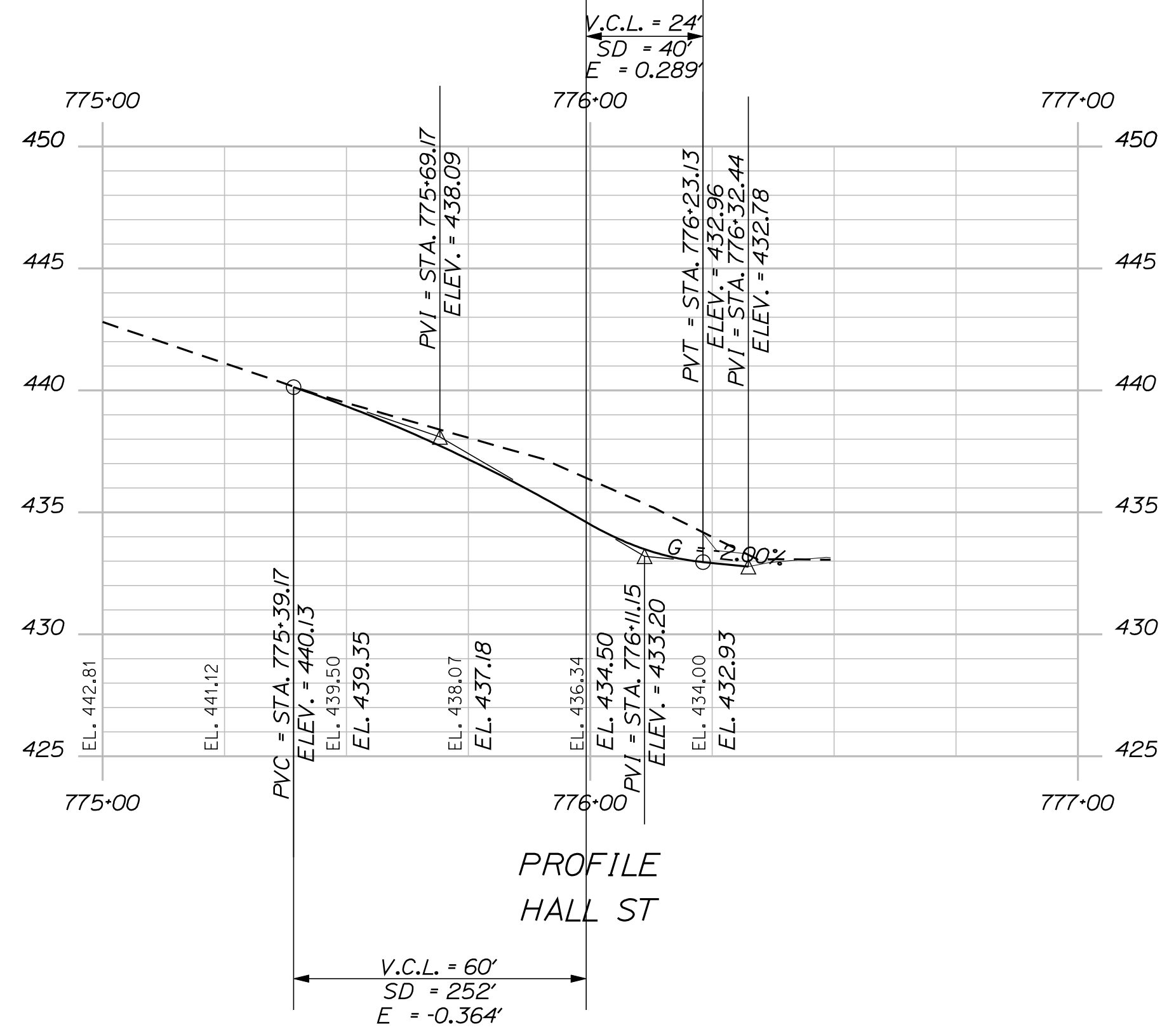

STATE OF MAINE  
DEPARTMENT OF TRANSPORTATION

DESIGN-REVIEWED	BY	DATE
TRAVIS WOLFE		
DESIGN-DETAILED		
DESIGN-DETAILED 2		
DESIGN-DETAILED 3		
REVISIONS 1		
REVISIONS 2		
REVISIONS 3		
REVISIONS 4		
FIELD CHANGES		

DEXTER  
ROUTE 7  
PROFILE

SHEET NUMBER  
**33**  
OF 15

018246.00

WIN  
18246.00

HIGHWAY PLANS

Date: 5/19/2014

Username: Alee.Mousseau

Division: HIGHWAY

Filename: ... \034\_XSECT\_11+00\_001.dgn

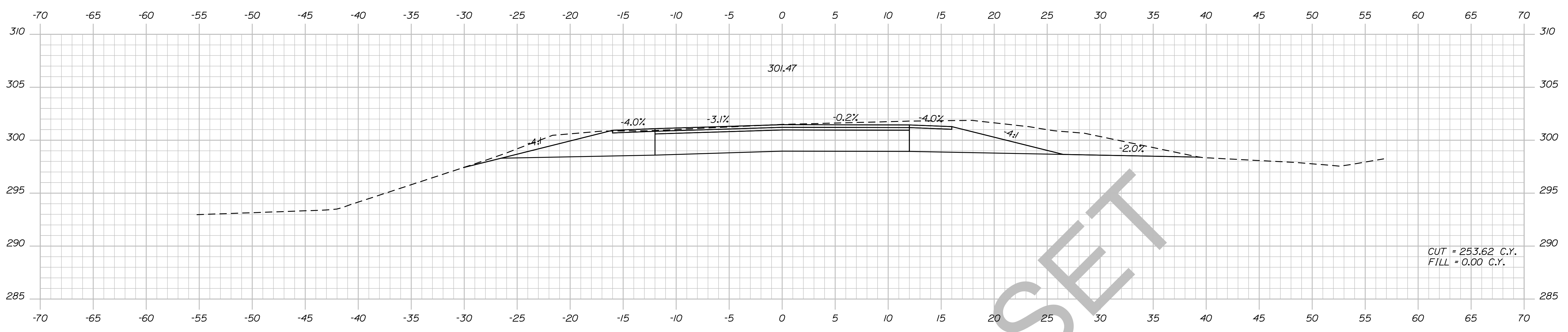

12\*00.00

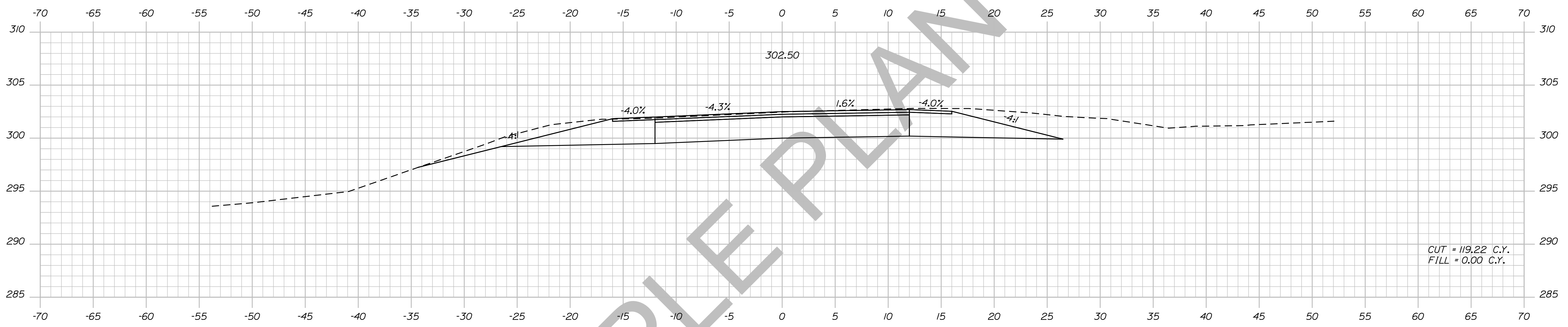

11\*50.00

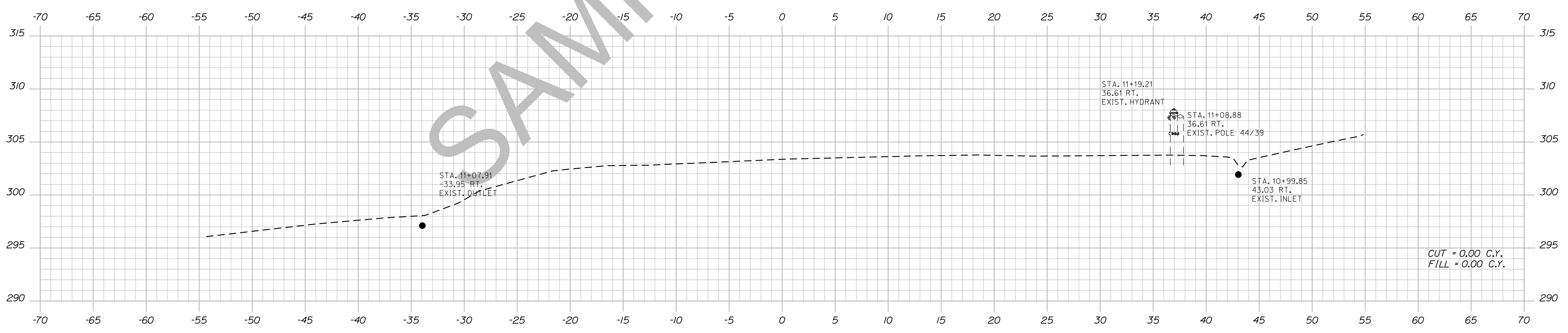

11\*00.00

STATE OF MAINE  
DEPARTMENT OF TRANSPORTATION  
018246.00  
PIN  
18246.00  
HIGHWAY PLANS

DESIGN-DETAILED	CHECKED-REVIEWED	DESIGN-DETAILED	DESIGN-DETAILED	REVISIONS 1	REVISIONS 2	REVISIONS 3	REVISIONS 4	FIELD CHANGES
TRAVIS WOLFE								
DATE								
BY								
PROJ. MANAGER	ERNEST MARTIN							
SIGNATURE		P.E. NUMBER		DATE				

DEXTER  
ROUTE 7  
CROSS SECTIONS

SHEET NUMBER  
**34**  
OF 15

Date: 5/19/2014

Username: Alee.Mousseau

Division: HIGHWAY

Filename: ... \035\_XSECT\_12+50\_002.dgn

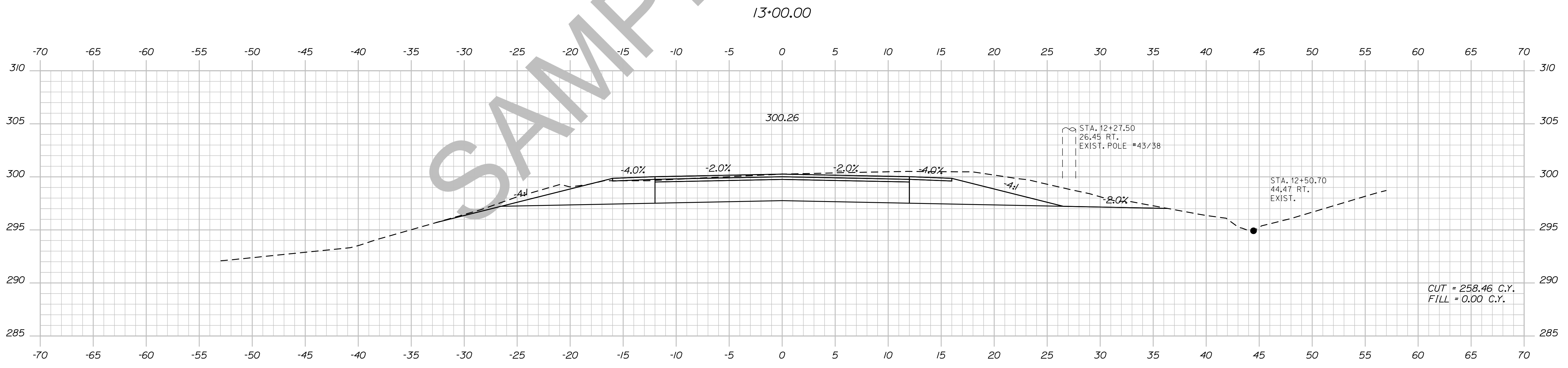
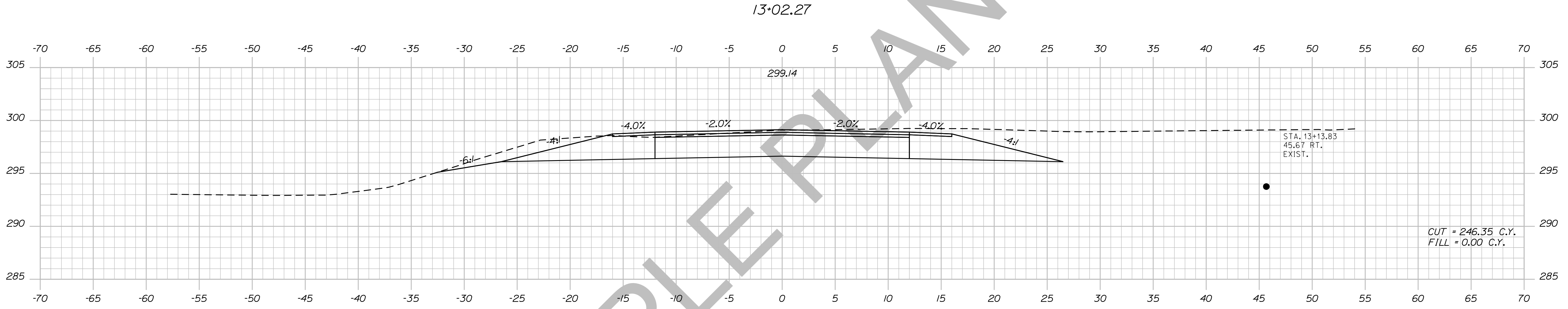
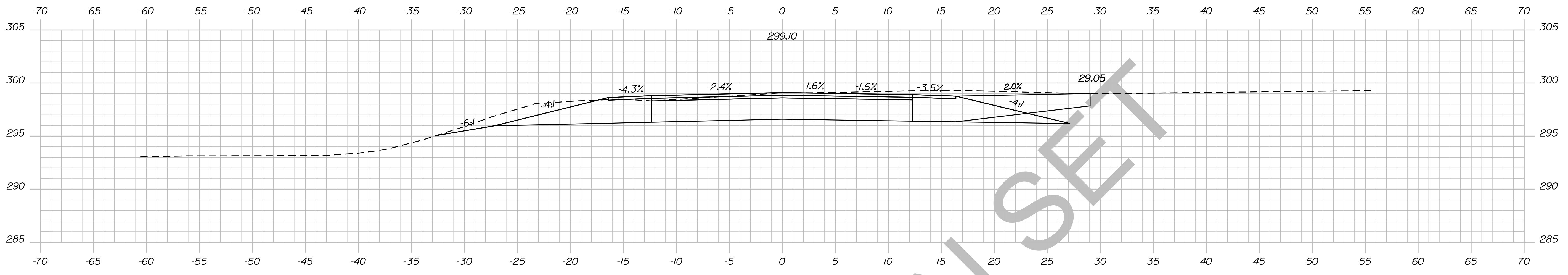

STATE OF MAINE  
DEPARTMENT OF TRANSPORTATION  
018246.00  
PIN 18246.00  
HIGHWAY PLANS

DESIGN-REVIEWED	CHECKED-REVIEWED	PROJ. MANAGER	BY	DATE
		ERNEST MARTIN	TRAVIS WHEEL	
DESIGNS DET AILED	DESIGNS DET AILED			
REVISIONS 1	REVISIONS 1			
REVISIONS 2	REVISIONS 2			
REVISIONS 3	REVISIONS 3			
REVISIONS 4	REVISIONS 4			
FIELD CHANGES	FIELD CHANGES			

DEXTER  
ROUTE 7  
CROSS SECTIONS

SHEET NUMBER  
**35**  
OF 15



Date: 5/19/2014

Username: Alee, Mousseau

Division: HIGHWAY

Filename: ... \036\_XSECT\_13+50\_003.dgn

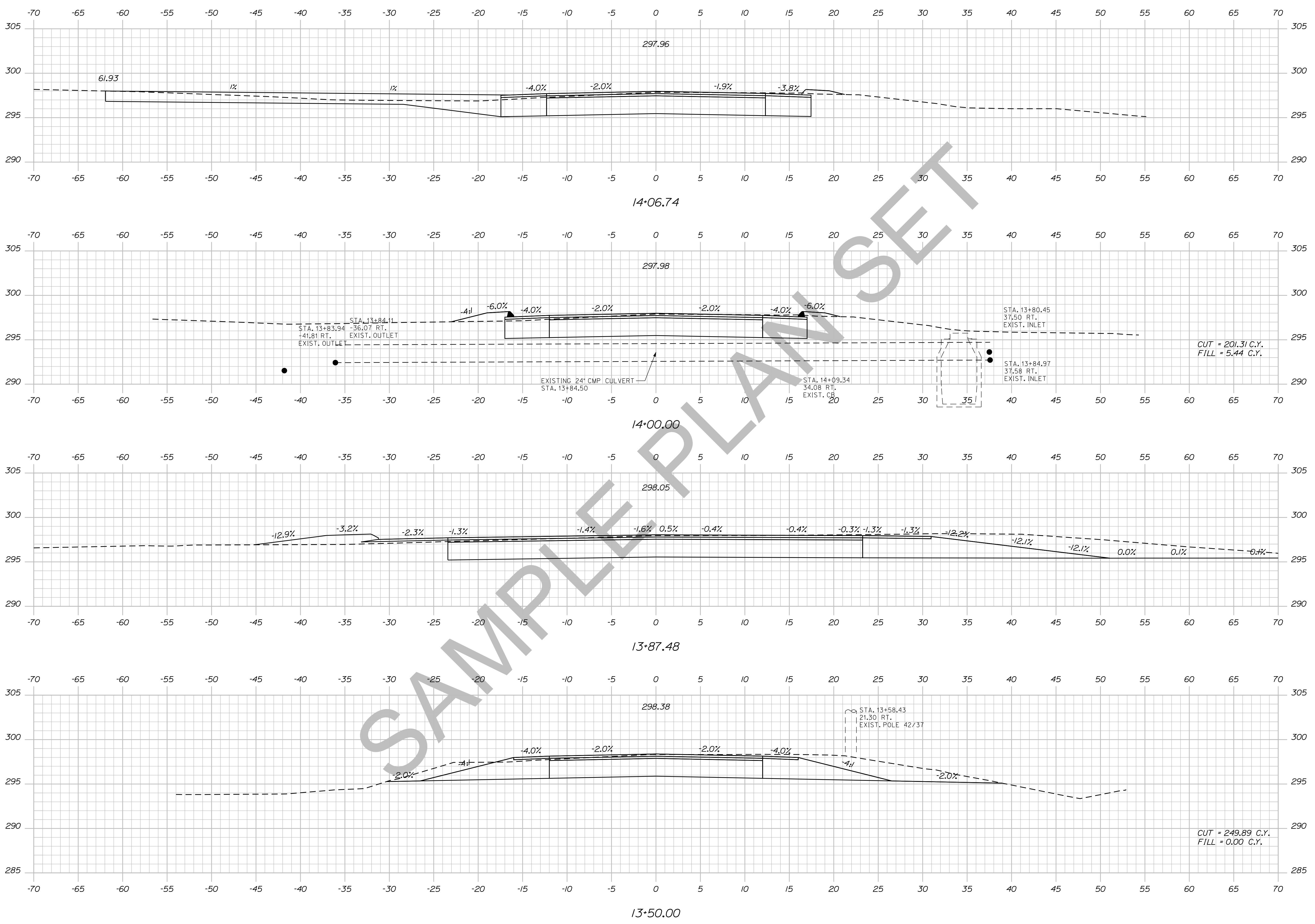

STATE OF MAINE  
DEPARTMENT OF TRANSPORTATION  
018246.00  
PIN 18246.00  
HIGHWAY PLANS

DATE: \_\_\_\_\_  
SIGNATURE: \_\_\_\_\_  
P.E. NUMBER: \_\_\_\_\_  
DATE: \_\_\_\_\_

PROJ. MANAGER: ERNEST MARTIN  
BY: TRAVIS WOLFE  
DESIGN/REVIEWED: \_\_\_\_\_  
DESIGN/REVIEWED: \_\_\_\_\_  
DESIGN/REVIEWED: \_\_\_\_\_  
DESIGN/REVIEWED: \_\_\_\_\_  
REVISIONS 1: \_\_\_\_\_  
REVISIONS 2: \_\_\_\_\_  
REVISIONS 3: \_\_\_\_\_  
REVISIONS 4: \_\_\_\_\_  
FIELD CHANGES: \_\_\_\_\_

DEXTER  
ROUTE 7  
CROSS SECTIONS

SHEET NUMBER  
36  
OF 15

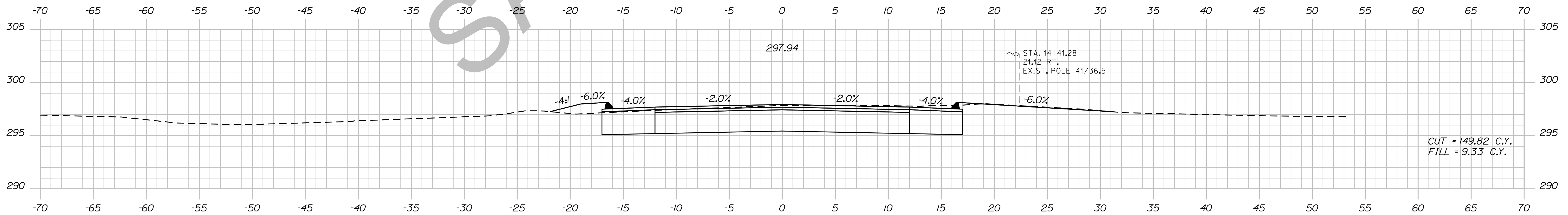
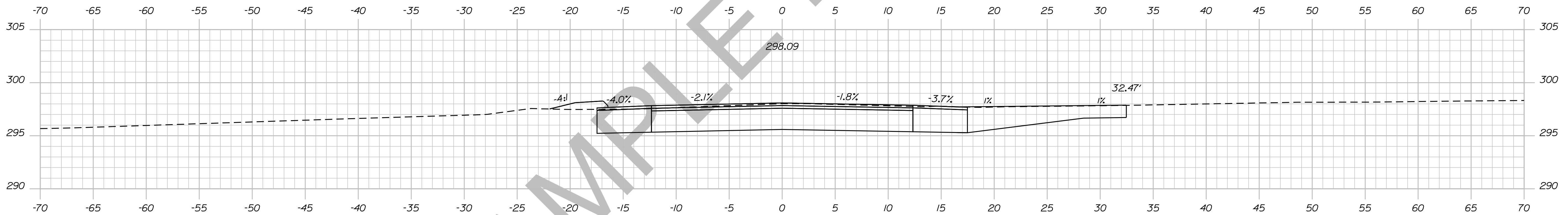
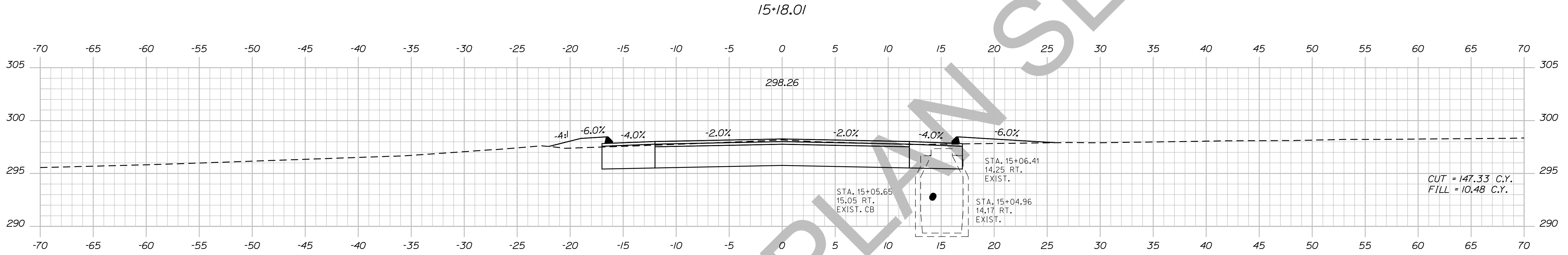
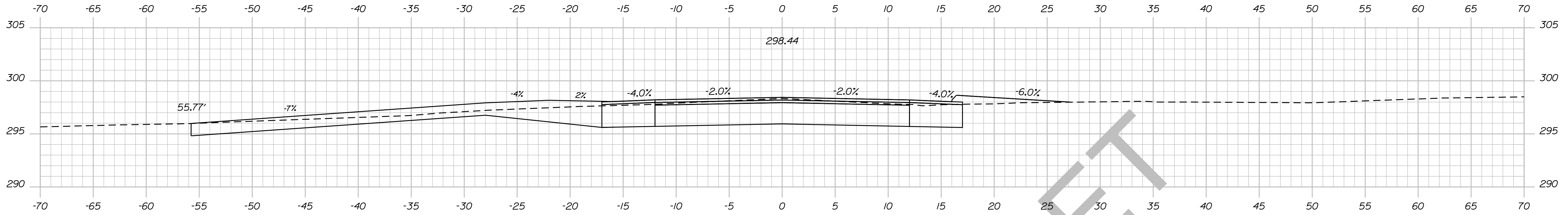

PROJ. MANAGER	BY	DATE
ERNEST MARTIN	TRAVIS WHEELER	
DESIGN-DETAILED	SIGNATURE	
CHECKED-REVIEWED		
DESIGN-DETAILED	P.E. NUMBER	
REVISIONS 1		
REVISIONS 2		
REVISIONS 3		
REVISIONS 4		
FIELD CHANGES	DATE	

DEXTER  
ROUTE 7  
CROSS SECTIONS

Date: 5/19/2014

Username: Allee.Mousseau

Division: HIGHWAY

Filename: ... \038\_XSECT\_15+50\_005.dgn

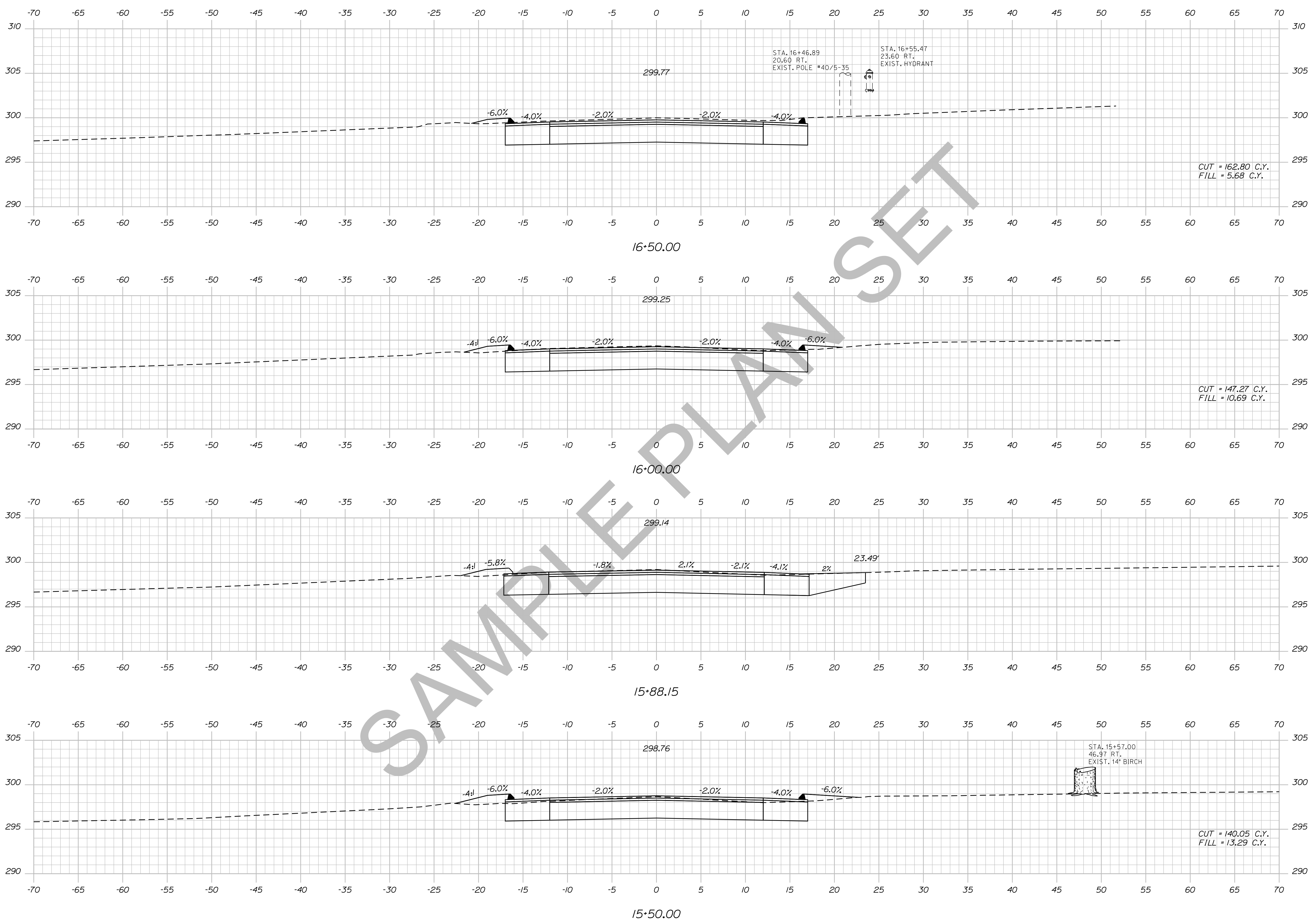

STATE OF MAINE  
DEPARTMENT OF TRANSPORTATION  
018246-00  
PIN 18246.00  
HIGHWAY PLANS

PROJ. MANAGER	BY	DATE	SIGNATURE	P.E. NUMBER	DATE
ERNEST MARTIN	TRAVIS WHEELER				
DESIGN-DETAILED					
CHECKED-REVIEWED					
DESIGN-DETAILED					
REVISIONS 1					
REVISIONS 2					
REVISIONS 3					
REVISIONS 4					
FIELD CHANGES					

DEXTER  
ROUTE 7  
CROSS SECTIONS

SHEET NUMBER  
**38**  
OF 15



Date: 5/19/2014

Username: Alee.Mousseau

Division: HIGHWAY

Filename: ... \039\_XSECT\_17+00\_006.dgn

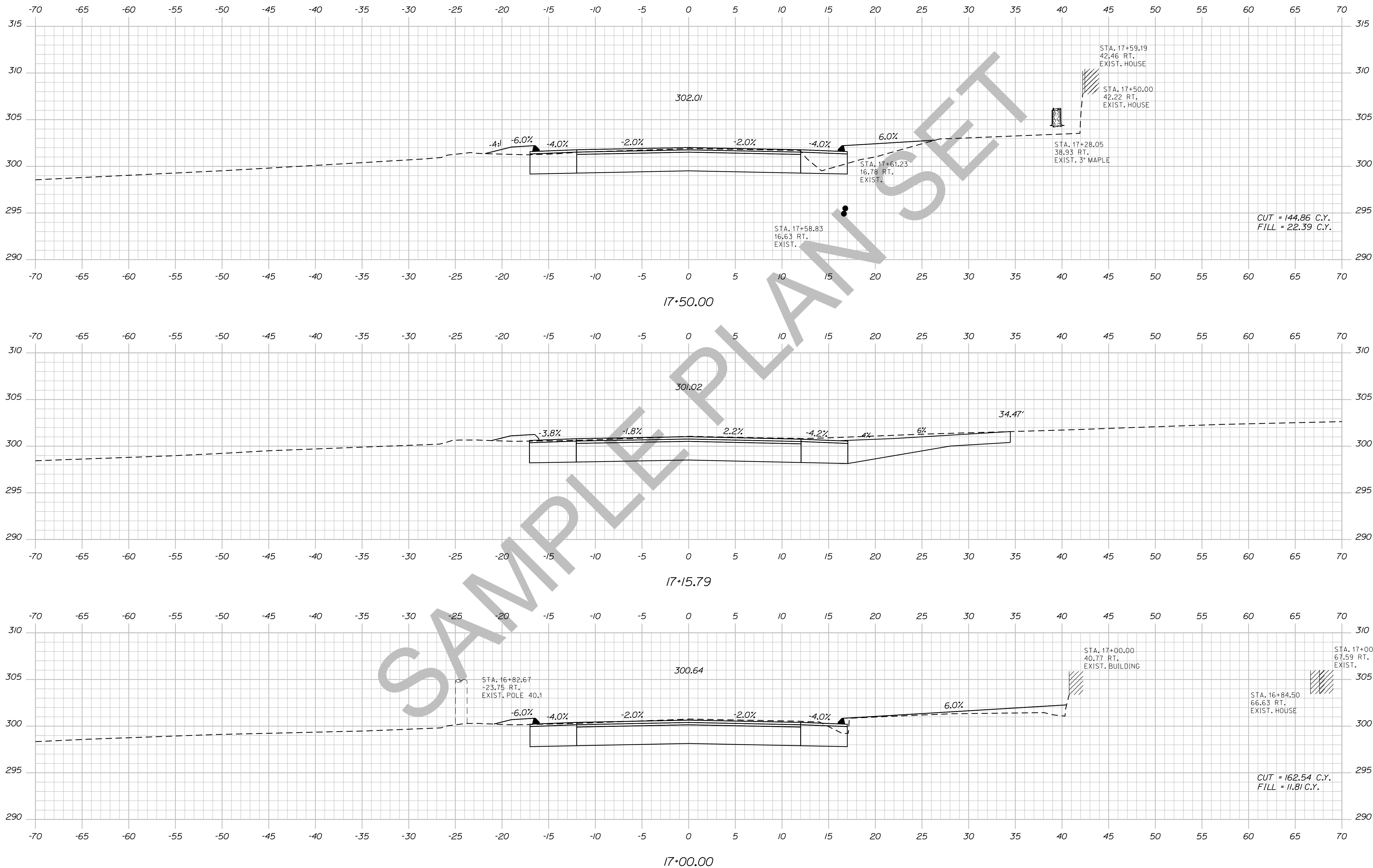

STATE OF MAINE		DEPARTMENT OF TRANSPORTATION		PIN 18246.00		HIGHWAY PLANS	
018246.00		SIGNATURE		P.E. NUMBER		DATE	
PROJ. MANAGER	ERNEST MARTIN	BY	TRAVIS WHEELER	DESIGN-DETAILED	TRAVIS WHEELER	REVISIONS 1	
CHECKED-REVIEWED		DESIGN-DETAILED		DESIGN-DETAILED		REVISIONS 2	
DESIGN-DETAILED		DESIGN-DETAILED		DESIGN-DETAILED		REVISIONS 3	
DESIGN-DETAILED		DESIGN-DETAILED		DESIGN-DETAILED		REVISIONS 4	
DESIGN-DETAILED		DESIGN-DETAILED		DESIGN-DETAILED		FIELD CHANGES	
DEXTER ROUTE 7				CROSS SECTIONS			
SHEET NUMBER				39			
				OF 15			

Date: 5/19/2014

Username: Alee.Mousseau

Division: HIGHWAY

Filename: ... \040\_XSECT\_17-74\_007.dgn

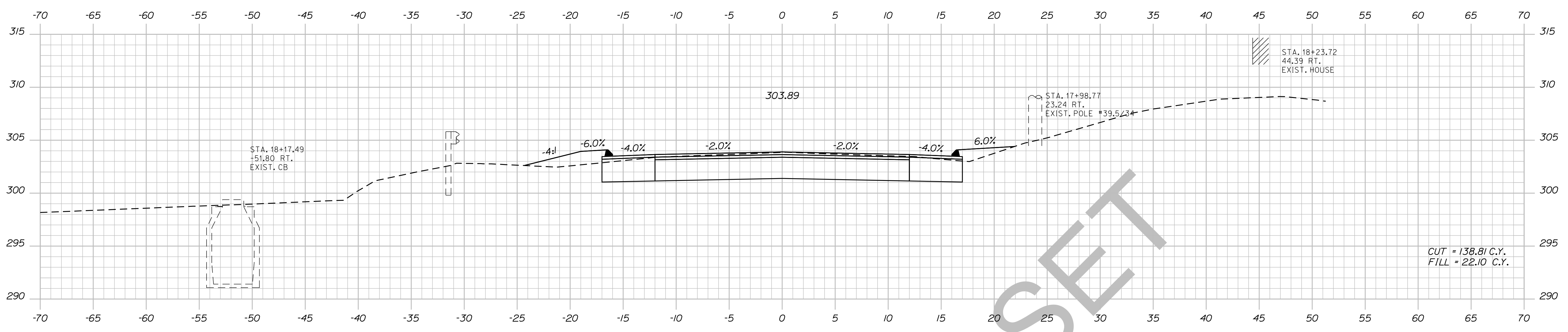

18+00.00

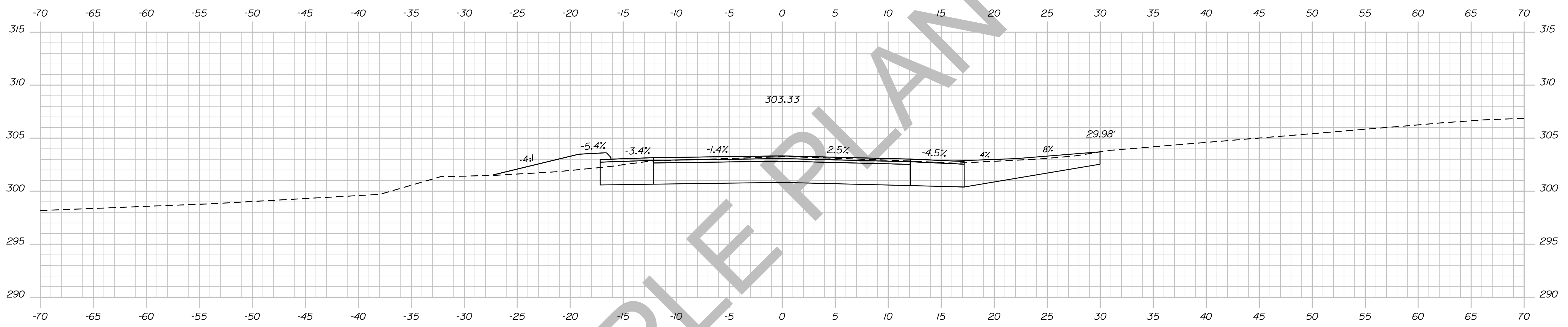

17+86.47

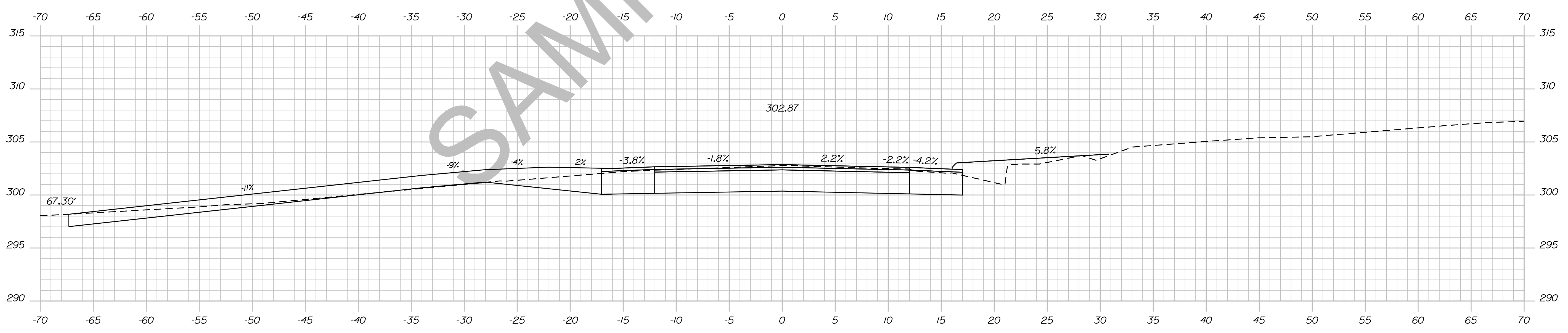

17+74.48

STATE OF MAINE  
DEPARTMENT OF TRANSPORTATION  
018246-00  
PIN 18246.00  
HIGHWAY PLANS

DESIGN DETAILED	CHECKED/REVIEWED	DESIGN DETAILED	REVISIONS 1	REVISIONS 2	REVISIONS 3	REVISIONS 4	FIELD CHANGES
TRAVIS WHEEL							
PROJ. MANAGER	ERNEST MARTIN	BY					
DATE							
		SIGNATURE					
		P.E. NUMBER					
		DATE					

DEXTER  
ROUTE 7  
CROSS SECTIONS

SHEET NUMBER  
**40**  
OF 15

Date: 5/19/2014

Username: Ailee.Mousseau

Division: HIGHWAY

Filename: ... \041\_XSECT\_18+50\_008.dgn

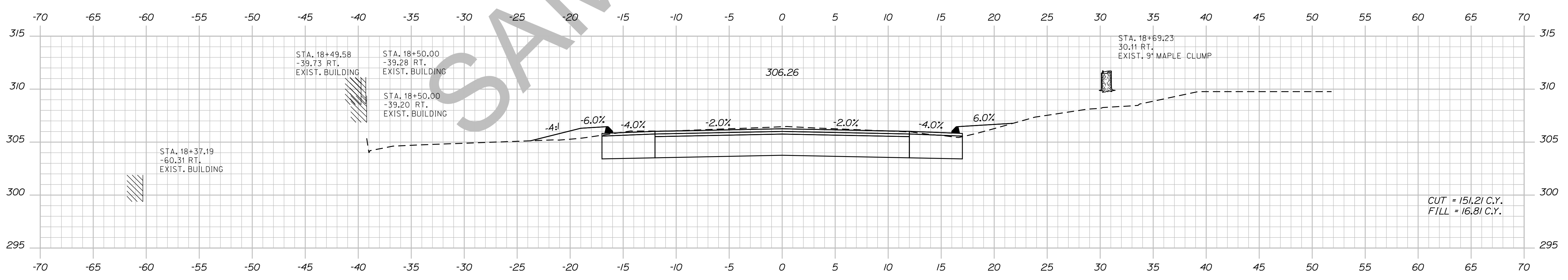
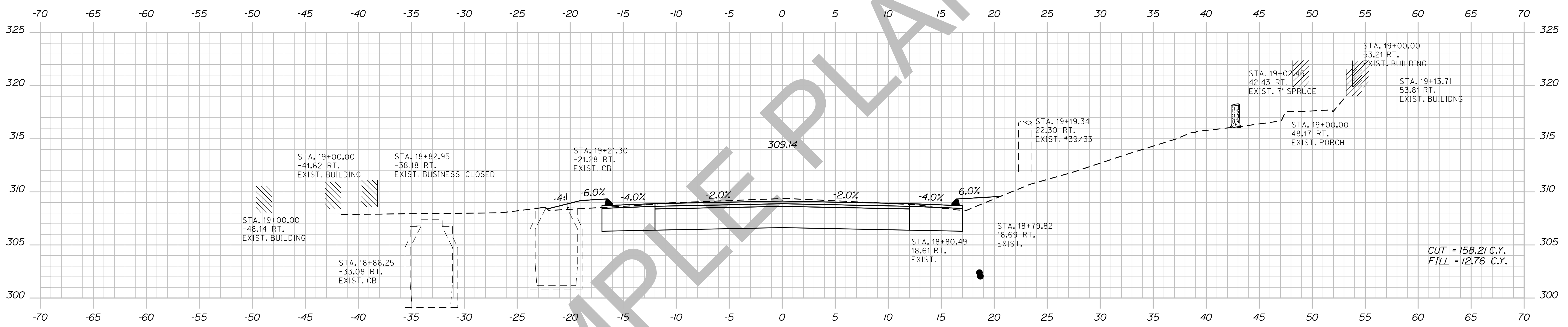
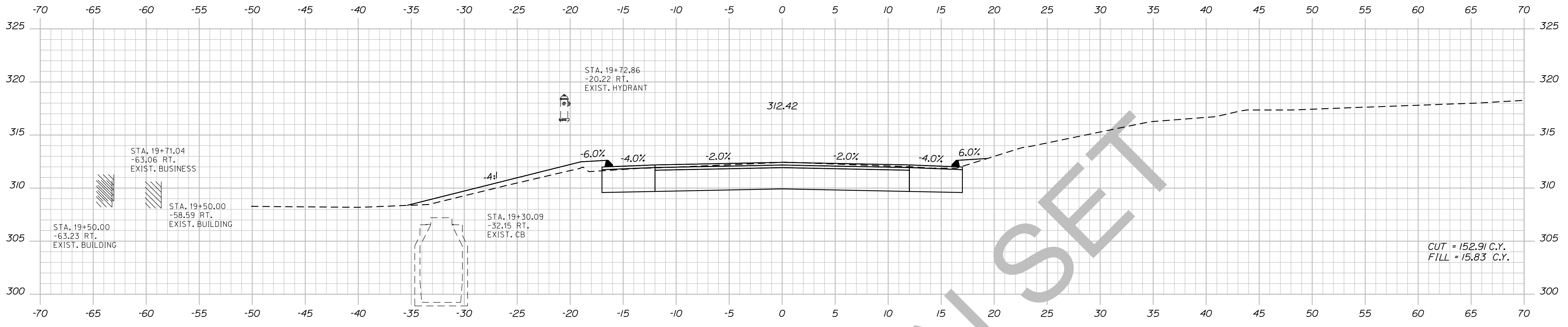

STATE OF MAINE  
DEPARTMENT OF TRANSPORTATION  
018246.00  
PIN 18246.00  
HIGHWAY PLANS

PROJ. MANAGER	BY	DATE	SIGNATURE	P.E. NUMBER	DATE
ERNEST MARTIN	TRAVIS WHEELER				
DESIGN-DETAILED					
CHECKED-REVIEWED					
DESIGN-DETAILED					
REVISIONS 1					
REVISIONS 2					
REVISIONS 3					
REVISIONS 4					
FIELD CHANGES					

DEXTER  
ROUTE 7  
CROSS SECTIONS

SHEET NUMBER  
41  
OF 15

Sta. 18+50.00 to Sta. 19+50.00



Date: 5/19/2014

Username: Alee.Mousseau

Division: HIGHWAY

Filename: ... \042\_XSECT\_19-96\_009.dgn

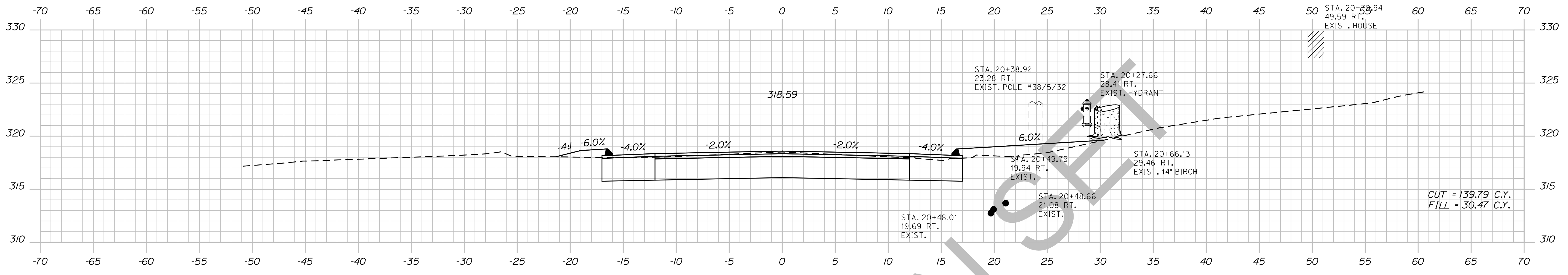

20+50.00



20+00.00

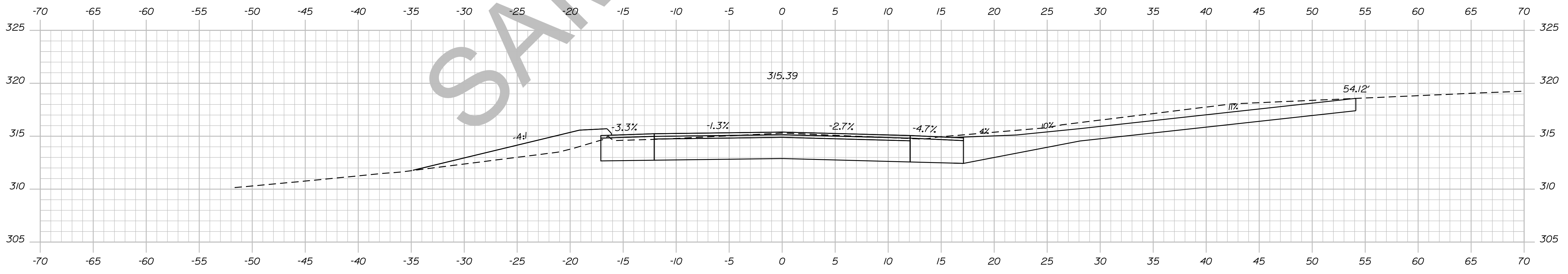

19+96.64

STATE OF MAINE  
DEPARTMENT OF TRANSPORTATION  
018246.00  
PIN 18246.00  
HIGHWAY PLANS

DESIGN/REVIEW	SIGNATURE	P.E. NUMBER	DATE
DESIGNED			
CHECKED			
DESIGNED			
REVISIONS			
REVISIONS			
REVISIONS			
REVISIONS			
FIELD CHANGES			

DEXTER  
ROUTE 7  
CROSS SECTIONS

SHEET NUMBER  
42  
OF 15

Date: 5/19/2014

Username: Alee.Mousseau

Division: HIGHWAY

Filename: ... \043\_XSECT\_20+71\_010.dgn

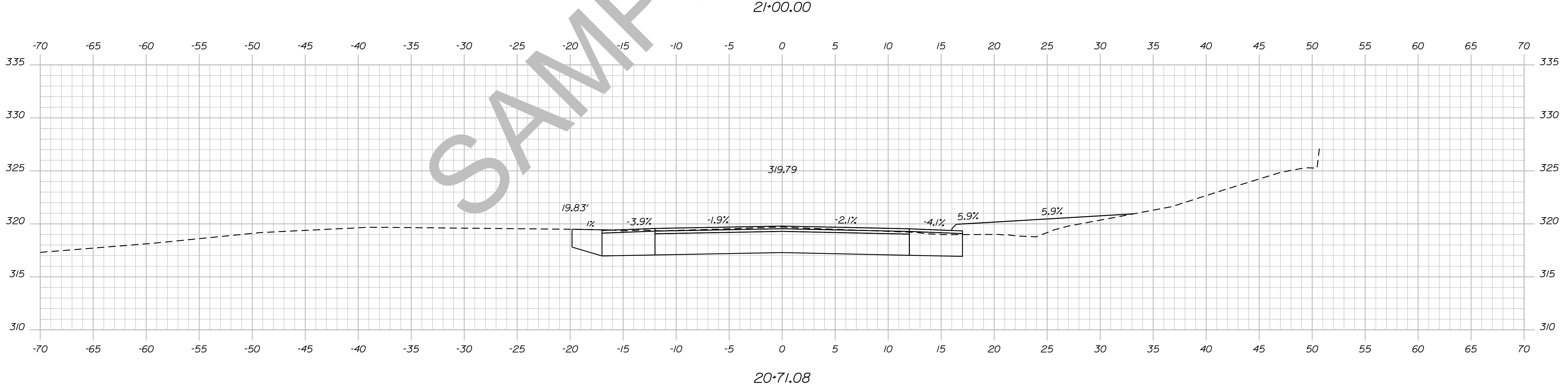
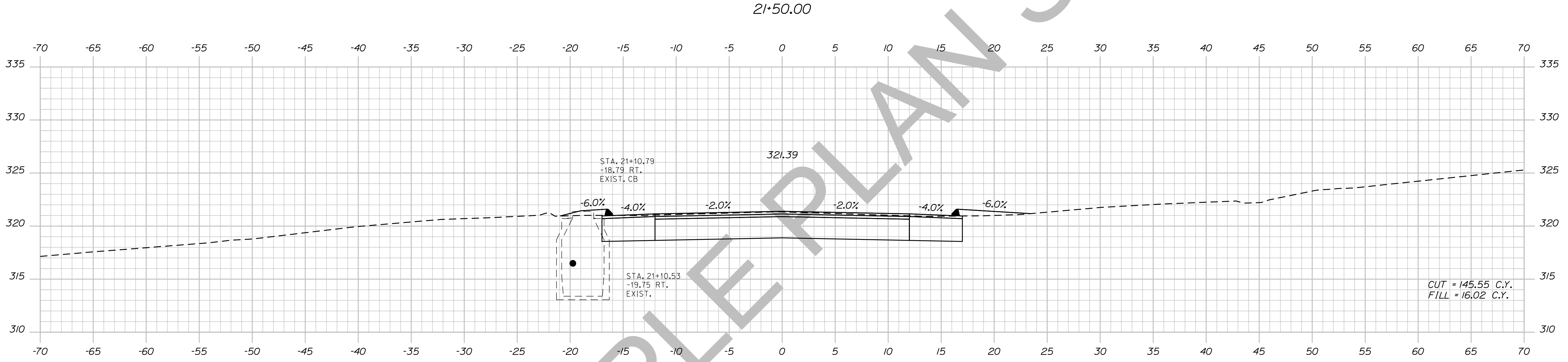
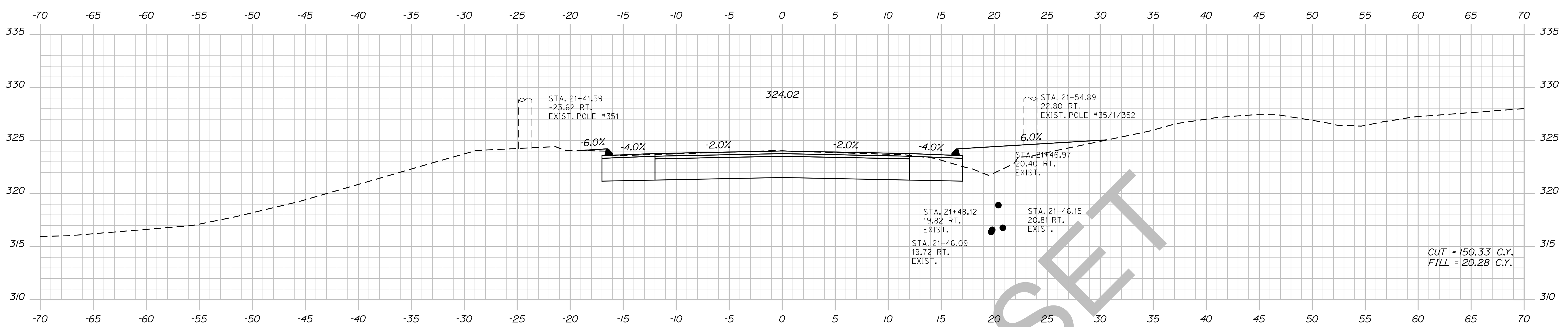

STATE OF MAINE DEPARTMENT OF TRANSPORTATION		018246.00		PIN 18246.00		HIGHWAY PLANS	
PROJ. MANAGER	ERNEST MARTIN	BY	DATE	SIGNATURE	P.E. NUMBER	DATE	
DESIGN-DETAILED	TRAVIS WHEEL						
CHECKED-REVIEWED							
DESIGNS DET AILED							
DESIGNS DET AILED							
REVISIONS 1							
REVISIONS 2							
REVISIONS 3							
REVISIONS 4							
FIELD CHANGES							
DEXTER ROUTE 7				CROSS SECTIONS			
SHEET NUMBER				43			
				OF 15			

Date: 5/19/2014

Username: Alee.Mousseau

Division: HIGHWAY

Filename: ... \044\_XSECT\_22+00\_011.dgn

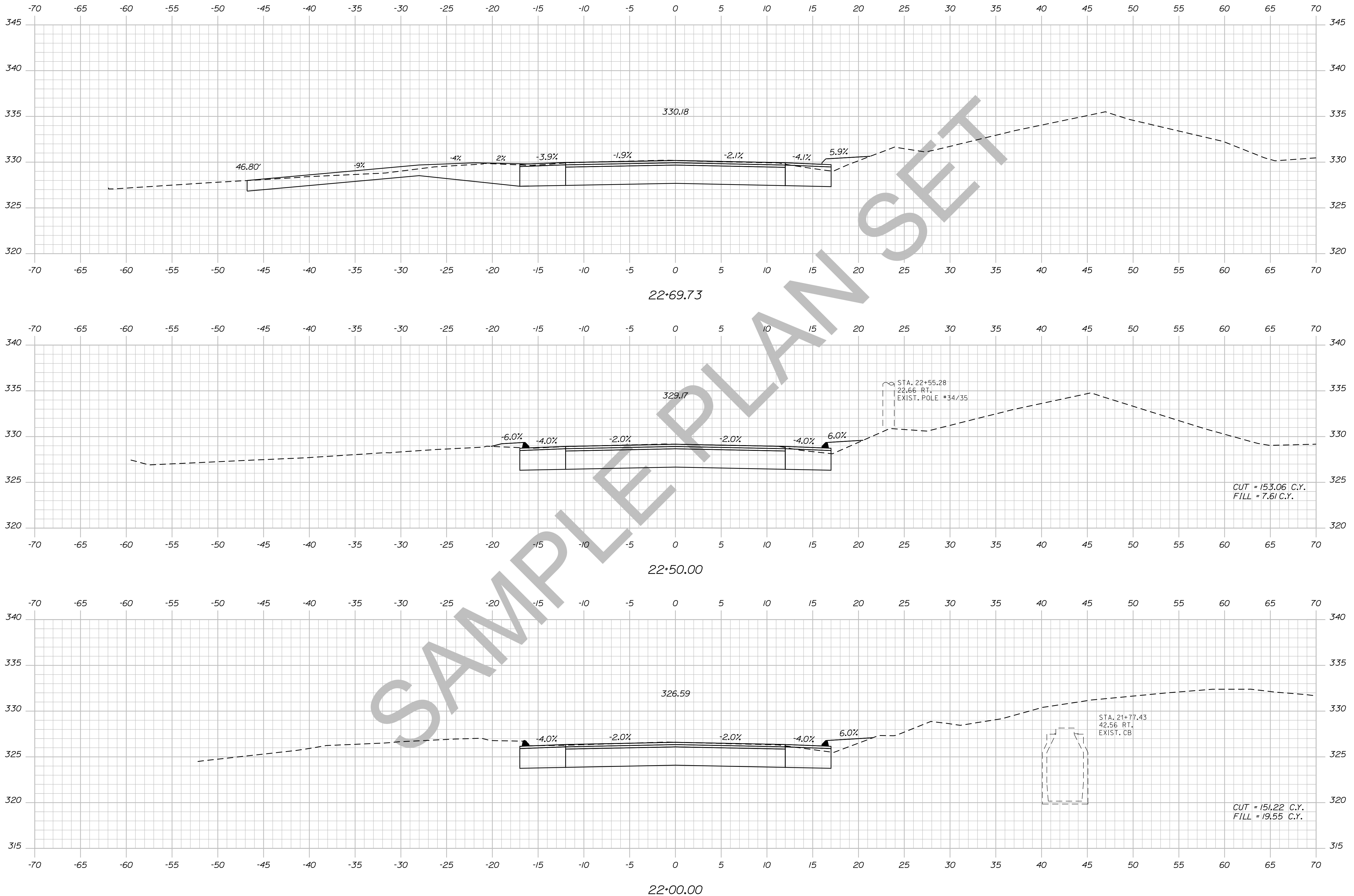

STATE OF MAINE  
DEPARTMENT OF TRANSPORTATION  
018246.00  
PIN  
18246.00  
HIGHWAY PLANS

DESIGN-DETAILED	DATE
CHECKED-REVIEWED	BY
DESIGN-DETAILED	PROJ. MANAGER
REVISIONS 1	ERNEST MARTIN
REVISIONS 2	TRAVIS WHEELER
REVISIONS 3	
REVISIONS 4	
FIELD CHANGES	

SIGNATURE	P.E. NUMBER	DATE

DEXTER  
ROUTE 7  
CROSS SECTIONS

SHEET NUMBER  
44  
OF 15



Date: 5/19/2014

Username: Alee.Mousseau

Division: HIGHWAY

Filename: ... \045\_XSECT\_23+00\_012.dgn

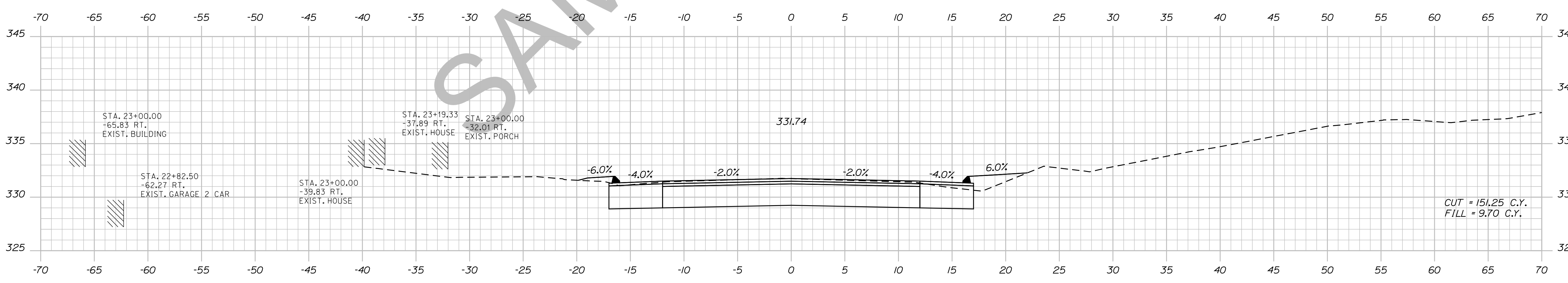
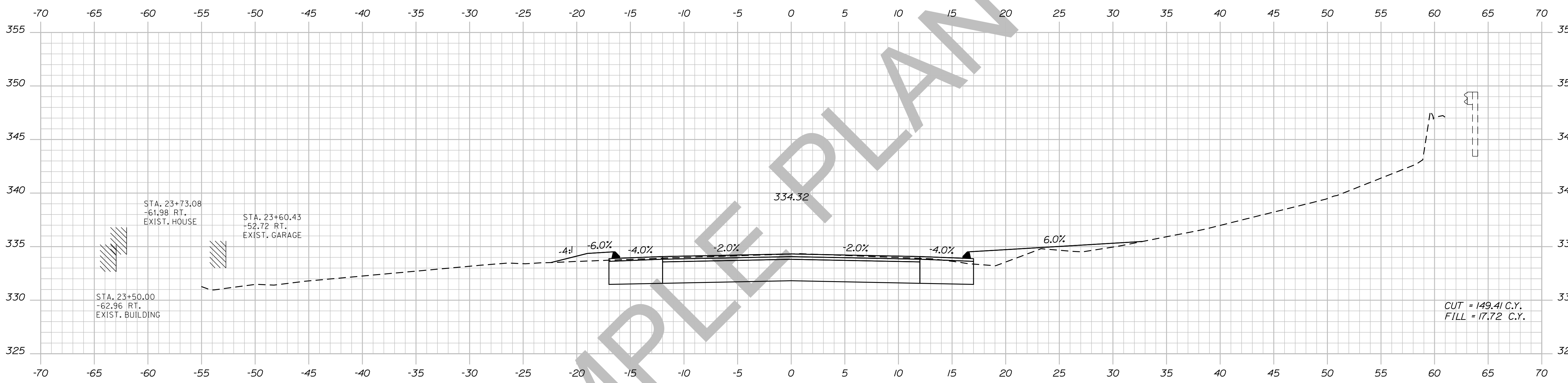

STATE OF MAINE  
 DEPARTMENT OF TRANSPORTATION  
 018246.00  
 PIN 18246.00  
 HIGHWAY PLANS

DESIGN/REVIEWED	DATE
PROJ. MANAGER ERNEST MARTIN	
CHECKED/REVIEWED TRAVIS WHEELER	
DESIGN/DET ALEA MOUSSEAU	
DESIGN/DET ALEA MOUSSEAU	
REVISIONS 1	
REVISIONS 2	
REVISIONS 3	
REVISIONS 4	
FIELD CHANGES	

DEXTER  
 ROUTE 7  
 CROSS SECTIONS

SHEET NUMBER  
 45  
 OF 15

Date: 5/19/2014

Username: Alee.Mousseau

Division: HIGHWAY

Filename: ... \046\_XSECT\_24+00\_013.dgn

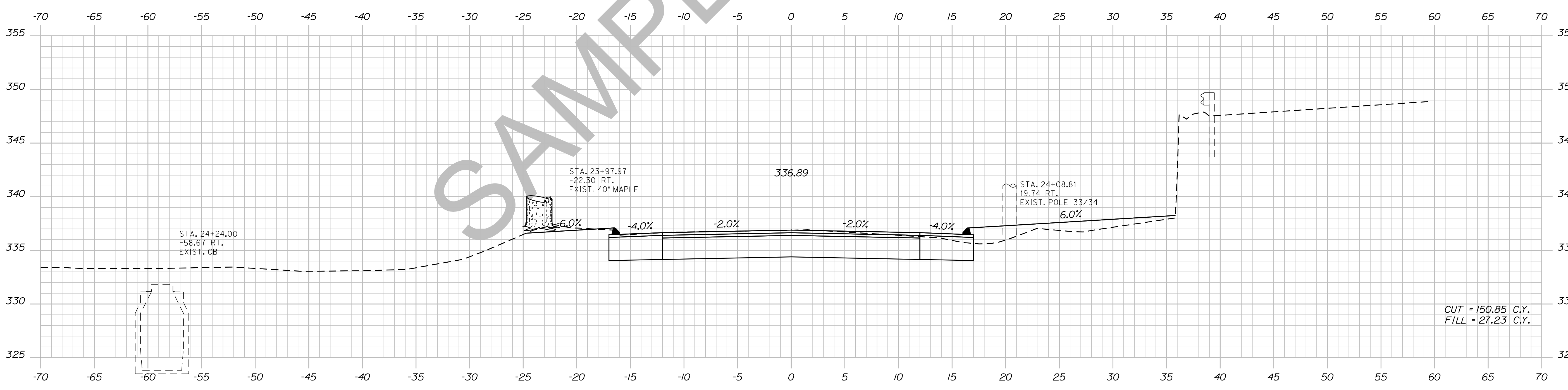
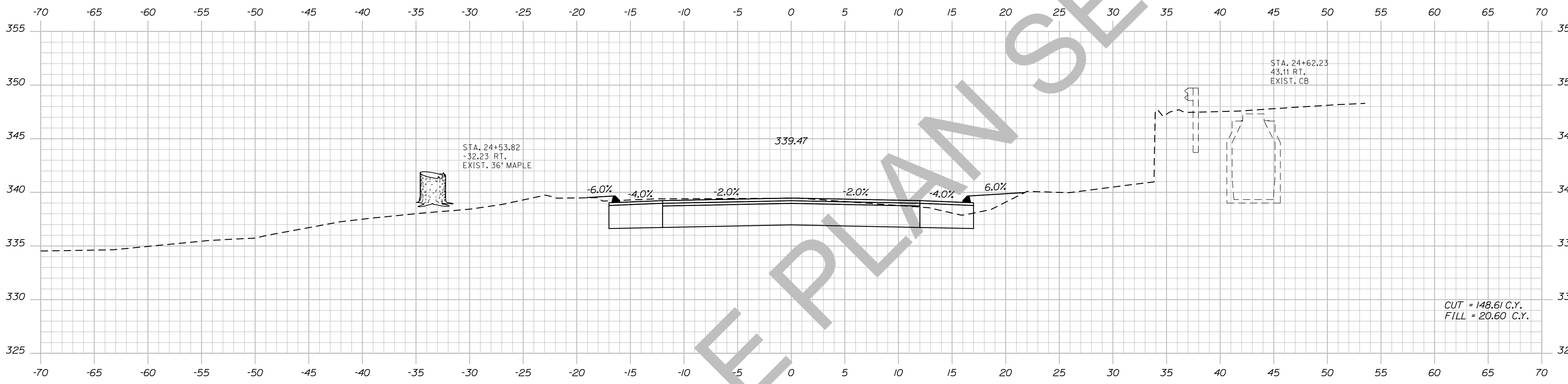

SAMPLE PLAN SET

STATE OF MAINE  
DEPARTMENT OF TRANSPORTATION  
018246.00  
PIN  
18246.00  
HIGHWAY PLANS

DESIGN/REVIEWED	DATE	SIGNATURE
PROJ. MANAGER ERNEST MARTIN		
CHECKED-TRAVIS WOLFE		
DESIGN/DET/TAILED		
DESIGN/DET/TAILED		
REVISIONS 1		
REVISIONS 2		
REVISIONS 3		
REVISIONS 4		
FIELD CHANGES		

DEXTER  
ROUTE 7  
CROSS SECTIONS

SHEET NUMBER  
**46**  
OF 15

Date: 5/19/2014

Username: Alee.Mousseau

Division: HIGHWAY

Filename: ... \047\_XSECT\_25+00\_014.dgn

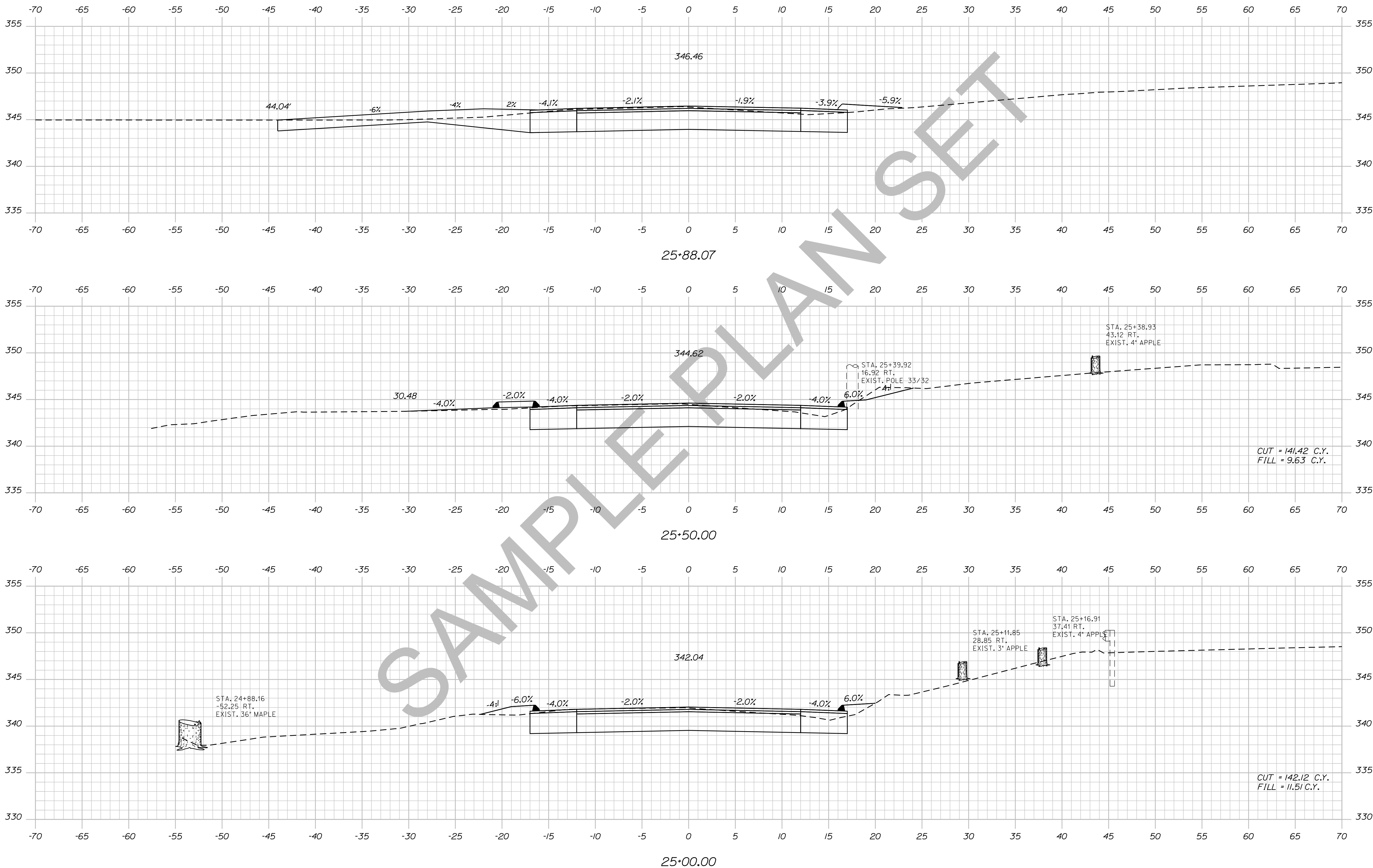

STATE OF MAINE DEPARTMENT OF TRANSPORTATION		018246.00	
SIGNATURE		P.E. NUMBER	
DATE		DATE	
PROJ. MANAGER	ERNEST MARTIN	BY	TRAVIS WHEEL
DESIGN/DETAILED		CHECKED/REVIEWED	
DESIGNS/DETAILED		DESIGNS/DETAILED	
REVISIONS 1		REVISIONS 1	
REVISIONS 2		REVISIONS 2	
REVISIONS 3		REVISIONS 3	
REVISIONS 4		REVISIONS 4	
FIELD CHANGES			
DEXTER ROUTE 7 CROSS SECTIONS			
SHEET NUMBER			
47			
OF 15			



Date: 5/19/2014

Username: Allee.Mousseau

Division: HIGHWAY

Filename: ... \048\_XSECT\_26+00\_015.dgn

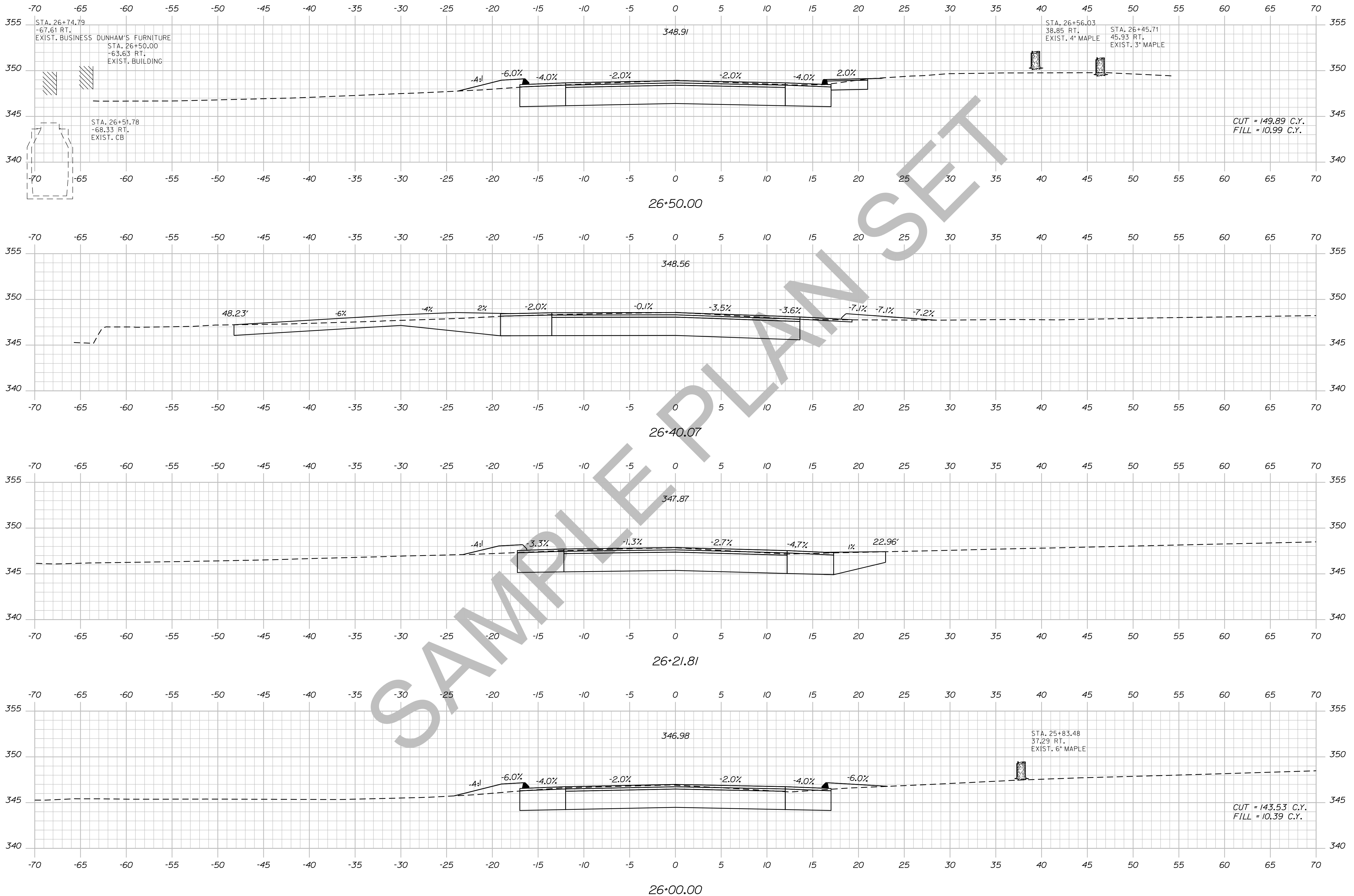

STATE OF MAINE  
DEPARTMENT OF TRANSPORTATION  
018246-00  
PIN 18246.00  
HIGHWAY PLANS

PROJ. MANAGER	BY	DATE	SIGNATURE	P.E. NUMBER	DATE
ERNEST MARTIN	TRAVIS WHEEL				
DESIGN-DETAILED					
CHECKED-REVIEWED					
DESIGN-DETAILED					
REVISIONS 1					
REVISIONS 2					
REVISIONS 3					
REVISIONS 4					
FIELD CHANGES					

DEXTER  
ROUTE 7  
CROSS SECTIONS

SHEET NUMBER  
**48**  
OF 15

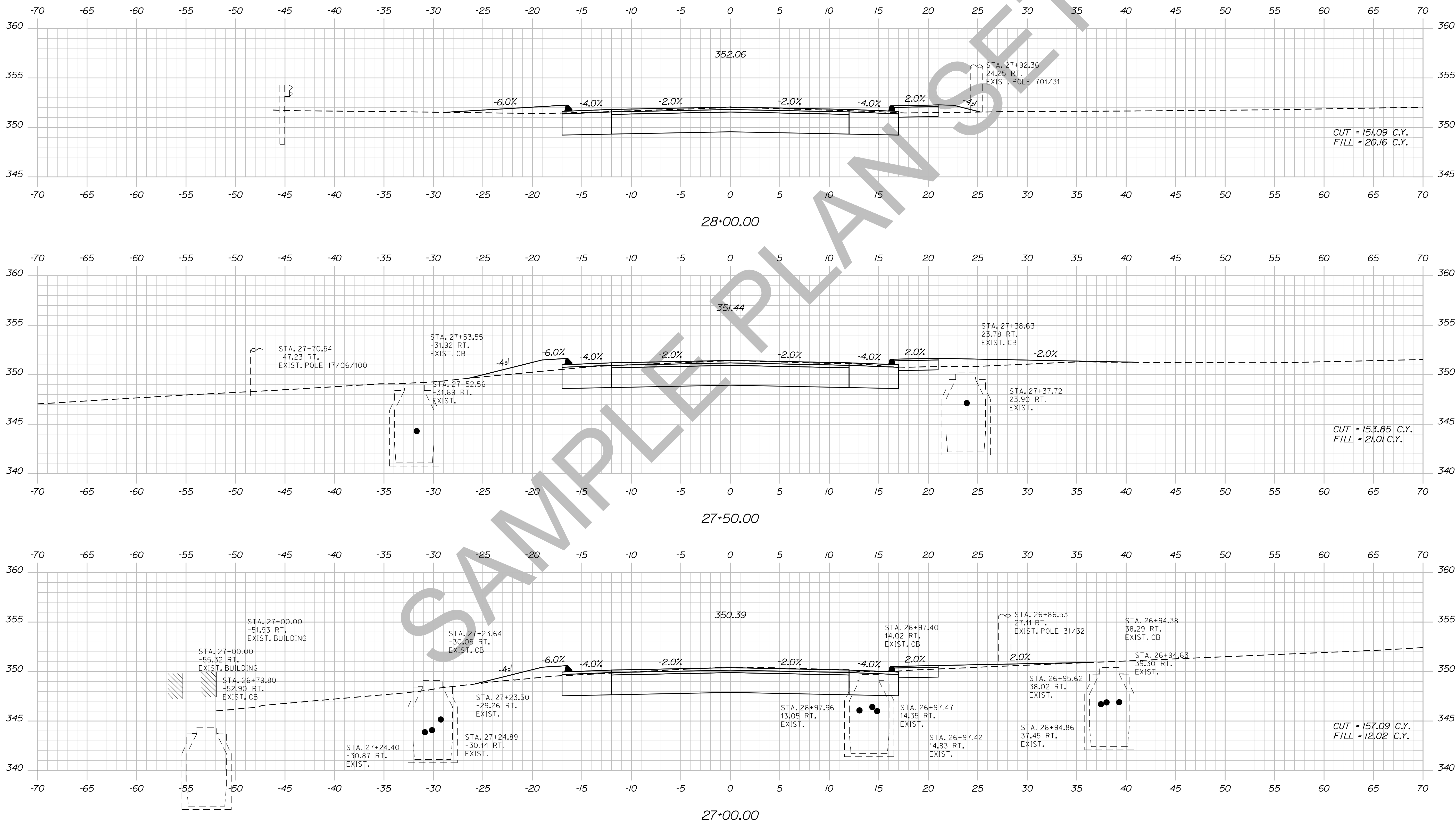

DATE	BY	PROJ. MGR.	CHECKED	DESIGNED	REVISIONS	SIGNATURE	P.E. NUMBER	DATE
	TRAVIS WHEELER	ERNEST MARTIN			1			
					2			
					3			
					4			

DEXTER  
ROUTE 7  
CROSS SECTIONS

Date: 5/19/2014

Username: Allee.Mousseau

Division: HIGHWAY

Filename: ... \050\_XSECT\_28+14\_017.dgn

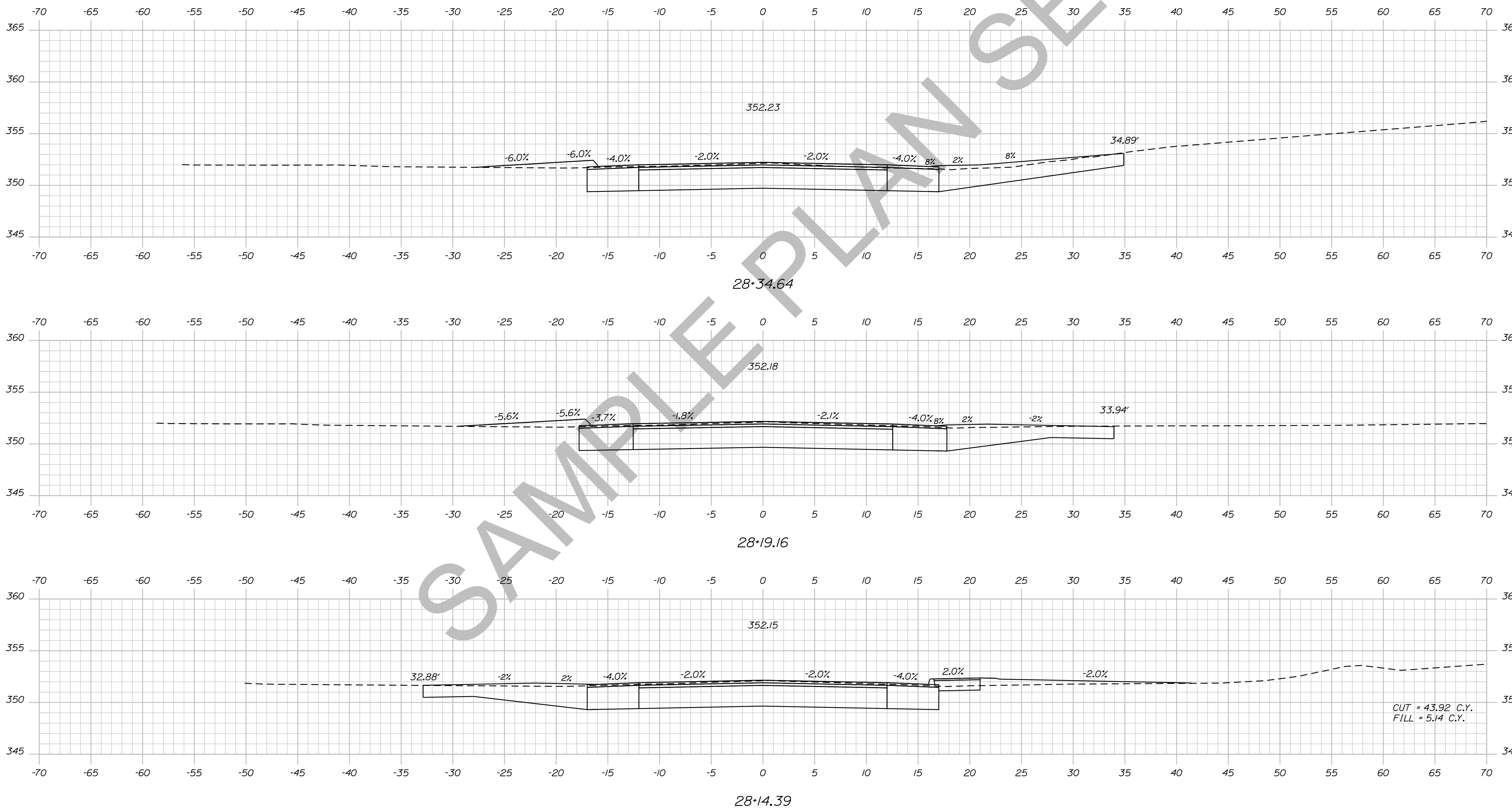

STATE OF MAINE  
DEPARTMENT OF TRANSPORTATION  
018246.00  
PIN  
18246.00  
HIGHWAY PLANS

PROJ. MANAGER	BY	DATE	SIGNATURE	P.E. NUMBER	DATE
ERNEST MARTIN	TRAVIS WHEELER				
DESIGN-DETAILED	CHECKED-REVIEWED	DESIGN-DETAILED	DESIGN-DETAILED	REVISIONS 1	REVISIONS 2
				REVISIONS 3	REVISIONS 4
				FIELD CHANGES	

DEXTER  
ROUTE 7  
CROSS SECTIONS

SHEET NUMBER  
**50**  
OF 15



Date: 5/19/2014

Username: Alee.Mousseau

Division: HIGHWAY

Filename: ... \051\_XSECT\_28+50\_01B.dgn

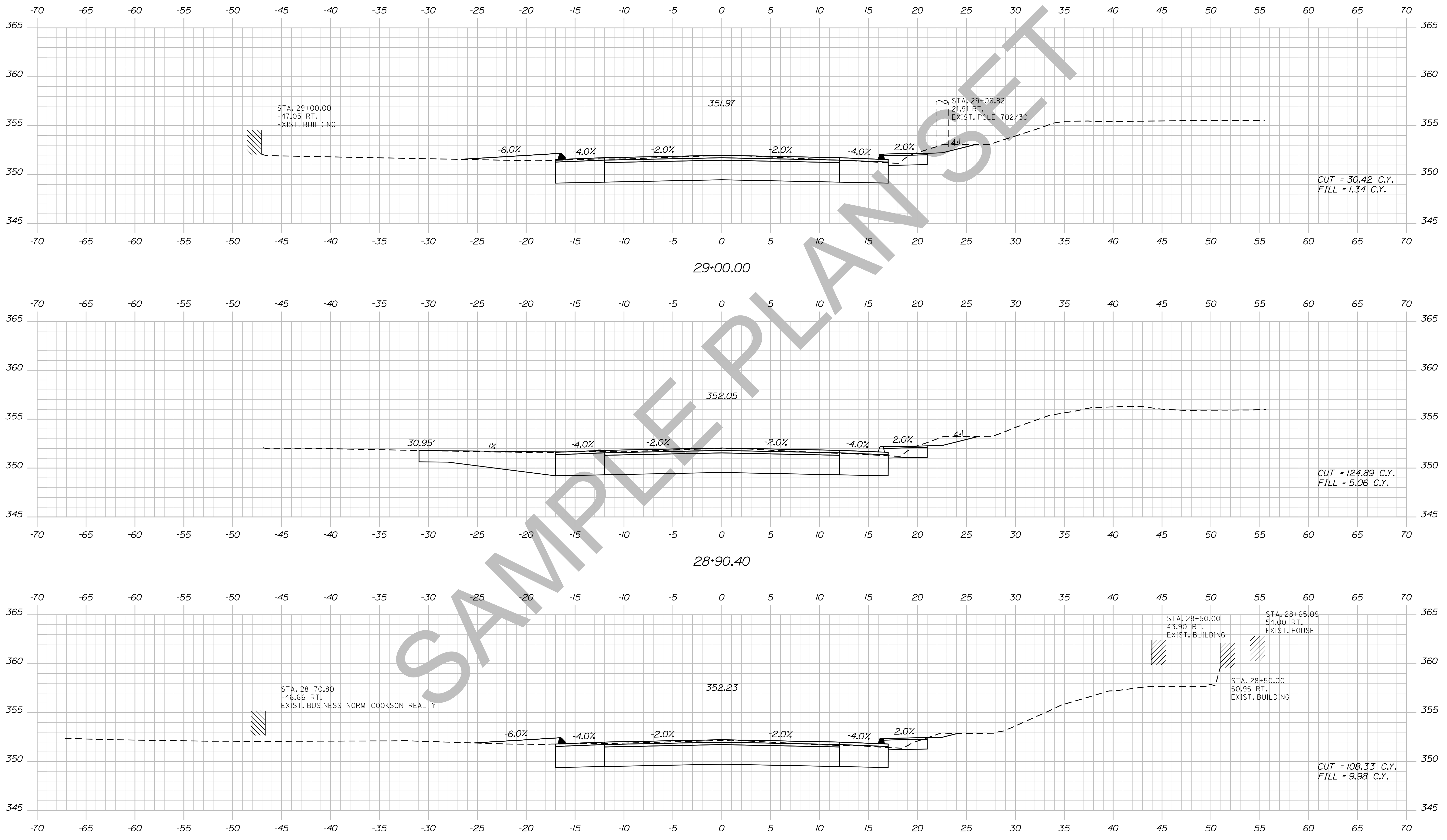

STATE OF MAINE  
DEPARTMENT OF TRANSPORTATION  
018246.00  
PIN 18246.00  
HIGHWAY PLANS

SIGNATURE  
P.E. NUMBER  
DATE

PROJ. MANAGER	BY	DATE
ERNEST MARTIN	TRAVIS WOLFE	

DESIGN-REVIEWED	CHECKED-REVIEWED	DESIGN-DETAILED

REVISIONS 1	REVISIONS 2	REVISIONS 3	REVISIONS 4	FIELD CHANGES

DEXTER  
ROUTE 7  
CROSS SECTIONS

SHEET NUMBER  
51  
OF 15

Date: 5/19/2014

Username: Allee.Mousseau

Division: HIGHWAY

Filename: ... \052\_XSECT\_29+34\_019.dgn

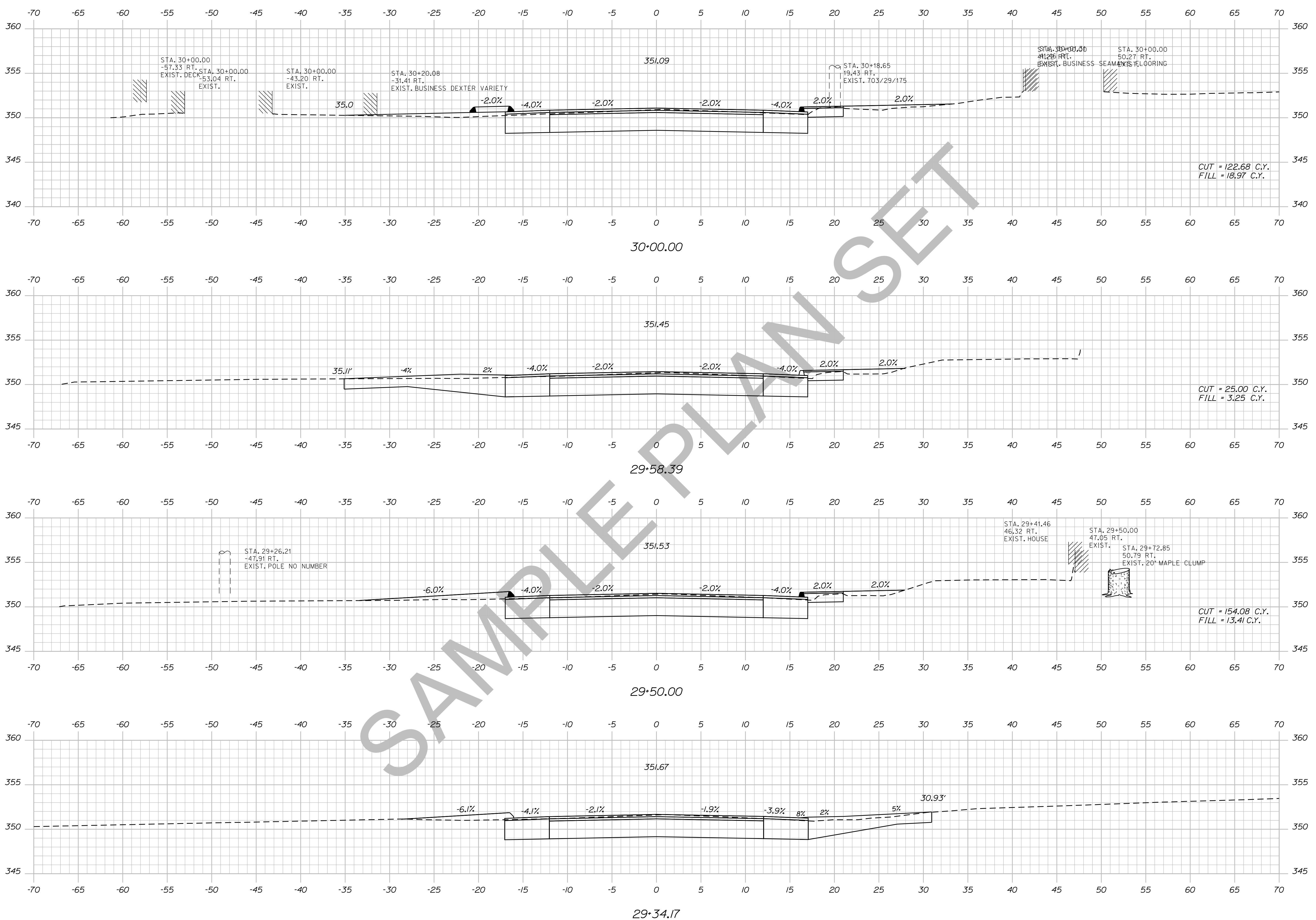

STATE OF MAINE  
DEPARTMENT OF TRANSPORTATION  
018246-00  
PIN 18246.00  
HIGHWAY PLANS

PROJ. MANAGER	BY	DATE	SIGNATURE	P.E. NUMBER	DATE
ERNEST MARTIN	TRAVIS WHEELER				

DESIGN-DETAILED  
CHECKED-REVIEWED  
DESIGNS-DETAILED  
REVISIONS 1  
REVISIONS 2  
REVISIONS 3  
REVISIONS 4  
FIELD CHANGES

DEXTER ROUTE 7  
CROSS SECTIONS

SHEET NUMBER  
52  
OF 15

Date: 5/19/2014

Username: Alee.Mousseau

Division: HIGHWAY

Filename: ... \053\_XSECT\_30+50\_020.dgn

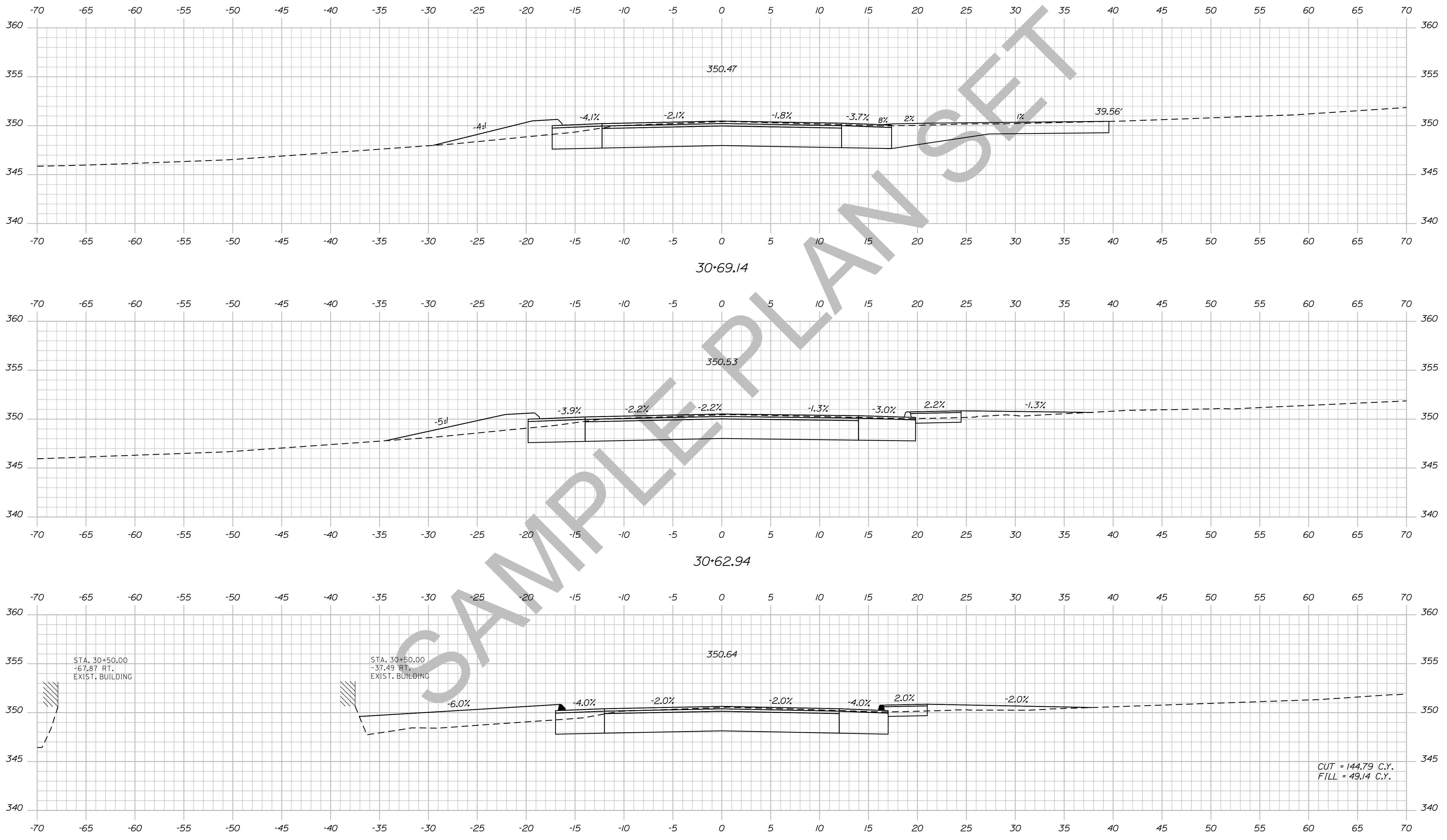

STATE OF MAINE  
DEPARTMENT OF TRANSPORTATION  
018246-00  
PIN 18246.00  
HIGHWAY PLANS

PROJ. MANAGER	ERNEST MARTIN	BY	DATE
DESIGN-DETAILED	TRAVIS WOLFE		
CHECKED-REVIEWED			
DESIGN-DETAILED			
REVISIONS 1			
REVISIONS 2			
REVISIONS 3			
REVISIONS 4			
FIELD CHANGES			

DEXTER  
ROUTE 7  
CROSS SECTIONS

SHEET NUMBER  
**53**  
OF 15

Date: 5/19/2014

Username: Alee.Mousseau

Division: HIGHWAY

Filename: ... \054\_XSECT\_31+00\_021.dgn

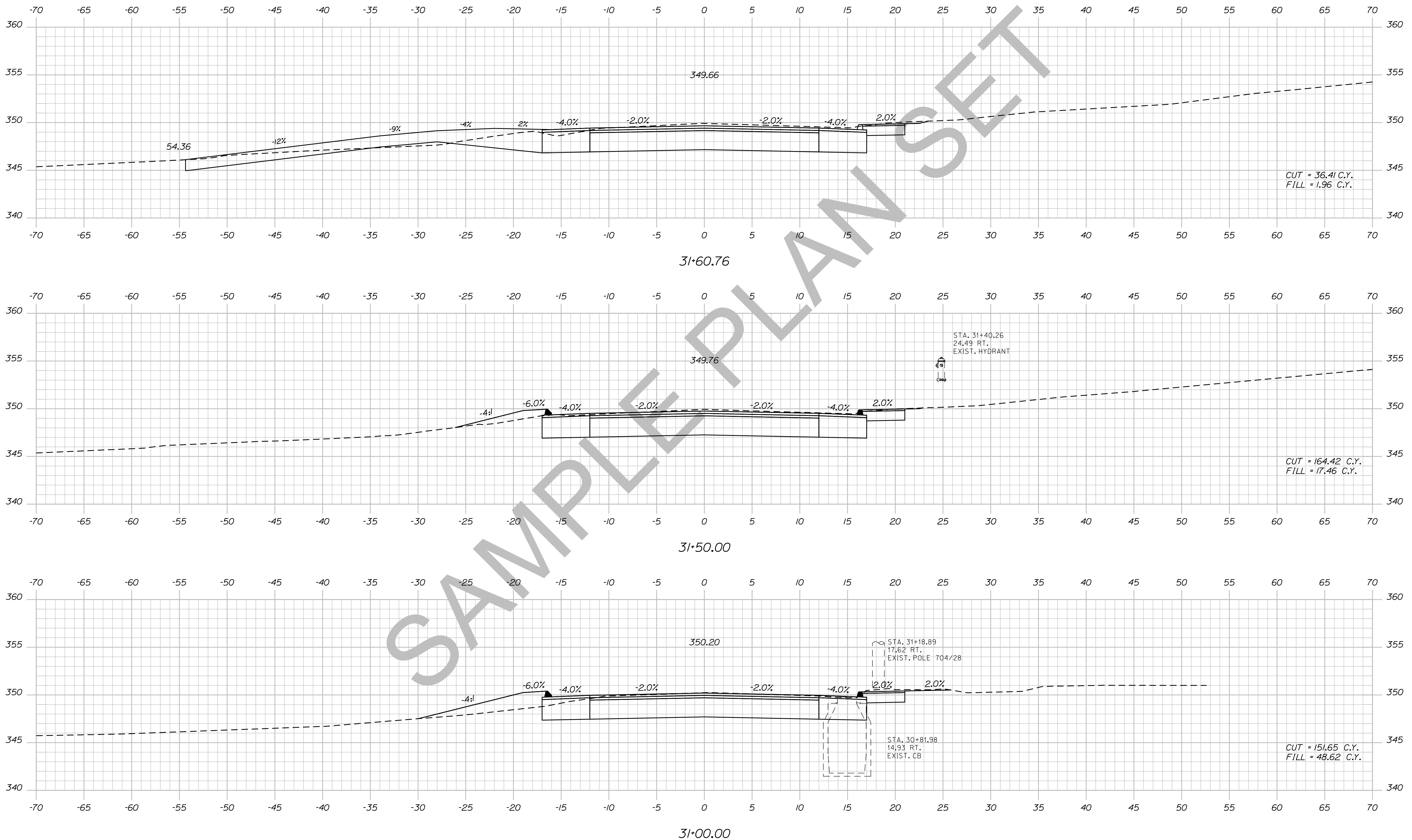

STATE OF MAINE DEPARTMENT OF TRANSPORTATION		018246.00	PIN 18246.00	HIGHWAY PLANS
	SIGNATURE	P.E. NUMBER	DATE	
PROJ. MANAGER ERNEST MARTIN	BY TRAVIS WHEEL	DESIGN-DETAILED	DESIGN-REVIEWED	DATE
DESIGNS DET AILED	DESIGNS DET AILED	REVISIONS 1	REVISIONS 2	REVISIONS 3
REVISIONS 4	FIELD CHANGES			
DEXTER ROUTE 7		CROSS SECTIONS		
SHEET NUMBER		54		
		OF 15		



Date: 5/19/2014

Username: Alee.Mousseau

Division: HIGHWAY

Filename: ... \055\_XSECT\_31+64\_022.dgn

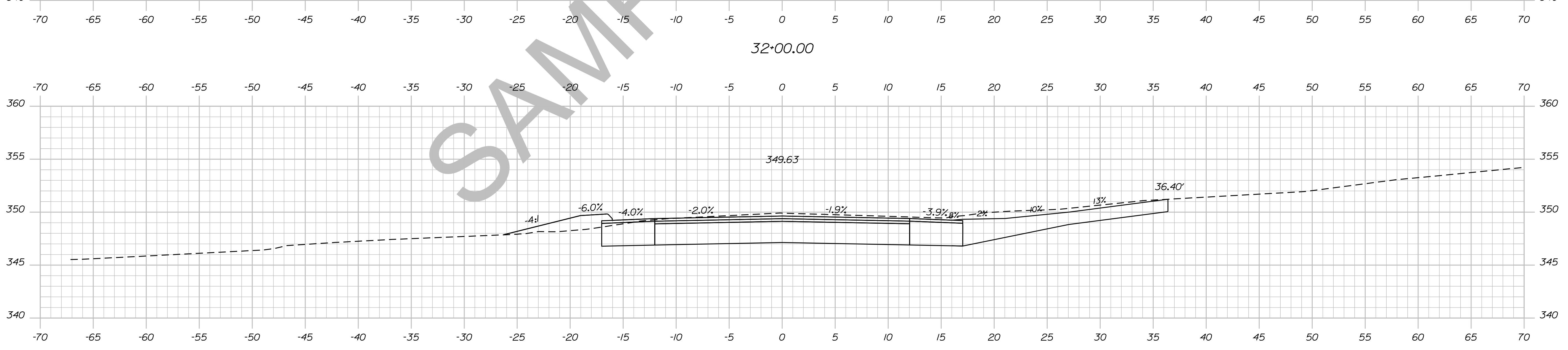
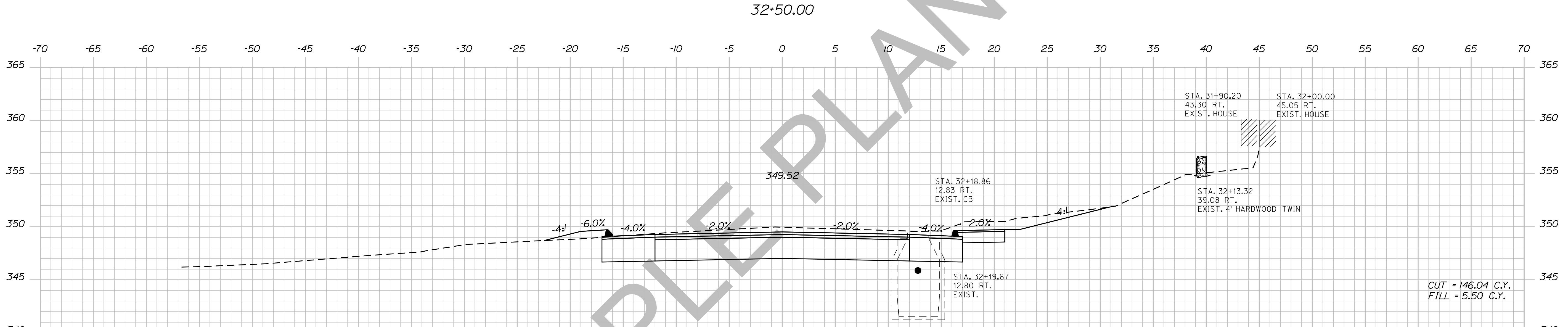
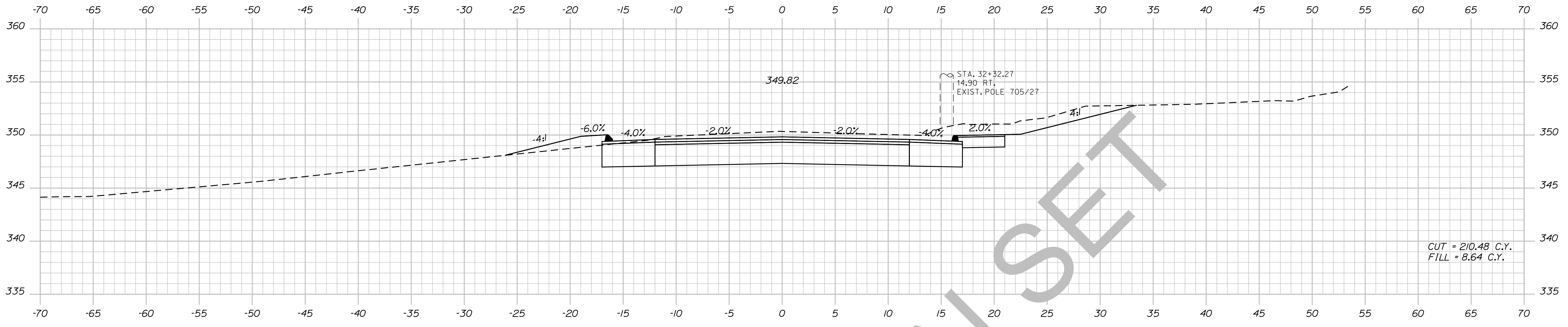

STATE OF MAINE  
DEPARTMENT OF TRANSPORTATION  
018246-00  
PIN 18246.00  
HIGHWAY PLANS

DESIGN	DATE	BY	PROJ. MGR.	ERNEST MARTIN
DESIGNED				
CHECKED-REVIEWED		TRAVIS WOLFE		
DESIGNED-REVIEWED				
DESIGNED-DET AILED				
REVISIONS 1				
REVISIONS 2				
REVISIONS 3				
REVISIONS 4				
FIELD CHANGES				

DEXTER  
ROUTE 7  
CROSS SECTIONS

SHEET NUMBER  
**55**  
OF 15

Date: 5/19/2014

Username: Alee.Mousseau

Division: HIGHWAY

Filename: ... \056\_XSECT\_32+75\_023.dgn

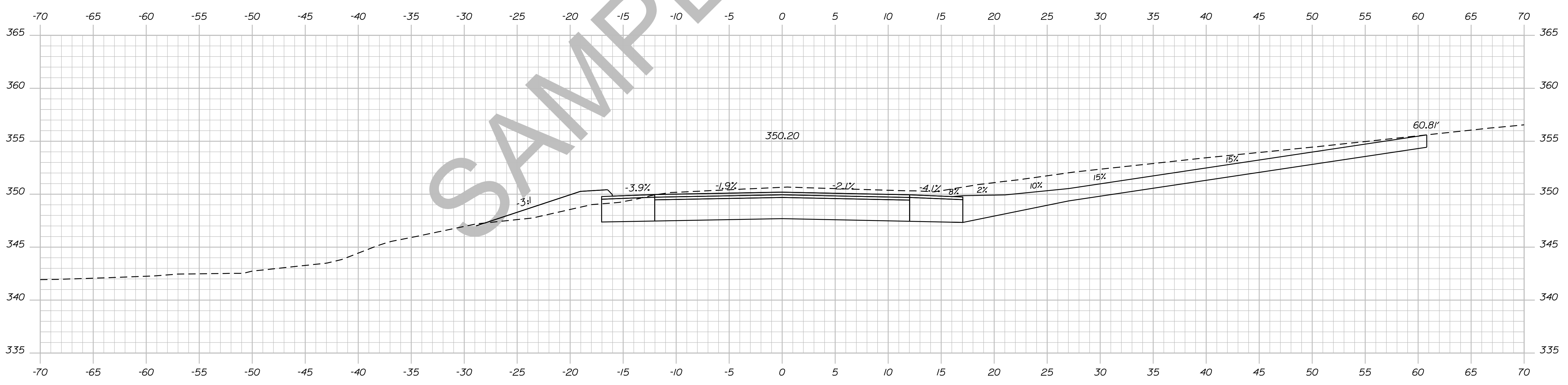
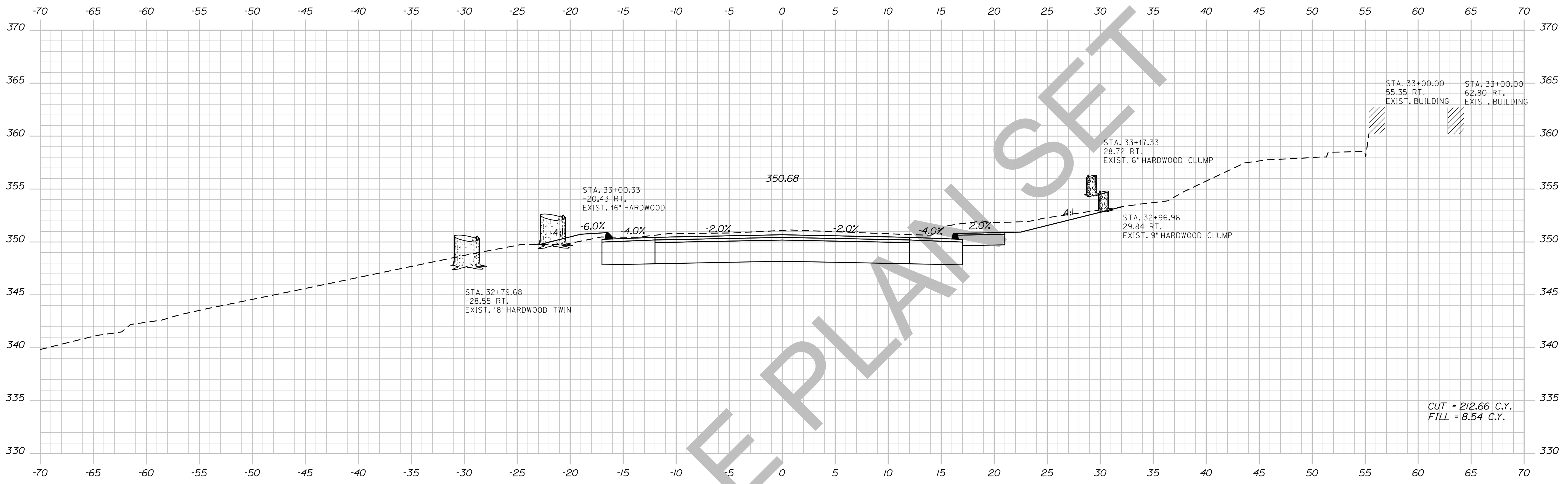

STATE OF MAINE  
DEPARTMENT OF TRANSPORTATION  
018246.00  
PIN  
18246.00  
HIGHWAY PLANS

PROJ. MANAGER	ERNEST MARTIN	BY	DATE
DESIGN-DETAILED	TRAVIS WEL		
CHECKED-REVIEWED			
DESIGN-DETAILED			
DESIGN-DETAILED			
REVISIONS 1			
REVISIONS 2			
REVISIONS 3			
REVISIONS 4			
FIELD CHANGES			

DEXTER  
ROUTE 7  
CROSS SECTIONS

SHEET NUMBER  
**56**  
OF 15

Date: 5/19/2014

Username: Alee.Mousseau

Division: HIGHWAY

Filename: ... \057\_XSECT\_33+40\_024.dgn

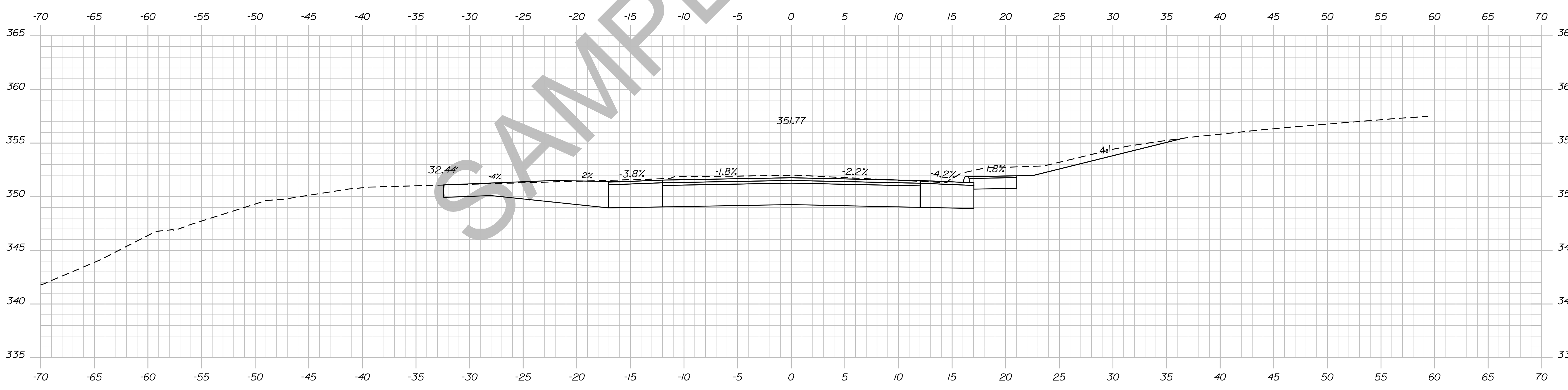
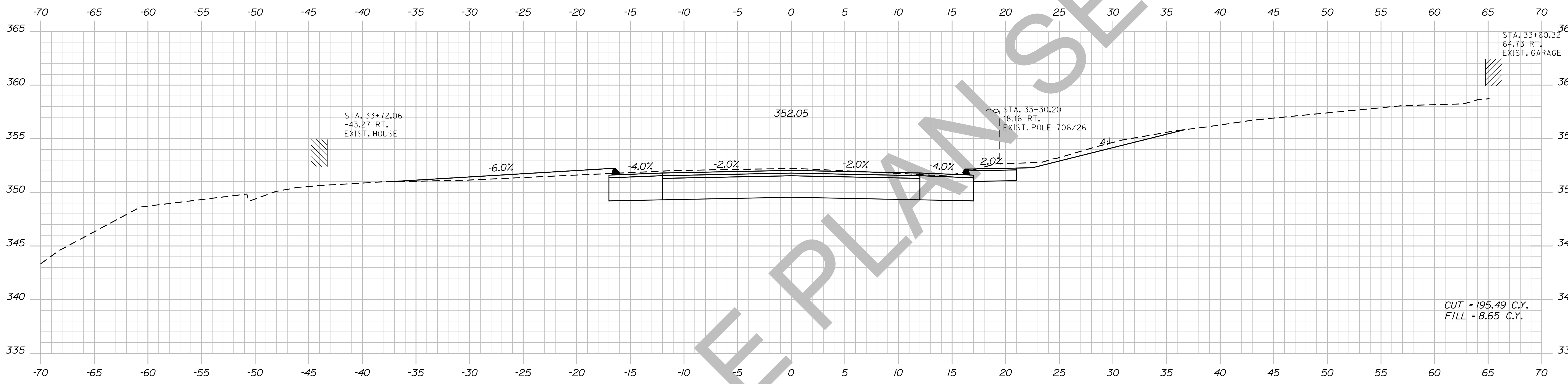

STATE OF MAINE  
DEPARTMENT OF TRANSPORTATION  
018246.00  
PIN 18246.00  
HIGHWAY PLANS

DESIGN-DETAILED	CHECKED-REVIEWED	DESIGN-DETAILED	REVISIONS 1	REVISIONS 2	REVISIONS 3	REVISIONS 4	FIELD CHANGES
ERNEST MARTIN	TRAVIS WEL						
PROJ. MANAGER	BY	DATE	SIGNATURE	P.E. NUMBER	DATE		

DEXTER  
ROUTE 7  
CROSS SECTIONS

SHEET NUMBER  
**57**  
OF 15

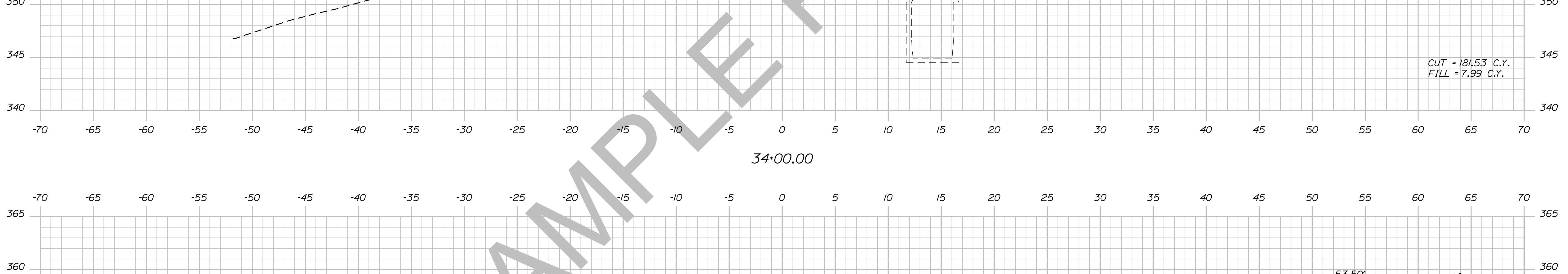
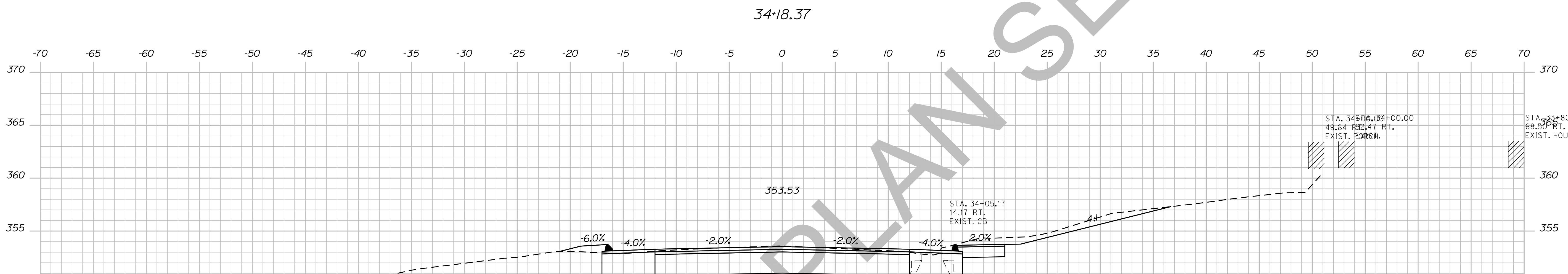
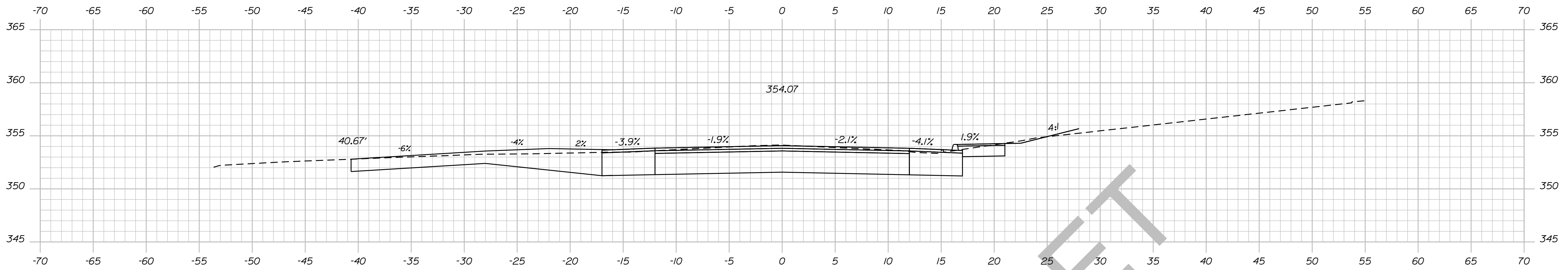

STATE OF MAINE  
DEPARTMENT OF TRANSPORTATION  
018246.00  
PIN 18246.00  
HIGHWAY PLANS

DESIGN/REVIEWED	DATE
PROJ. MANAGER ERNEST MARTIN	
CHECKED/REVIEWED TRAVIS WHEELER	
DESIGN/DET AILED	
DESIGN/DET AILED	
REVISIONS 1	
REVISIONS 2	
REVISIONS 3	
REVISIONS 4	
FIELD CHANGES	

DEXTER  
ROUTE 7  
CROSS SECTIONS

SHEET NUMBER  
**58**  
OF 15



Date: 5/19/2014

Username: Allee.Mousseau

Division: HIGHWAY

Filename: ... \059\_XSECT\_34+21\_026.dgn

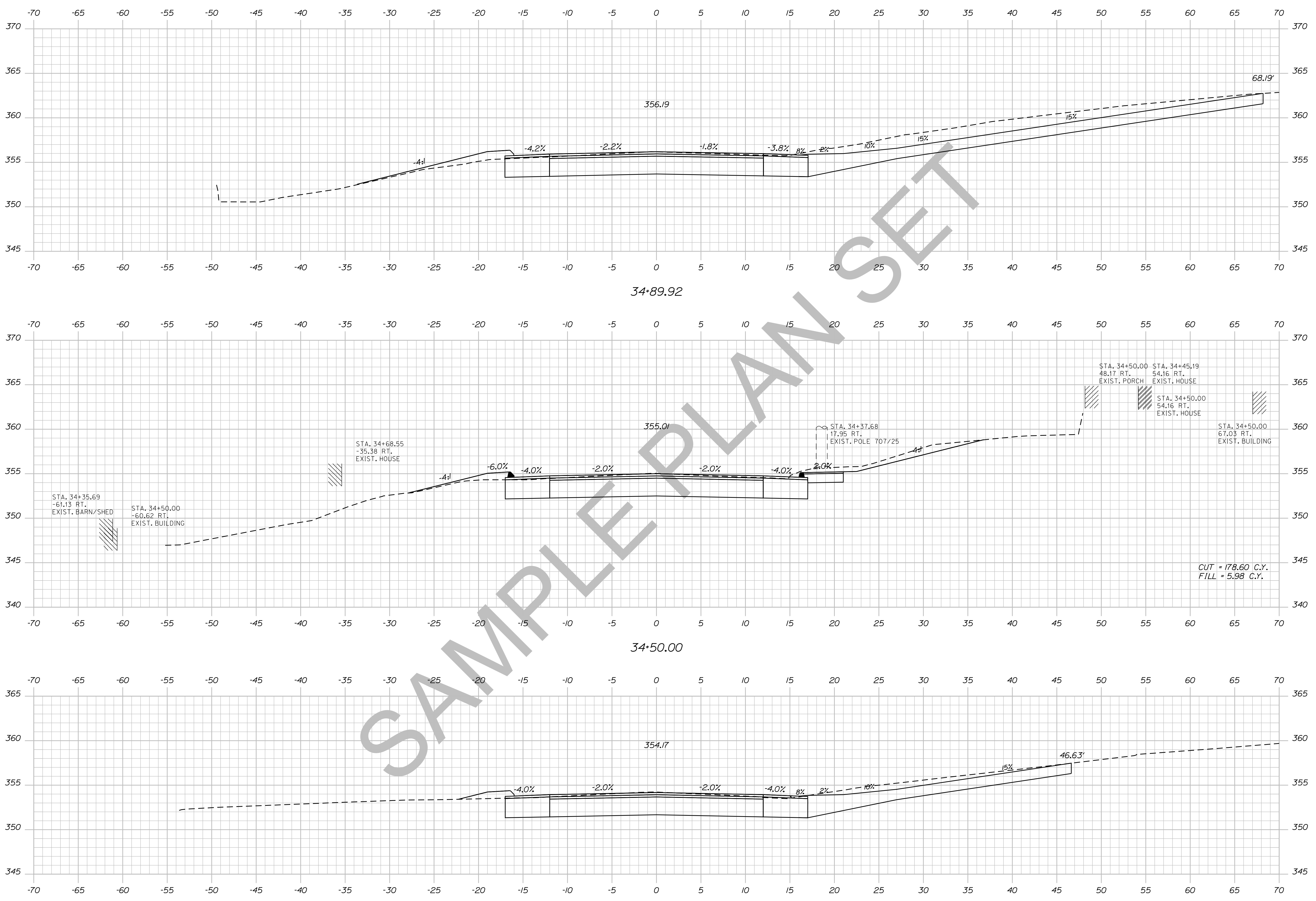

SAMPLE PLAN SET

STATE OF MAINE DEPARTMENT OF TRANSPORTATION			
PIN 18246.00		HIGHWAY PLANS	
018246.00			
SIGNATURE	P.E. NUMBER	DATE	
PROJ. MANAGER ERNEST MARTIN	BY TRAVIS WHEL	DATE	DATE
DESIGN/DETAILED	CHECKED/REVIEWED	DESIGN/DETAILED	DESIGN/DETAILED
REVISIONS 1	REVISIONS 2	REVISIONS 3	REVISIONS 4
FIELD CHANGES			
DEXTER ROUTE 7 CROSS SECTIONS			
SHEET NUMBER			
59			
OF 15			

Sta. 34+21.90 to Sta. 34+89.92

Date: 5/19/2014

Username: Alee.Mousseau

Division: HIGHWAY

Filename: ... \060\_XSECT\_35+00\_027.dgn

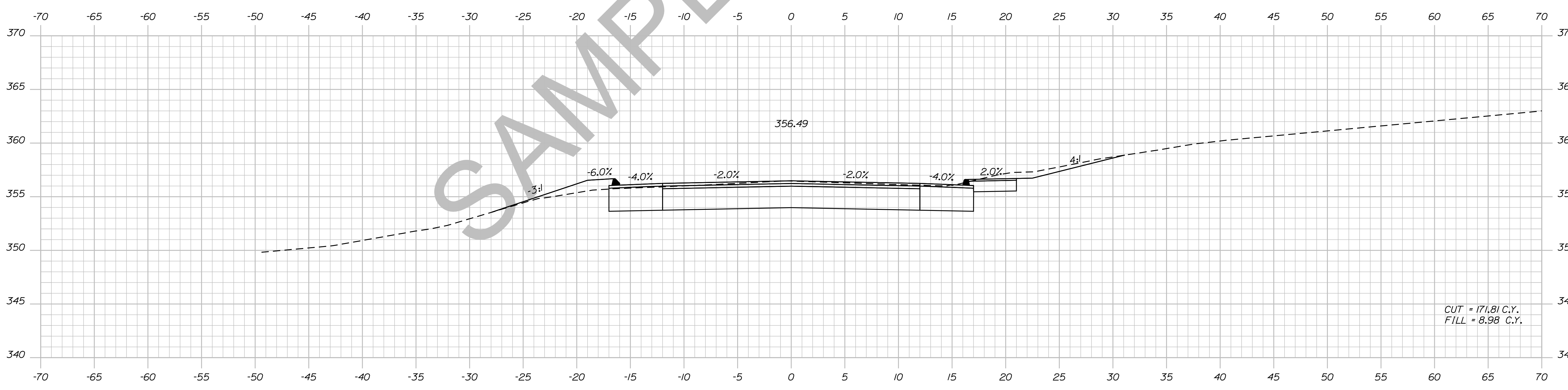
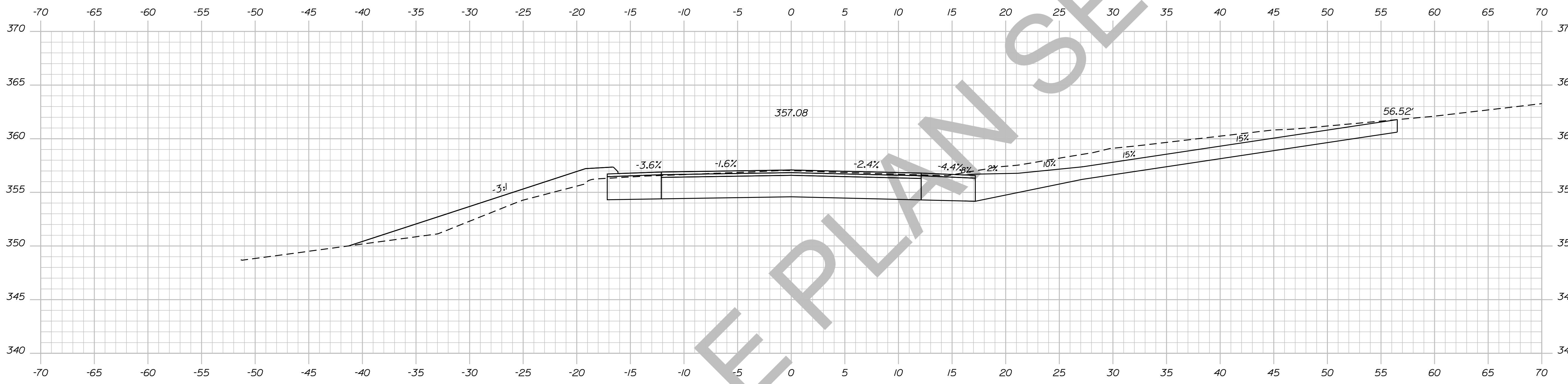

CUT = 171.81 C.Y.  
 FILL = 8.98 C.Y.

STATE OF MAINE  
 DEPARTMENT OF TRANSPORTATION  
 018246.00  
 PIN  
 18246.00  
 HIGHWAY PLANS

DESIGN-DETAILED	CHECKED-REVIEWED	DESIGN-DETAILED	DESIGN-DETAILED	REVISIONS 1	REVISIONS 2	REVISIONS 3	REVISIONS 4	FIELD CHANGES
PROJ. MANAGER ERNEST MARTIN	TRAVIS WEL							
DATE	BY	SIGNATURE		P.E. NUMBER		DATE		

DEXTER  
 ROUTE 7  
 CROSS SECTIONS

SHEET NUMBER  
 60  
 OF 15

Date: 5/19/2014

Username: Alee.Mousseau

Division: HIGHWAY

Filename: ... \061\_XSECT\_35+50\_028.dgn

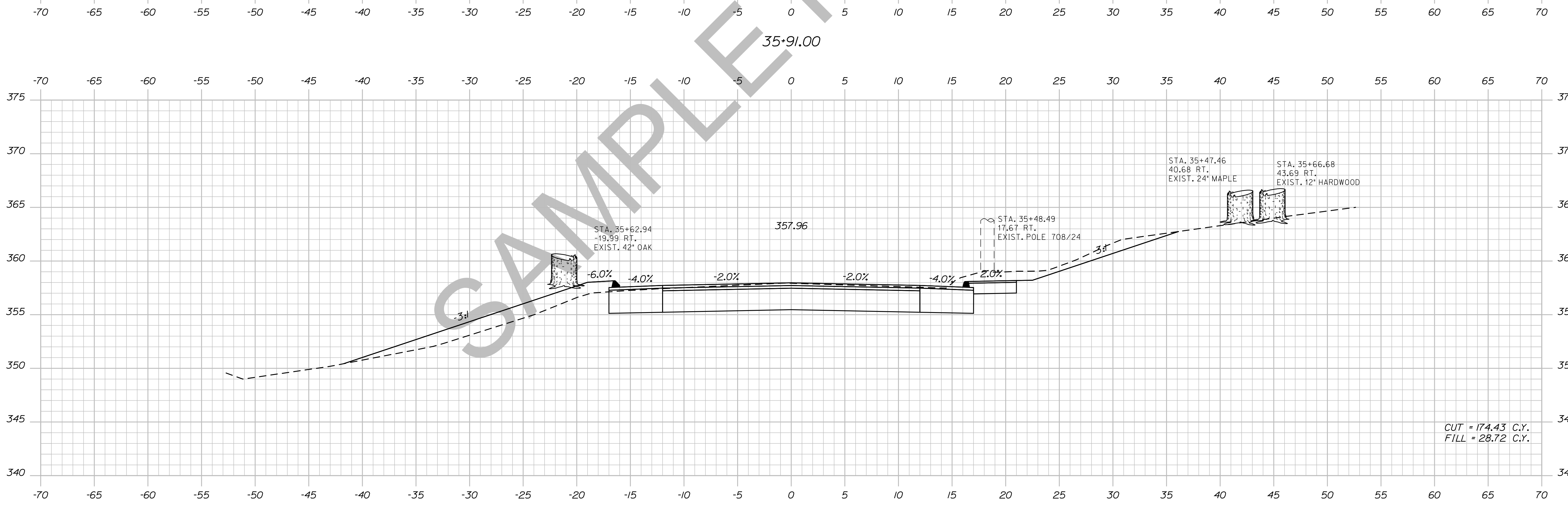
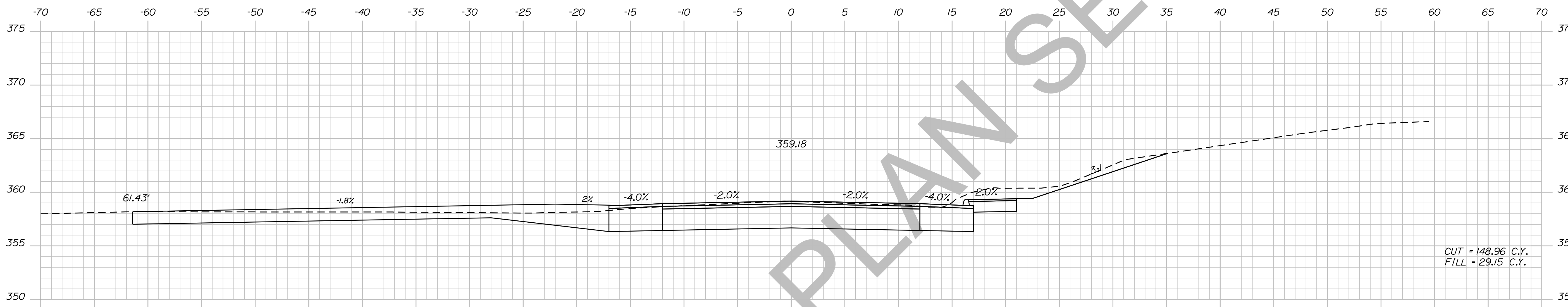

STATE OF MAINE  
DEPARTMENT OF TRANSPORTATION  
018246.00  
PIN 18246.00  
HIGHWAY PLANS

PROJ. MANAGER	ERNEST MARTIN	BY	DATE
CHECKED-REVIEWED	TRAVIS WOLFE		
DESIGN DETAILED		SIGNATURE	
DESIGN DETAILED		P.E. NUMBER	
REVISIONS 1		DATE	
REVISIONS 2			
REVISIONS 3			
REVISIONS 4			
FIELD CHANGES			

DEXTER  
ROUTE 7  
CROSS SECTIONS

SHEET NUMBER  
**61**  
OF 15

Date: 5/19/2014

Username: Alee.Mousseau

Division: HIGHWAY

Filename: ... \062\_XSECT\_36+00\_029.dgn

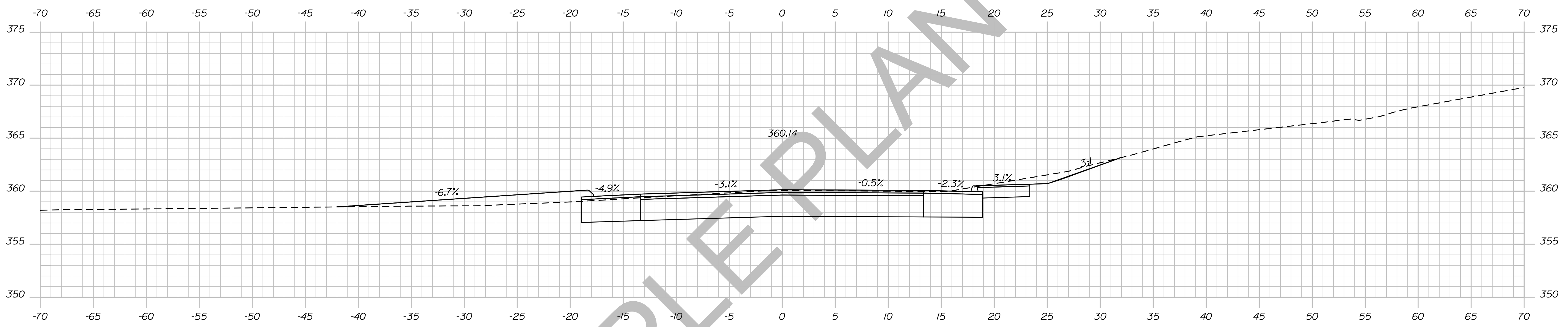

36+23.51

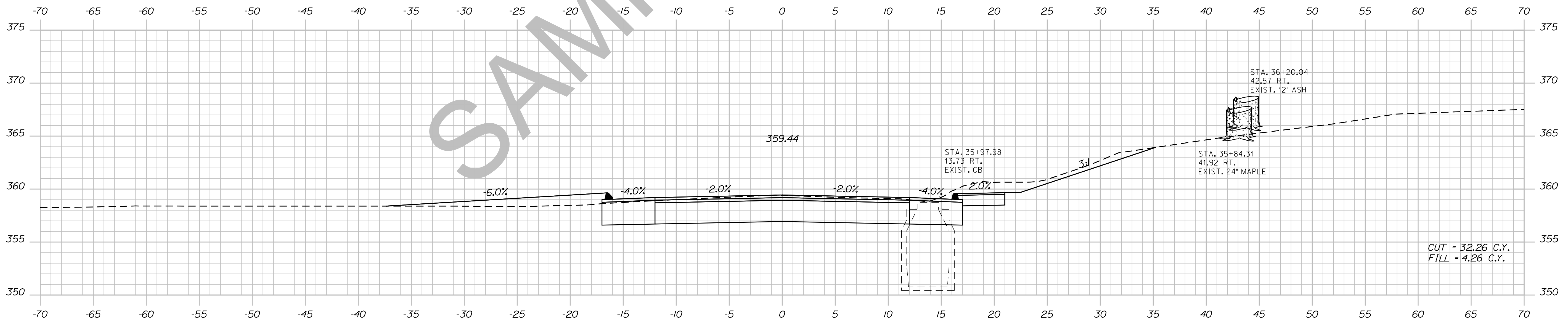

36+00.00

CUT = 32.26 C.Y.  
FILL = 4.26 C.Y.

STATE OF MAINE  
DEPARTMENT OF TRANSPORTATION  
018246-00  
PIN  
18246.00  
HIGHWAY PLANS

DESIGN-DETAILED	CHECKED-REVIEWED	DESIGN-DETAILED	DESIGN-DETAILED	REVISIONS 1	REVISIONS 2	REVISIONS 3	REVISIONS 4	FIELD CHANGES
TRAVIS WOLFE								
PROJ. MANAGER	ERNEST MARTIN	BY	DATE	SIGNATURE	P.E. NUMBER	DATE		

DEXTER  
ROUTE 7  
CROSS SECTIONS

SHEET NUMBER  
**62**  
OF 15



Date: 5/19/2014

Username: Alee.Mousseau

Division: HIGHWAY

Filename: ... \063\_XSECT\_36+50\_030.dgn

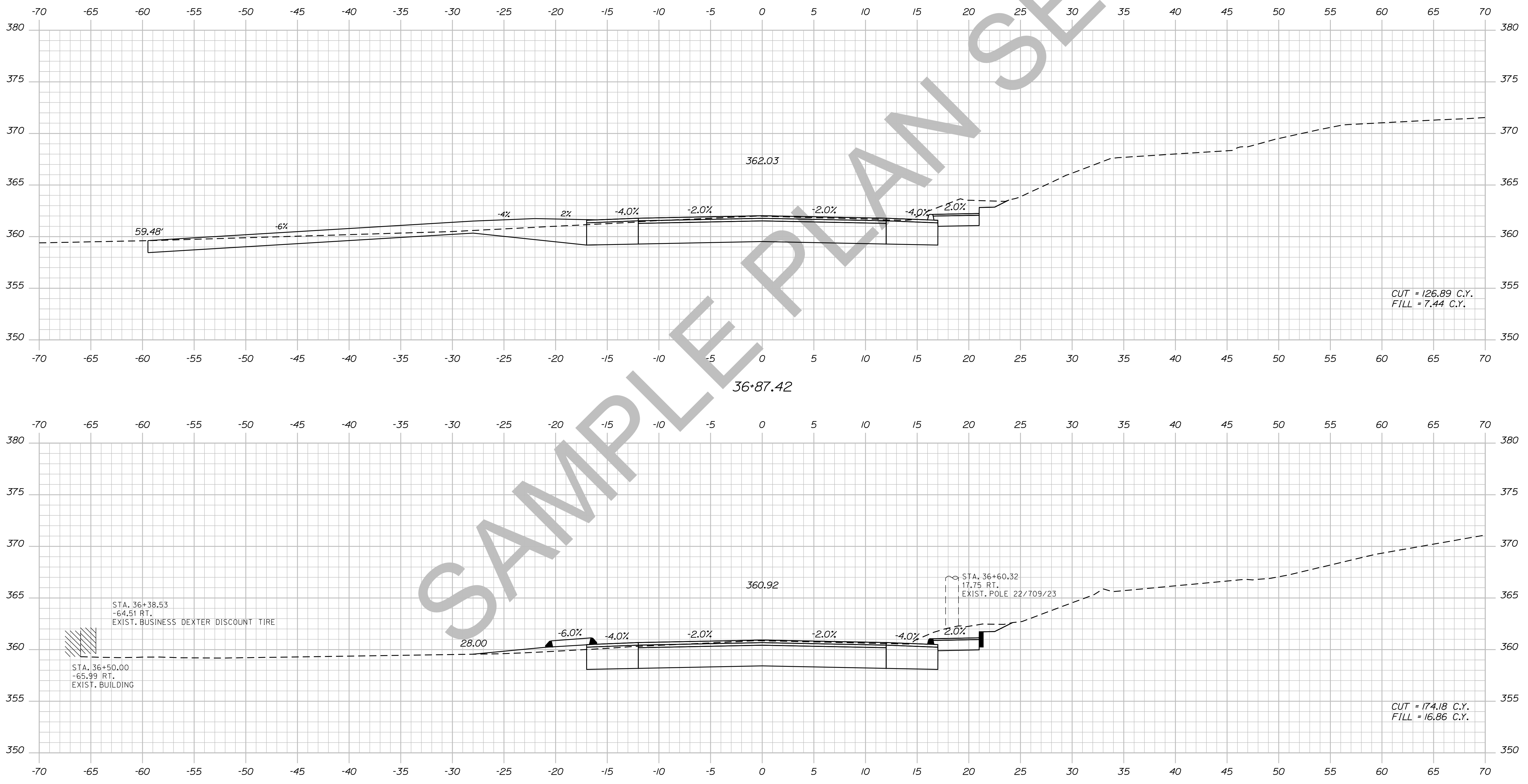

STATE OF MAINE  
 DEPARTMENT OF TRANSPORTATION  
 018246.00  
 PIN 18246.00  
 HIGHWAY PLANS

DESIGN-DETAILED	CHECKED-REVIEWED	DESIGN-DETAILED	REVISIONS 1	REVISIONS 2	REVISIONS 3	REVISIONS 4	FIELD CHANGES
TRAVIS WEL							
PROJ. MANAGER	ERNEST MARTIN	BY	DATE	SIGNATURE	P.E. NUMBER	DATE	

DEXTER  
 ROUTE 7  
 CROSS SECTIONS

SHEET NUMBER  
**63**  
 OF 15

Date: 5/19/2014

Username: Allee.Mousseau

Division: HIGHWAY

Filename: ... \064\_XSECT\_37+00\_031.dgn

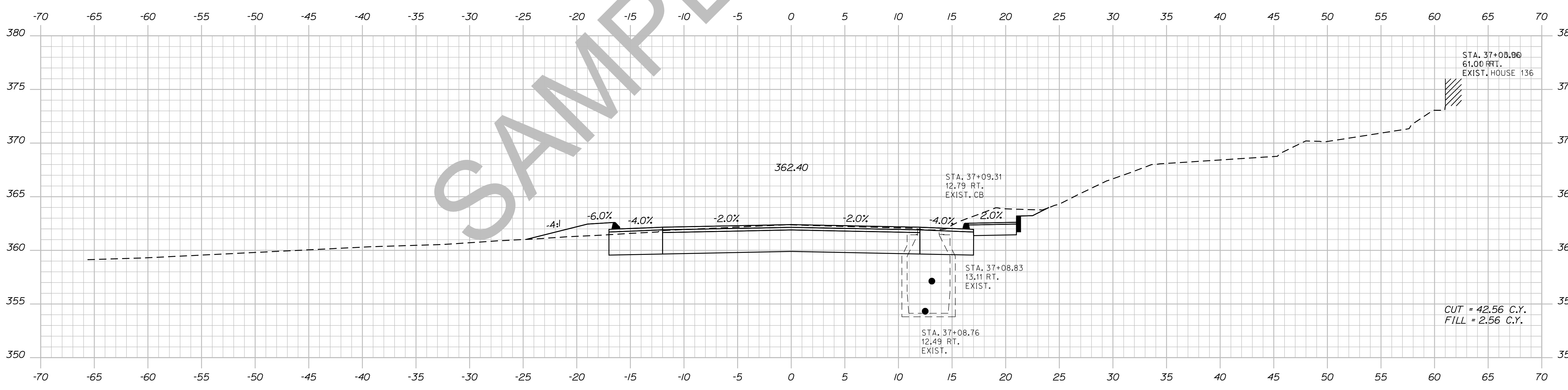
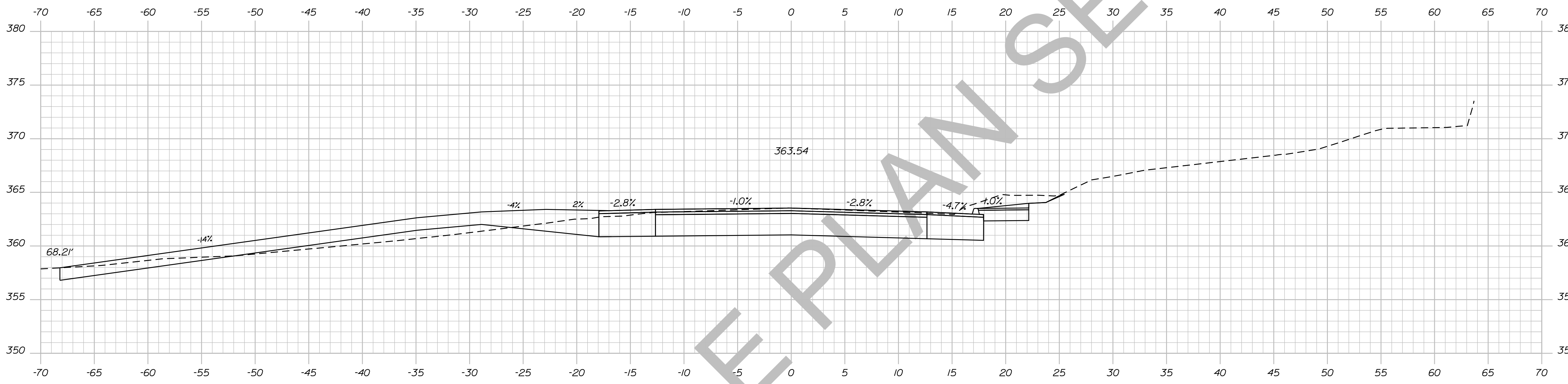

SAMPLE PLAN SET

STATE OF MAINE  
DEPARTMENT OF TRANSPORTATION  
018246.00  
PIN  
18246.00  
HIGHWAY PLANS

DESIGN/DETAILS	DATE	SIGNATURE
DESIGN-REVIEWED		
DESIGN-DETAILED		
REVISIONS 1		P.E. NUMBER
REVISIONS 2		DATE
REVISIONS 3		
REVISIONS 4		
FIELD CHANGES		

DEXTER  
ROUTE 7  
CROSS SECTIONS

SHEET NUMBER  
**64**  
OF 15

Date: 5/19/2014

Username: Allee.Mousseau

Division: HIGHWAY

Filename: ... \065\_XSECT\_37+50\_032.dgn

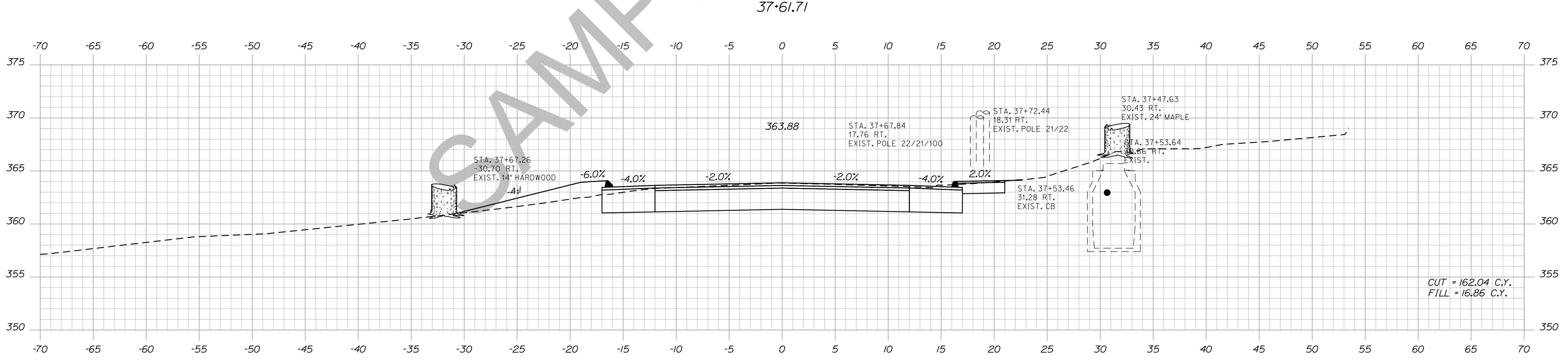
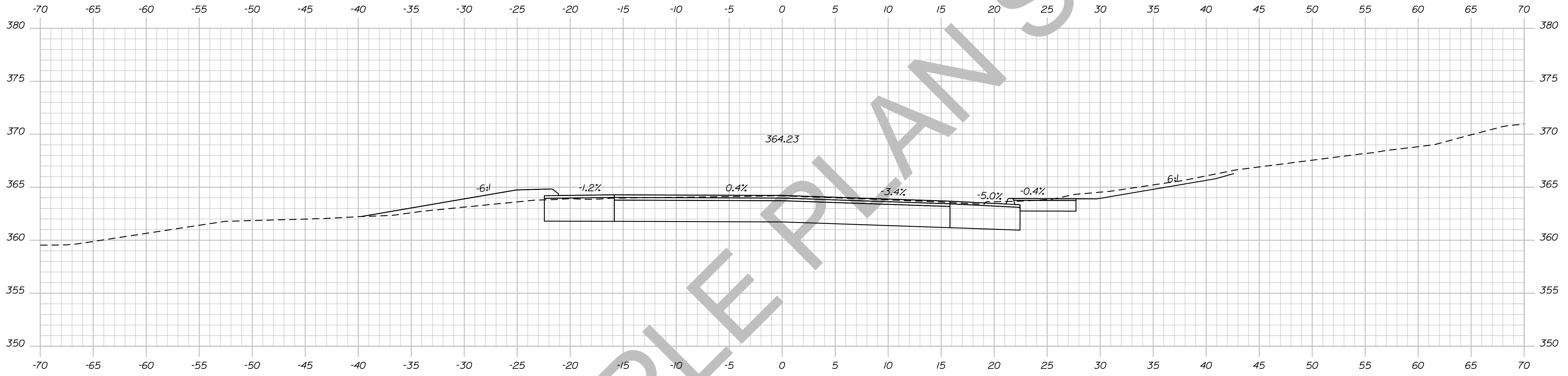

STATE OF MAINE  
DEPARTMENT OF TRANSPORTATION  
018246.00  
PIN  
18246.00  
HIGHWAY PLANS

DATE	SIGNATURE	P.E. NUMBER	DATE

DEXTER  
ROUTE 7  
CROSS SECTIONS

SHEET NUMBER  
**65**  
OF 15

Date: 5/19/2014

Username: Alee.Mousseau

Division: HIGHWAY

Filename: ... \066\_XSECT\_38+00\_033.dgn

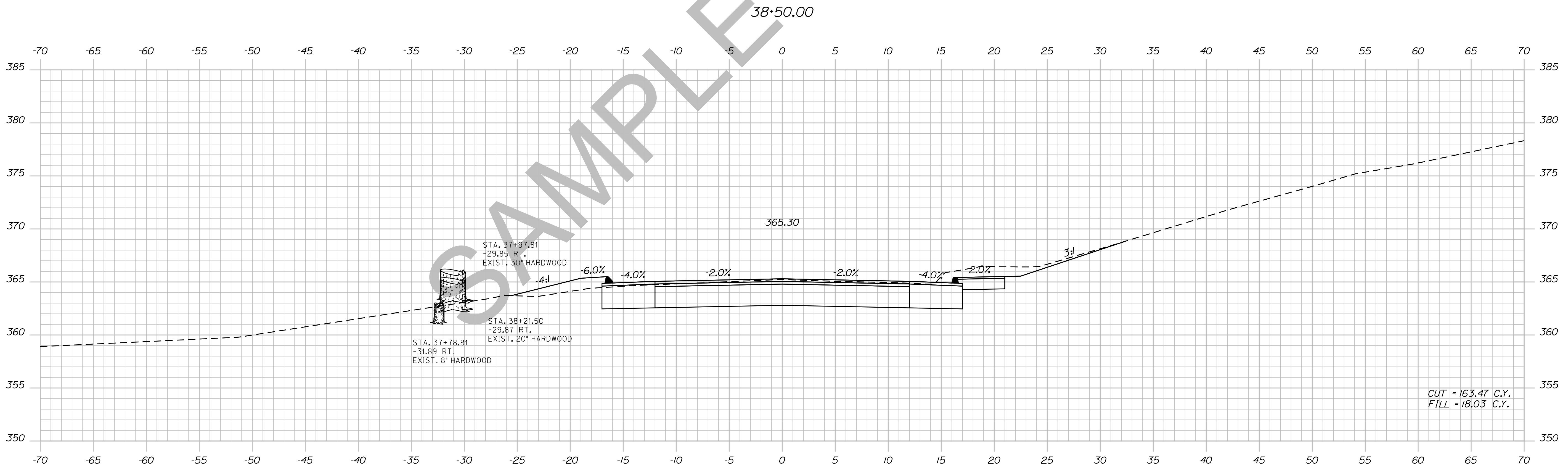
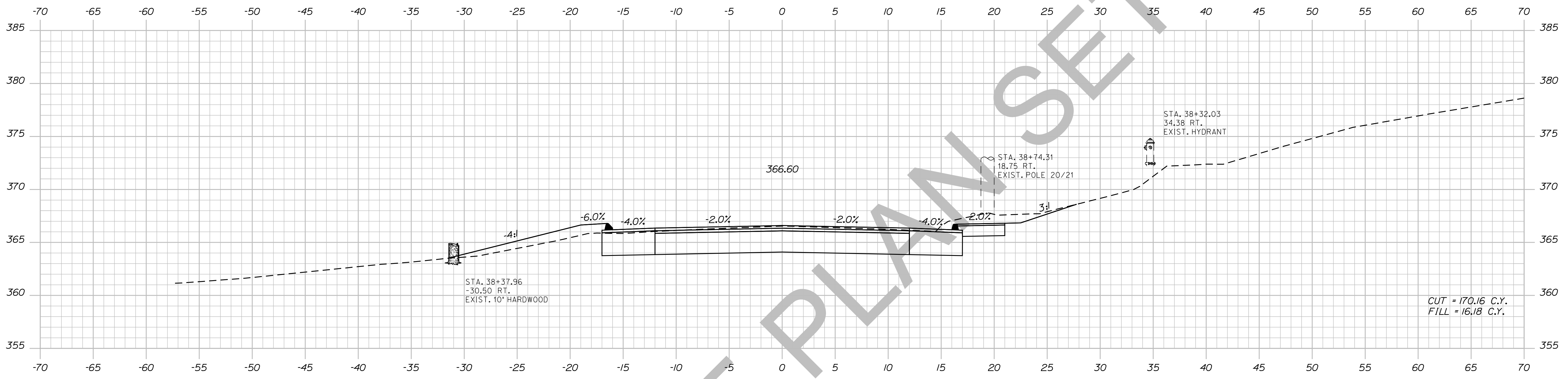

STATE OF MAINE  
DEPARTMENT OF TRANSPORTATION  
018246.00  
PIN  
18246.00  
HIGHWAY PLANS

PROJ. MANAGER	BY	DATE	SIGNATURE	P.E. NUMBER	DATE
ERNEST MARTIN	TRAVIS WEL				
DESIGN/DETAILED	CHECKED/REVIEWED	DESIGN/DETAILED	DESIGN/DETAILED	REVISIONS 1	REVISIONS 2
				REVISIONS 3	REVISIONS 4
				FIELD CHANGES	

DEXTER  
ROUTE 7  
CROSS SECTIONS

SHEET NUMBER  
**66**  
OF 15



Date: 5/19/2014

Username: Allee.Mousseau

Division: HIGHWAY

Filename: ... \067\_XSECT\_38+87\_034.dgn

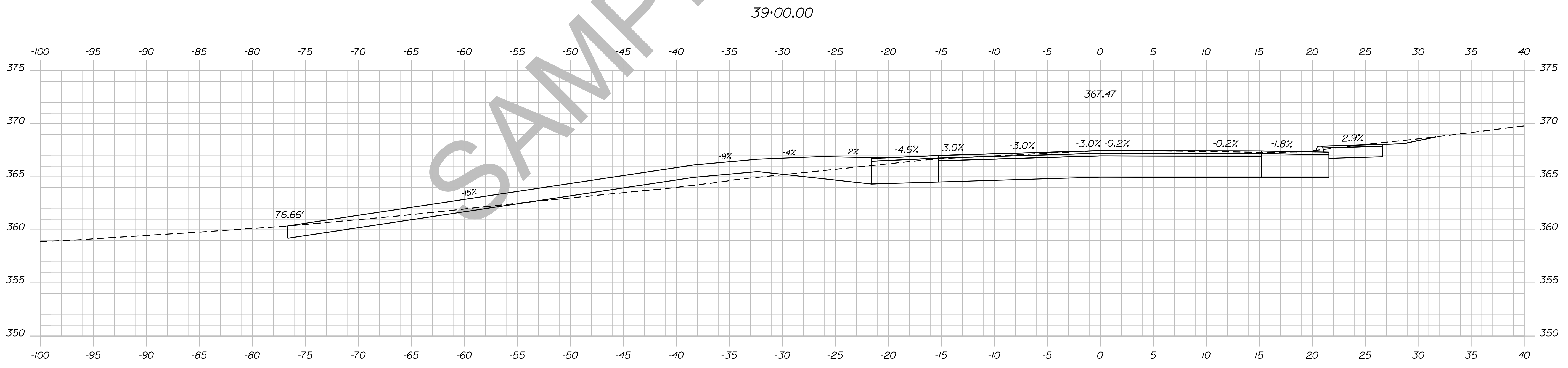
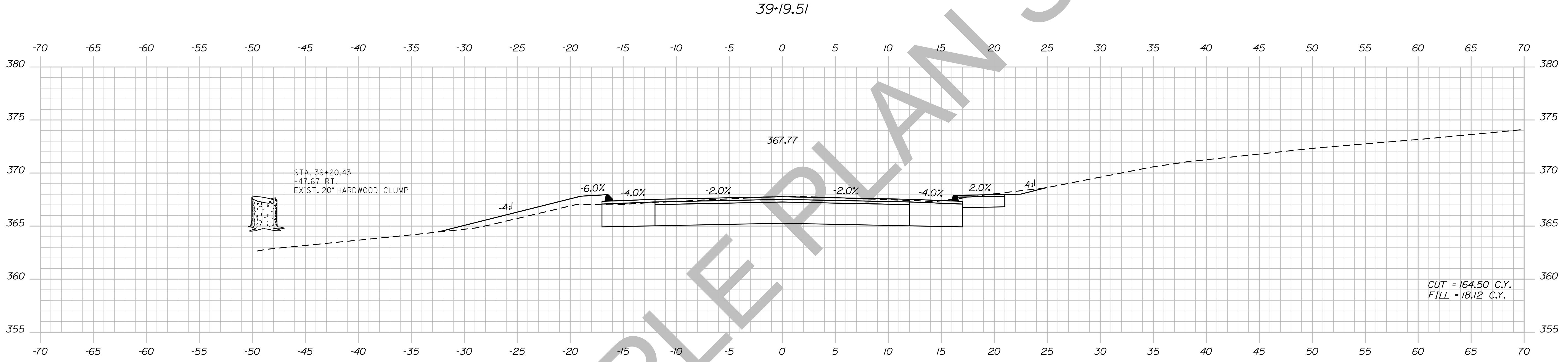
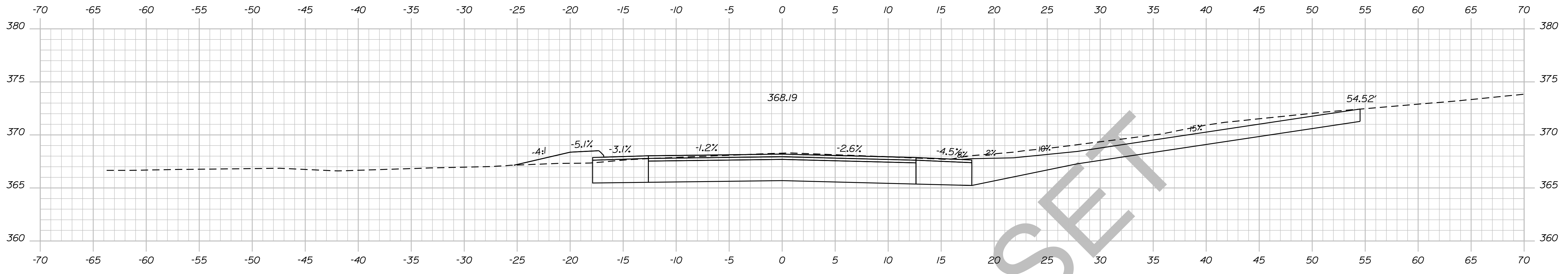

STATE OF MAINE  
DEPARTMENT OF TRANSPORTATION  
018246.00  
PIN  
18246.00  
HIGHWAY PLANS

PROJ. MANAGER	BY	DATE	SIGNATURE	P.E. NUMBER	DATE
ERNEST MARTIN	TRAVIS WHEEL				
DESIGN/REVIEWED					
DESIGN/REVIEWED					
REVISIONS 1					
REVISIONS 2					
REVISIONS 3					
REVISIONS 4					
FIELD CHANGES					

DEXTER  
ROUTE 7  
CROSS SECTIONS

SHEET NUMBER  
**67**  
OF 15

Date: 5/19/2014

Username: Ailee.Mousseau

Division: HIGHWAY

Filename: ... \068\_XSECT\_39+45\_035.dgn

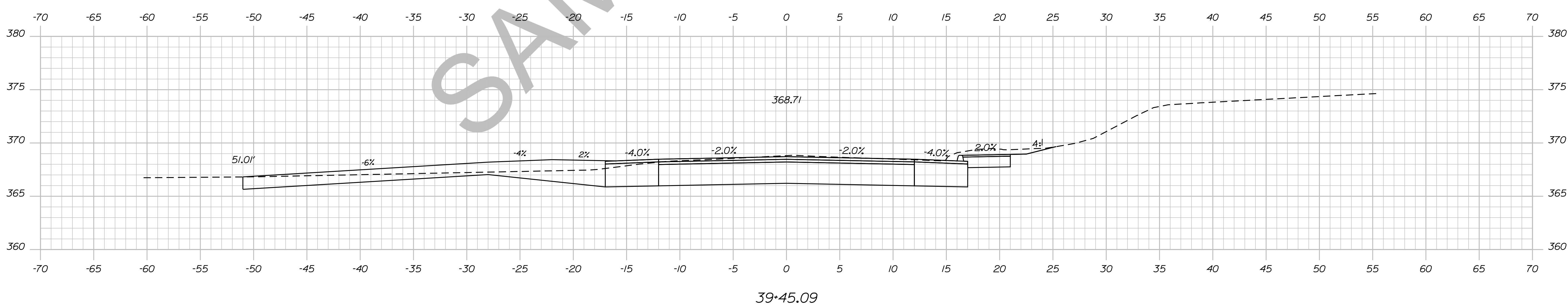
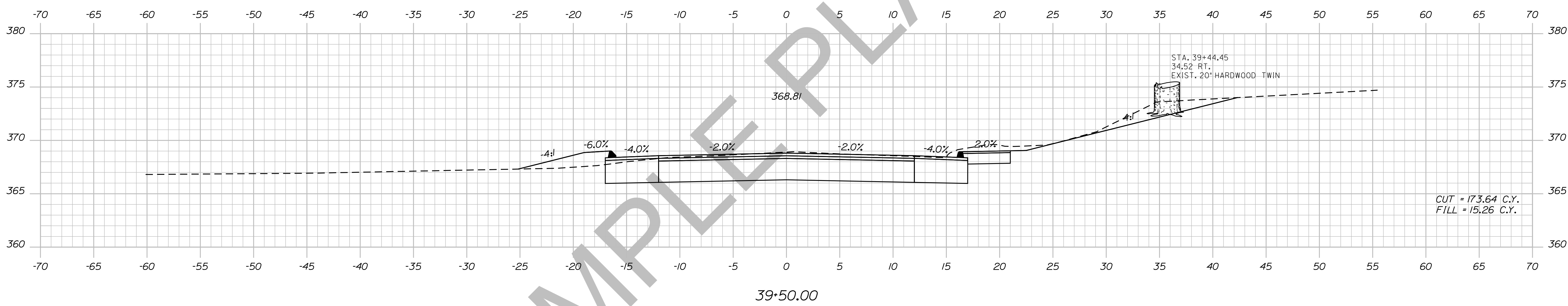
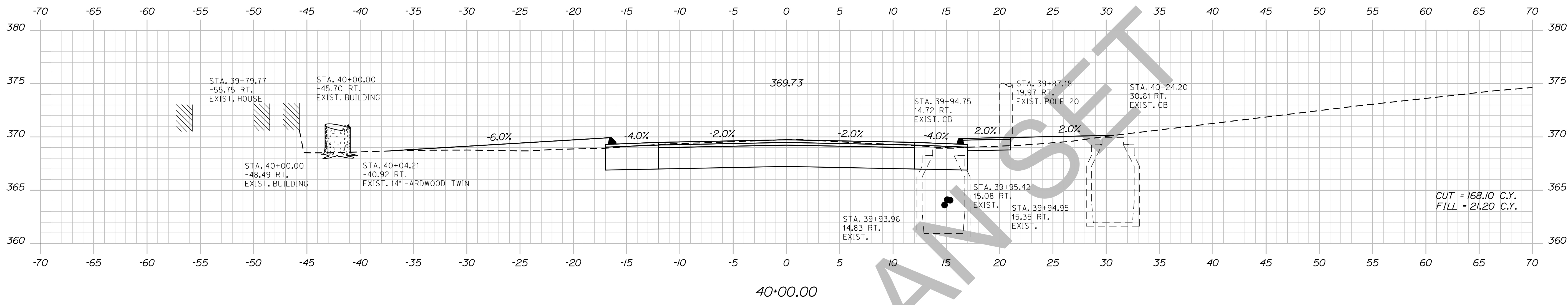

STATE OF MAINE DEPARTMENT OF TRANSPORTATION		018246.00	
		PIN 18246.00	
		HIGHWAY PLANS	
PROJ. MANAGER	ERNEST MARTIN	BY	DATE
DESIGN DETAILED	TRAVIS WOLFE		
CHECKED/REVIEWED			
DESIGN DETAILED			
REVISIONS 1		SIGNATURE	P.E. NUMBER
REVISIONS 2			DATE
REVISIONS 3			
REVISIONS 4			
FIELD CHANGES			
DEXTER ROUTE 7 CROSS SECTIONS			
SHEET NUMBER			
68			
OF 15			

Date: 5/19/2014

Username: Alee.Mousseau

Division: HIGHWAY

Filename: ... \069\_XSECT\_40+30\_036.dgn

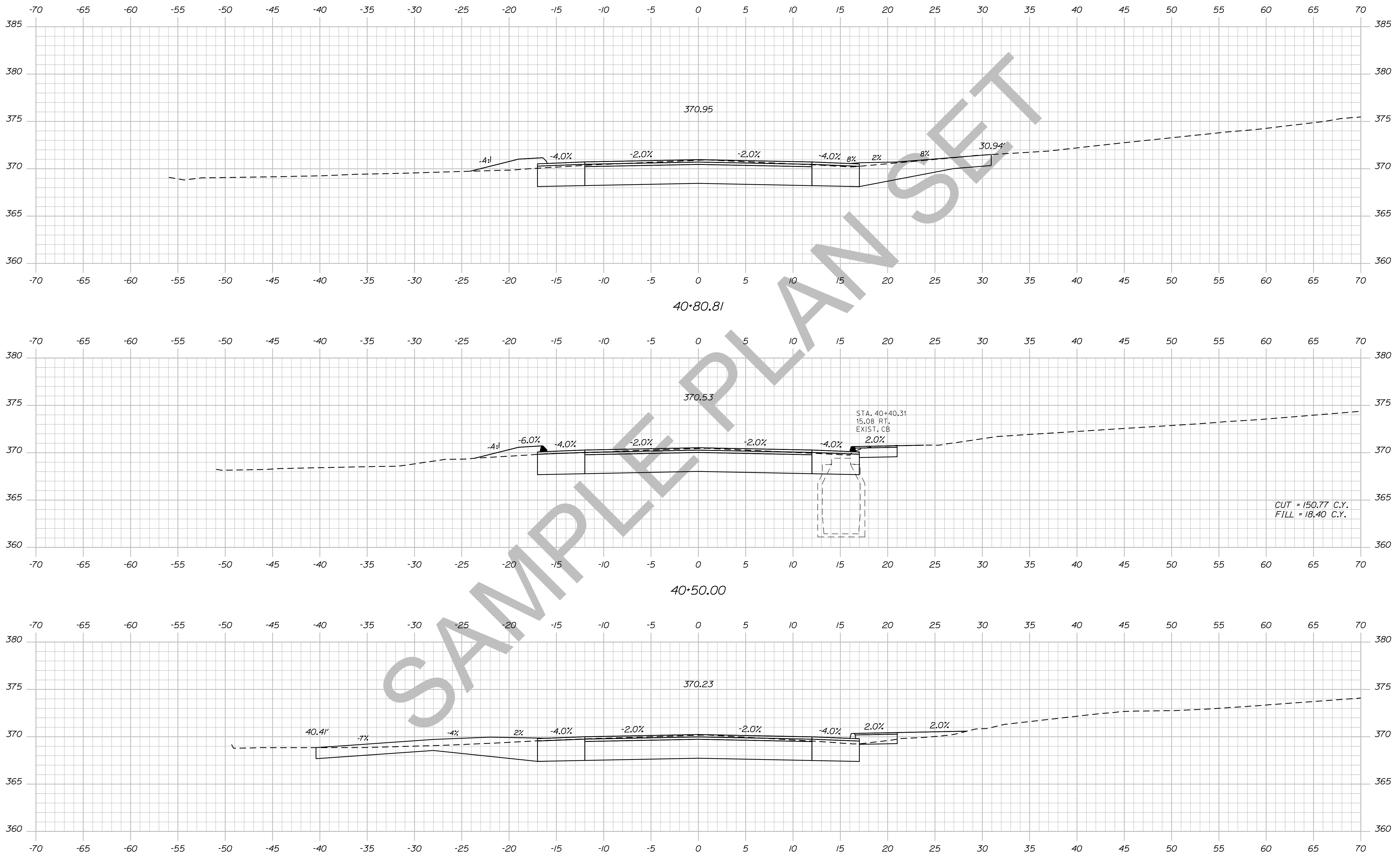

STATE OF MAINE  
DEPARTMENT OF TRANSPORTATION  
018246.00  
PIN 18246.00  
HIGHWAY PLANS

DESIGN-DETAILED	TRAVIS WOLFE
CHECKED-REVIEWED	
DESIGNS-DETAILED	
REVISIONS 1	
REVISIONS 2	
REVISIONS 3	
REVISIONS 4	
FIELD CHANGES	

PROJ. MANAGER	ERNEST MARTIN
BY	TRAVIS WOLFE
DATE	
SIGNATURE	
P.E. NUMBER	
DATE	

DEXTER  
ROUTE 7  
CROSS SECTIONS

SHEET NUMBER  
**69**  
OF 15

Date: 5/19/2014

Username: Alee.Mousseau

Division: HIGHWAY

Filename: ... \070\_XSECT\_40+86\_037.dgn

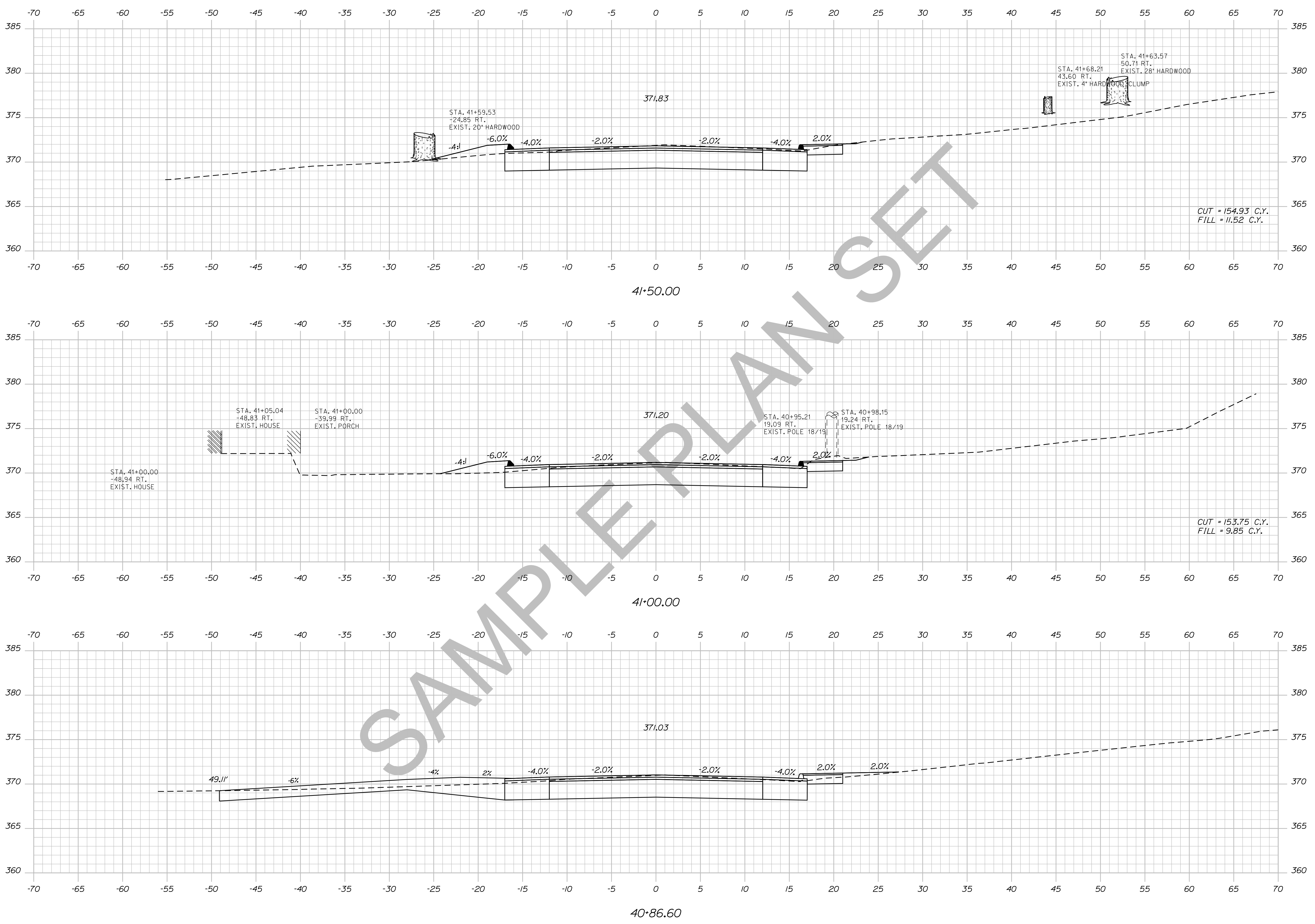

STATE OF MAINE DEPARTMENT OF TRANSPORTATION		018246.00	
		PIN 18246.00	
		HIGHWAY PLANS	
PROJ. MANAGER	ERNEST MARTIN	BY	DATE
DESIGN-DETAILED	TRAVIS WHEEL		
CHECKED-REVIEWED		SIGNATURE	
DESIGN-DETAILED		P.E. NUMBER	
DESIGN-DETAILED		DATE	
REVISIONS 1			
REVISIONS 2			
REVISIONS 3			
REVISIONS 4			
FIELD CHANGES			
DEXTER ROUTE 70		CROSS SECTIONS	
SHEET NUMBER		70	
		OF 15	



Date: 5/19/2014

Username: Alee.Mousseau

Division: HIGHWAY

Filename: ... \071\_XSECT\_41+53\_038.dgn

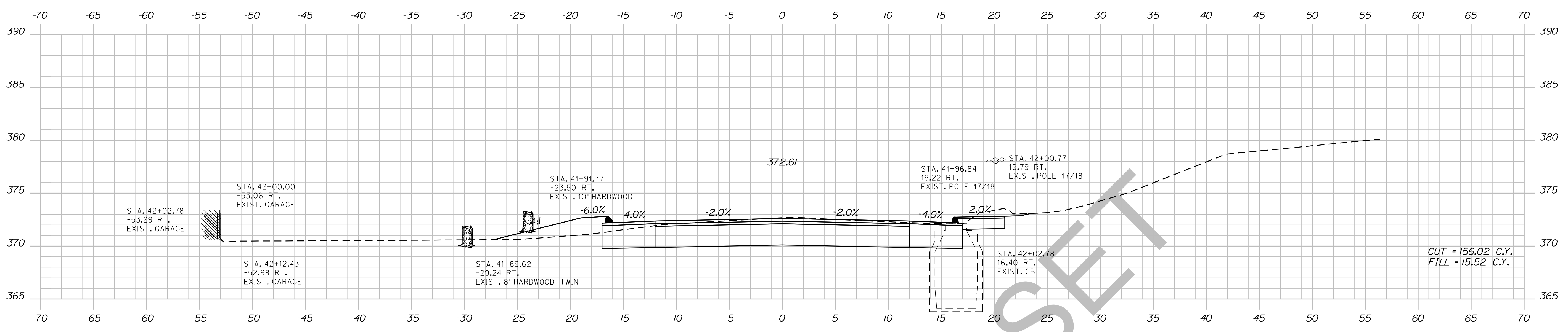

42+00.00

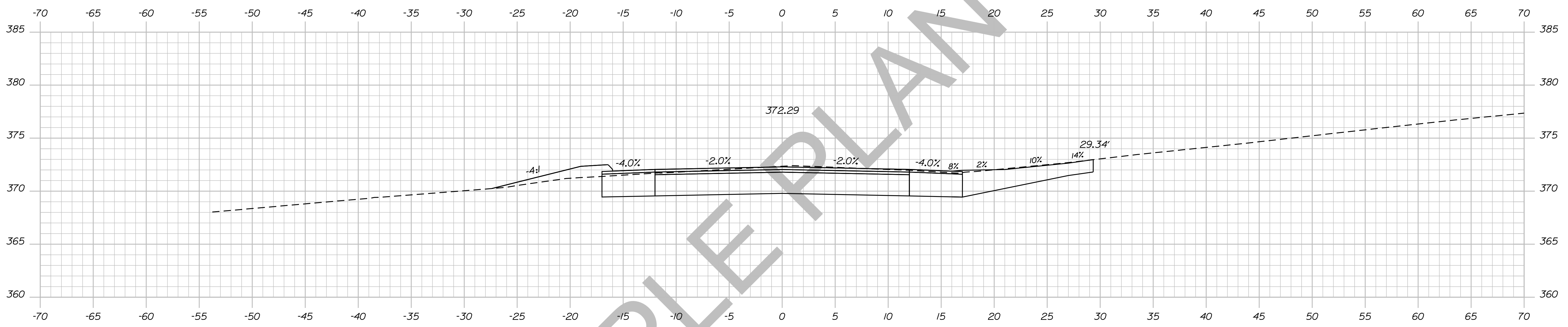

41+80.99

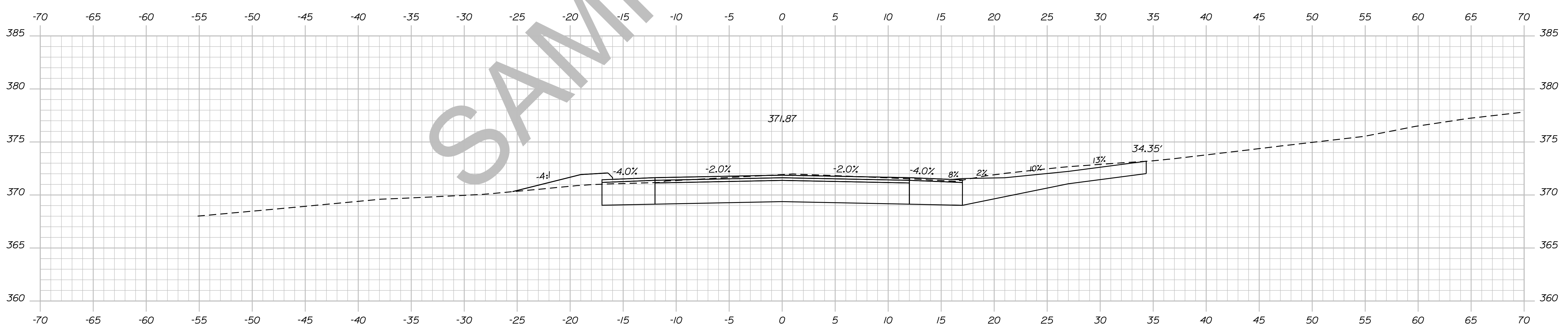

41+53.04

STATE OF MAINE DEPARTMENT OF TRANSPORTATION		018246-00	
		PIN 18246.00	
		HIGHWAY PLANS	
	SIGNATURE	P.E. NUMBER	DATE
PROJ. MANAGER ERNEST MARTIN	BY TRAVIS WHEEL		
DESIGN-DETAILED	CHECKED-REVIEWED	DESIGN-DETAILED	DESIGN-DETAILED
REVISIONS 1	REVISIONS 2	REVISIONS 3	REVISIONS 4
FIELD CHANGES			
DEXTER ROUTE 7		CROSS SECTIONS	
SHEET NUMBER			
71			
OF 15			

Date: 5/19/2014

Username: Alee.Mousseau

Division: HIGHWAY

Filename: ... \072\_XSECT\_42-08\_039.dgn

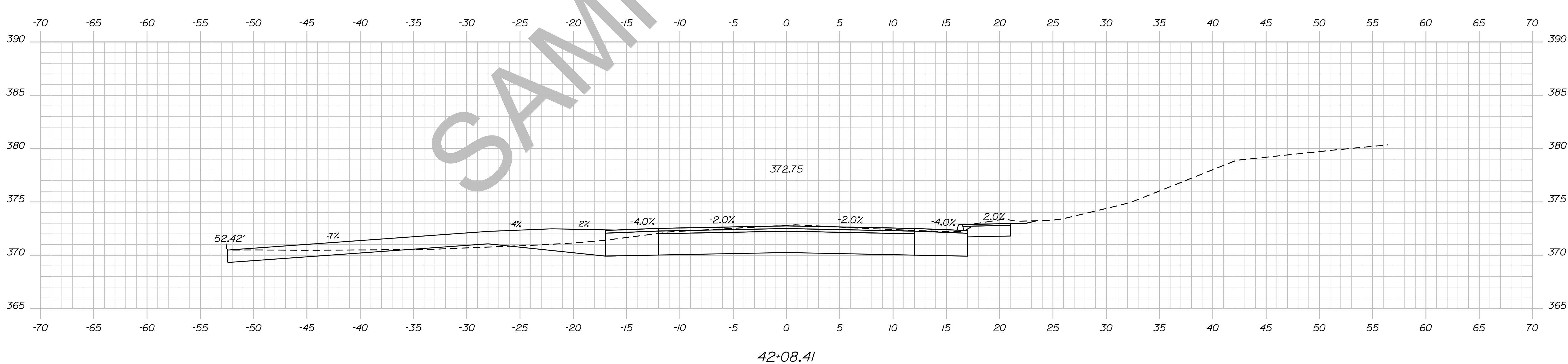
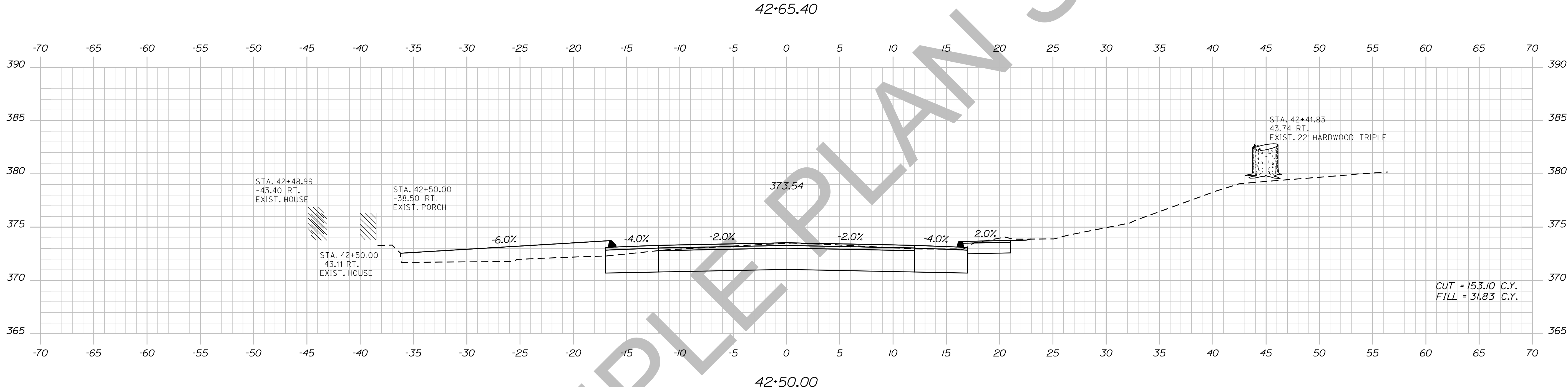
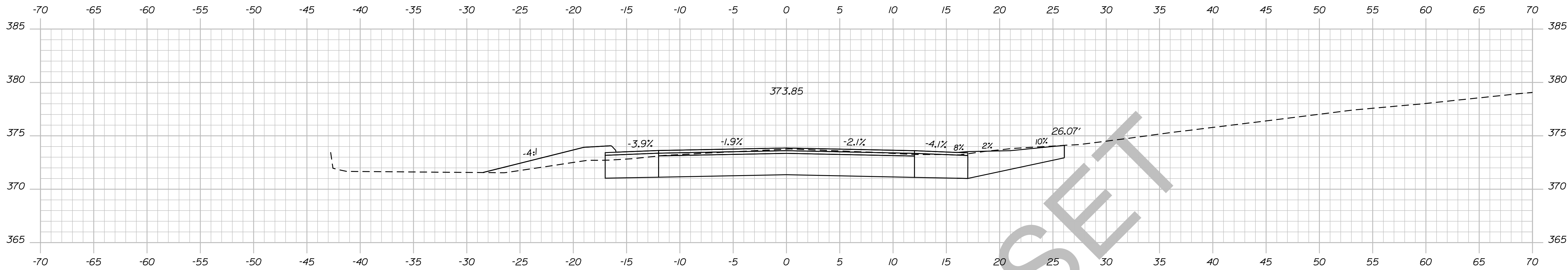

STATE OF MAINE DEPARTMENT OF TRANSPORTATION		018246-00		PIN 18246.00		HIGHWAY PLANS	
SIGNATURE		P.E. NUMBER		DATE		FIELD CHANGES	
PROJ. MANAGER	ERNEST MARTIN	BY	TRAVIS WHEELER	DESIGN-DETAILED		REVISIONS 1	
CHECKED-REVIEWED				DESIGN-DETAILED		REVISIONS 2	
				DESIGN-DETAILED		REVISIONS 3	
						REVISIONS 4	

**DEXTER ROUTE 7**

**CROSS SECTIONS**

SHEET NUMBER  
**72**  
OF 15

Date: 5/19/2014

Username: Alee.Mousseau

Division: HIGHWAY

Filename: ... \073\_XSECT\_42+88\_040.dgn

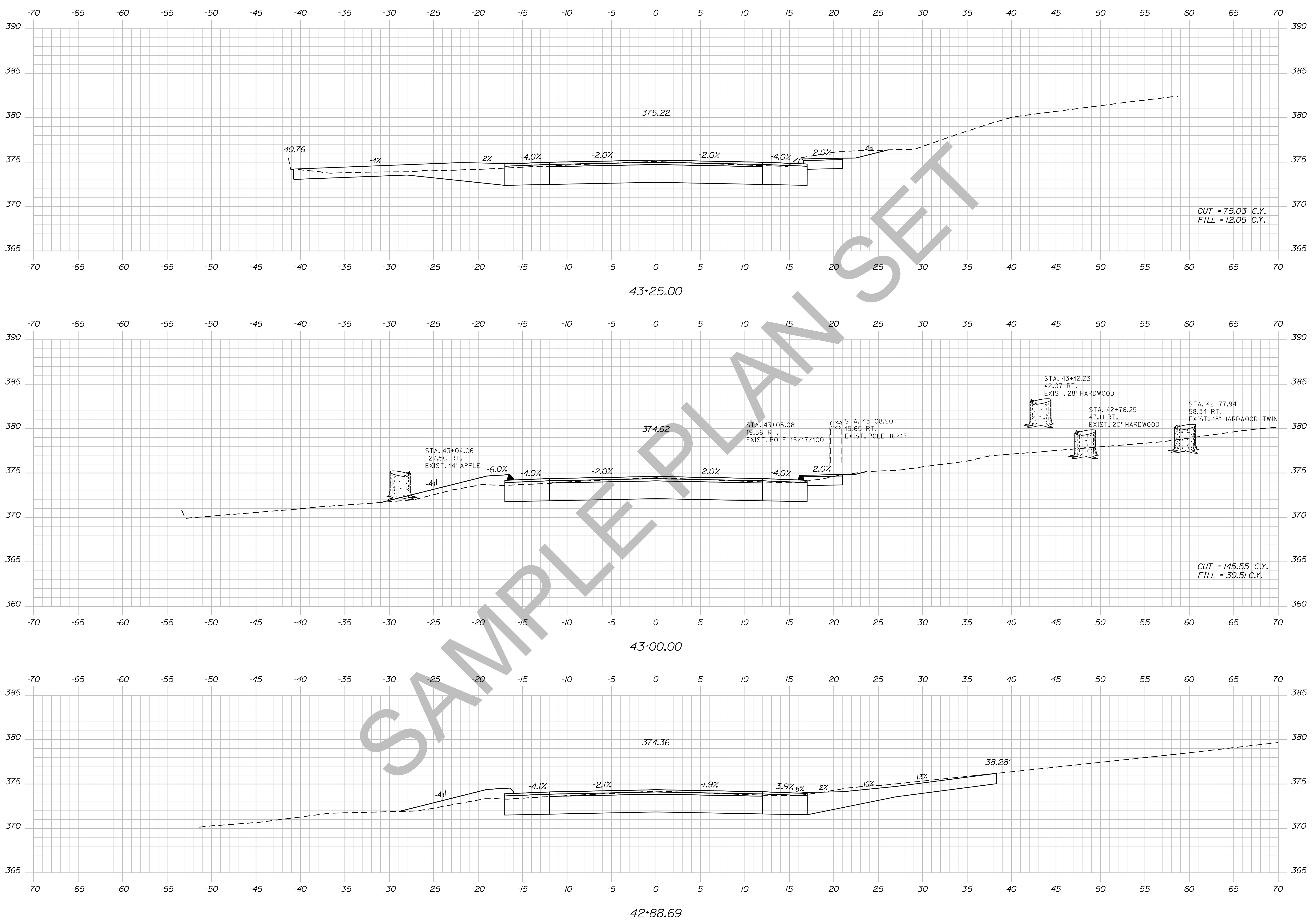

STATE OF MAINE DEPARTMENT OF TRANSPORTATION		018246.00	
		PIN 18246.00	
		HIGHWAY PLANS	
SIGNATURE	P.E. NUMBER	DATE	
PROJ. MANAGER ERNEST MARTIN	BY TRAVIS WOLFE		
DESIGN-DETAILED	CHECKED-REVIEWED	DESIGN-DETAILED	REVISIONS 1
DESIGN-DETAILED	DESIGN-DETAILED	REVISIONS 2	REVISIONS 3
REVISIONS 1	REVISIONS 2	REVISIONS 3	REVISIONS 4
REVISIONS 2	REVISIONS 3	REVISIONS 4	FIELD CHANGES
DEXTER ROUTE 7		CROSS SECTIONS	
SHEET NUMBER			
73			
OF 15			

Date: 5/19/2014

Username: Alee.Mousseau

Division: HIGHWAY

Filename: ... \074\_XSECT\_43+50\_041.dgn

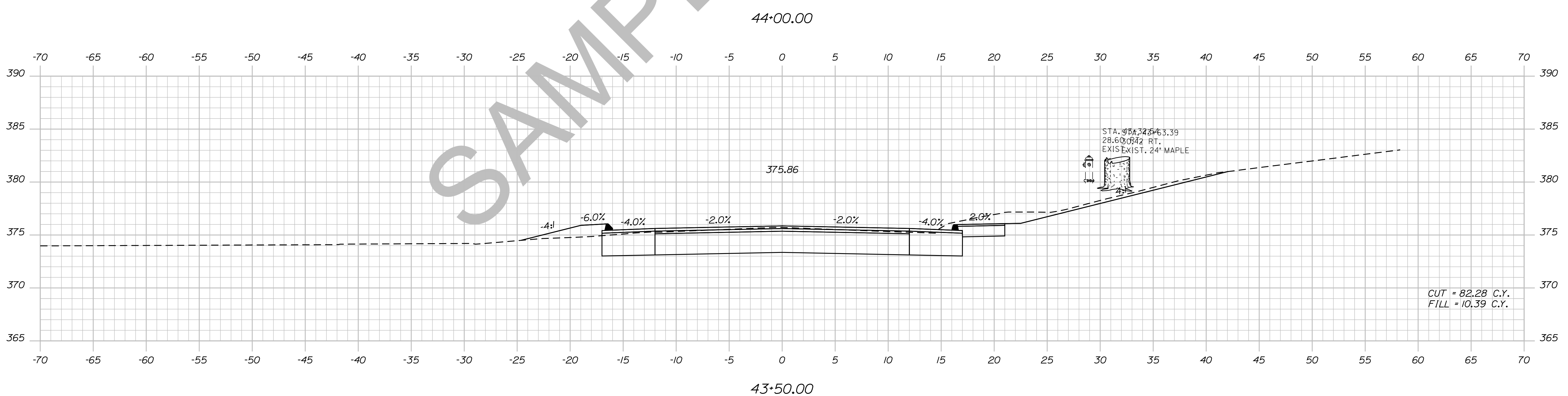
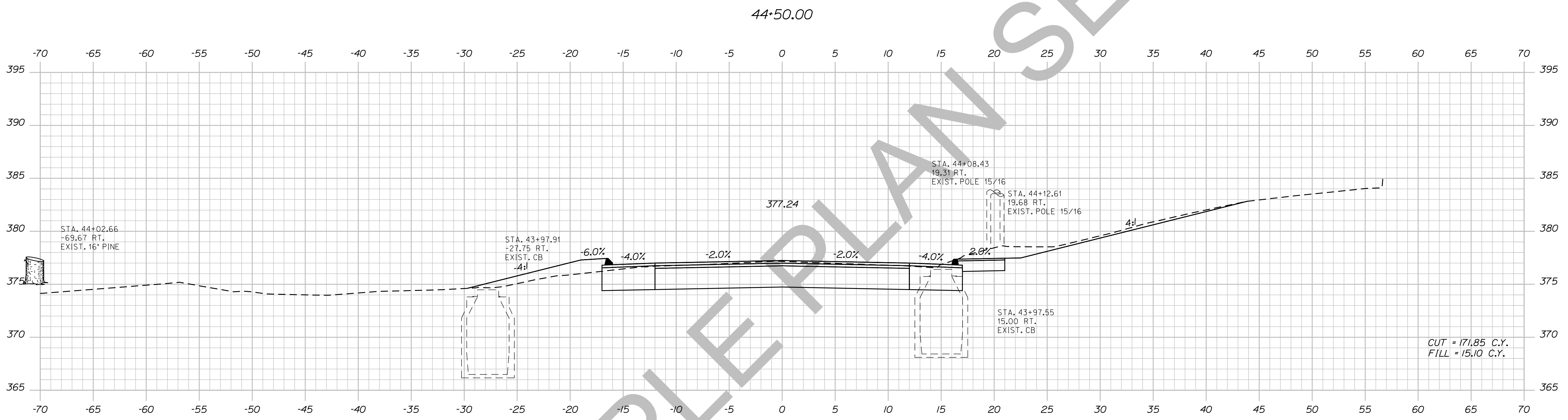
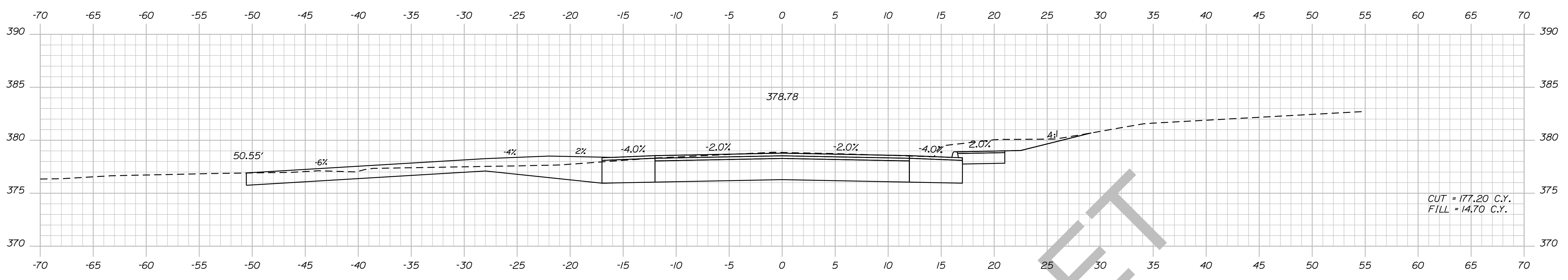

STATE OF MAINE  
DEPARTMENT OF TRANSPORTATION  
018246.00  
PIN  
18246.00  
HIGHWAY PLANS

DESIGN	DATE	BY	PROJ. MGR.	ERNEST MARTIN
DESIGNED				
CHECKED				
DESIGNED				
REVISIONS				
REVISIONS				
REVISIONS				
FIELD CHANGES				

DEXTER  
ROUTE 7  
CROSS SECTIONS

SHEET NUMBER  
74  
OF 15

Date: 5/19/2014

Username: Allee.Mousseau

Division: HIGHWAY

Filename: ... \075\_XSECT\_45+00\_042.dgn

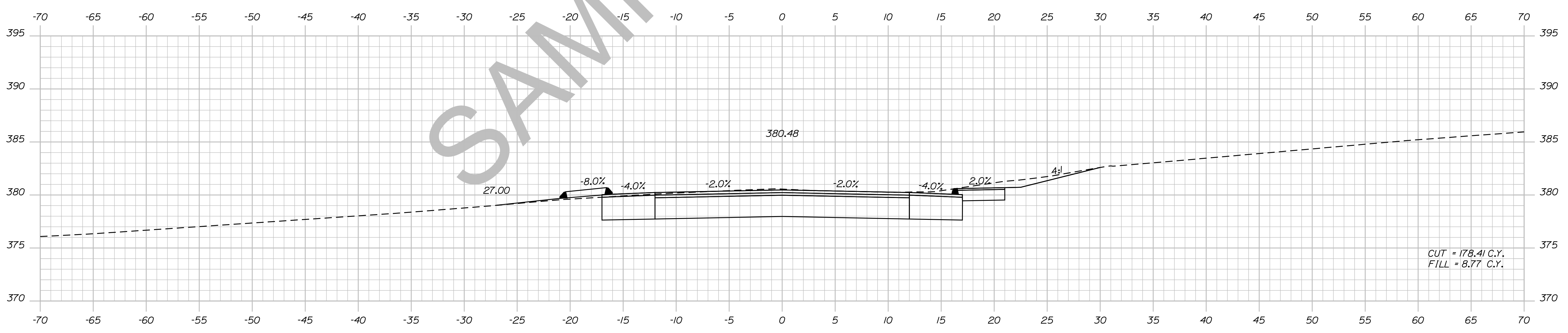
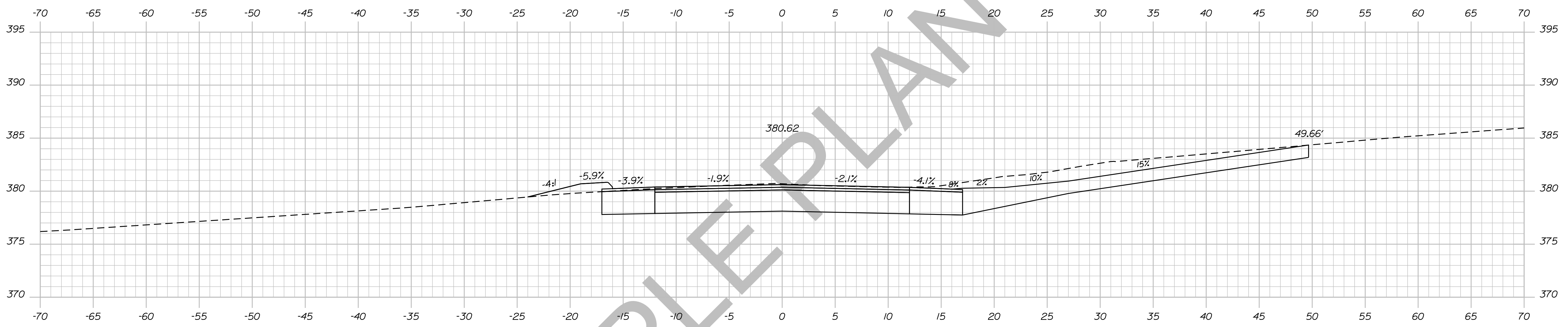
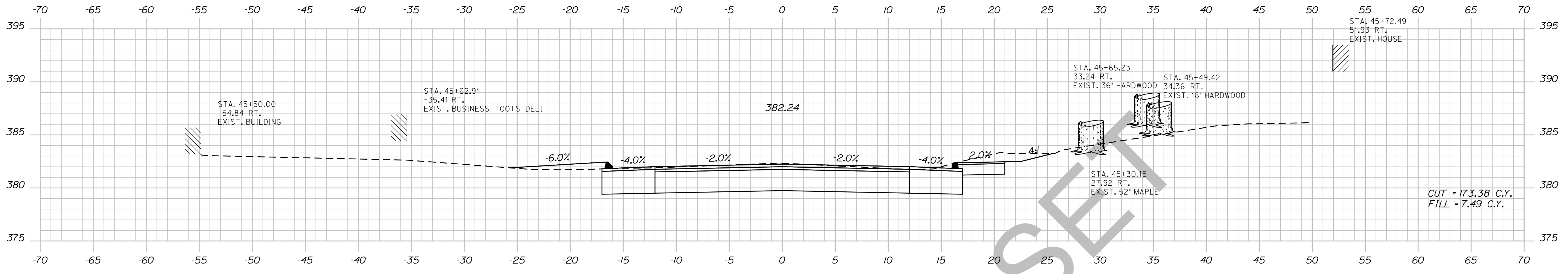

STATE OF MAINE  
DEPARTMENT OF TRANSPORTATION  
018246-00  
PIN 18246.00  
HIGHWAY PLANS

DESIGN	CHECKED	DESIGNED	REVISIONS	FIELD
PROJ. MANAGER: ERNEST MARTIN	TRAVIS WEL			
DATE				
BY				
SIGNATURE				
P.E. NUMBER				
DATE				

DEXTER  
ROUTE 7  
CROSS SECTIONS

SHEET NUMBER  
75  
OF 15



Date: 5/19/2014

Username: Alee.Mousseau

Division: HIGHWAY

Filename: ... \076\_XSECT\_45+65\_043.dgn

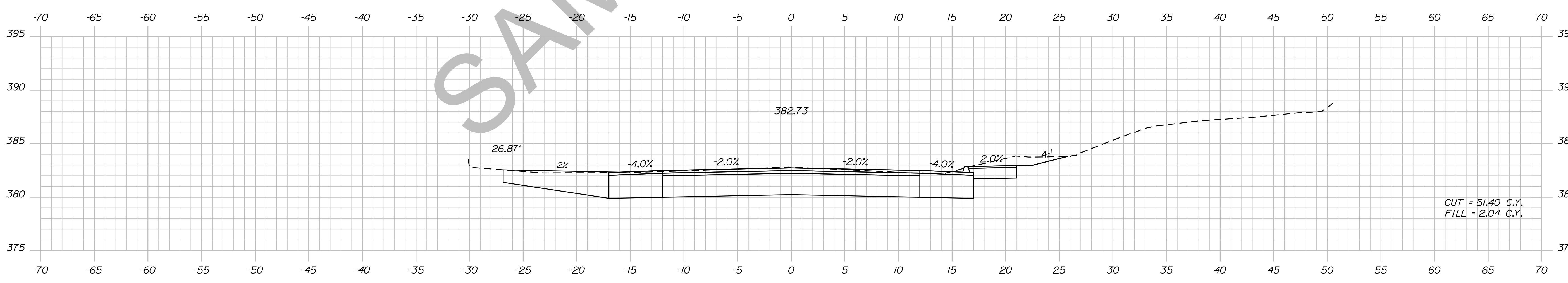
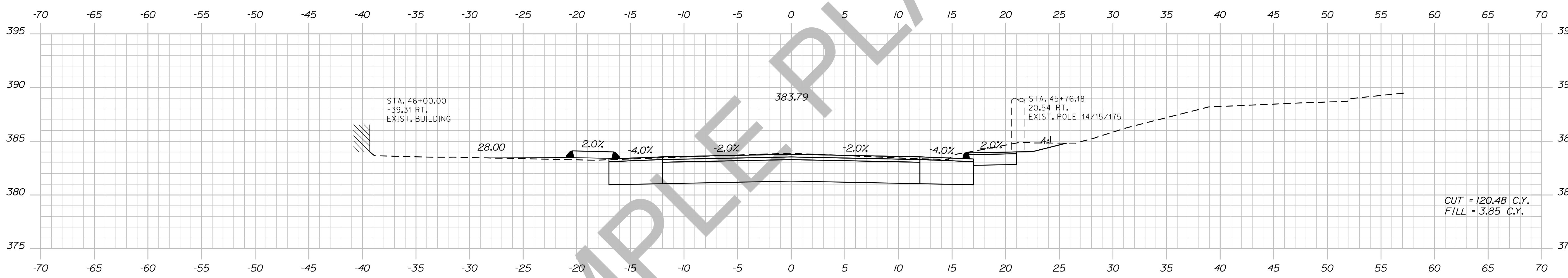
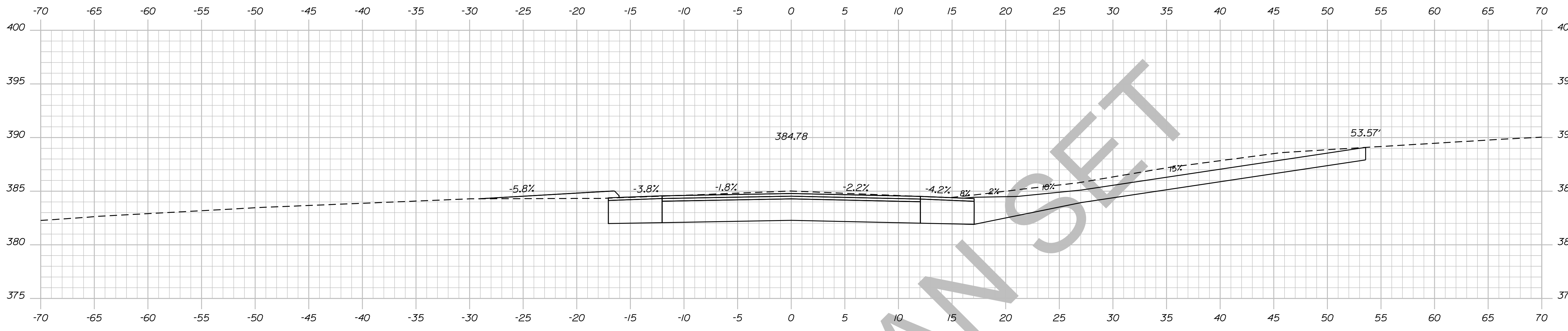

STATE OF MAINE  
DEPARTMENT OF TRANSPORTATION  
018246.00  
PIN 18246.00  
HIGHWAY PLANS

DATE	SIGNATURE	P.E. NUMBER	DATE

PROJ. MANAGER	BY	DATE
ERNEST MARTIN	TRAVIS WHEELER	

DESIGN DETAILED	CHECKED/REVIEWED	DESIGN DETAILED	DESIGN DETAILED	REVISIONS 1	REVISIONS 2	REVISIONS 3	REVISIONS 4	FIELD CHANGES

DEXTER  
ROUTE 7  
CROSS SECTIONS

SHEET NUMBER  
**76**  
OF 15

Date: 5/19/2014

Username: Alee.Mousseau

Division: HIGHWAY

Filename: ... \077\_XSECT\_46+46\_044.dgn

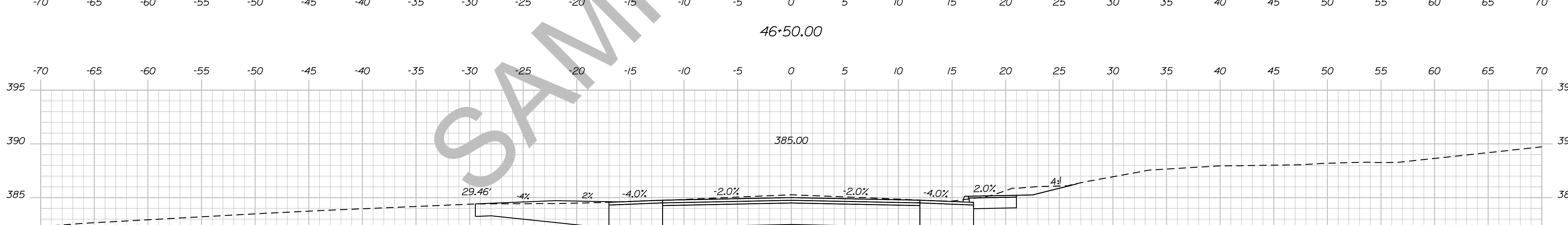
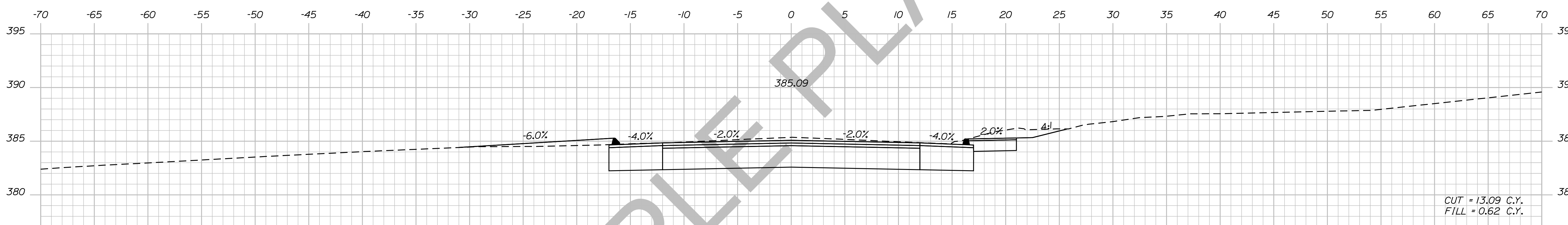
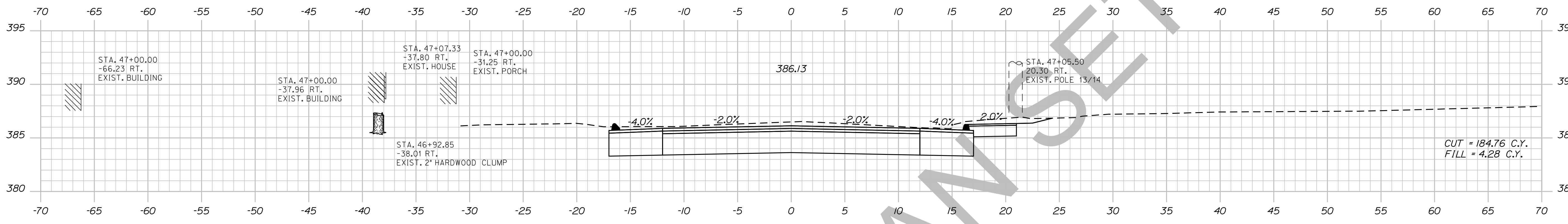

STATE OF MAINE  
DEPARTMENT OF TRANSPORTATION  
018246.00  
PIN 18246.00  
HIGHWAY PLANS

SIGNATURE  
P.E. NUMBER  
DATE

PROJ. MANAGER ERNEST MARTIN  
BY TRAVIS WHEELER  
DATE  
DESIGN CHECKED  
DESIGN REVIEWED  
DESIGN DETAILED  
REVISIONS 1  
REVISIONS 2  
REVISIONS 3  
REVISIONS 4  
FIELD CHANGES

DEXTER  
ROUTE 7  
CROSS SECTIONS

SHEET NUMBER  
77  
OF 15

Date: 5/19/2014

Username: Allee.Mousseau

Division: HIGHWAY

Filename: ... \078\_XSECT\_47+39\_045.dgn

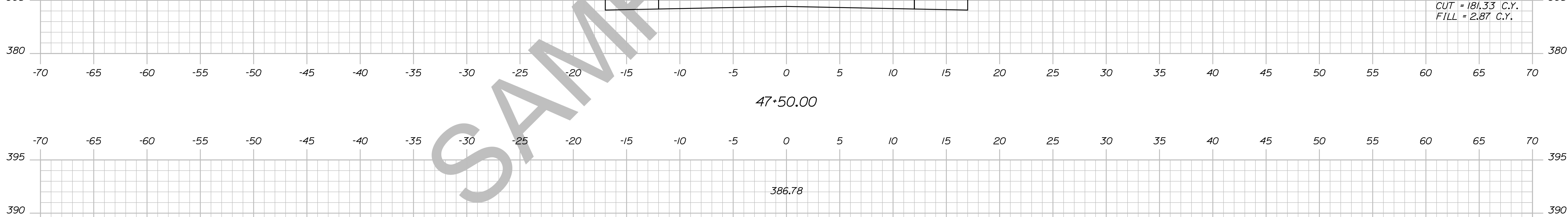
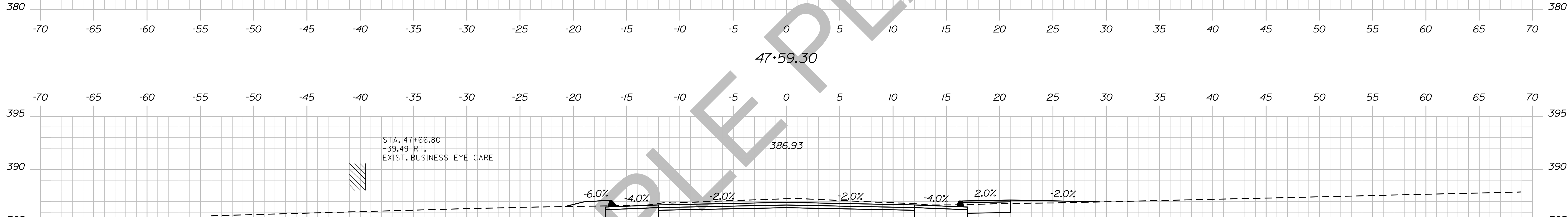
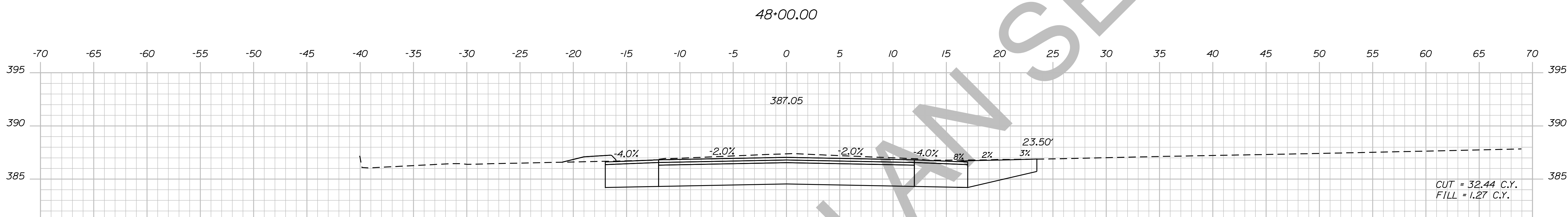
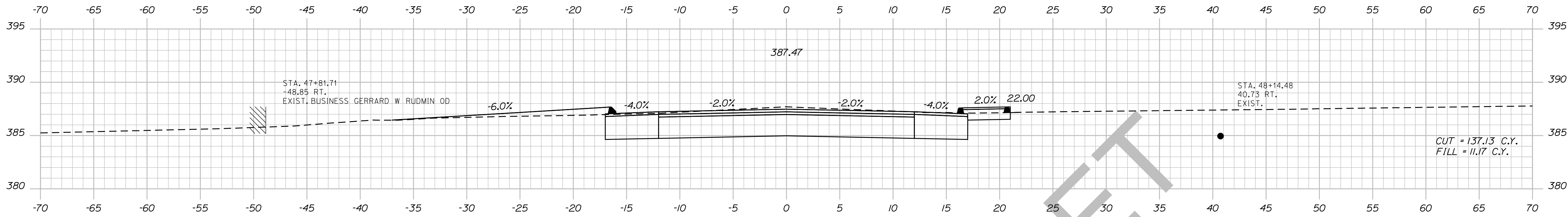

STATE OF MAINE  
DEPARTMENT OF TRANSPORTATION  
018246-00  
PIN 18246.00  
HIGHWAY PLANS

DESIGNED	CHECKED	DATE
TRAVIS W. FELT	ERNEST MARTIN	
DESIGNED	CHECKED	DATE
REVISIONS 1	REVISIONS 2	REVISIONS 3
REVISIONS 4	REVISIONS 5	REVISIONS 6
FIELD CHANGES		

DESIGNED	CHECKED	DATE
TRAVIS W. FELT	ERNEST MARTIN	
DESIGNED	CHECKED	DATE
REVISIONS 1	REVISIONS 2	REVISIONS 3
REVISIONS 4	REVISIONS 5	REVISIONS 6
FIELD CHANGES		

DEXTER  
ROUTE 7  
CROSS SECTIONS

SHEET NUMBER  
78  
OF 15

Date: 5/19/2014

Username: Allee.Mousseau

Division: HIGHWAY

Filename: ... \079\_XSECT\_48+02\_046.dgn

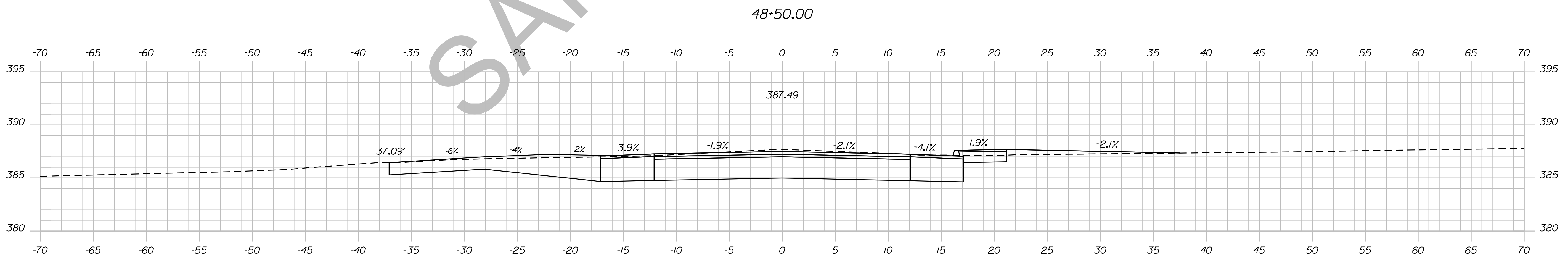
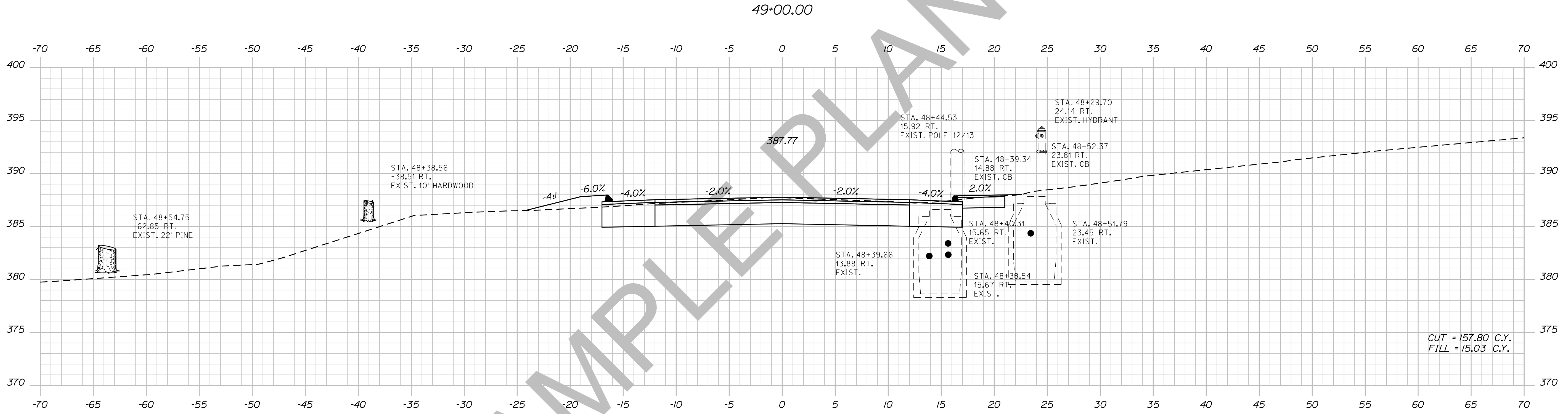
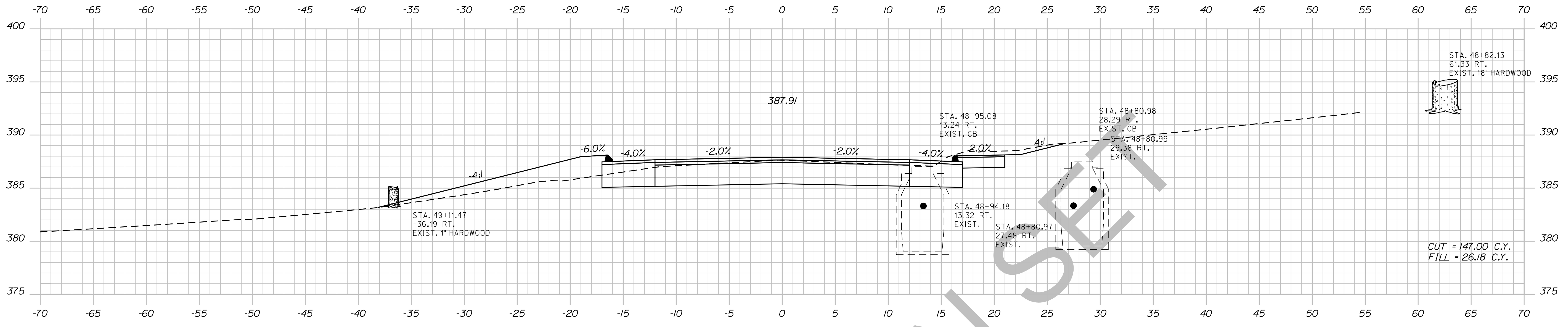

STATE OF MAINE  
DEPARTMENT OF TRANSPORTATION  
018246-00  
PIN 18246.00  
HIGHWAY PLANS

DESIGN	DATE	BY	PROJ. MGR.
DESIGNED			ERNEST MARTIN
CHECKED		TRAVIS WOLFE	
DESIGNED			
REVISIONS			
REVISIONS			
REVISIONS			
REVISIONS			
FIELD CHANGES			

DEXTER  
ROUTE 7  
CROSS SECTIONS

SHEET NUMBER  
**79**  
OF 15

Date: 5/19/2014

Username: Alee.Mousseau

Division: HIGHWAY

Filename: ... \080\_XSECT\_49+50\_047.dgn

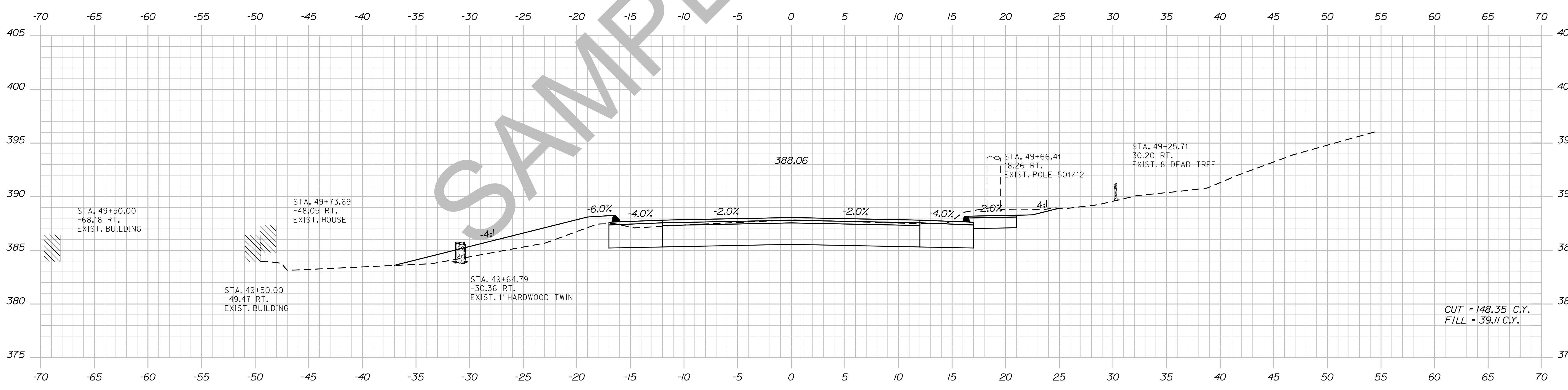
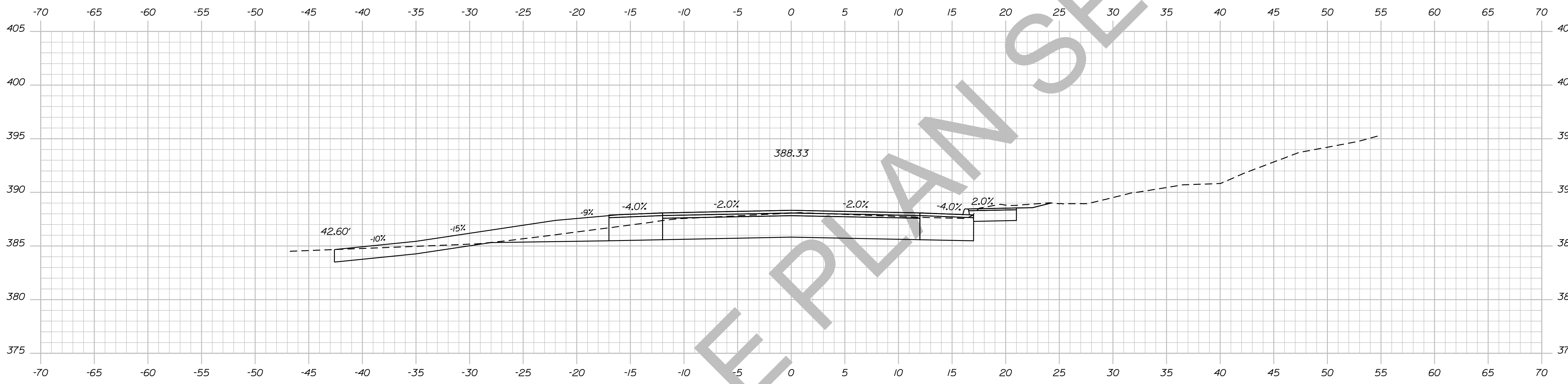

CUT = 148.35 C.Y.  
FILL = 39.11 C.Y.

STATE OF MAINE  
DEPARTMENT OF TRANSPORTATION  
018246.00  
PIN 18246.00  
HIGHWAY PLANS

DESIGN	CHECKED	DESIGNED	REVISIONS	FIELD
PROJ. MANAGER ERNEST MARTIN	TRAVIS WEL			
DESIGN-DETAILED				
CHECKED-REVIEWED				
DESIGN-DETAILED				
DESIGN-DETAILED				
REVISIONS 1				
REVISIONS 2				
REVISIONS 3				
REVISIONS 4				
FIELD CHANGES				

DEXTER  
ROUTE 7  
CROSS SECTIONS

SHEET NUMBER  
**80**  
OF 15

Sta. 49+50.00 to Sta. 49+85.96



Date: 5/19/2014

Username: Alee.Mousseau

Division: HIGHWAY

Filename: ... \081\_XSECT\_50+00\_048.dgn

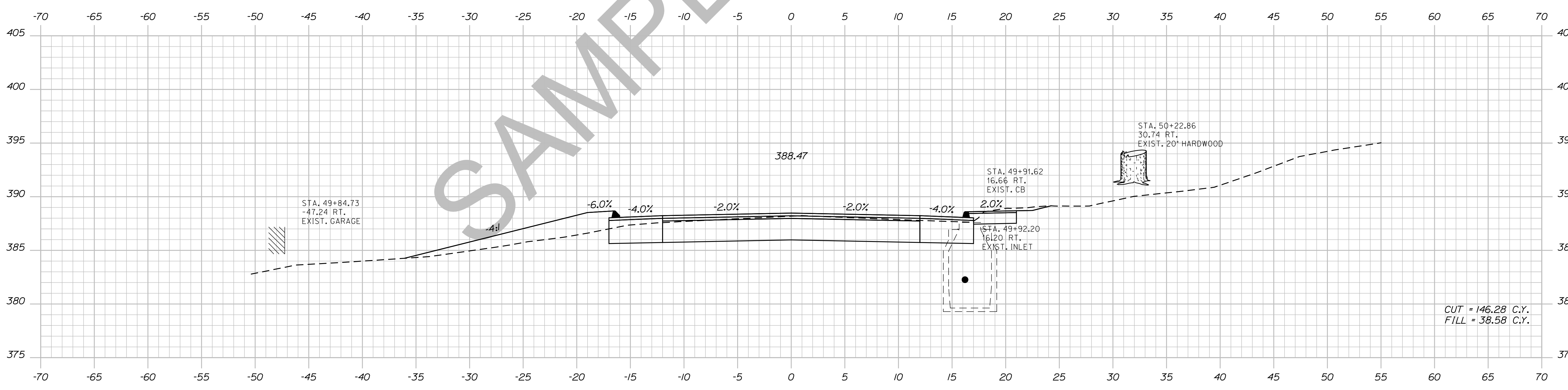
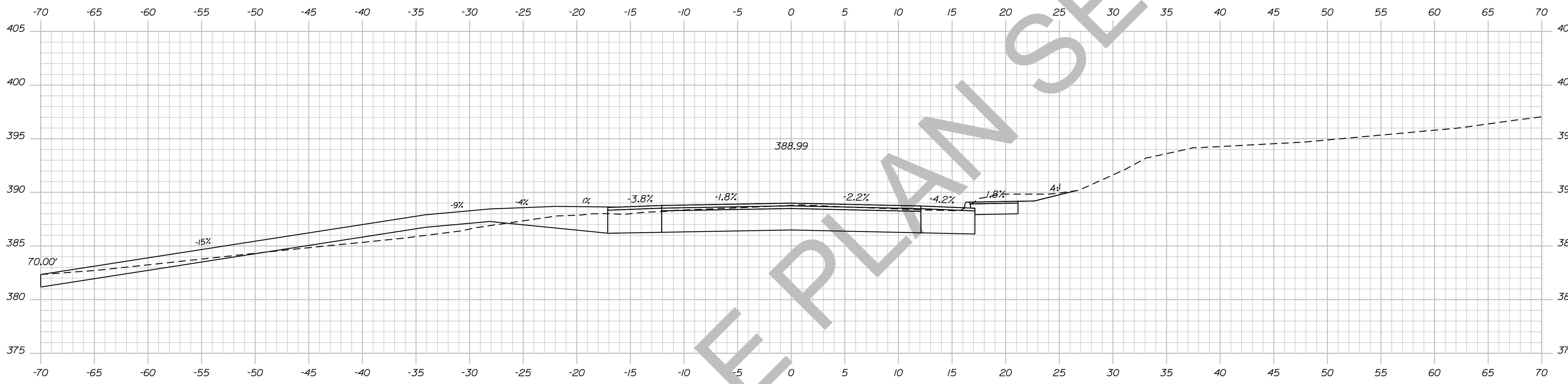

STATE OF MAINE  
DEPARTMENT OF TRANSPORTATION  
018246.00  
PIN 18246.00  
HIGHWAY PLANS

SIGNATURE  
P.E. NUMBER  
DATE

PROJ. MANAGER	ERNEST MARTIN	BY	DATE
CHECKED-REVIEWED	TRAVIS WEL		
DESIGN DETAILED			
DESIGN DETAILED			
REVISIONS 1			
REVISIONS 2			
REVISIONS 3			
REVISIONS 4			
FIELD CHANGES			

DEXTER  
ROUTE 7  
CROSS SECTIONS

SHEET NUMBER  
**81**  
OF 15

Date: 5/19/2014

Username: Alee.Mousseau

Division: HIGHWAY

Filename: ... \082\_XSECT\_50+50\_049.dgn

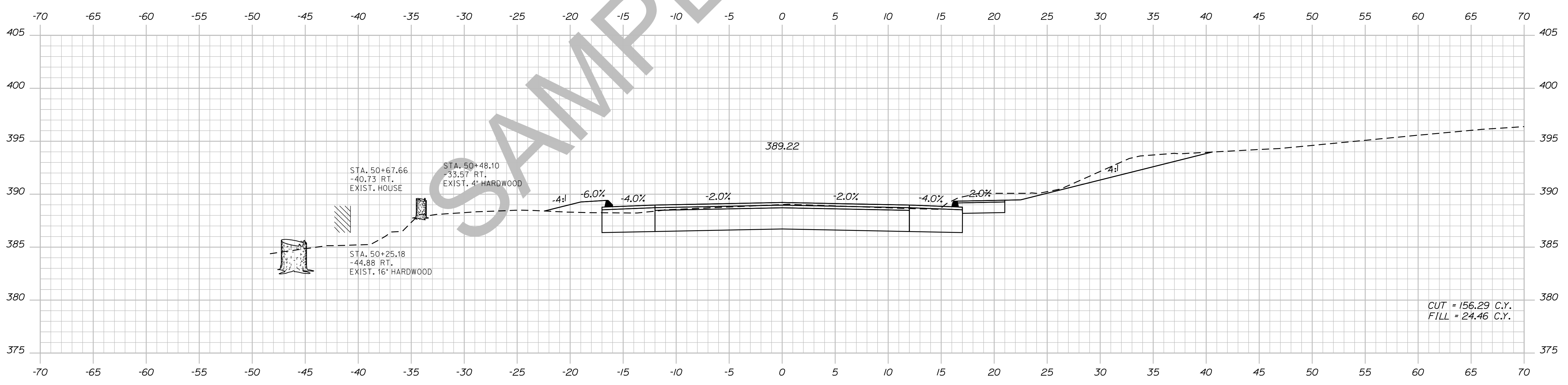
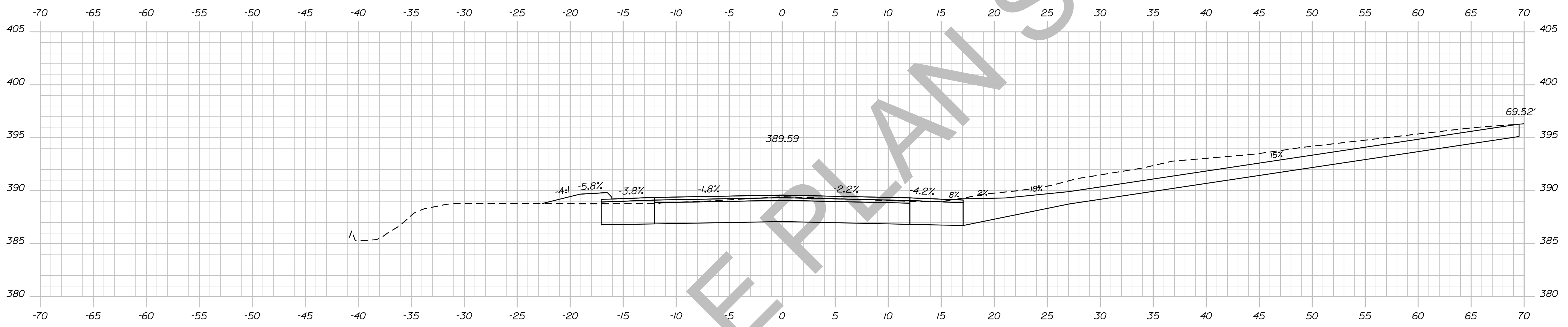

STATE OF MAINE  
DEPARTMENT OF TRANSPORTATION  
018246-00  
PIN 18246.00  
HIGHWAY PLANS

DESIGN-DETAILED	CHECKED-REVIEWED	DESIGN-DETAILED	DESIGN-DETAILED	REVISIONS 1	REVISIONS 2	REVISIONS 3	REVISIONS 4	FIELD CHANGES
TRAVIS WEL								
SIGNATURE								DATE
P.E. NUMBER								DATE

DEXTER  
ROUTE 7  
CROSS SECTIONS

SHEET NUMBER  
**82**  
OF 15

Date: 5/19/2014

Username: Alee.Mousseau

Division: HIGHWAY

Filename: ... \083\_XSECT\_51+00\_050.dgn

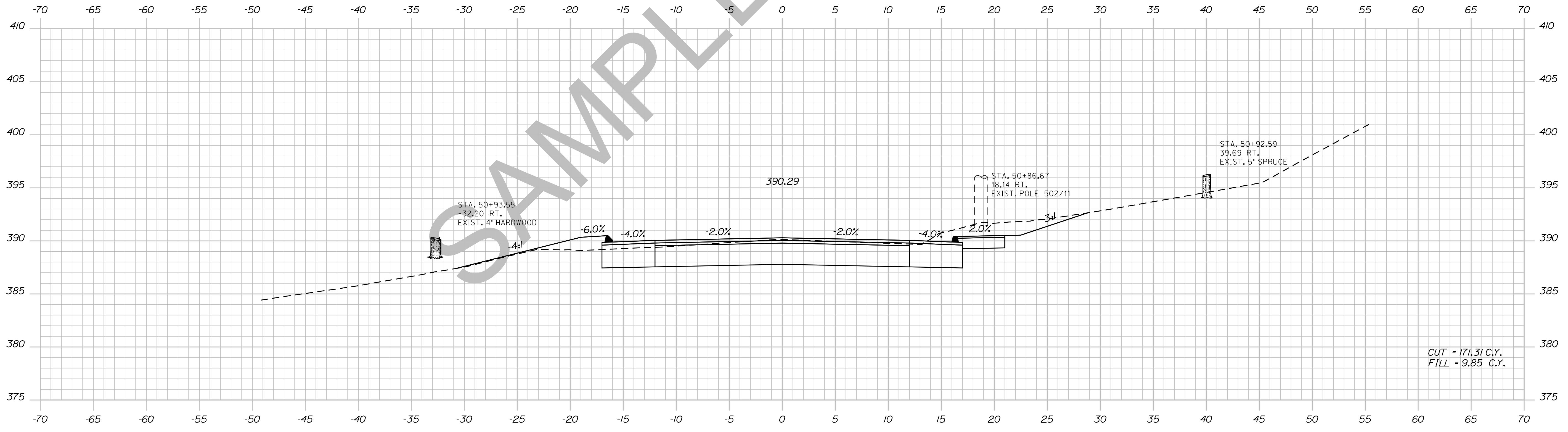
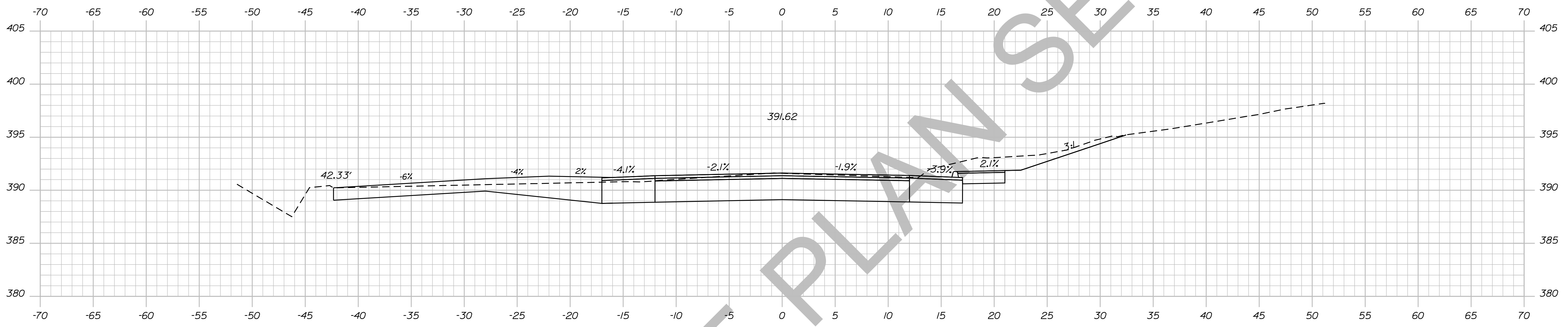

STATE OF MAINE  
DEPARTMENT OF TRANSPORTATION  
018246.00  
PIN  
18246.00  
HIGHWAY PLANS

PROJ. MANAGER	ERNEST MARTIN	BY	DATE
CHECKED-REVIEWED	TRAVIS WOLFE		
DESIGNS DETAILED		SIGNATURE	
DESIGNS DETAILED		P.E. NUMBER	
REVISIONS 1		DATE	
REVISIONS 2			
REVISIONS 3			
REVISIONS 4			
FIELD CHANGES			

DEXTER  
ROUTE 7  
CROSS SECTIONS

SHEET NUMBER  
**83**  
OF 15

Date: 5/19/2014

Username: Alee.Mousseau

Division: HIGHWAY

Filename: ... \084\_XSECT\_51+50\_051.dgn

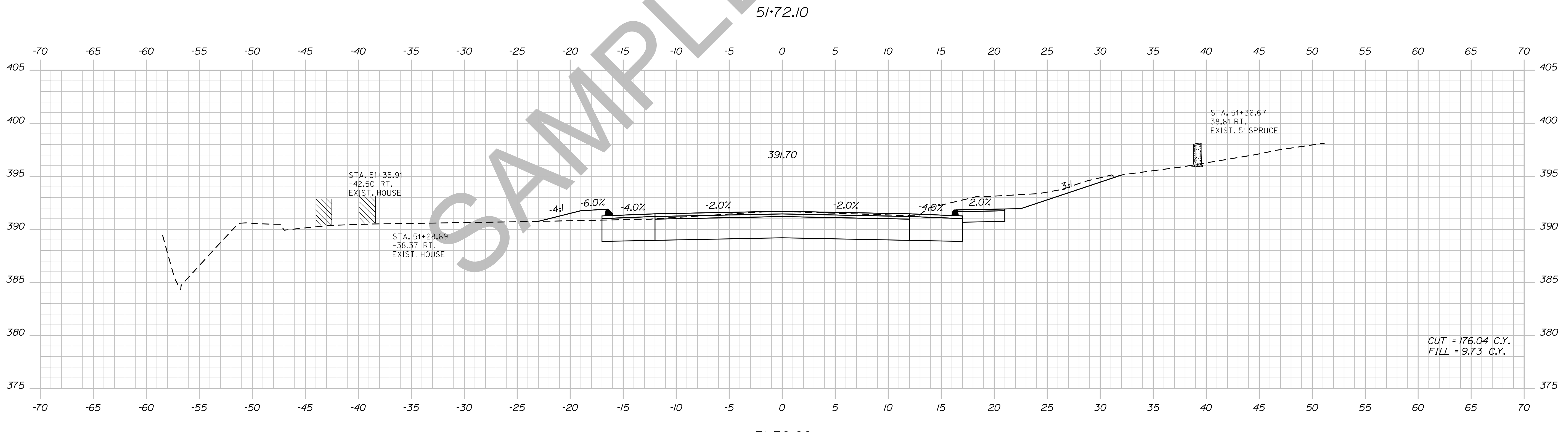
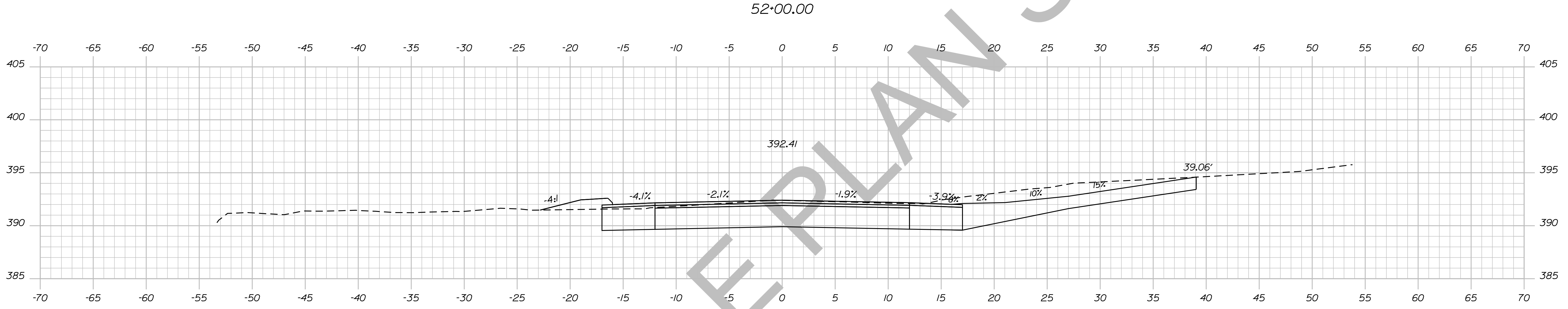
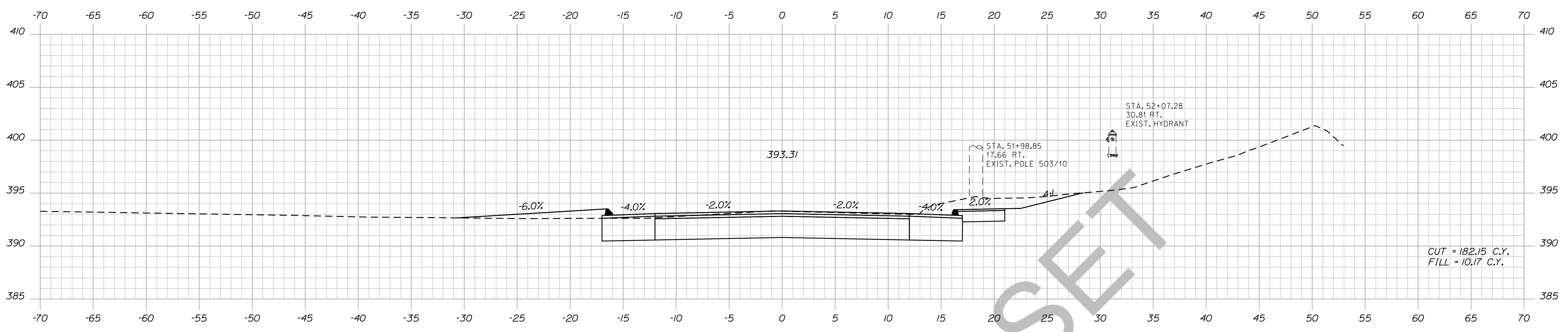

STATE OF MAINE  
DEPARTMENT OF TRANSPORTATION  
018246.00  
PIN 18246.00  
HIGHWAY PLANS

DESIGN-DETAILED	CHECKED-REVIEWED	DESIGN-DETAILED	DESIGN-DETAILED	REVISIONS 1	REVISIONS 2	REVISIONS 3	REVISIONS 4	FIELD CHANGES
TRAVIS WOLFE								
PROJ. MANAGER	ERNEST MARTIN	BY	DATE	SIGNATURE	P.E. NUMBER	DATE		

DEXTER  
ROUTE 7  
CROSS SECTIONS

SHEET NUMBER  
**84**  
OF 15

Date: 5/19/2014

Username: Alee.Mousseau

Division: HIGHWAY

Filename: ... \085\_XSECT\_52+20\_052.dgn

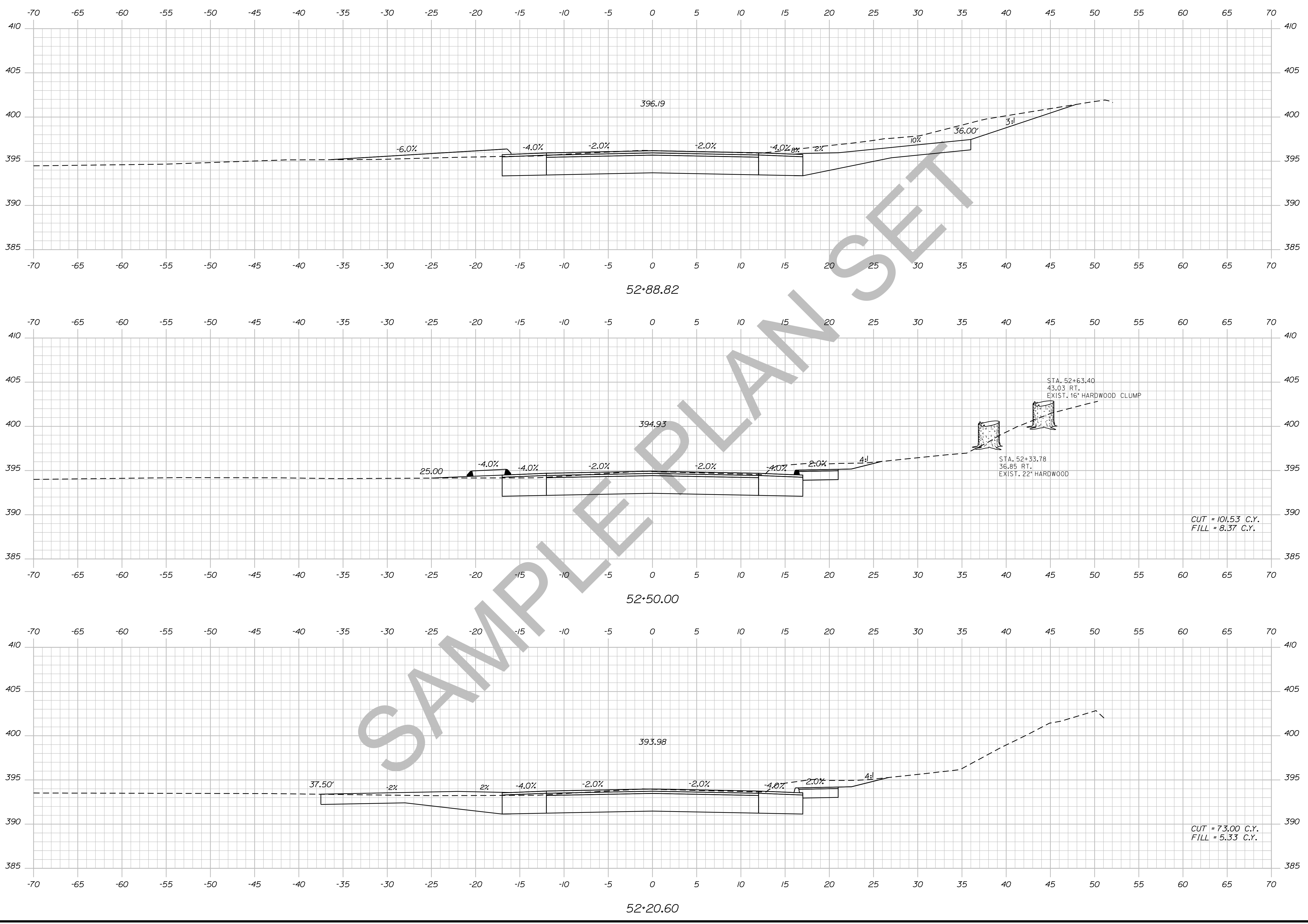

STATE OF MAINE DEPARTMENT OF TRANSPORTATION		018246-00		PIN 18246.00		HIGHWAY PLANS	
SIGNATURE		P.E. NUMBER		DATE		CROSS SECTIONS	
PROJ. MANAGER	ERNEST MARTIN	BY	TRAVIS WOLFE	DATE		SHEET NUMBER	
DESIGN-DETAILED		CHECKED-REVIEWED		DESIGN-DETAILED		85	
DESIGN-DETAILED		DESIGN-DETAILED		REVISIONS 1		OF 15	
		REVISIONS 2		REVISIONS 3		Sta. 52+20.60 to Sta. 52+88.82	
		REVISIONS 4		FIELD CHANGES			



Date: 5/19/2014

Username: Alee.Mousseau

Division: HIGHWAY

Filename: ... \086\_XSECT\_53+00\_053.dgn

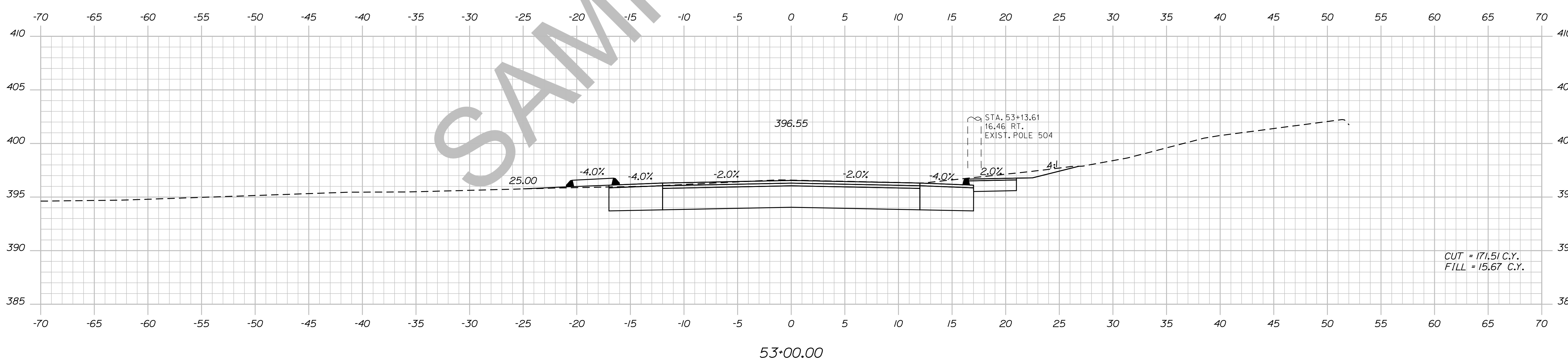
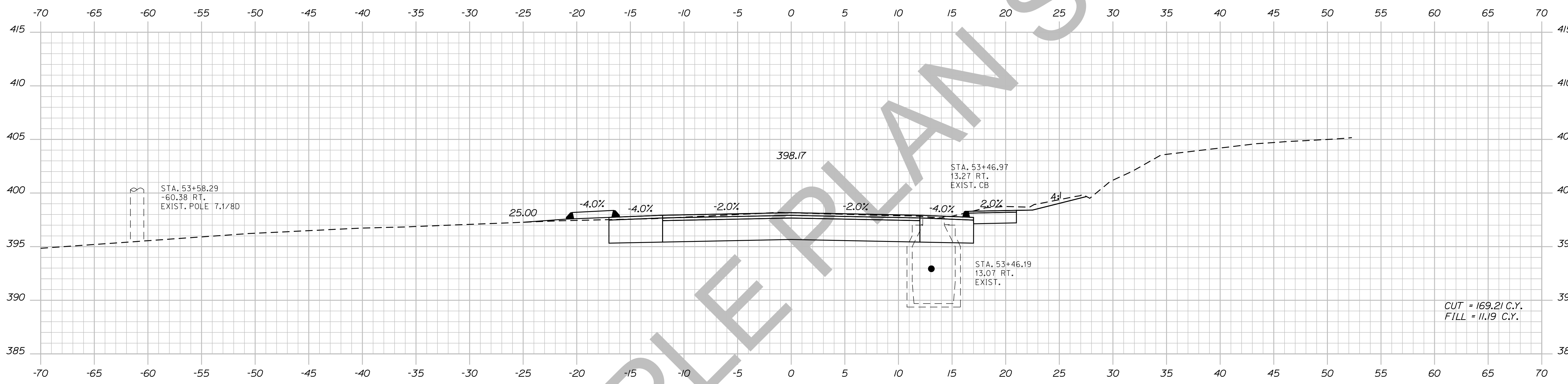

SAMPLE PLAN SET

STATE OF MAINE  
DEPARTMENT OF TRANSPORTATION  
018246.00  
PIN 18246.00  
HIGHWAY PLANS

PROJ. MANAGER	ERNEST MARTIN	BY	DATE
DESIGN-DETAILED	TRAVIS WELT		
CHECKED-REVIEWED			
DESIGN-DETAILED			
REVISIONS 1			
REVISIONS 2			
REVISIONS 3			
REVISIONS 4			
FIELD CHANGES			

DEXTER  
ROUTE 7  
CROSS SECTIONS

SHEET NUMBER  
**86**  
OF 15

Date: 5/19/2014

Username: Alee.Mousseau

Division: HIGHWAY

Filename: ... \087\_XSECT\_54+00\_054.dgn

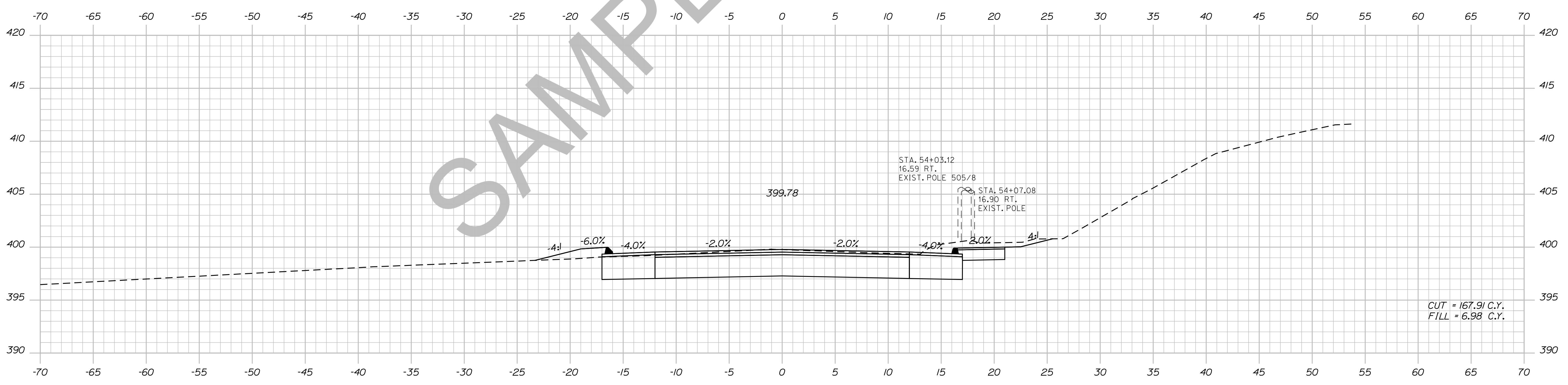
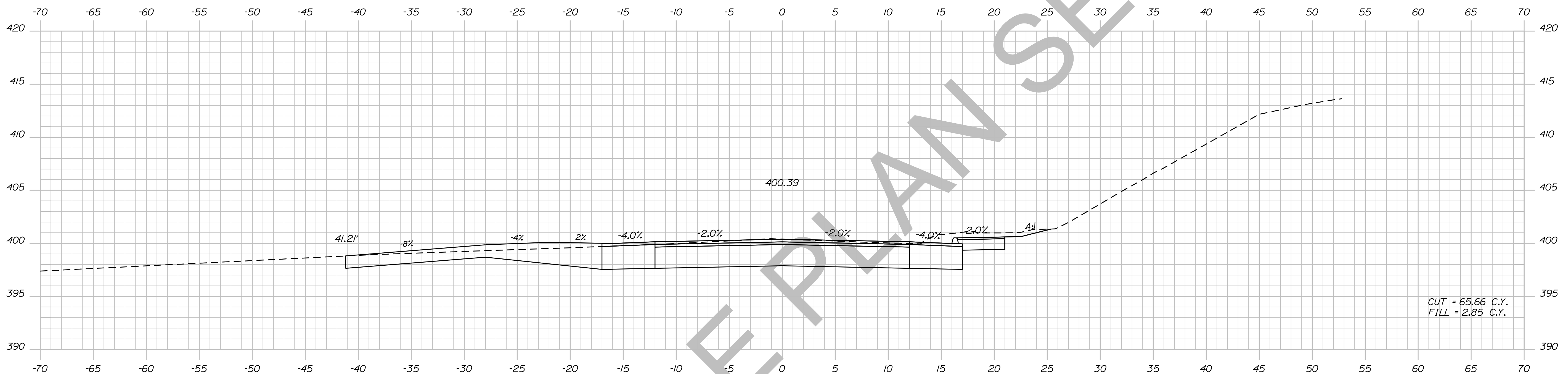

STATE OF MAINE  
DEPARTMENT OF TRANSPORTATION  
018246.00  
PIN  
18246.00  
HIGHWAY PLANS

SIGNATURE  
P.E. NUMBER  
DATE

PROJ. MANAGER	ERNEST MARTIN	BY	DATE
CHECKED-REVIEWED	TRAVIS WOLFE		
DESIGNS DETAILED			
REVISIONS 1			
REVISIONS 2			
REVISIONS 3			
REVISIONS 4			
FIELD CHANGES			

DEXTER  
ROUTE 7  
CROSS SECTIONS

SHEET NUMBER  
87  
OF 15

Date: 5/19/2014

Username: Alee.Mousseau

Division: HIGHWAY

Filename: ... \088\_XSECT\_54+50\_055.dgn

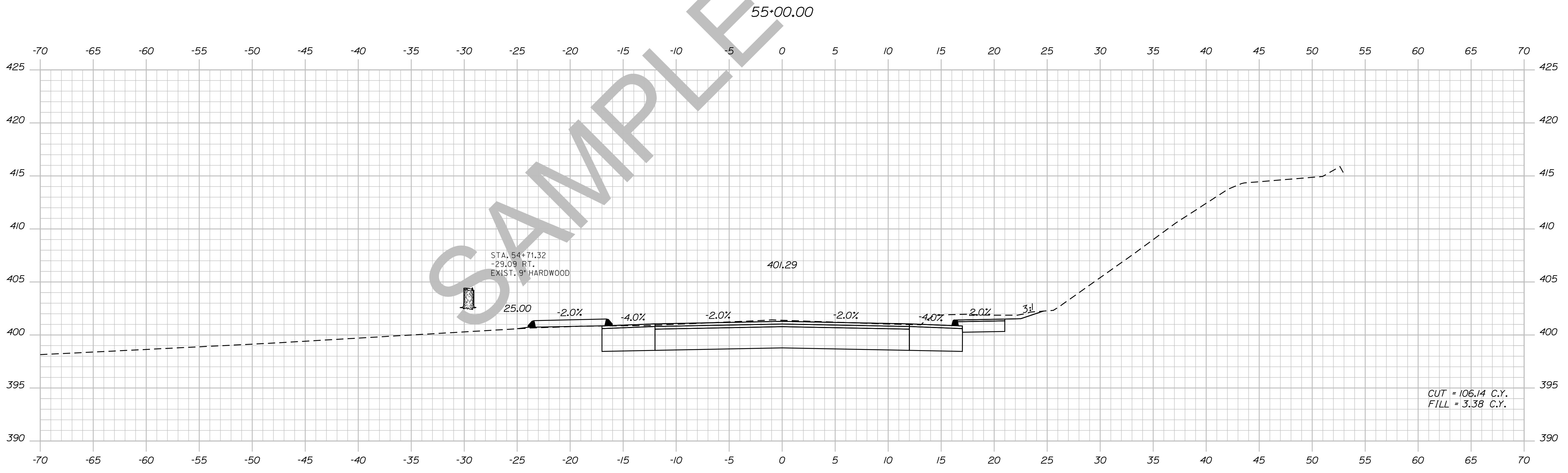
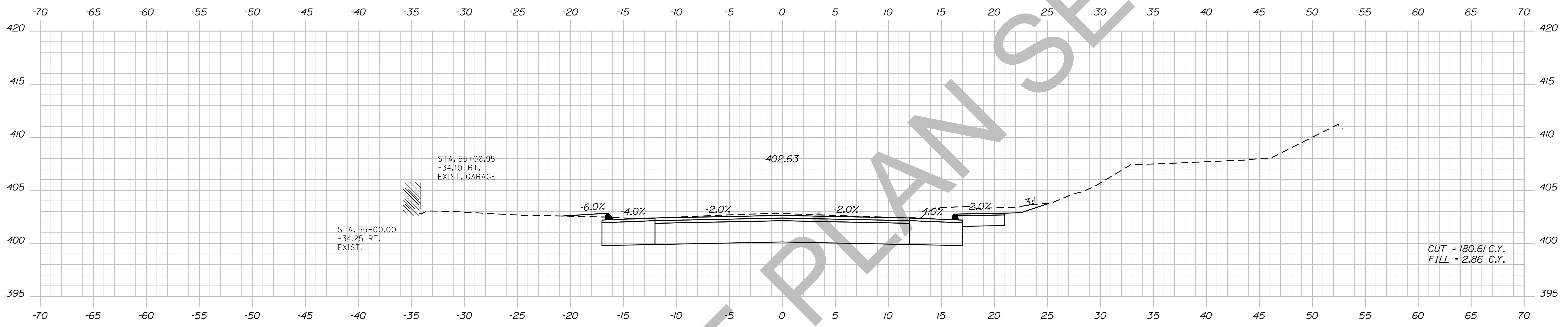

STATE OF MAINE  
DEPARTMENT OF TRANSPORTATION  
018246.00  
PIN  
18246.00  
HIGHWAY PLANS

PROJ. MANAGER	ERNEST MARTIN	BY	DATE
CHECKED-REVIEWED	TRAVIS WHEL		
DESIGNED-DETAILED			
DESIGNED-DETAILED			
REVISIONS 1			
REVISIONS 2			
REVISIONS 3			
REVISIONS 4			
FIELD CHANGES			

DEXTER  
ROUTE 7  
CROSS SECTIONS

SHEET NUMBER  
**88**  
OF 15

Date: 5/19/2014

Username: Ailee.Mousseau

Division: HIGHWAY

Filename: ... \089\_XSECT\_55+02\_056.dgn

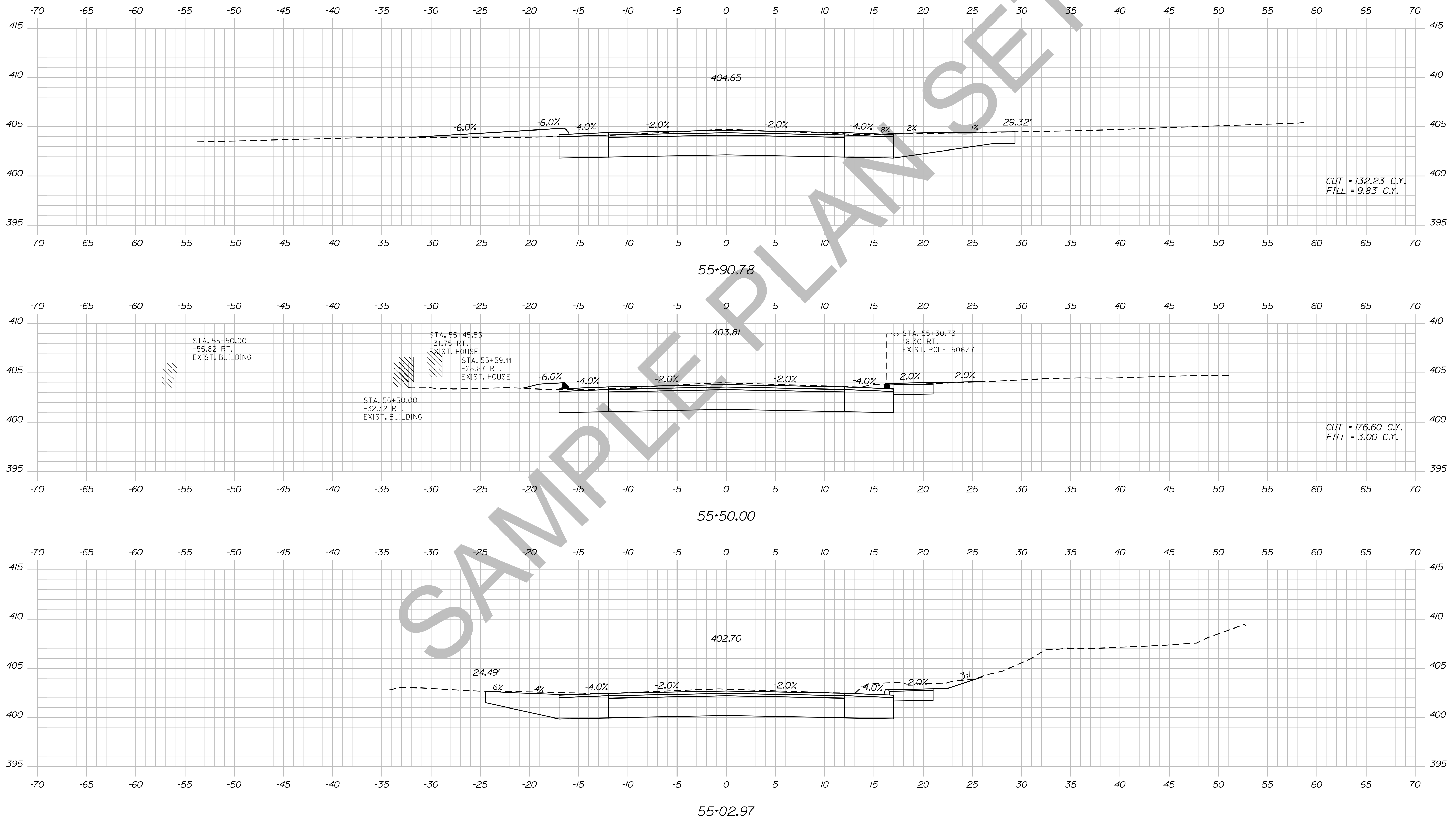

STATE OF MAINE  
DEPARTMENT OF TRANSPORTATION  
018246.00  
PIN  
18246.00  
HIGHWAY PLANS

DATE	BY	SIGNATURE	P.E. NUMBER	DATE
	PROJ. MANAGER ERNEST MARTIN			
	DESIGN-DETAILED TRAVIS WOLFE			
	CHECKED-REVIEWED			
	DESIGNS DET AILED			
	DESIGNS DET AILED			
	REVISIONS 1			
	REVISIONS 2			
	REVISIONS 3			
	REVISIONS 4			
	FIELD CHANGES			

DEXTER  
ROUTE 7  
CROSS SECTIONS

SHEET NUMBER  
**89**  
OF 15

Date: 5/19/2014

Username: Alee.Mousseau

Division: HIGHWAY

Filename: ... \090\_XSECT\_56+00\_057.dgn

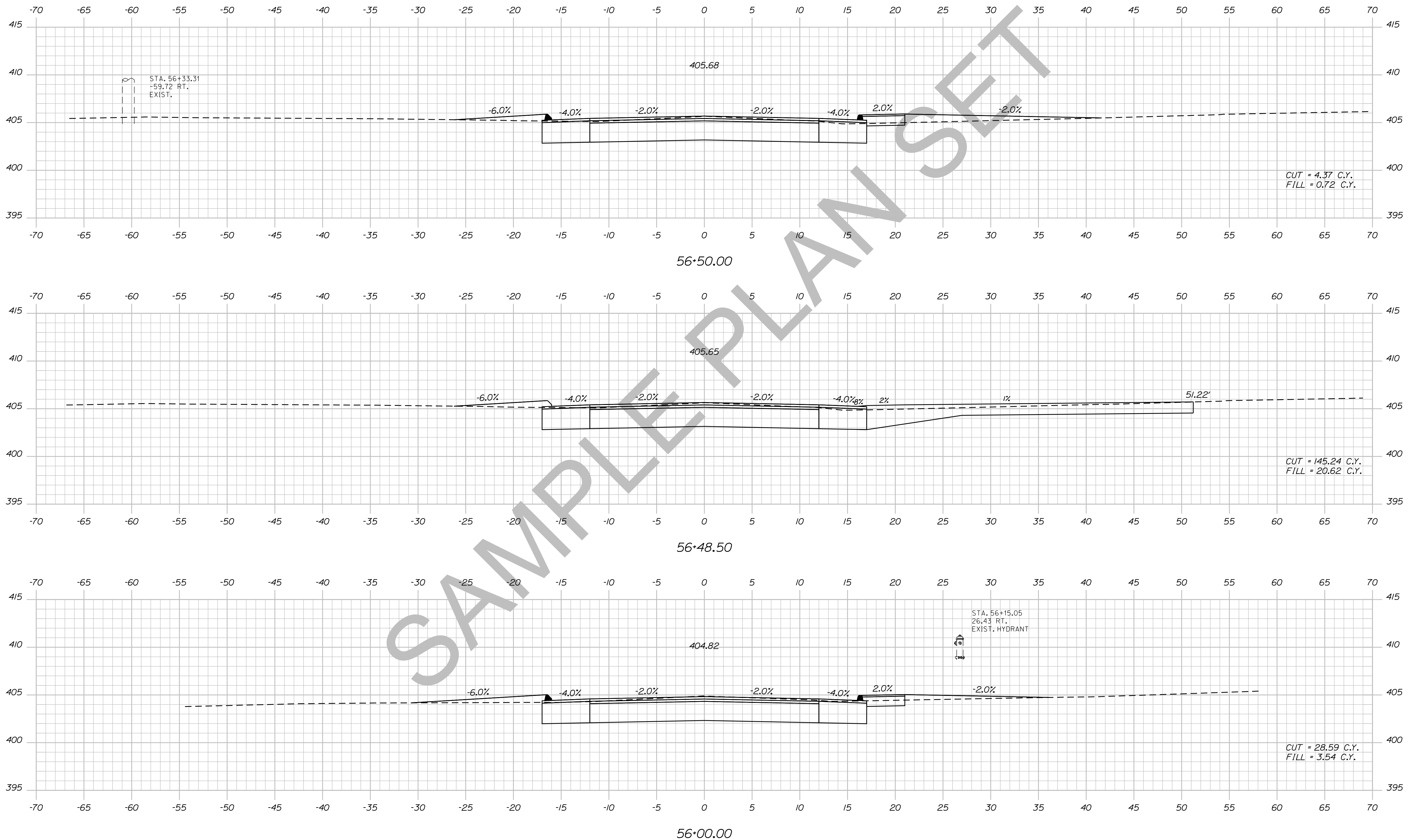

STATE OF MAINE  
DEPARTMENT OF TRANSPORTATION  
018246.00  
PIN 18246.00  
HIGHWAY PLANS

DATE	BY	PROJ. MANAGER	ERNEST MARTIN	TRAVIS WOLFE
		DESIGN DETAILED		
		CHECKED/REVIEWED		
		DESIGNS DETAILED		
		REVISIONS 1		
		REVISIONS 2		
		REVISIONS 3		
		REVISIONS 4		
		FIELD CHANGES		

DEXTER  
ROUTE 7  
CROSS SECTIONS

SHEET NUMBER  
**90**  
OF 15

Username: Alee.Mousseau Date: 5/19/2014

Division: HIGHWAY

Filename: ... \091\_XSECT\_57+00\_058.dgn

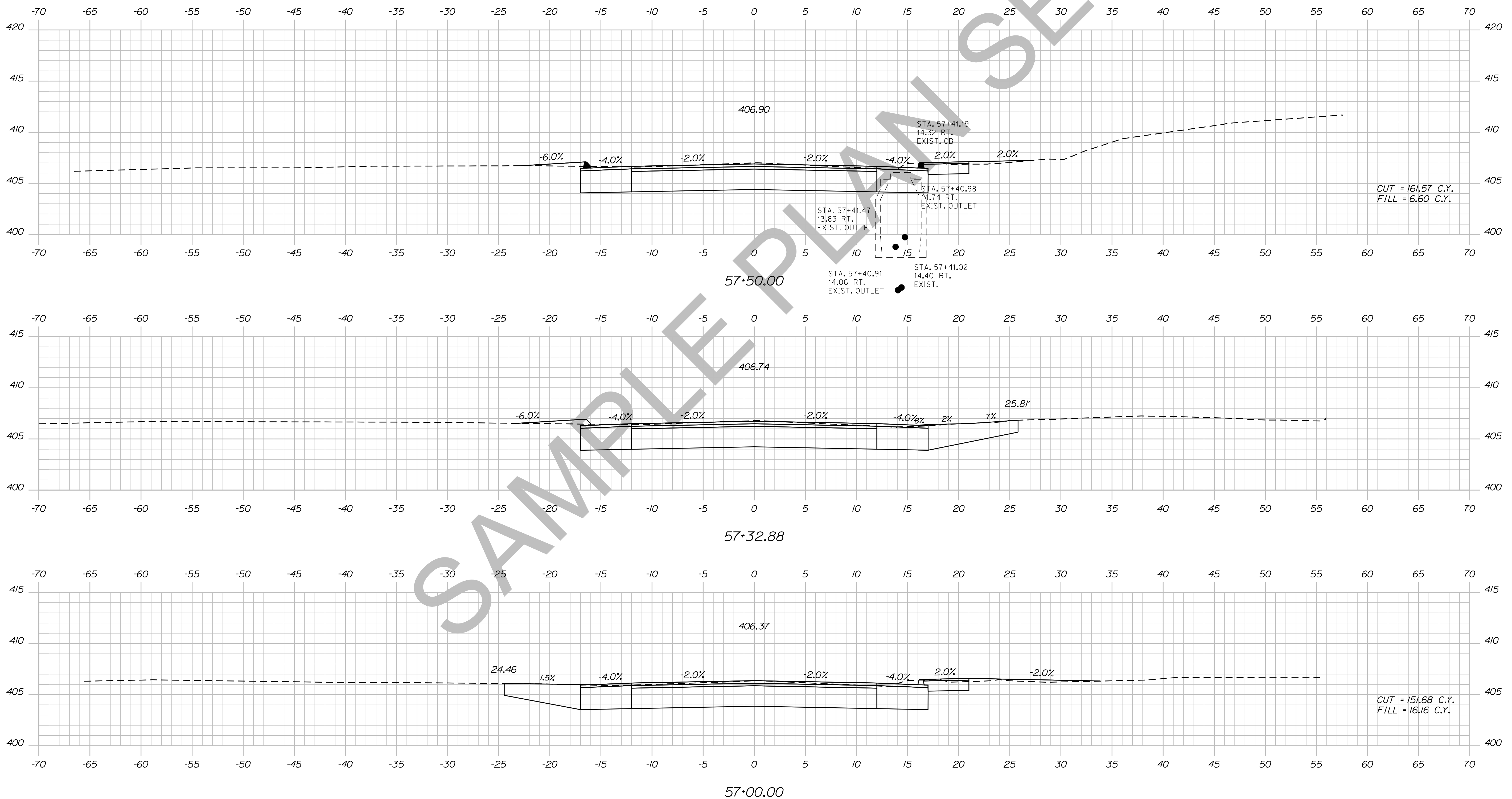

STATE OF MAINE  
DEPARTMENT OF TRANSPORTATION  
018246.00  
PIN 18246.00  
HIGHWAY PLANS

PROJ. MANAGER	ERNEST MARTIN	BY	DATE	SIGNATURE	P.E. NUMBER	DATE
DESIGN/DETAILED	TRAVIS WHEELER					
CHECKED/REVIEWED						
DESIGN/DETAILED						
REVISIONS 1						
REVISIONS 2						
REVISIONS 3						
REVISIONS 4						
FIELD CHANGES						

DEXTER  
ROUTE 7  
CROSS SECTIONS

SHEET NUMBER  
**91**  
OF 15



Date: 5/19/2014

Username: Alee.Mousseau

Division: HIGHWAY

Filename: ... \092\_XSECT\_58+00\_059.dgn

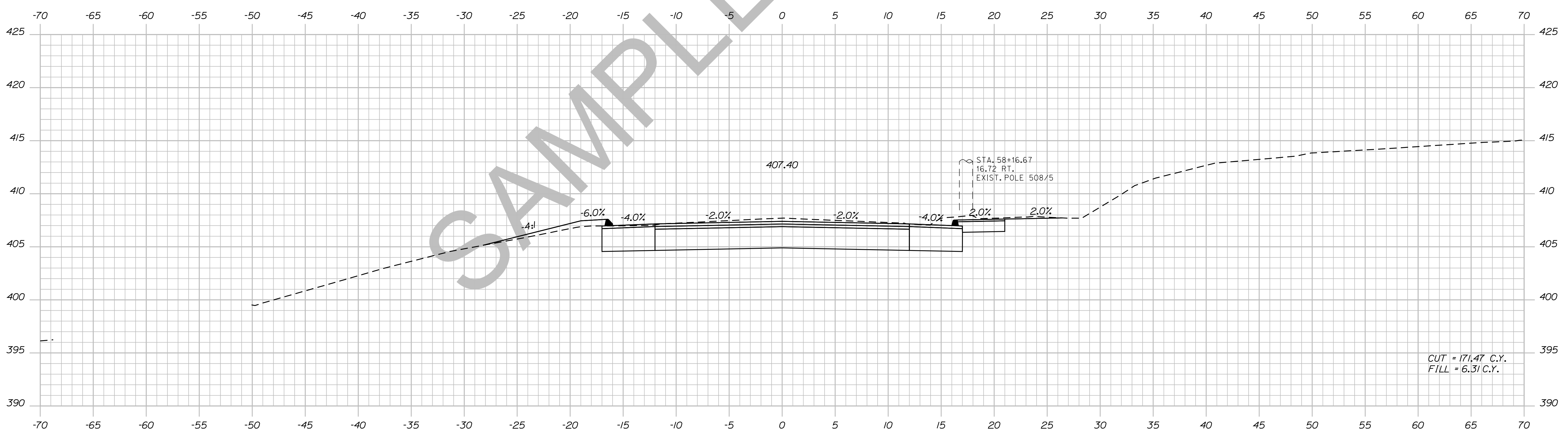
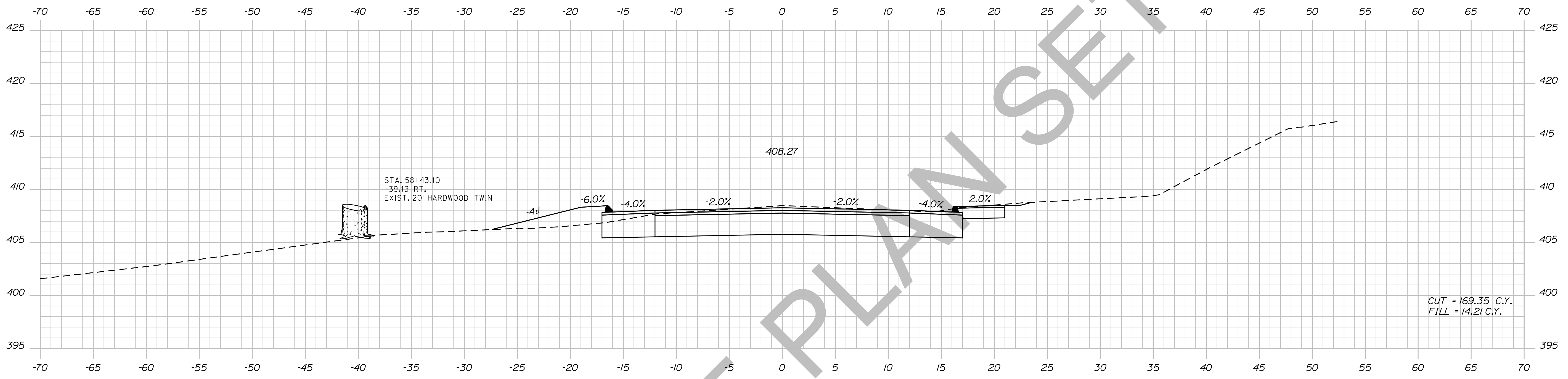

STATE OF MAINE  
DEPARTMENT OF TRANSPORTATION  
018246.00  
PIN  
18246.00  
HIGHWAY PLANS

PROJ. MANAGER	ERNEST MARTIN	BY	DATE
CHECKED-REVIEWED	TRAVIS WHEL		
DESIGNS DETAILED		SIGNATURE	
REVISIONS 1		P.E. NUMBER	
REVISIONS 2		DATE	
REVISIONS 3			
REVISIONS 4			
FIELD CHANGES			

DEXTER  
ROUTE 7  
CROSS SECTIONS

SHEET NUMBER  
**92**  
OF 15

Date: 5/19/2014

Username: Alee.Mousseau

Division: HIGHWAY

Filename: ... \093\_XSECT\_58+53\_060.dgn

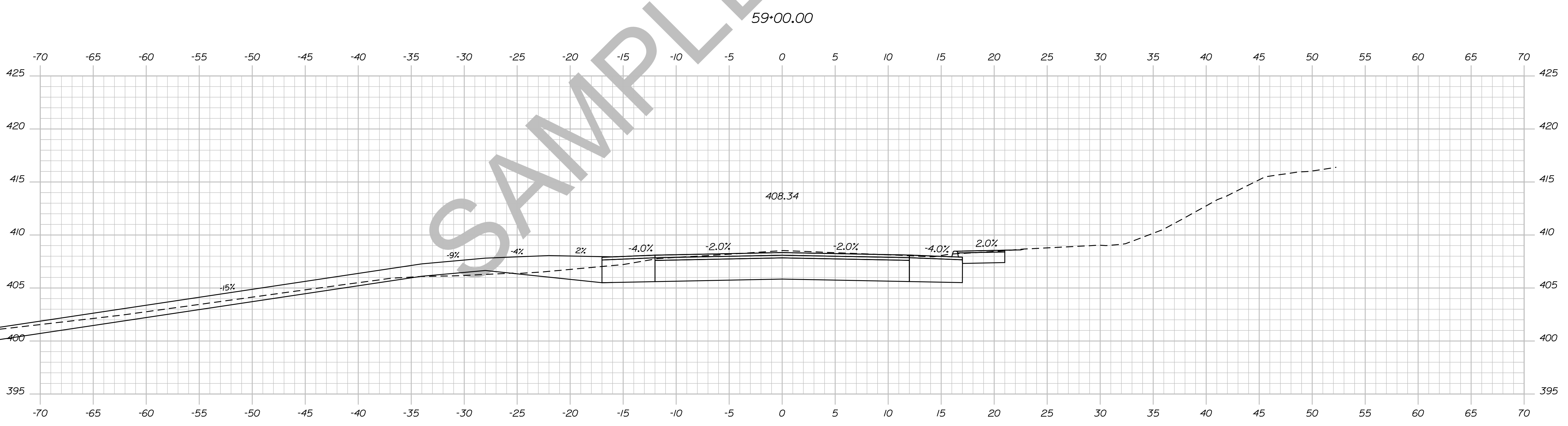
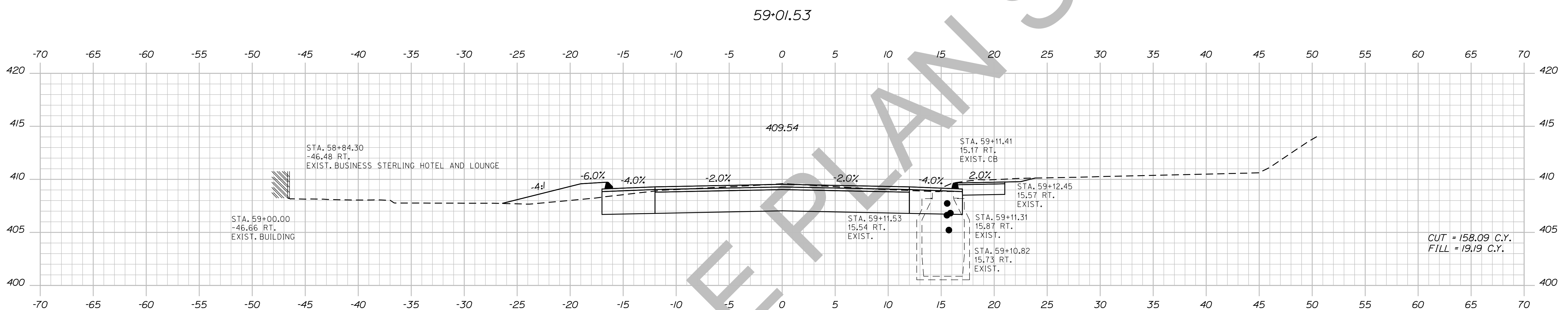
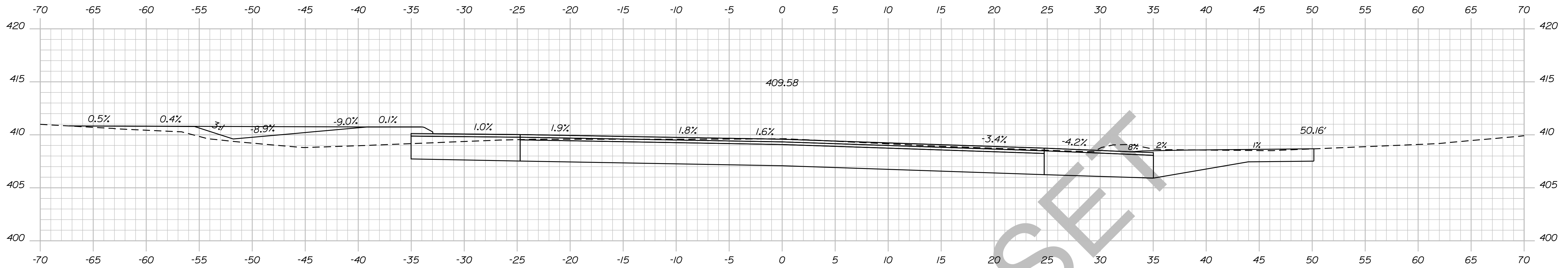

STATE OF MAINE  
DEPARTMENT OF TRANSPORTATION  
018246.00  
PIN 18246.00  
HIGHWAY PLANS

DESIGN-DETAILED	CHECKED-REVIEWED	DESIGN-DETAILED	DESIGN-DETAILED	REVISIONS 1	REVISIONS 2	REVISIONS 3	REVISIONS 4	FIELD CHANGES
PROJ. MANAGER ERNEST MARTIN	BY TRAVIS WOLFE	DATE	SIGNATURE	P.E. NUMBER	DATE			

DEXTER  
ROUTE 7  
CROSS SECTIONS

SHEET NUMBER  
**93**  
OF 15

Date: 5/19/2014

Username: Alee, Mousseau

Division: HIGHWAY

Filename: ... \094\_XSECT\_59+50\_061.dgn

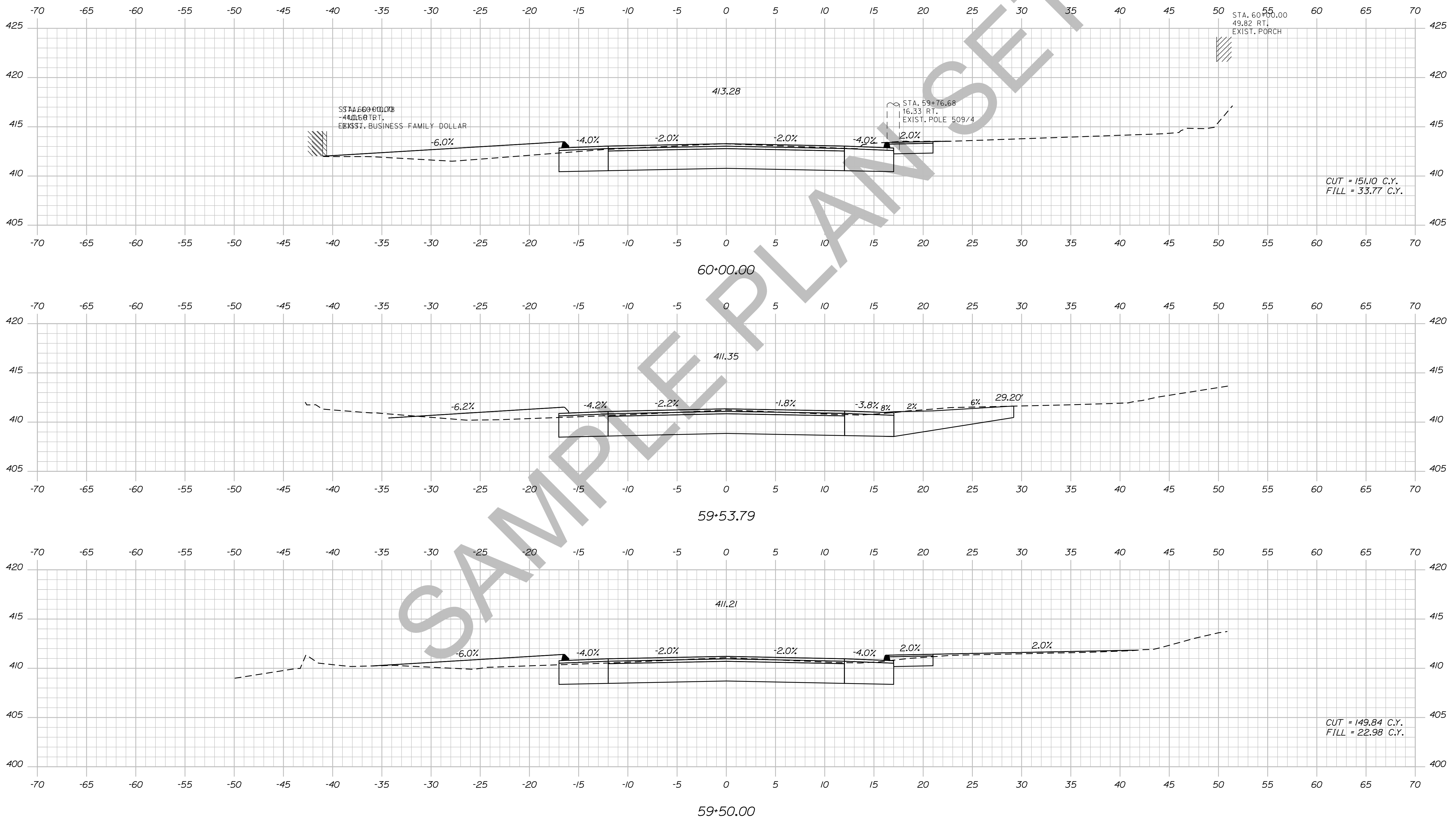

STATE OF MAINE  
 DEPARTMENT OF TRANSPORTATION  
 018246.00  
 PIN 18246.00  
 HIGHWAY PLANS

SIGNATURE  
 P.E. NUMBER  
 DATE

PROJ. MANAGER	BY	DATE
ERNEST MARTIN	TRAVIS WEL	
DESIGN-DETAILED		
CHECKED-REVIEWED		
DESIGN-DETAILED		
DESIGN-DETAILED		
REVISIONS 1		
REVISIONS 2		
REVISIONS 3		
REVISIONS 4		
FIELD CHANGES		

DEXTER  
 ROUTE 7  
 CROSS SECTIONS

SHEET NUMBER  
 94  
 OF 15

Date: 5/19/2014

Username: Alee.Mousseau

Division: HIGHWAY

Filename: ... \095\_XSECT\_60+08\_062.dgn

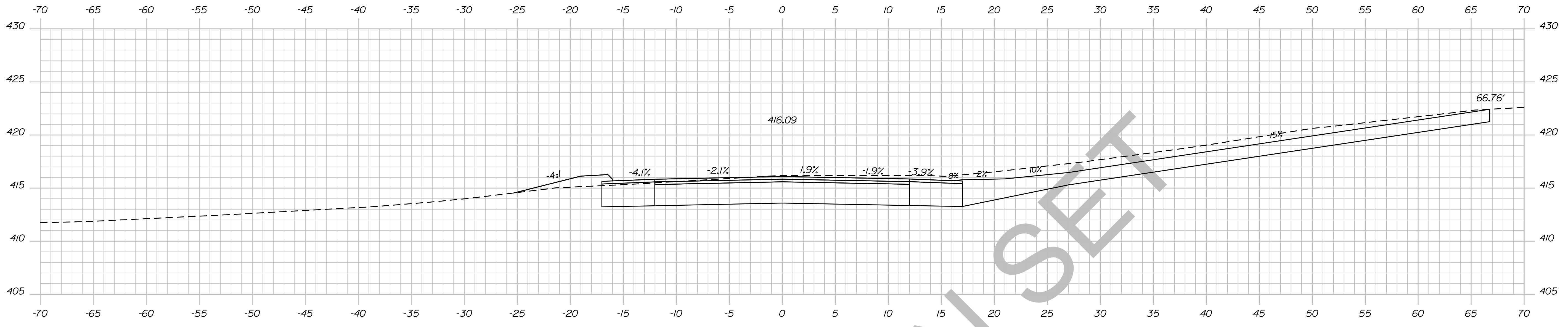

60+67.02

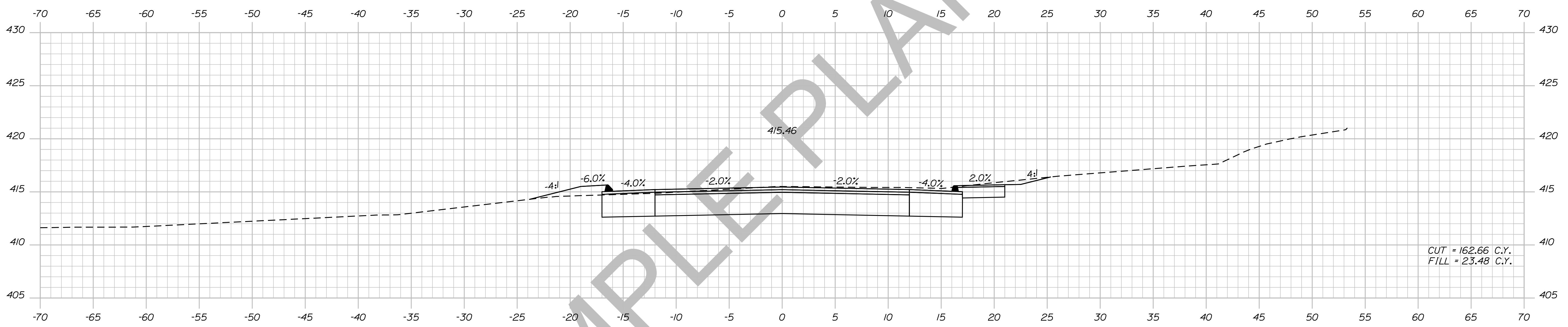

60+50.00

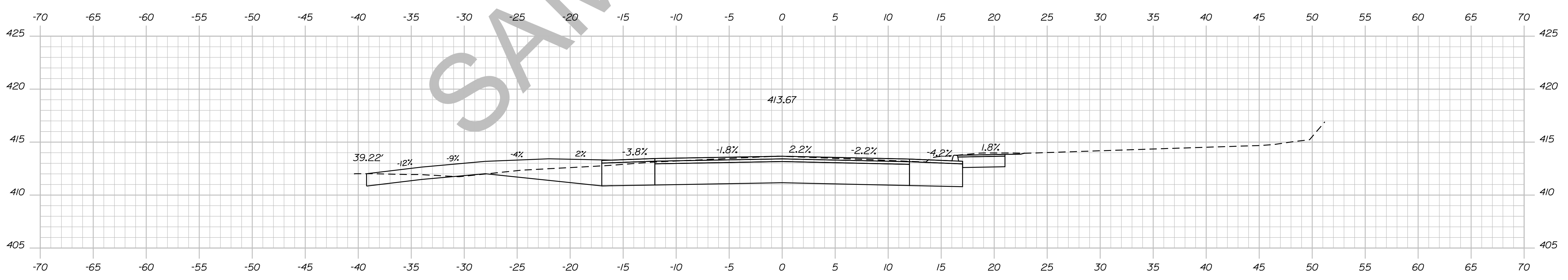

60+08.41

STATE OF MAINE  
DEPARTMENT OF TRANSPORTATION  
018246.00  
PIN  
18246.00  
HIGHWAY PLANS

DESIGN/REVISION	DATE	BY	SIGNATURE	P.E. NUMBER	DATE
DESIGN DETAILED		ERNEST MARTIN			
CHECKED/REVIEWED		TRAVIS WEL			
DESIGN DETAILED					
REVISIONS 1					
REVISIONS 2					
REVISIONS 3					
REVISIONS 4					
FIELD CHANGES					

DEXTER  
ROUTE 7  
CROSS SECTIONS

SHEET NUMBER  
**95**  
OF 15

Date: 5/19/2014

Username: Ailee.Mousseau

Division: HIGHWAY

Filename: ... \096\_XSECT\_61+00\_063.dgn

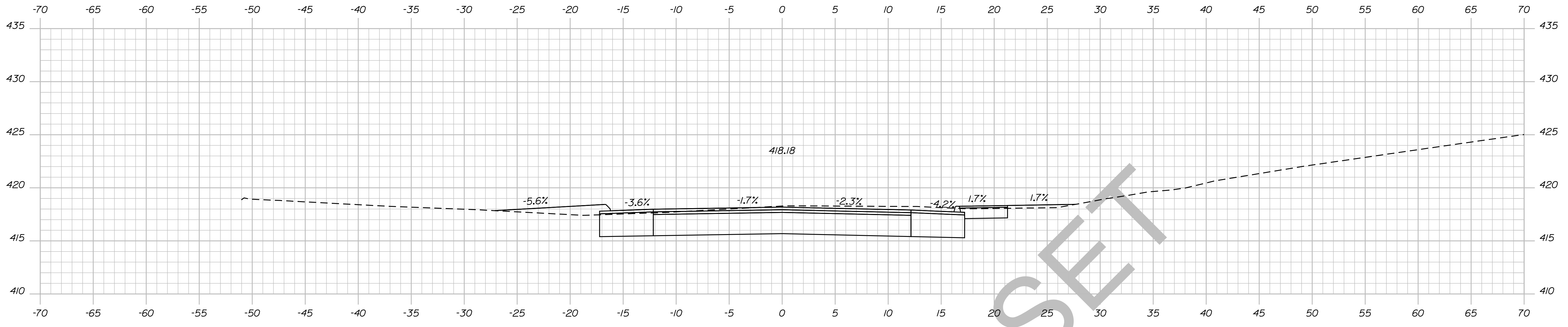

61+43.97

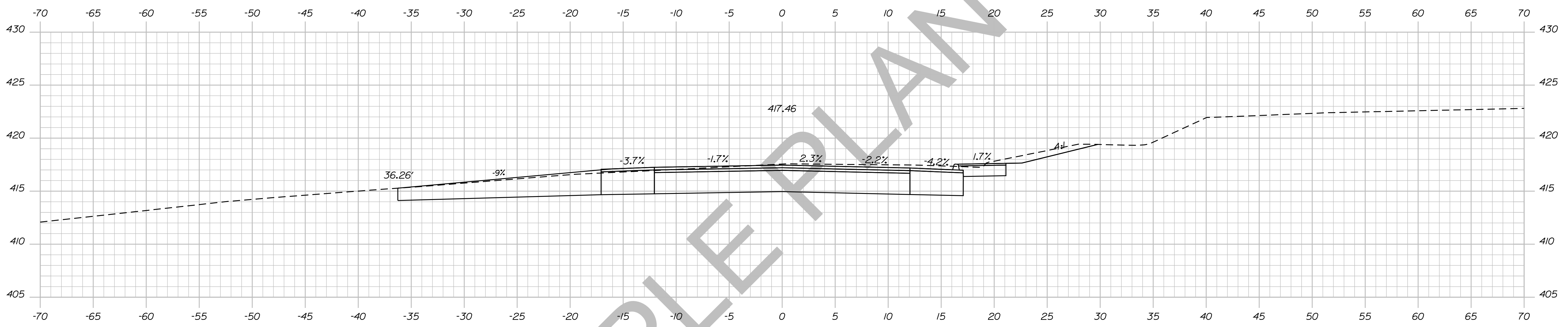

61+12.06

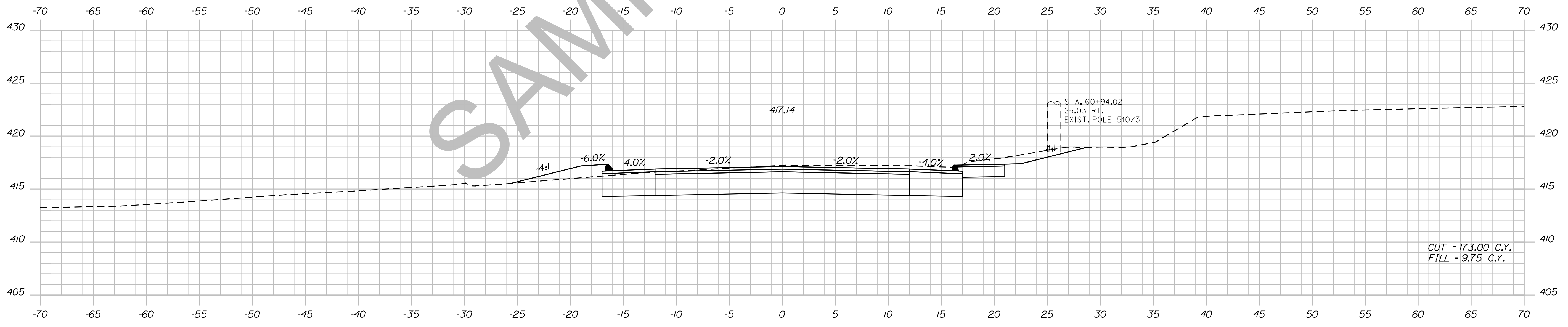

61+00.00

CUT = 173.00 C.Y.  
FILL = 9.75 C.Y.

STATE OF MAINE  
DEPARTMENT OF TRANSPORTATION  
018246.00  
PIN  
18246.00  
HIGHWAY PLANS

DESIGN-DETAILED	CHECKED-REVIEWED	DESIGN-DETAILED	DESIGN-DETAILED	REVISIONS 1	REVISIONS 2	REVISIONS 3	REVISIONS 4	FIELD CHANGES
TRAVIS WEL								
SIGNATURE								
P.E. NUMBER								
DATE								

DEXTER  
ROUTE 7  
CROSS SECTIONS

SHEET NUMBER  
**96**  
OF 15

Date: 5/19/2014

Username: Alee.Mousseau

Division: HIGHWAY

Filename: ... \097\_XSECT\_61+50\_064.dgn

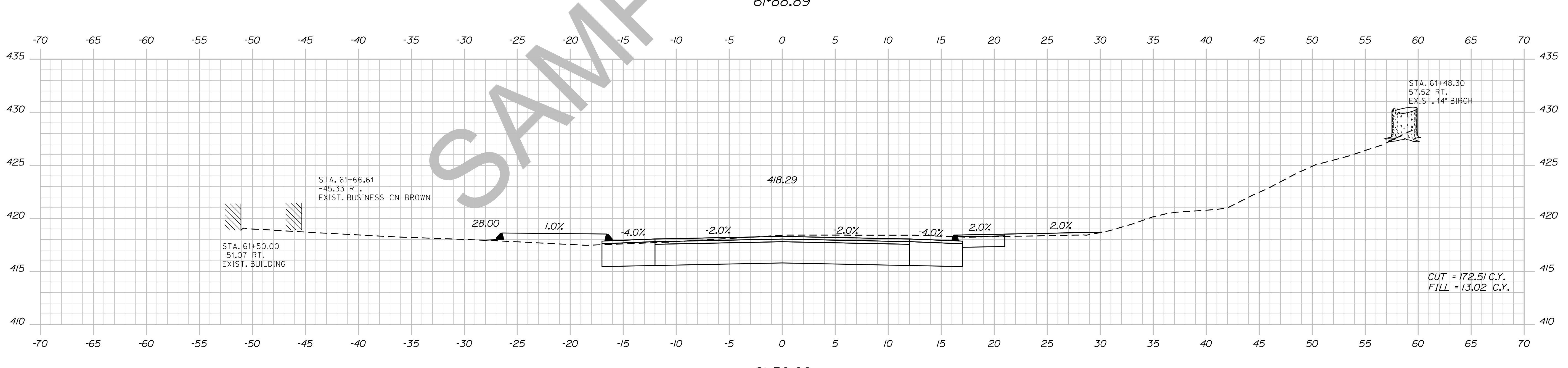
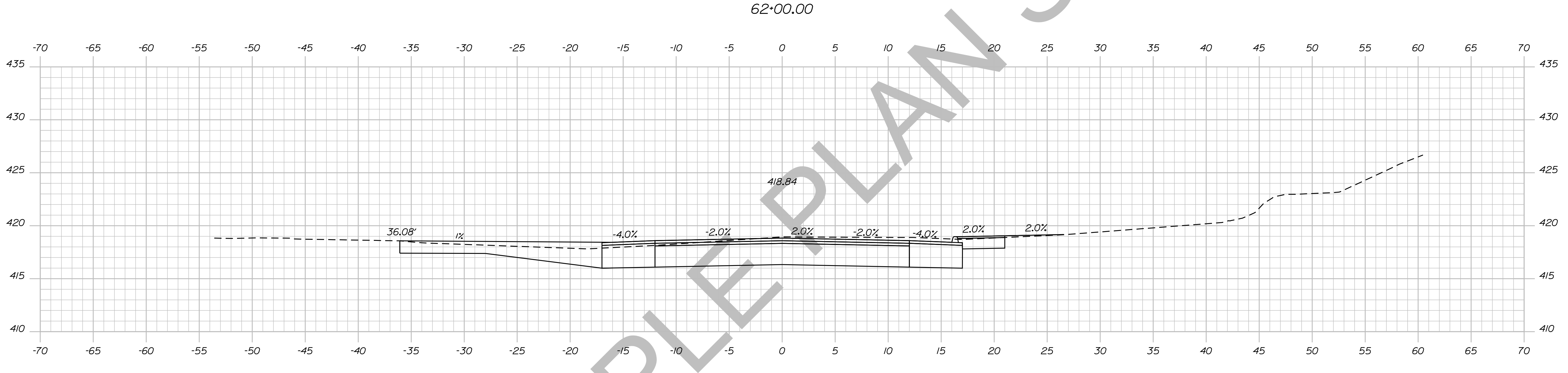
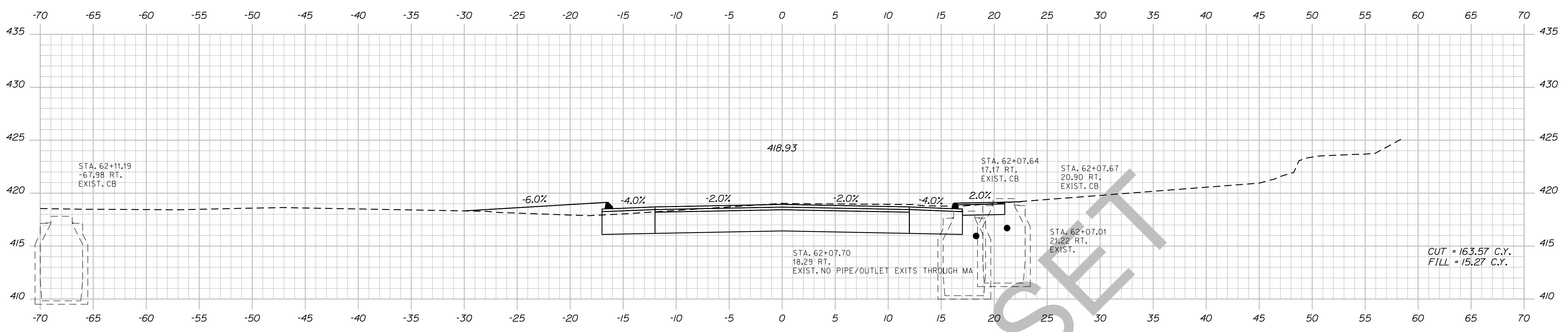

STATE OF MAINE		DEPARTMENT OF TRANSPORTATION		018246.00		PIN		18246.00		HIGHWAY PLANS	
DESIGN-DETAILED		CHECKED-REVIEWED		DESIGN-DETAILED		REVISIONS 1		REVISIONS 2		REVISIONS 3	
BY		DATE		SIGNATURE		P.E. NUMBER		DATE		FIELD CHANGES	
PROJ. MANAGER ERNEST MARTIN		TRAVIS WOLFE									
DEXTER ROUTE 7						CROSS SECTIONS					
SHEET NUMBER						97					
						OF 15					

Sta. 61+50.00 to Sta. 62+00.00



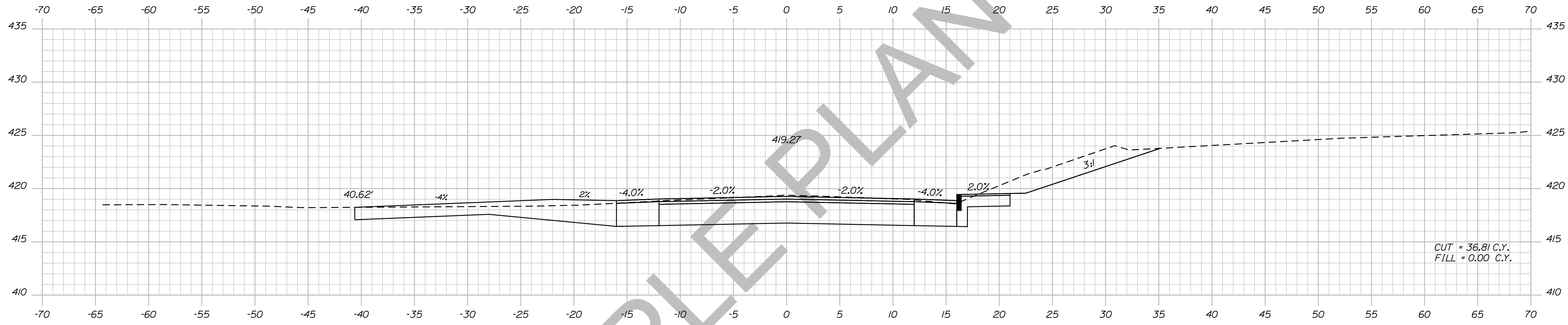

62+59.33

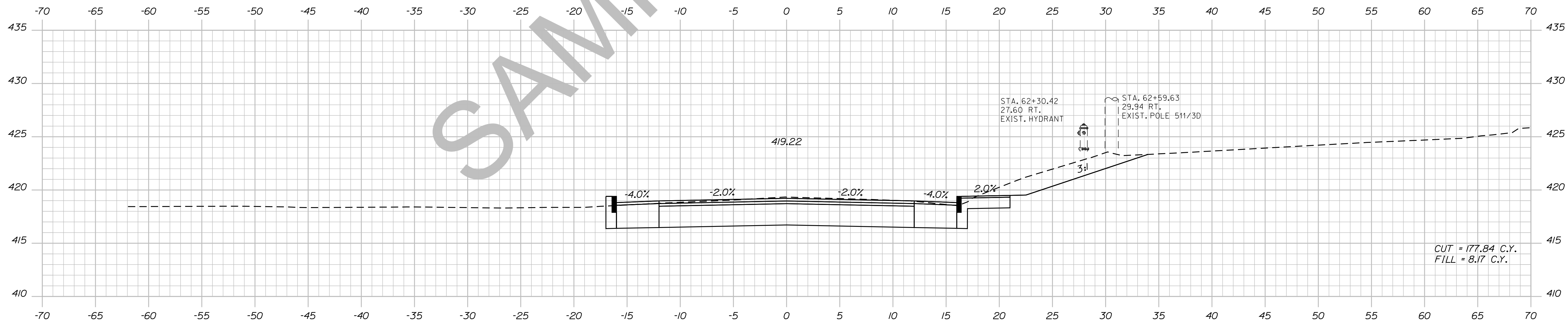

62+50.00

SAMPLE PLAN SET

STATE OF MAINE  
DEPARTMENT OF TRANSPORTATION  
018246-00  
PIN  
18246.00  
HIGHWAY PLANS

PROJ. MANAGER	ERNEST MARTIN	BY	DATE
DESIGN-DETAILED	TRAVIS WEL		
CHECKED-REVIEWED			
DESIGN-DETAILED			
REVISIONS 1			
REVISIONS 2			
REVISIONS 3			
REVISIONS 4			
FIELD CHANGES			

DEXTER  
ROUTE 7  
CROSS SECTIONS

SHEET NUMBER  
**98**  
OF 15

Date: 5/19/2014

Username: Alee.Mousseau

Division: HIGHWAY

Filename: ... \099\_XSECT\_63+00\_066.dgn

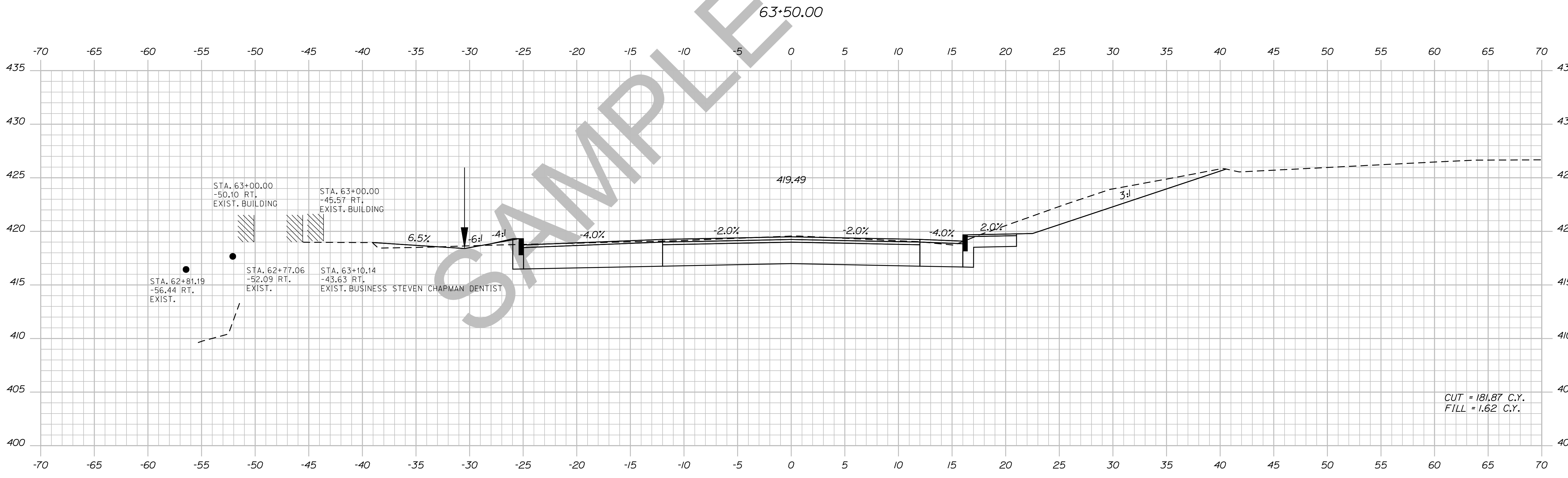
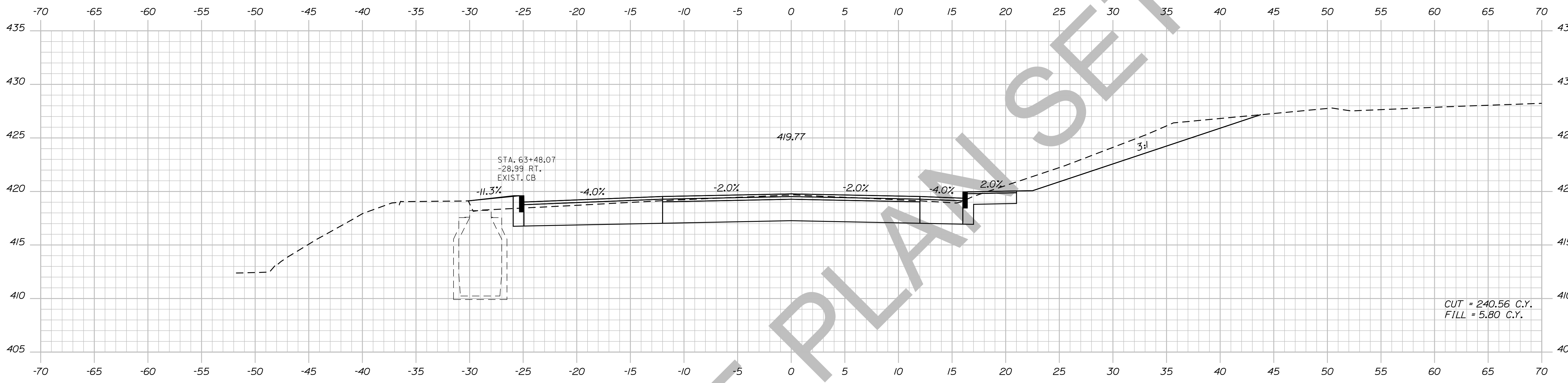

STATE OF MAINE  
DEPARTMENT OF TRANSPORTATION  
018246.00  
PIN 18246.00  
HIGHWAY PLANS

PROJ. MANAGER	ERNEST MARTIN	BY	DATE
CHECKED	TRAVIS WOLFE		
DESIGNED			
REVISIONS			
REVISIONS			
REVISIONS			
REVISIONS			
FIELD CHANGES			

DEXTER  
ROUTE 7  
CROSS SECTIONS

SHEET NUMBER  
**99**  
OF 15

Sta. 63+00.00 to Sta. 63+50.00

Date: 5/19/2014

Username: Ailee.Mousseau

Division: HIGHWAY

Filename: ... \100\_XSECT\_64+00\_067.dgn

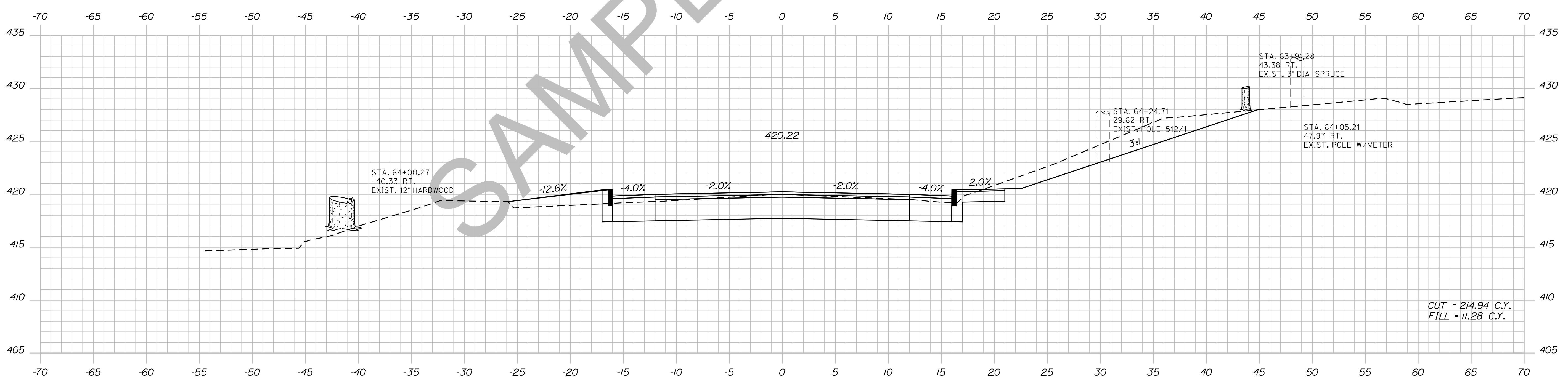
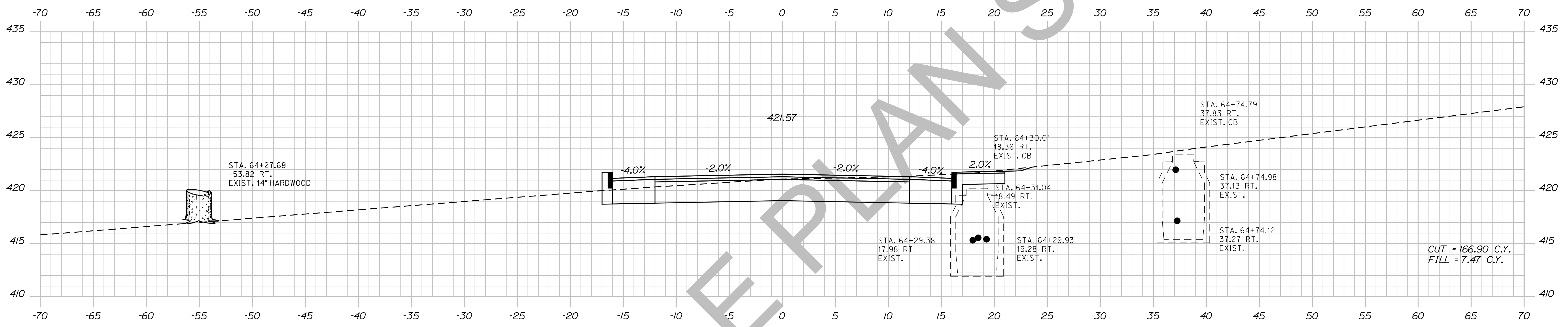

STATE OF MAINE  
DEPARTMENT OF TRANSPORTATION  
018246.00  
PIN  
18246.00  
HIGHWAY PLANS

PROJ. MANAGER	ERNEST MARTIN	DATE	SIGNATURE	P.E. NUMBER	DATE
DESIGN-DETAILED	TRAVIS WHEELER				
CHECKED-REVIEWED					
DESIGN-DETAILED					
REVISIONS 1					
REVISIONS 2					
REVISIONS 3					
REVISIONS 4					
FIELD CHANGES					

DEXTER  
ROUTE 7  
CROSS SECTIONS

SHEET NUMBER  
**100**  
OF 15

Date: 5/19/2014

Username: Allee.Mousseau

Division: HIGHWAY

Filename: ... \101\_XSECT\_65+00\_068.dgn

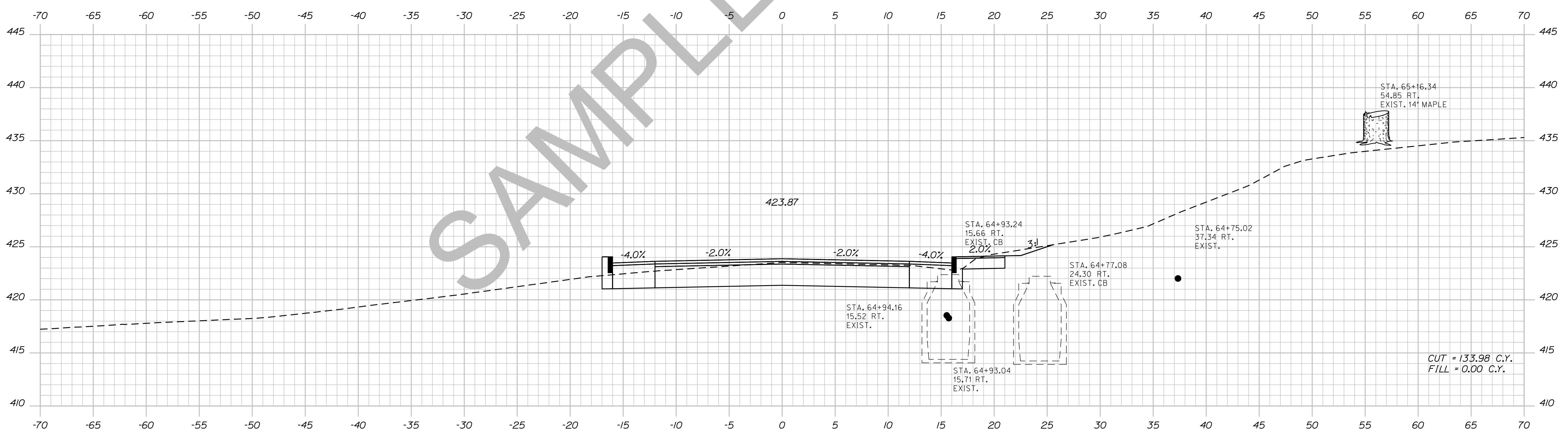
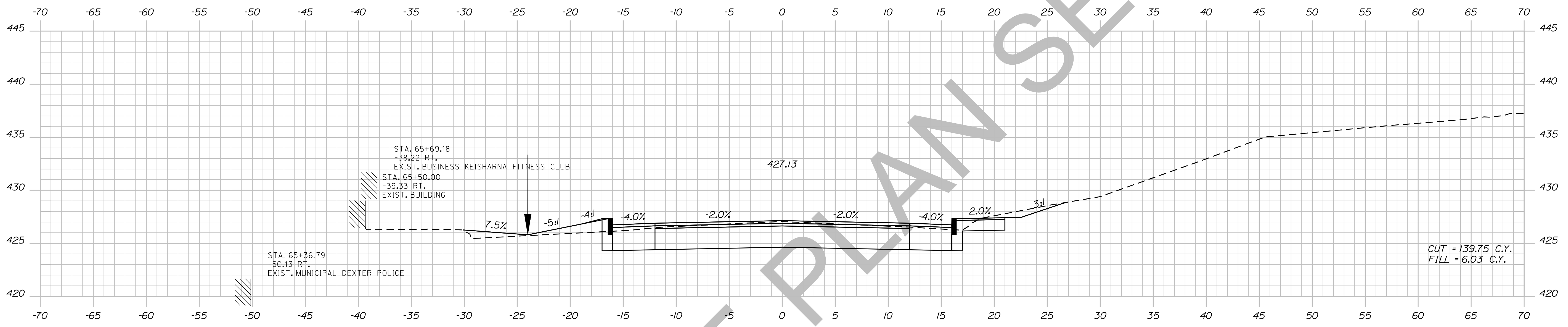

STATE OF MAINE  
DEPARTMENT OF TRANSPORTATION  
018246.00  
PIN  
18246.00  
HIGHWAY PLANS

DATE	SIGNATURE	P.E. NUMBER	DATE
PROJ. MANAGER ERNEST MARTIN			
CHECKED-REVIEWED TRAVIS WHEELER			
DESIGN DETAILED			
DESIGN REVIEWED			
DESIGN DETAILED			
DESIGN REVIEWED			
REVISIONS 1			
REVISIONS 2			
REVISIONS 3			
REVISIONS 4			
FIELD CHANGES			

DEXTER  
ROUTE 7  
CROSS SECTIONS

SHEET NUMBER  
**101**  
OF 15

Sta. 65+00.00 to Sta. 65+50.00

Date: 5/19/2014

Username: Alee.Mousseau

Division: HIGHWAY

Filename: ... \102\_XSECT\_66+00\_069.dgn

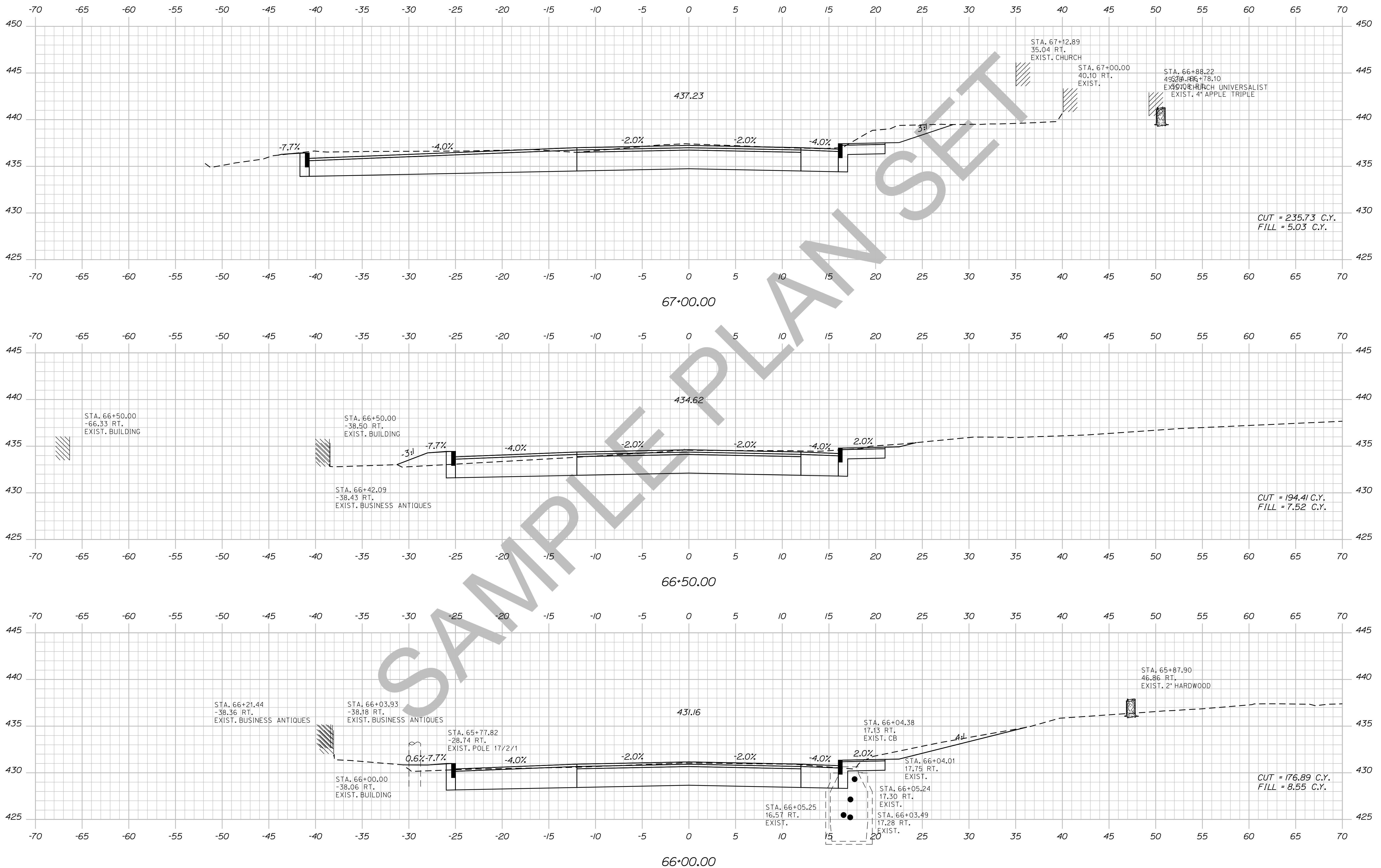

STATE OF MAINE  
 DEPARTMENT OF TRANSPORTATION  
 018246.00  
 PIN 18246.00  
 HIGHWAY PLANS

DESIGN-DETAILED	CHECKED-REVIEWED	DESIGNS DET AILED	REVISIONS 1	REVISIONS 2	REVISIONS 3	REVISIONS 4	FIELD CHANGES
TRAVIS WOLFE							

PROJ. MANAGER	BY	DATE	SIGNATURE	P.E. NUMBER	DATE
ERNEST MARTIN	TRAVIS WOLFE				

DEXTER  
 ROUTE 7  
 CROSS SECTIONS

SHEET NUMBER  
 102  
 OF 15

Date: 5/19/2014

Username: Allee.Mousseau

Division: HIGHWAY

Filename: ... \103\_XSECT\_67+50\_070.dgn

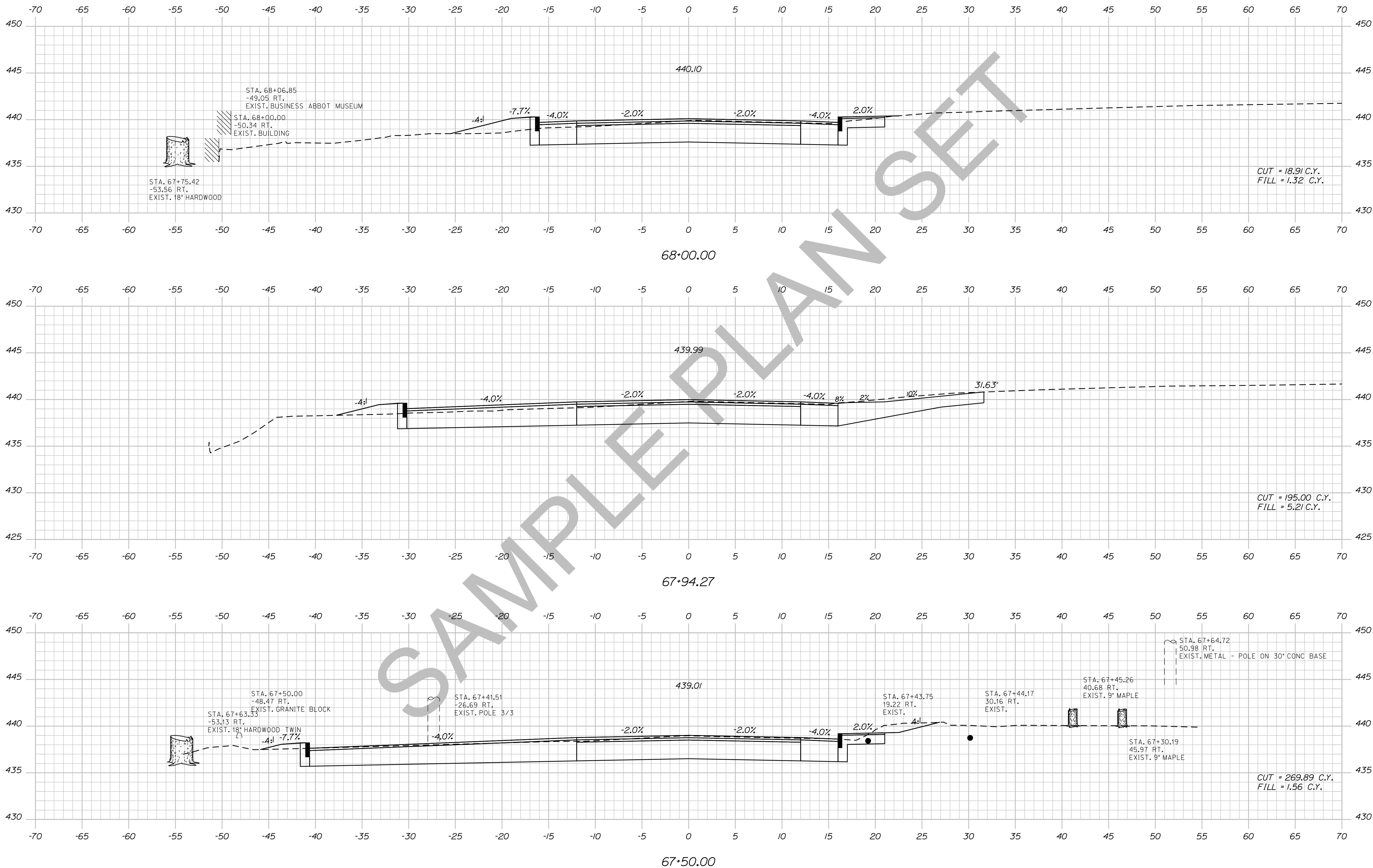

STATE OF MAINE DEPARTMENT OF TRANSPORTATION		018246.00	
		PIN 18246.00	
		HIGHWAY PLANS	
PROJ. MANAGER	ERNEST MARTIN	BY	TRAVIS WITEL
DESIGNED	TRAVIS WITEL	CHECKED	TRAVIS WITEL
DESIGNED	TRAVIS WITEL	DESIGNED	TRAVIS WITEL
REVISIONS 1		REVISIONS 1	
REVISIONS 2		REVISIONS 2	
REVISIONS 3		REVISIONS 3	
REVISIONS 4		REVISIONS 4	
FIELD CHANGES			
SIGNATURE		P.E. NUMBER	
DATE		DATE	
DEXTER ROUTE 7		CROSS SECTIONS	
SHEET NUMBER		103	
		OF 15	

Sta. 67+50.00 to Sta. 68+00.00



Date: 5/19/2014

Username: Alee.Mousseau

Division: HIGHWAY

Filename: ... \104\_XSECT\_68+50\_071.dgn

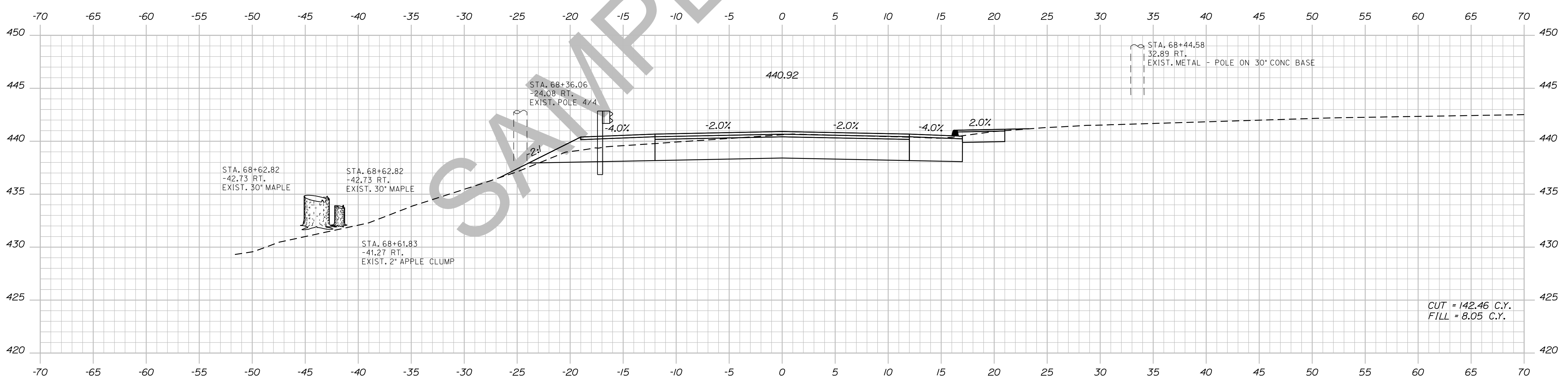
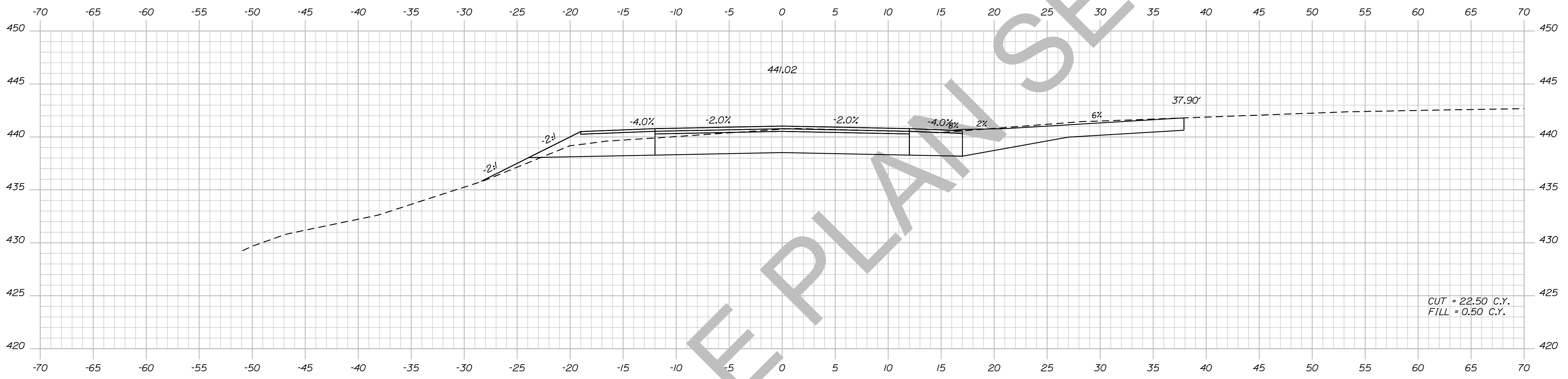

STATE OF MAINE  
DEPARTMENT OF TRANSPORTATION  
018246.00  
PIN  
18246.00  
HIGHWAY PLANS

PROJ. MGR	BY	DATE	SIGNATURE
ERNEST MARTIN	TRAVIS WEL		
DESIGN DETAILED			
CHECKED-REVIEWED			
DESIGN DETAILED			
DESIGN DETAILED			
REVISIONS 1			
REVISIONS 2			
REVISIONS 3			
REVISIONS 4			
FIELD CHANGES			

DEXTER  
ROUTE 7  
CROSS SECTIONS

SHEET NUMBER  
**104**  
OF 15

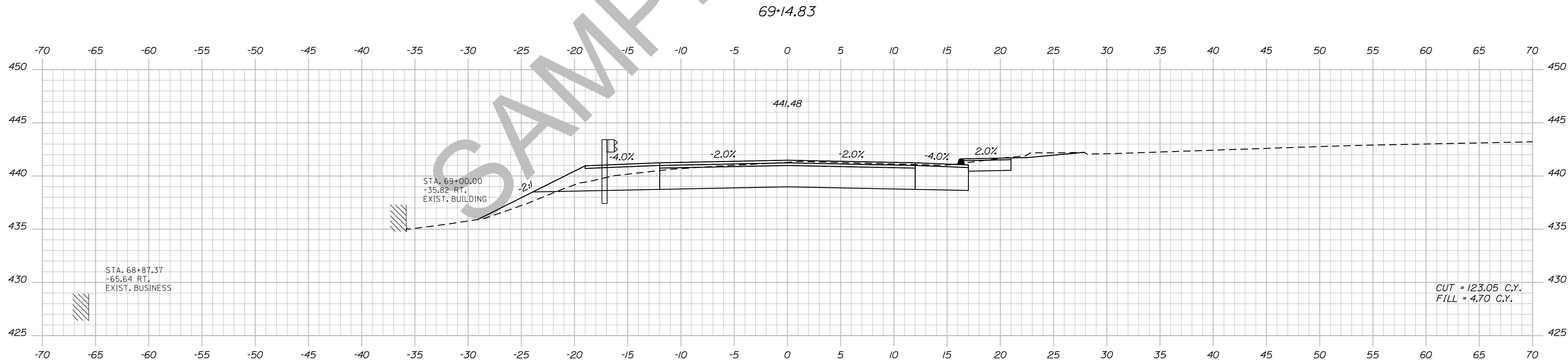
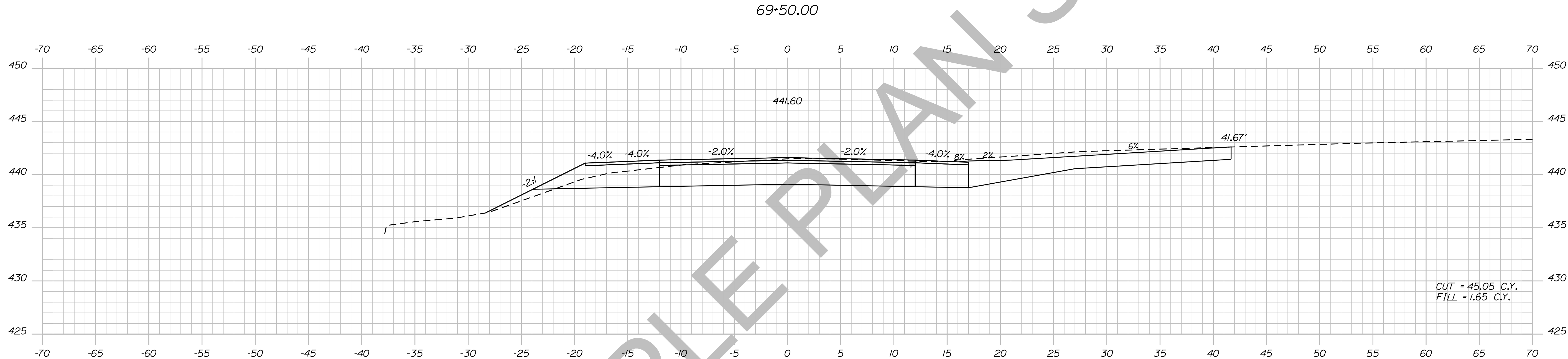
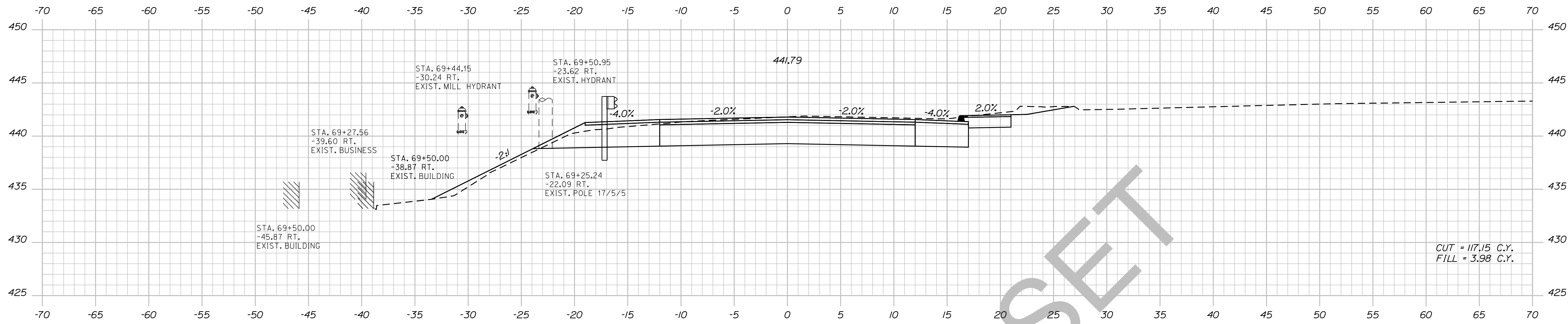

STATE OF MAINE  
DEPARTMENT OF TRANSPORTATION

018246.00  
PIN  
18246.00  
HIGHWAY PLANS

DESIGN/DETAILS	CHECKED/REVIEWED	DESIGNED/TAILED	DESIGNED/TAILED	REVISIONS 1	REVISIONS 2	REVISIONS 3	REVISIONS 4	FIELD CHANGES
TRAVIS WOLFE								

DEXTER  
ROUTE 7  
CROSS SECTIONS

SHEET NUMBER  
105  
OF 15

Date: 5/19/2014

Username: Alee.Mousseau

Division: HIGHWAY

Filename: ... \106\_XSECT\_69+75\_073.dgn

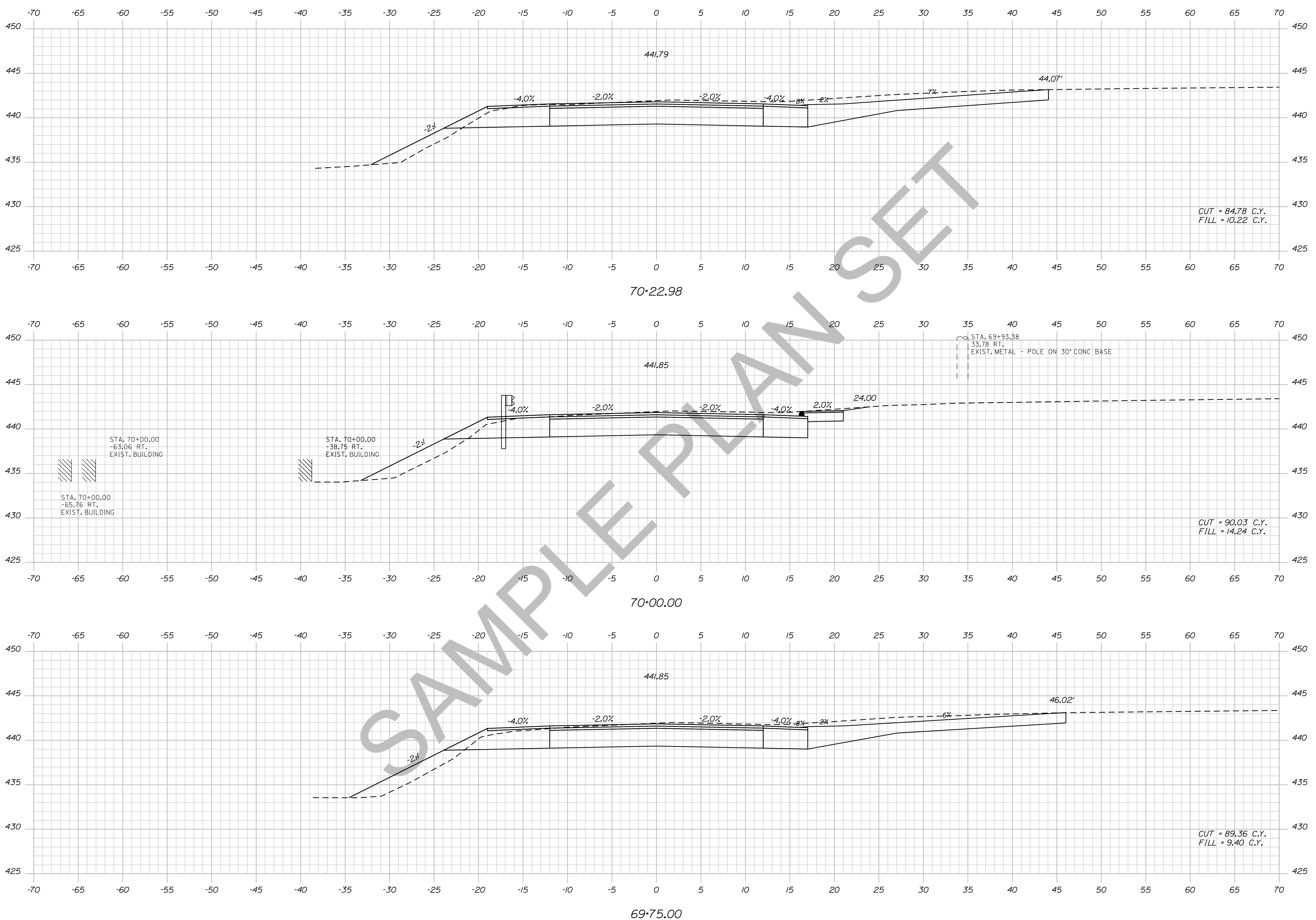

STATE OF MAINE  
DEPARTMENT OF TRANSPORTATION  
018246-00  
PIN 18246.00  
HIGHWAY PLANS

PROJ. MANAGER	ERNEST MARTIN	BY	DATE
DESIGN-DETAILED	TRAVIS WHEEL		
CHECKED-REVIEWED			
DESIGN-DETAILED			
REVISIONS 1			
REVISIONS 2			
REVISIONS 3			
REVISIONS 4			
FIELD CHANGES			

DEXTER  
ROUTE 7  
CROSS SECTIONS

SHEET NUMBER  
**106**  
OF 15

Date: 5/19/2014

Username: Alee.Mousseau

Division: HIGHWAY

Filename: ... \107\_XSECT\_70+50\_074.dgn

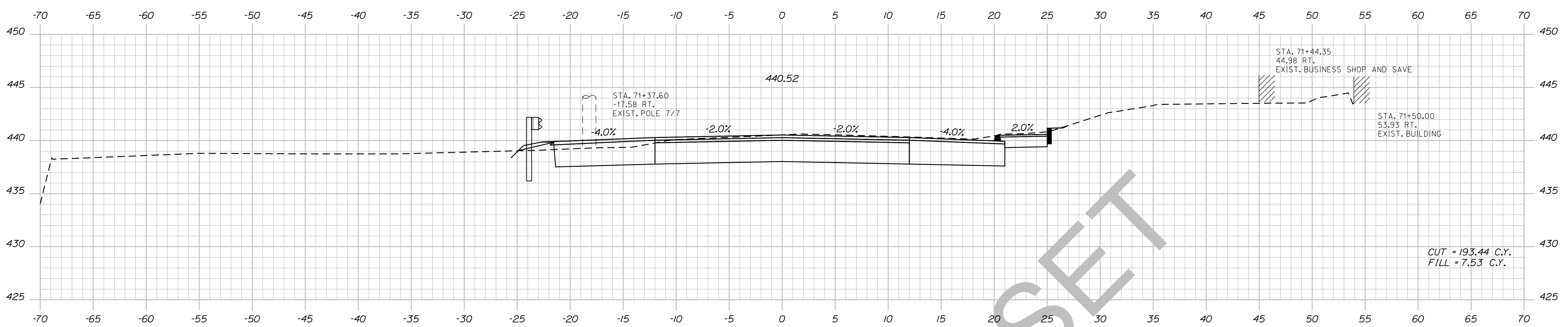

71+50.00

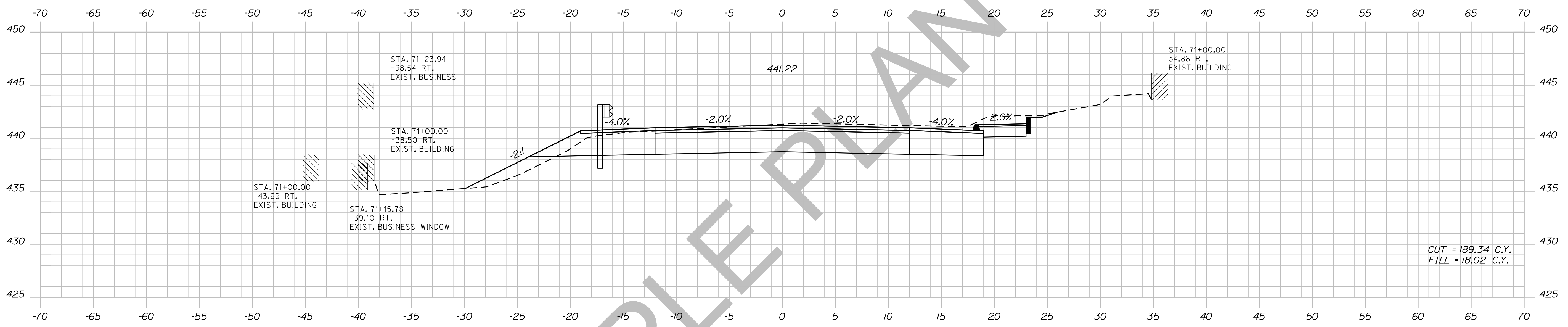

71+00.00

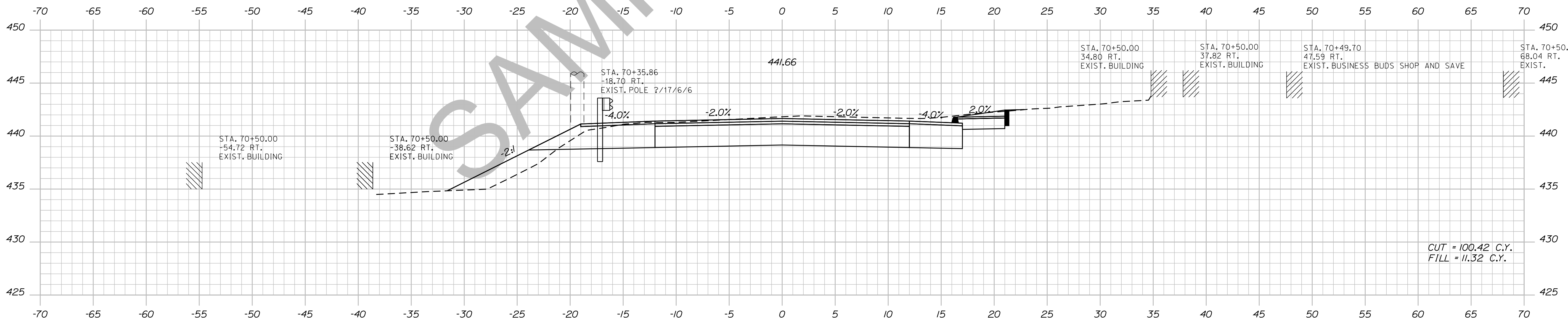

70+50.00

STATE OF MAINE  
DEPARTMENT OF TRANSPORTATION  
018246.00  
PIN 18246.00  
HIGHWAY PLANS

DESIGN-DETAILED	CHECKED-REVIEWED	DESIGN-DETAILED	DESIGN-DETAILED	REVISIONS 1	REVISIONS 2	REVISIONS 3	REVISIONS 4	FIELD CHANGES
TRAVIS WEL								
DATE	BY	PROJ. MANAGER	ERNEST MARTIN	SIGNATURE	P.E. NUMBER	DATE		

DEXTER  
ROUTE 7  
CROSS SECTIONS

SHEET NUMBER  
107  
OF 15

Sta. 70+50.00 to Sta. 71+50.00

Date: 5/19/2014

Username: Alee.Mousseau

Division: HIGHWAY

Filename: ... \108\_XSECT\_71+67\_075.dgn

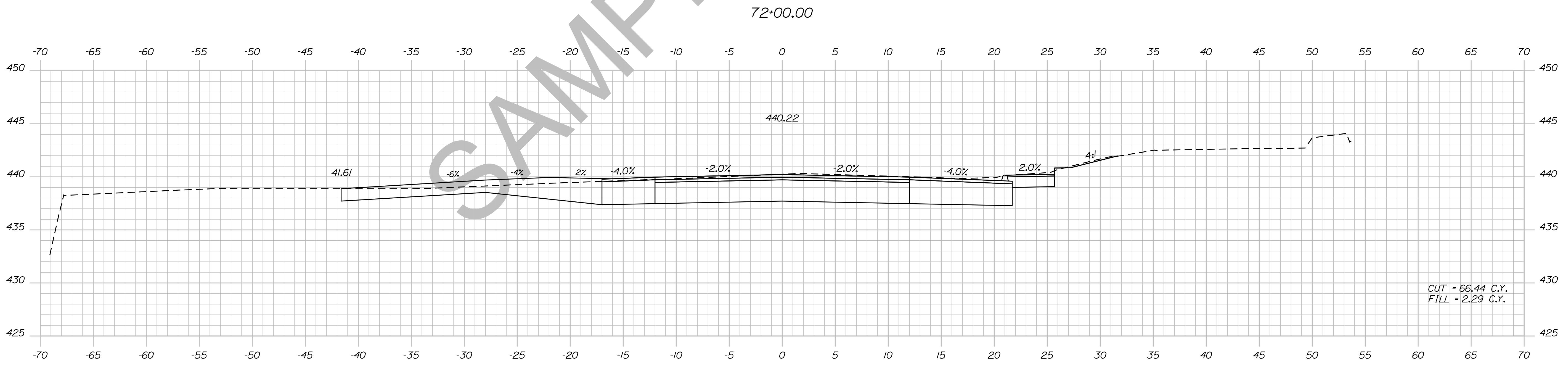
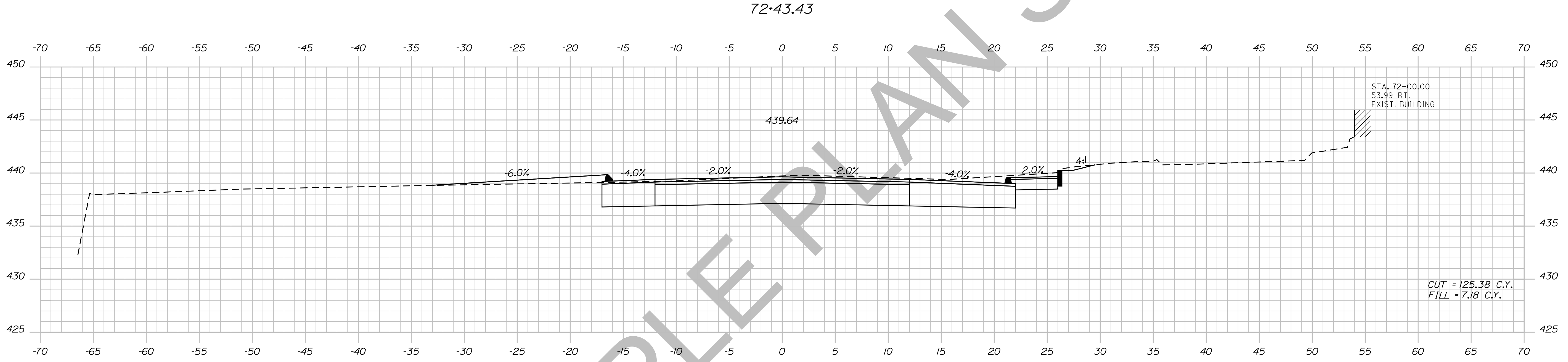
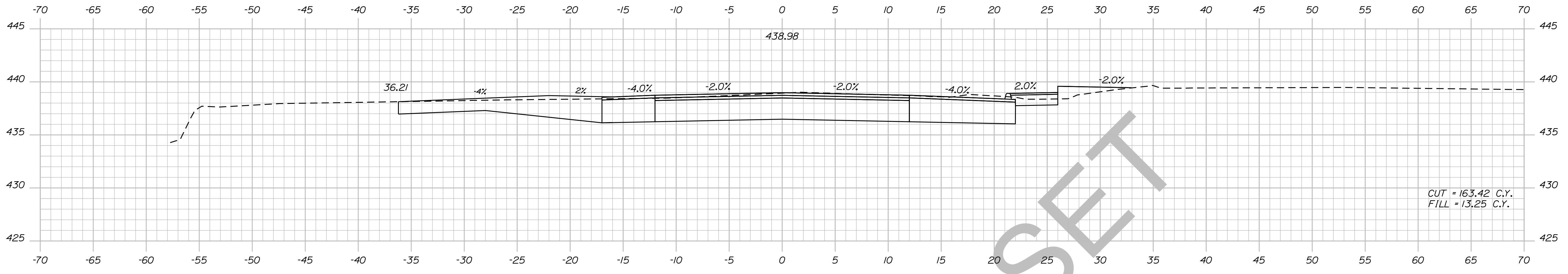

STATE OF MAINE  
DEPARTMENT OF TRANSPORTATION  
018246.00  
PIN 18246.00  
HIGHWAY PLANS

DESIGN-DETAILED	CHECKED-REVIEWED	DESIGN-DETAILED	DESIGN-DETAILED	REVISIONS 1	REVISIONS 2	REVISIONS 3	REVISIONS 4	FIELD CHANGES
TRAVIS WHEEL								
PROJ. MANAGER	ERNEST MARTIN	BY	DATE	SIGNATURE	P.E. NUMBER	DATE		

DEXTER  
ROUTE 7  
CROSS SECTIONS

SHEET NUMBER  
**108**  
OF 15

Date: 5/19/2014

Username: Alee.Mousseau

Division: HIGHWAY

Filename: ... \109\_XSECT\_72+50\_076.dgn

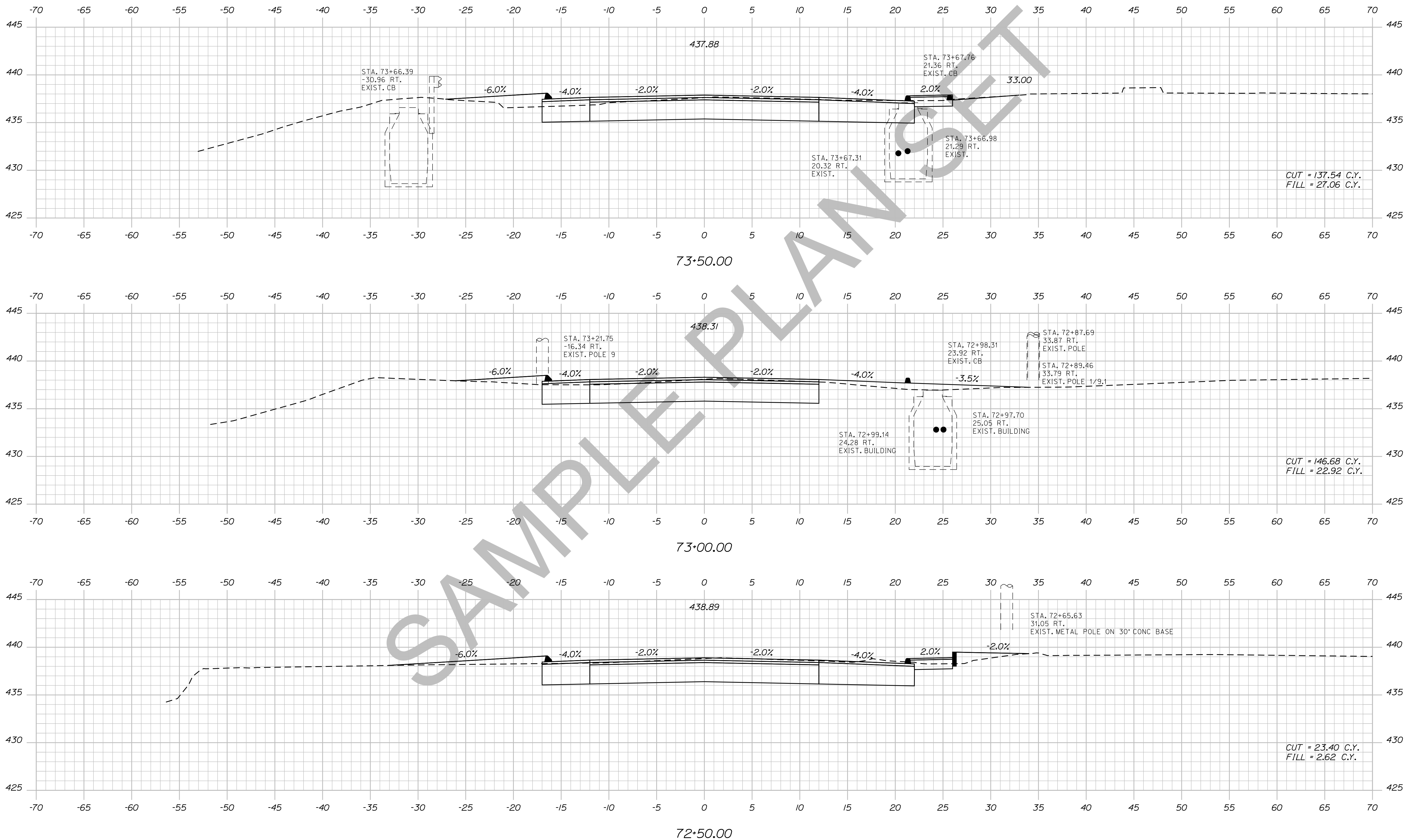

STATE OF MAINE  
 DEPARTMENT OF TRANSPORTATION  
 018246.00  
 PIN  
 18246.00  
 HIGHWAY PLANS

DATE	BY	PROJ. MANAGER	CHECKED	DESIGNED	REVISIONS	FIELD CHANGES
	TRAVIS WOLFE	ERNEST MARTIN	DETAILED	DETAILED	1	
			REVIEWED	REVIEWED	2	
			DESIGNED	DESIGNED	3	
			REVIEWED	REVIEWED	4	
			DESIGNED	DESIGNED		

DEXTER  
 ROUTE 7  
 CROSS SECTIONS

SHEET NUMBER  
**109**  
 OF 15



Username: Alee.Mousseau Date: 5/19/2014

Division: HIGHWAY

Filename: ... \110\_XSECT\_74+00\_077.dgn

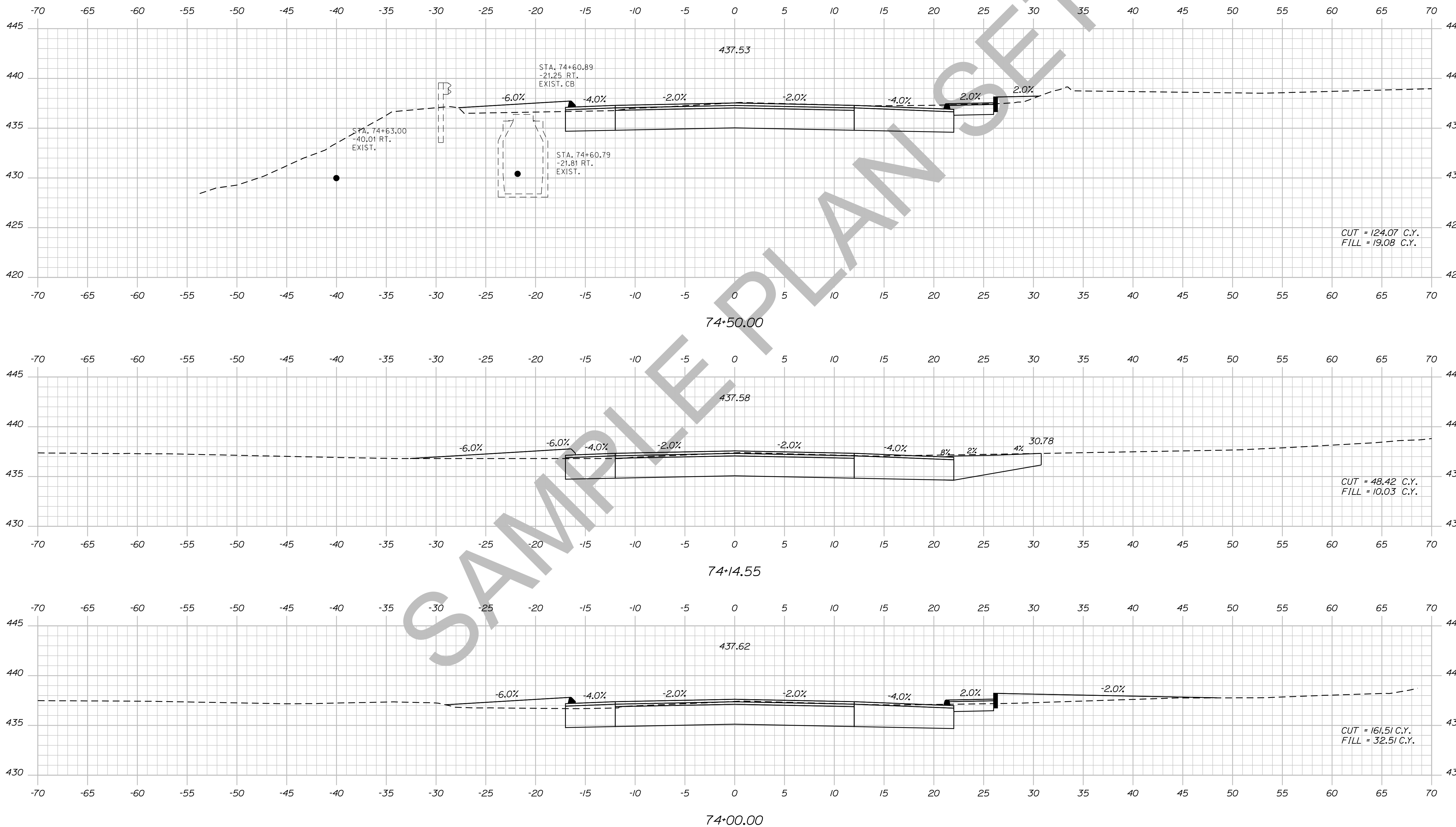

STATE OF MAINE  
DEPARTMENT OF TRANSPORTATION  
018246.00  
PIN 18246.00  
HIGHWAY PLANS

DATE	BY	SIGNATURE	P.E. NUMBER	DATE
	PROJ. MANAGER ERNEST MARTIN			
	CHECKED-REVIEWED TRAVIS WHEELER			
	DESIGNED-DETAILED			
	DESIGNED-DETAILED			
	REVISIONS 1			
	REVISIONS 2			
	REVISIONS 3			
	REVISIONS 4			
	FIELD CHANGES			

DEXTER  
ROUTE 7  
CROSS SECTIONS

SHEET NUMBER  
**110**  
OF 15

Date: 5/19/2014

Username: Alee.Mousseau

Division: HIGHWAY

Filename: ... \111\_XSECT\_75+00\_078.dgn

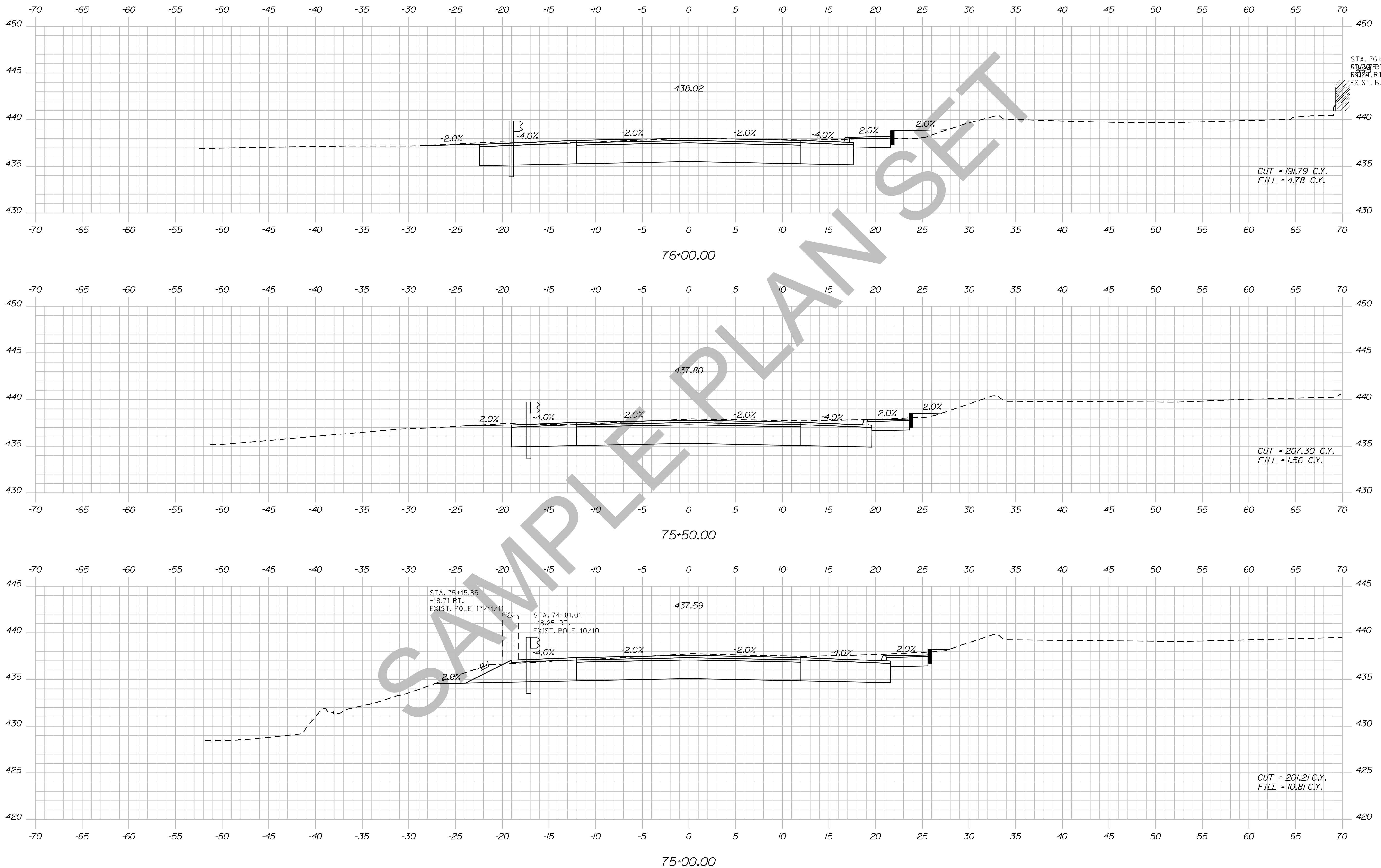

STATE OF MAINE  
 DEPARTMENT OF TRANSPORTATION  
 018246.00  
 PIN 18246.00  
 HIGHWAY PLANS

PROJ. MANAGER	ERNEST MARTIN	DATE
DESIGNED	TRAVIS WOLFE	
CHECKED		
DESIGNED		
DESIGNED		
REVISIONS		
REVISIONS		
REVISIONS		
REVISIONS		
FIELD CHANGES		

DEXTER  
 ROUTE 7  
 CROSS SECTIONS

SHEET NUMBER  
 111  
 OF 15

Date: 5/19/2014

Username: Ailee.Mousseau

Division: HIGHWAY

Filename: ... \112\_XSECT\_76+26\_079.dgn

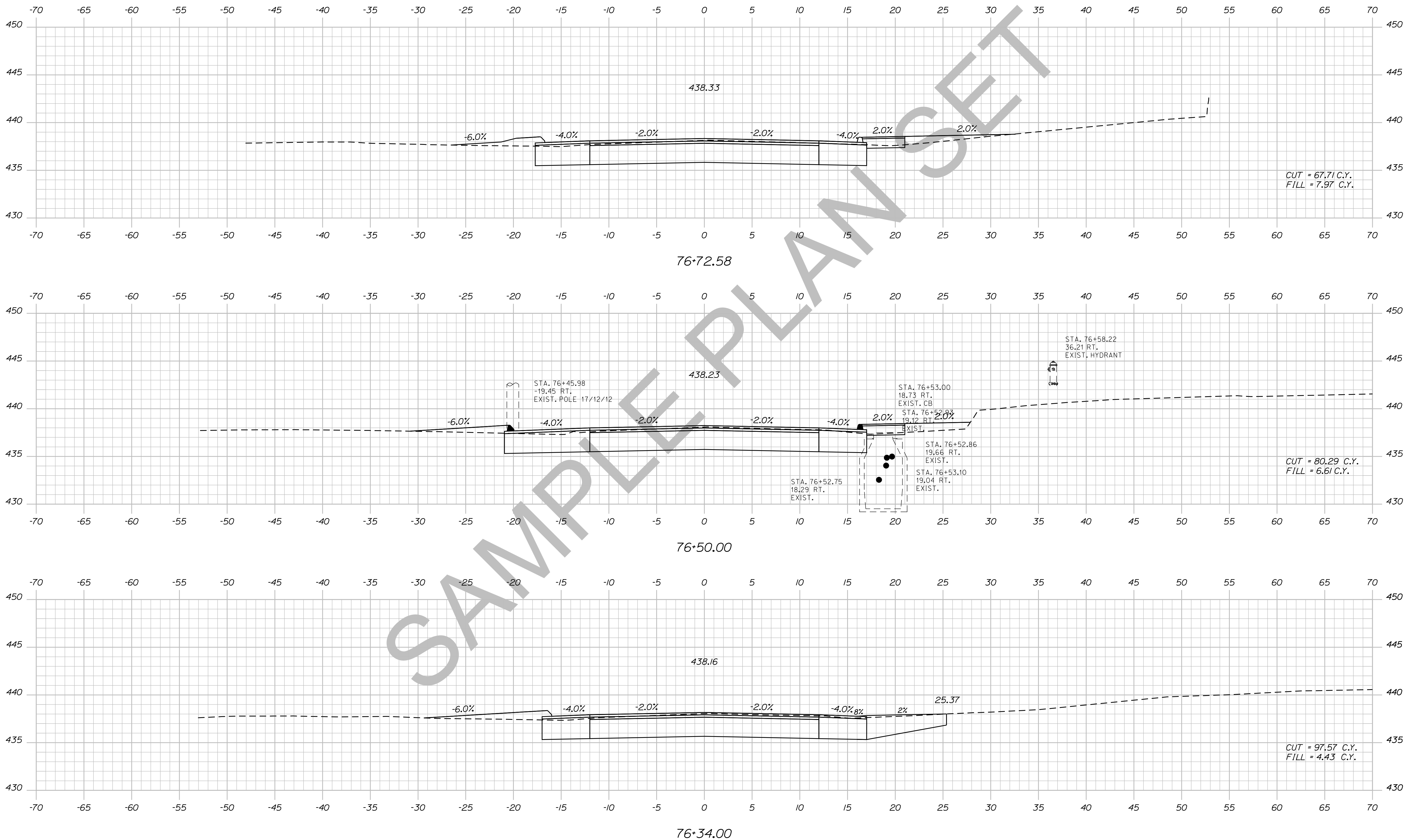

STATE OF MAINE  
DEPARTMENT OF TRANSPORTATION  
018246.00  
PIN 18246.00  
HIGHWAY PLANS

DATE	BY	PROJ. MANAGER	DESIGN-DETAILED	CHECKED-REVIEWED	DESIGN-DETAILED	DESIGN-DETAILED	REVISIONS 1	REVISIONS 2	REVISIONS 3	REVISIONS 4	FIELD CHANGES
		ERNEST MARTIN	TRAVIS WHEEL								

DEXTER  
ROUTE 7  
CROSS SECTIONS

SHEET NUMBER  
**112**  
OF 15

Date: 5/19/2014

Username: Alee.Mousseau

Division: HIGHWAY

Filename: ... \113\_XSECT\_76+90\_080.dgn

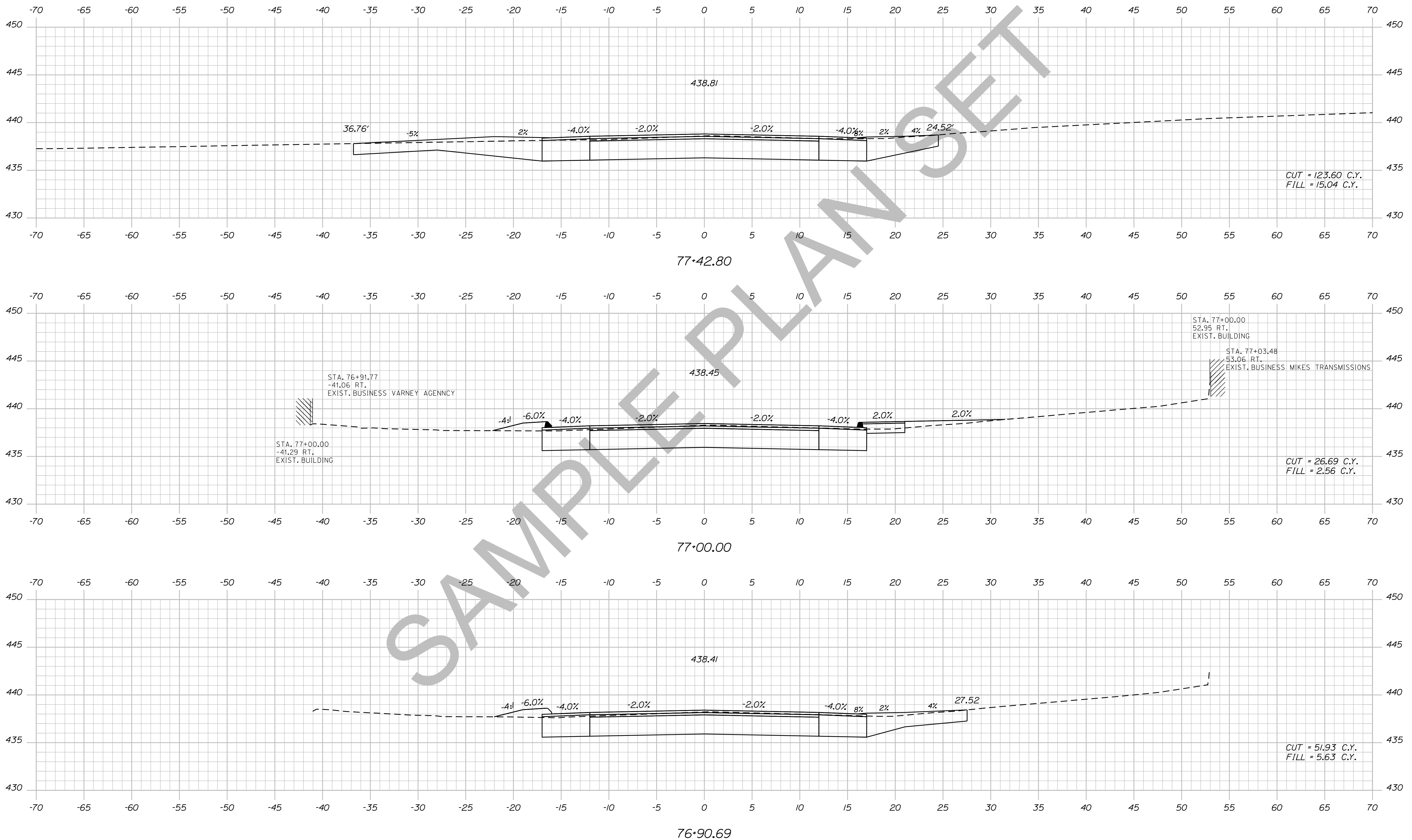

STATE OF MAINE  
DEPARTMENT OF TRANSPORTATION  
018246.00  
PIN  
18246.00  
HIGHWAY PLANS

DATE	BY	PROJ. MANAGER	CHECKED	DESIGNED	REVISIONS	FIELD CHANGES
	TRAVIS WOLFE	ERNEST MARTIN				
			DESIGN-DETAILED	DESIGN-DETAILED	REVISIONS 1	
			DESIGN-REVIEWED	DESIGN-REVIEWED	REVISIONS 2	
					REVISIONS 3	
					REVISIONS 4	

DEXTER  
ROUTE 7  
CROSS SECTIONS

SHEET NUMBER  
**113**  
OF 15

Date: 5/19/2014

Username: Alee.Mousseau

Division: HIGHWAY

Filename: ... \114\_XSECT\_77+50\_081.dgn

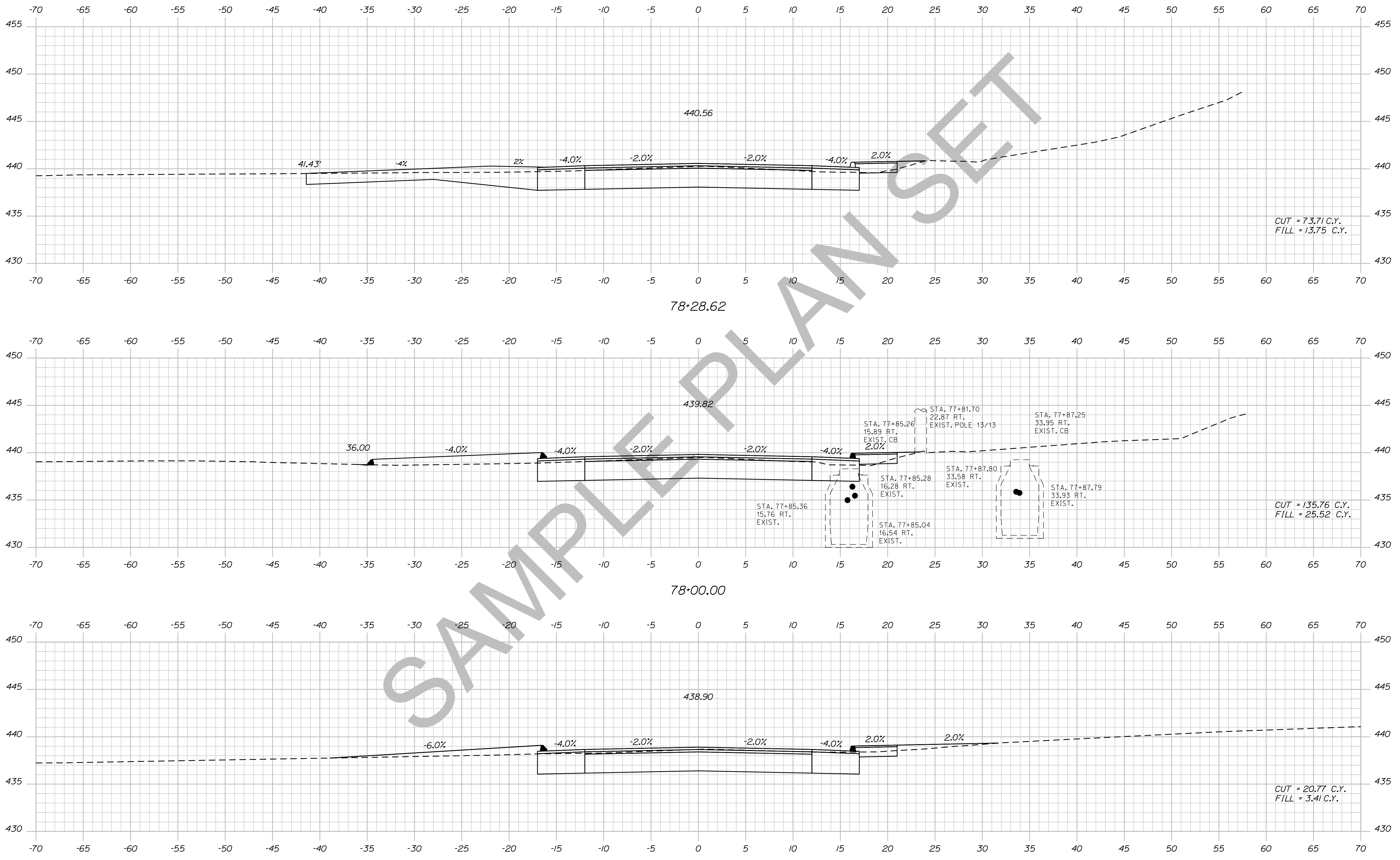

STATE OF MAINE  
 DEPARTMENT OF TRANSPORTATION  
 018246.00  
 PIN 18246.00  
 HIGHWAY PLANS

DATE	BY	PROJ. MANAGER	ERNEST MARTIN	TRAVIS WEL
		DESIGN DETAILED		
		CHECKED/REVIEWED		
		DESIGNS DETAILED		
		DESIGNS DETAILED		
		REVISIONS 1		
		REVISIONS 2		
		REVISIONS 3		
		REVISIONS 4		
		FIELD CHANGES		

DEXTER  
 ROUTE 7  
 CROSS SECTIONS

SHEET NUMBER  
 114  
 OF 15

Date: 5/19/2014

Username: Alee.Mousseau

Division: HIGHWAY

Filename: ... \115\_XSECT\_78+50\_082.dgn

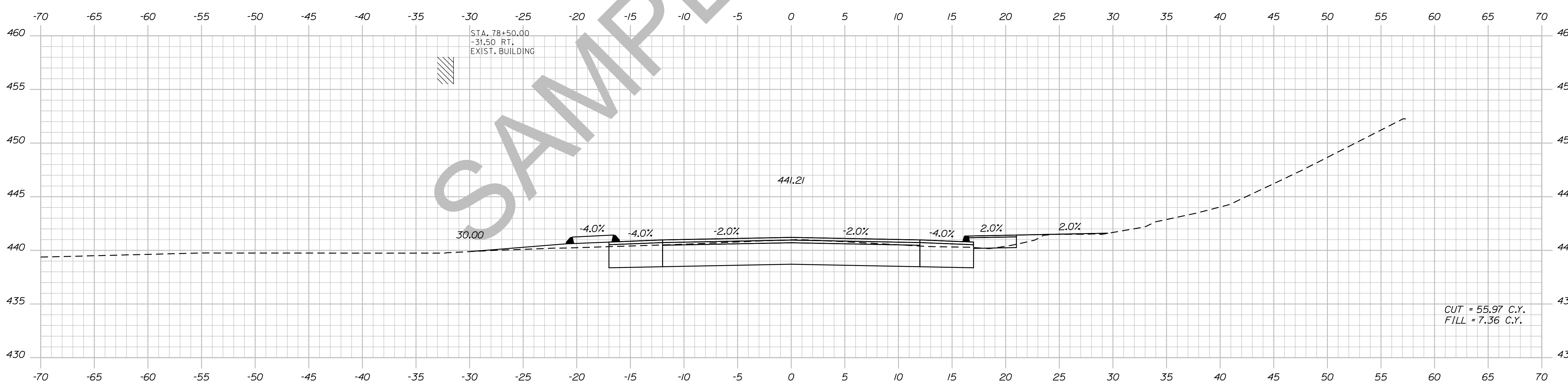
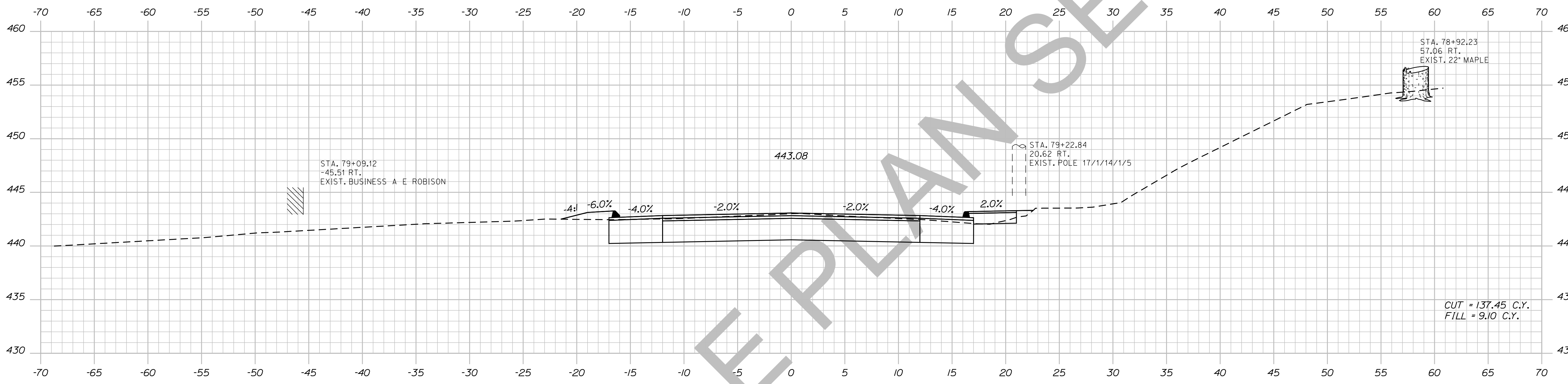

STATE OF MAINE  
DEPARTMENT OF TRANSPORTATION  
018246.00  
PIN  
18246.00  
HIGHWAY PLANS

SIGNATURE  
P.E. NUMBER  
DATE

PROJ. MANAGER	ERNEST MARTIN	BY	DATE
CHECKED-REVIEWED	TRAVIS WOLFE		
DESIGNS DET AILED			
REVISIONS 1			
REVISIONS 2			
REVISIONS 3			
REVISIONS 4			
FIELD CHANGES			

DEXTER  
ROUTE 7  
CROSS SECTIONS

SHEET NUMBER  
115  
OF 15

Sta. 78+50.00 to Sta. 79+00.00



Date: 5/19/2014

Username: Allee.Mousseau

Division: HIGHWAY

Filename: ... \116\_XSECT\_79+33\_083.dgn

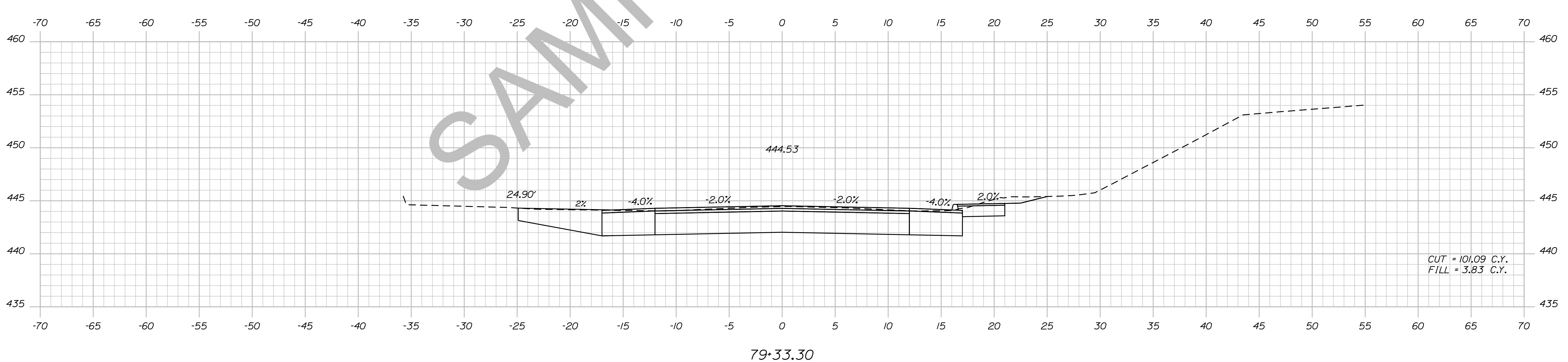
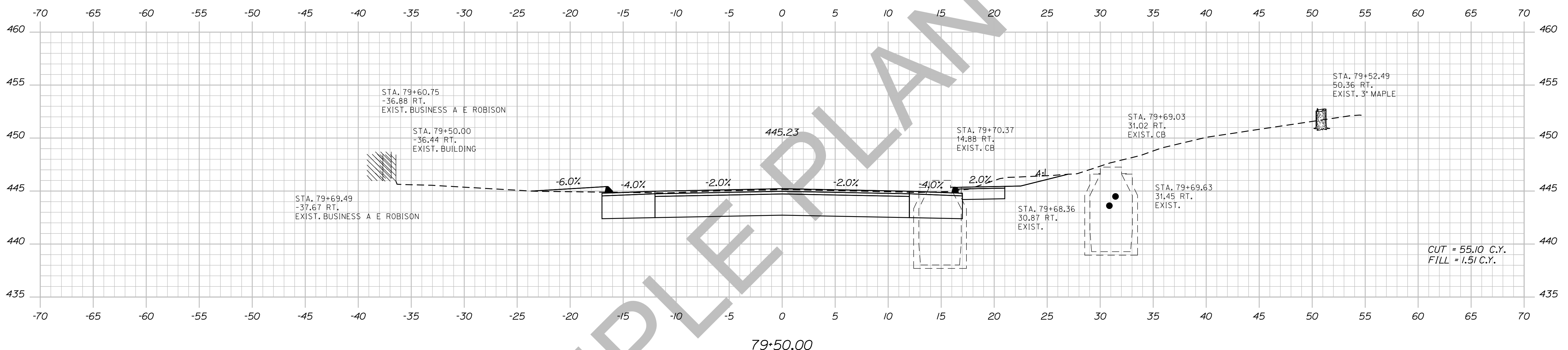
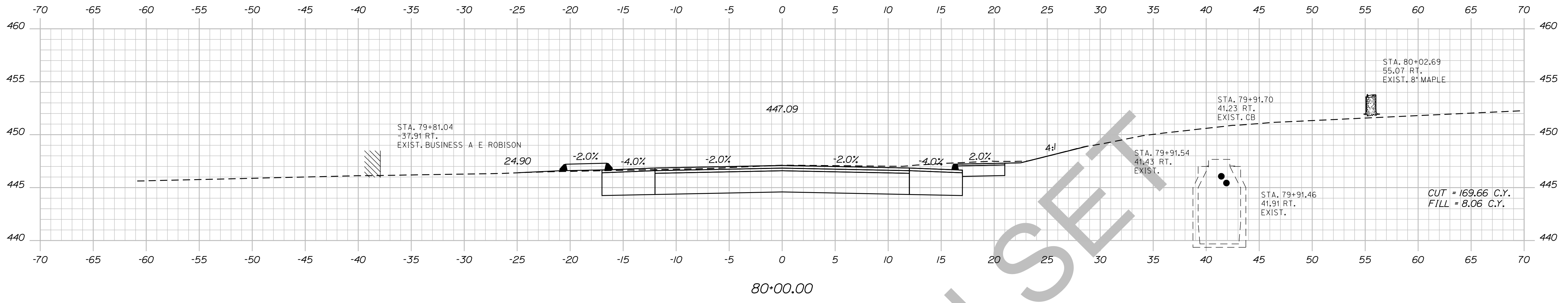

STATE OF MAINE  
 DEPARTMENT OF TRANSPORTATION  
 018246.00  
 PIN 18246.00  
 HIGHWAY PLANS

PROJ. MANAGER	BY	DATE	SIGNATURE	P.E. NUMBER	DATE
ERNEST MARTIN	TRAVIS WHEL				
DESIGN-DETAILED					
CHECKED-REVIEWED					
DESIGN-DETAILED					
DESIGN-DETAILED					
REVISIONS 1					
REVISIONS 2					
REVISIONS 3					
REVISIONS 4					
FIELD CHANGES					

DEXTER  
 ROUTE 7  
 CROSS SECTIONS

SHEET NUMBER  
 116  
 OF 15

Date: 5/19/2014

Username: Alee.Mousseau

Division: HIGHWAY

Filename: ... \117\_XSECT\_80+25\_084.dgn

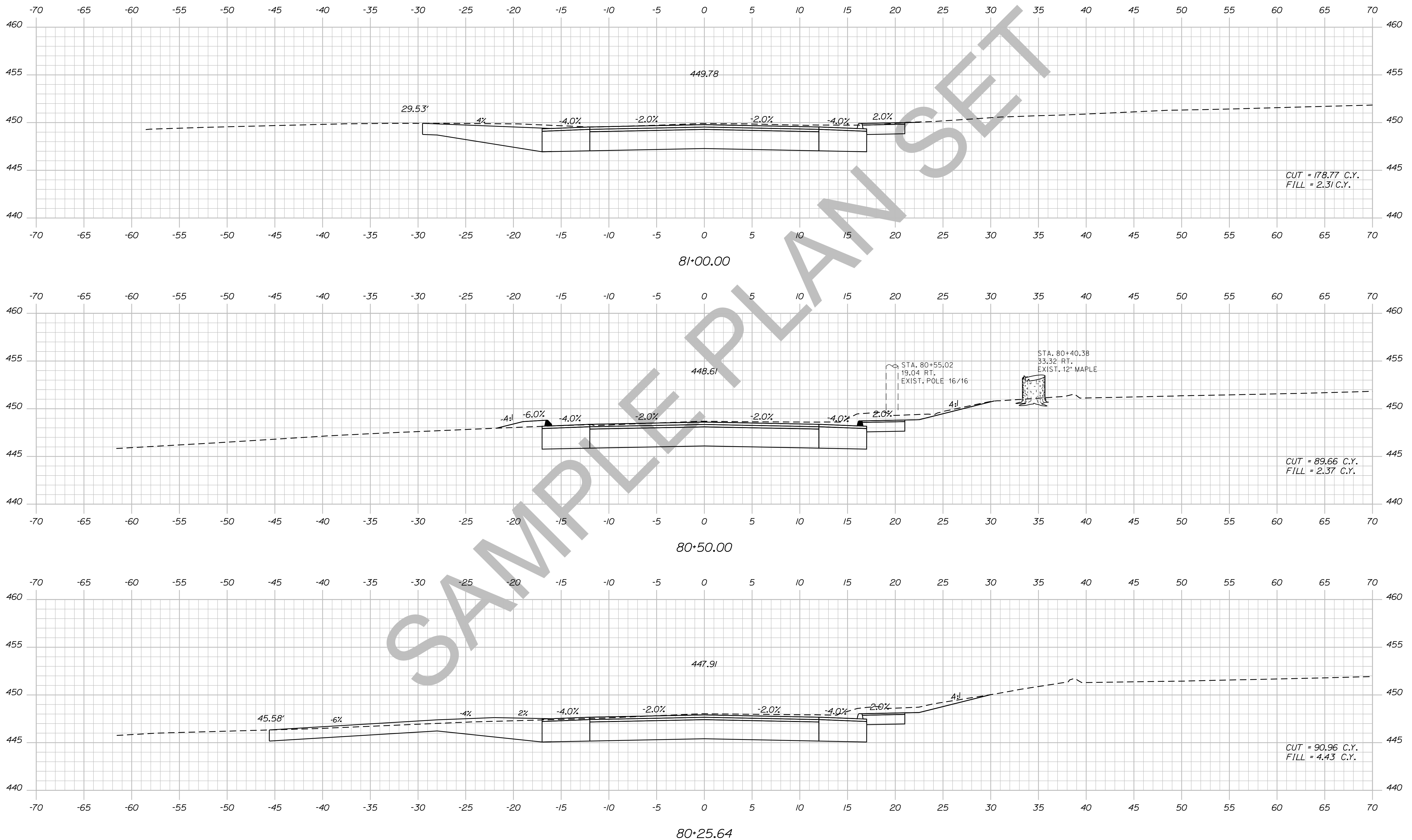

STATE OF MAINE  
DEPARTMENT OF TRANSPORTATION  
018246.00  
PIN  
18246.00  
HIGHWAY PLANS

DATE	BY	PROJ. MANAGER	CHECKED	DESIGNED	REVISIONS	FIELD CHANGES
	TRAVIS WOLFE	ERNEST MARTIN				
			DESIGN REVIEWED	DESIGN DETAILED	REVISIONS 1	
					REVISIONS 2	
					REVISIONS 3	
					REVISIONS 4	

SIGNATURE	P.E. NUMBER	DATE

DEXTER  
ROUTE 7  
CROSS SECTIONS

SHEET NUMBER  
**117**  
OF 15

Date: 5/19/2014

Username: Alee.Mousseau

Division: HIGHWAY

Filename: ... \118\_XSECT\_81+05\_085.dgn

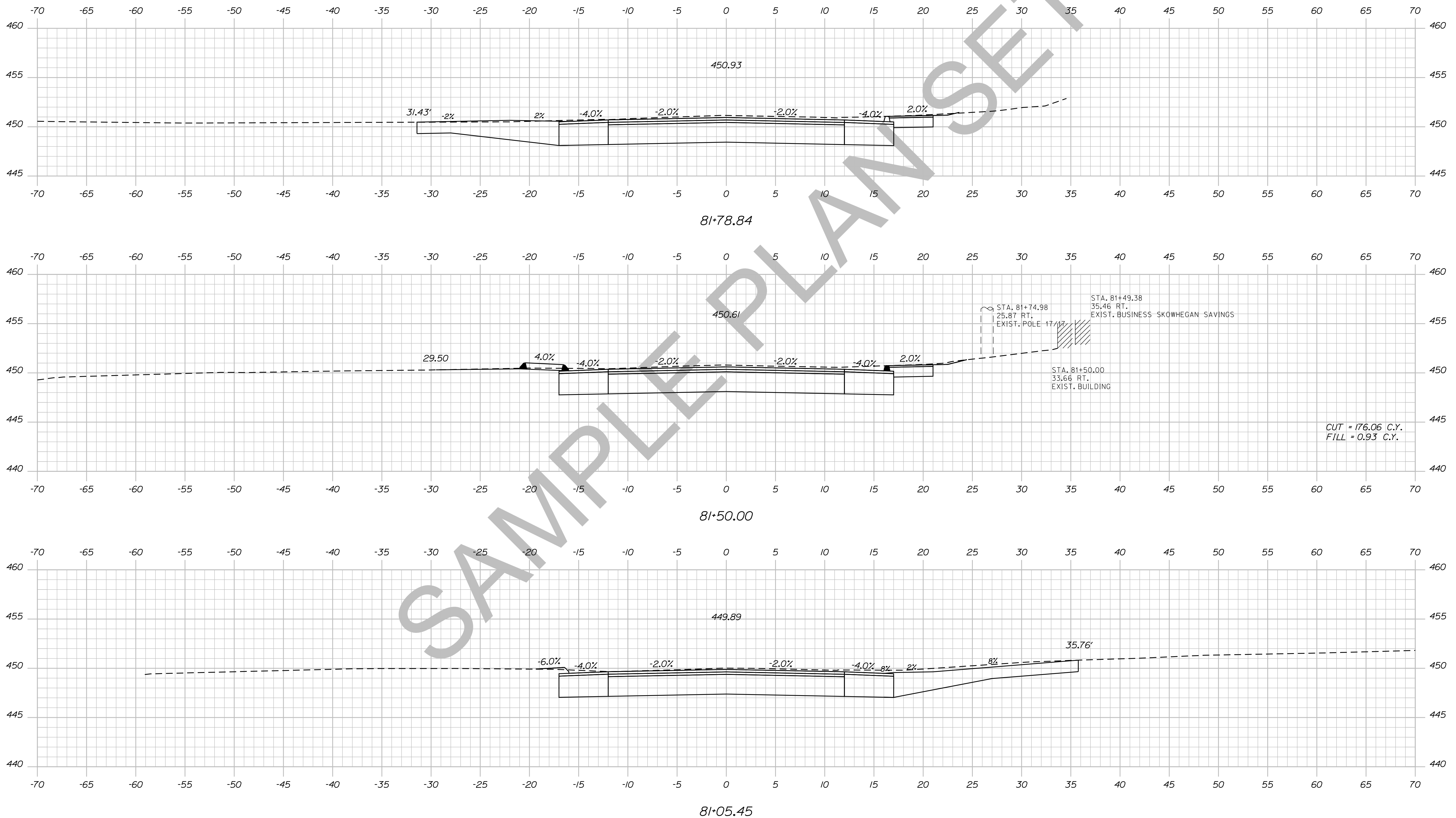

STATE OF MAINE  
DEPARTMENT OF TRANSPORTATION  
018246.00  
PIN 18246.00  
HIGHWAY PLANS

DATE	BY	PROJ. MANAGER	CHECKED	DESIGNED	REVISIONS	FIELD CHANGES
	TRAVIS WHEEL	ERNEST MARTIN				
			DESIGN DETAILED	DESIGN DETAILED	REVISIONS 1	
			DESIGN REVIEWED	DESIGN REVIEWED	REVISIONS 2	
					REVISIONS 3	
					REVISIONS 4	

DEXTER  
ROUTE 7  
CROSS SECTIONS

SHEET NUMBER  
**118**  
OF 15

Date: 5/19/2014

Username: Allee.Mousseau

Division: HIGHWAY

Filename: ... \119\_XSECT\_82+00\_086.dgn

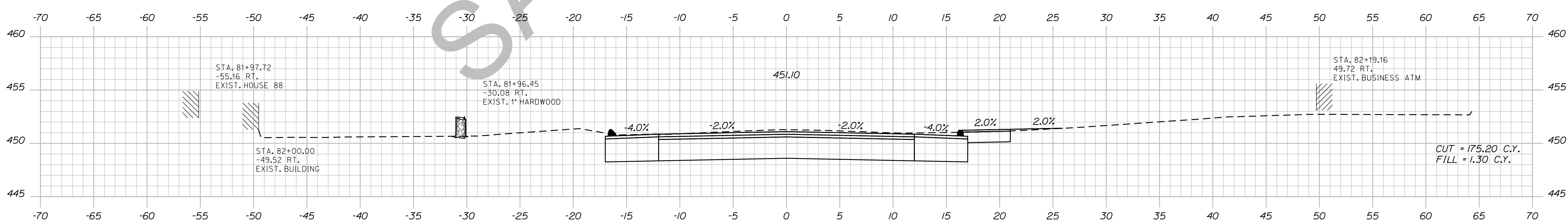
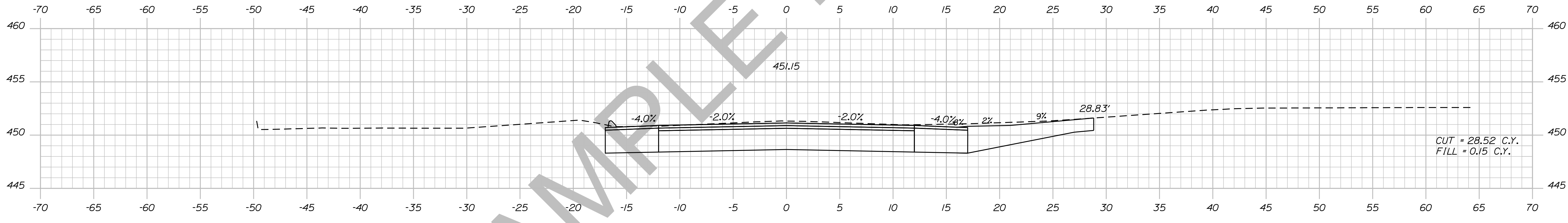
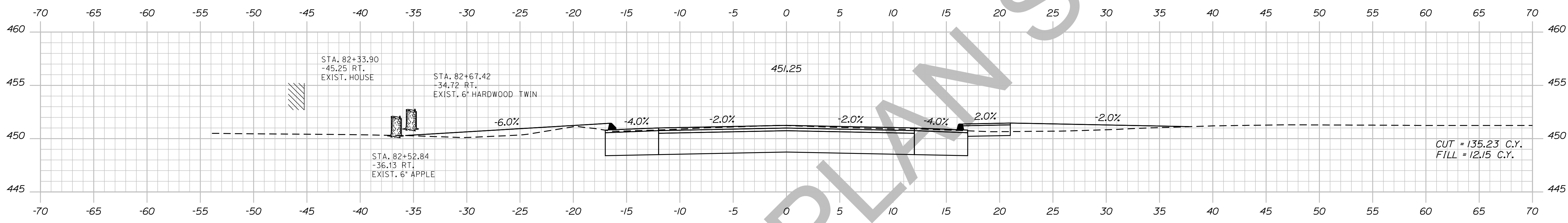
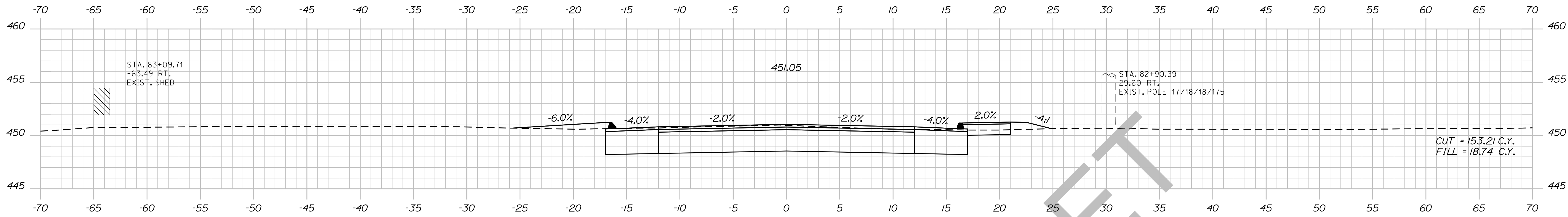

STATE OF MAINE  
DEPARTMENT OF TRANSPORTATION  
018246.00  
PIN 18246.00  
HIGHWAY PLANS

DATE	SIGNATURE	P.E. NUMBER	DATE

PROJ. MANAGER	BY	DATE
ERNEST MARTIN	TRAVIS WHEEL	

DEXTER  
ROUTE 7  
CROSS SECTIONS

SHEET NUMBER  
**119**  
OF 15

Date: 5/19/2014

Username: Alee.Mousseau

Division: HIGHWAY

Filename: ... \120\_XSECT\_83+21\_087.dgn

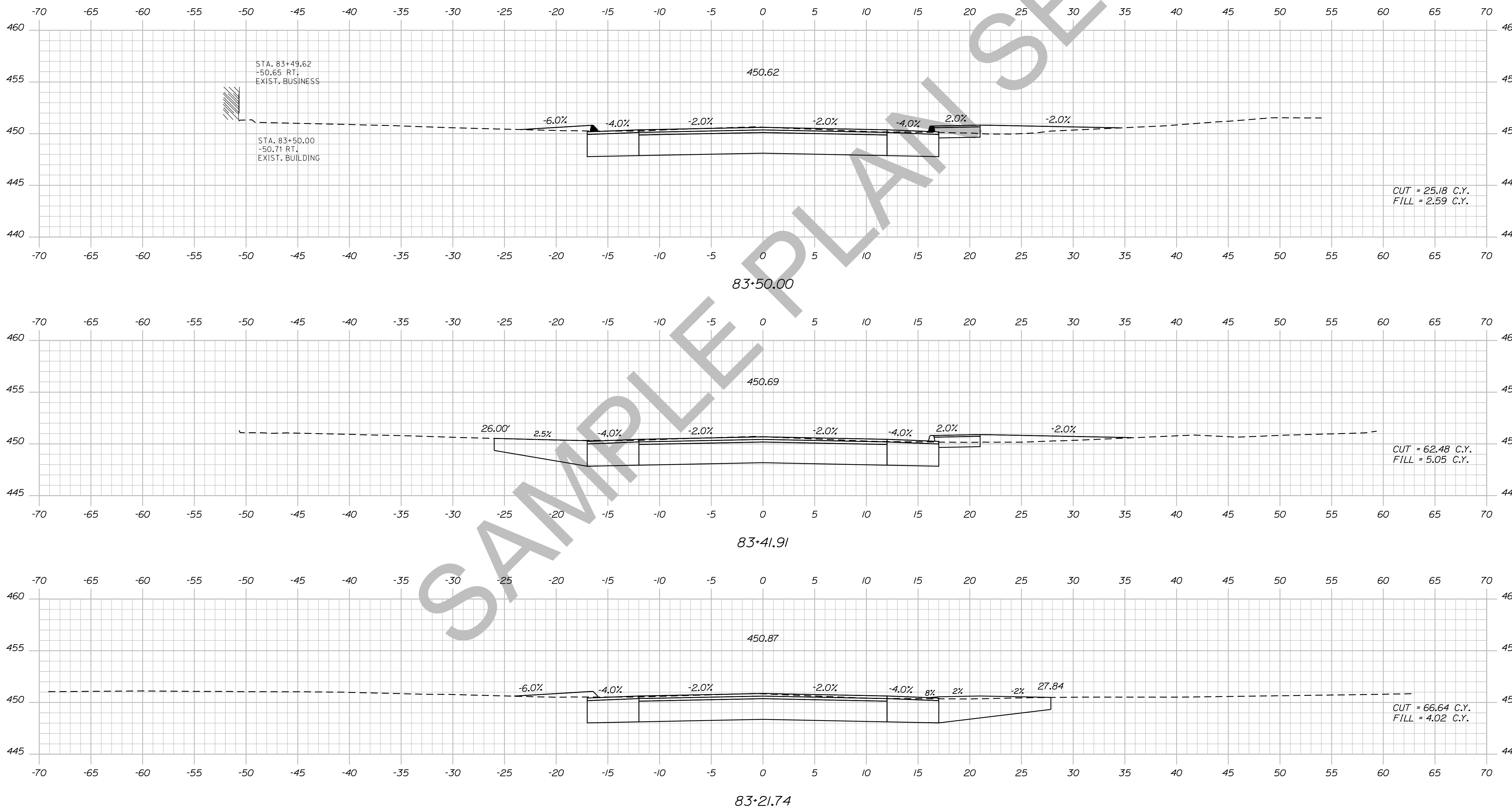

STATE OF MAINE  
DEPARTMENT OF TRANSPORTATION  
018246.00  
PIN 18246.00  
HIGHWAY PLANS

DATE	SIGNATURE	P.E. NUMBER	DATE

PROJ. MANAGER	BY	DATE
ERNEST MARTIN	TRAVIS WHEEL	

DESIGN DETAILED	CHECKED/REVIEWED	DESIGN DETAILED	REVISIONS 1	REVISIONS 2	REVISIONS 3	REVISIONS 4	FIELD CHANGES

DEXTER  
ROUTE 7  
CROSS SECTIONS

SHEET NUMBER  
**120**  
OF 15

Date: 5/19/2014

Username: Ailee.Mousseau

Division: HIGHWAY

Filename: ... \12L\_XSECT\_84+00\_088.dgn

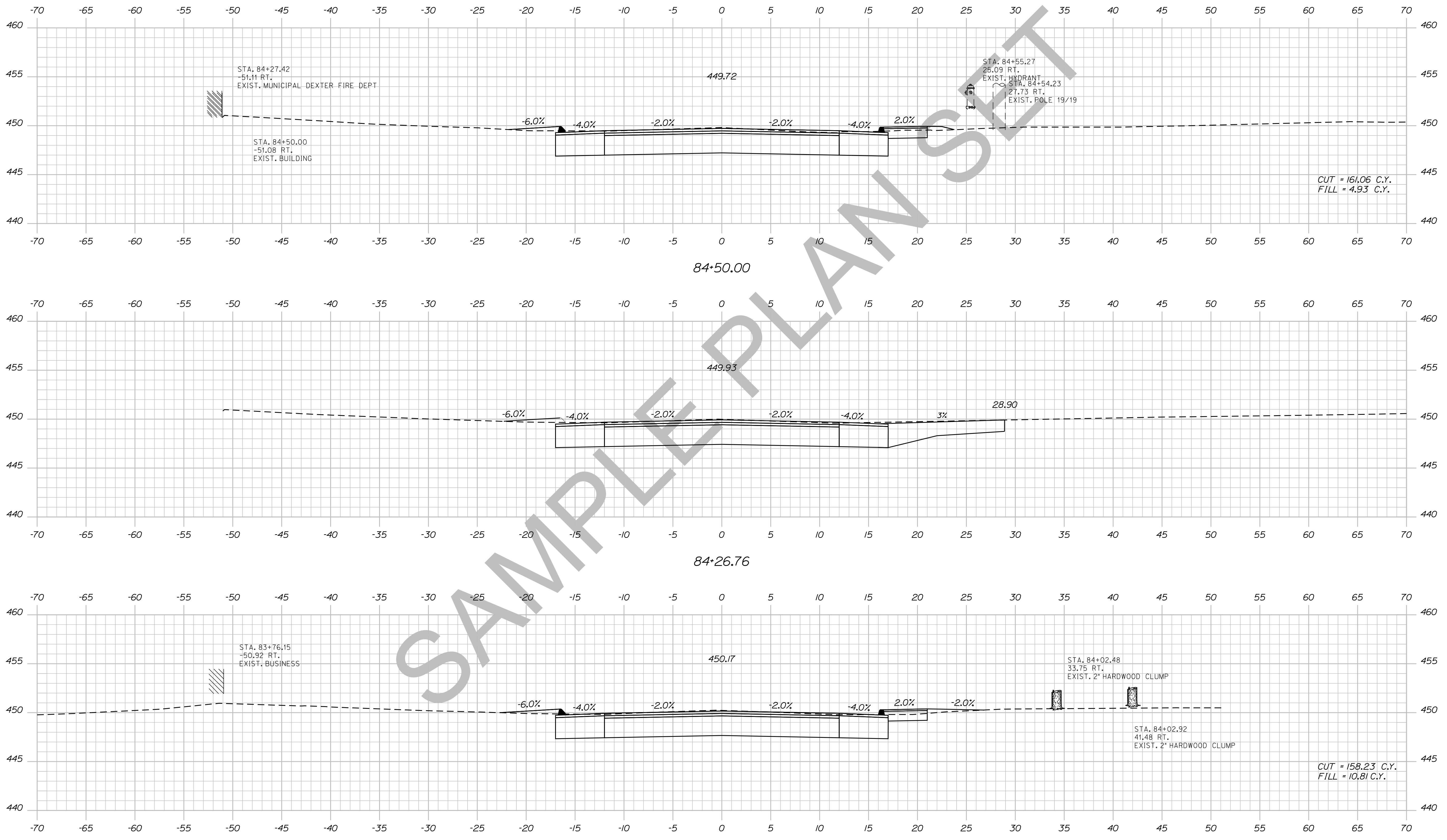

STATE OF MAINE  
DEPARTMENT OF TRANSPORTATION  
018246.00  
PIN 18246.00  
HIGHWAY PLANS

DATE	BY	PROJ. MANAGER	CHECKED	DESIGNED	REVISIONS	FIELD CHANGES
	TRAVIS WOLFE	ERNEST MARTIN				
					1	
					2	
					3	
					4	

DESIGN DETAILED  
CHECKED-REVIEWED  
DESIGNS DETAILED  
DESIGNS DETAILED  
REVISIONS 1  
REVISIONS 2  
REVISIONS 3  
REVISIONS 4  
FIELD CHANGES

DEXTER ROUTE 7  
CROSS SECTIONS

SHEET NUMBER  
121  
OF 15



Date: 5/19/2014

Username: Alee.Mousseau

Division: HIGHWAY

Filename: ... \122\_XSECT\_84+75\_089.dgn

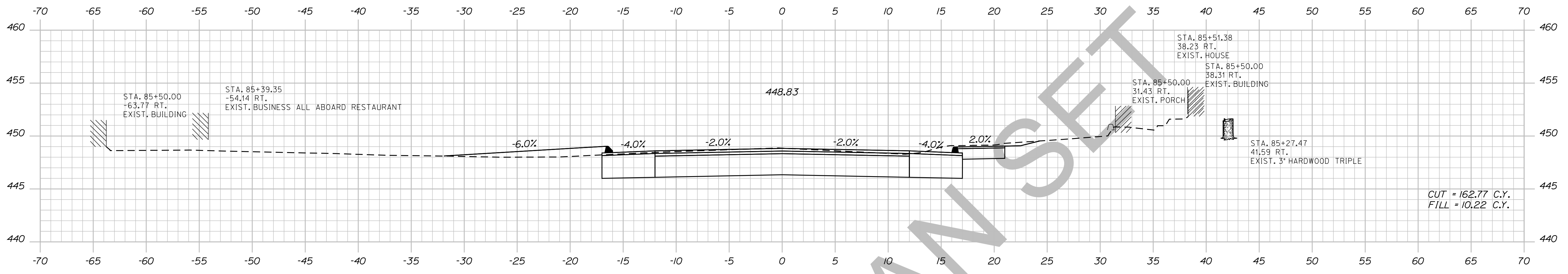

85+50.00

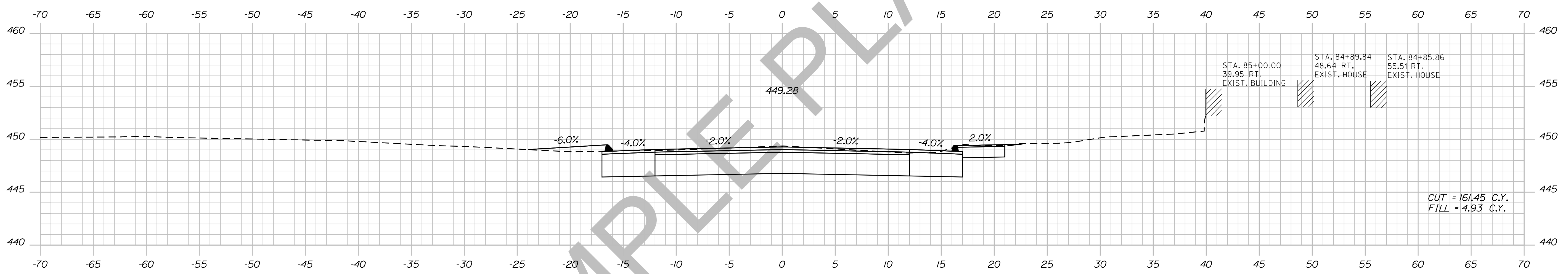

85+00.00

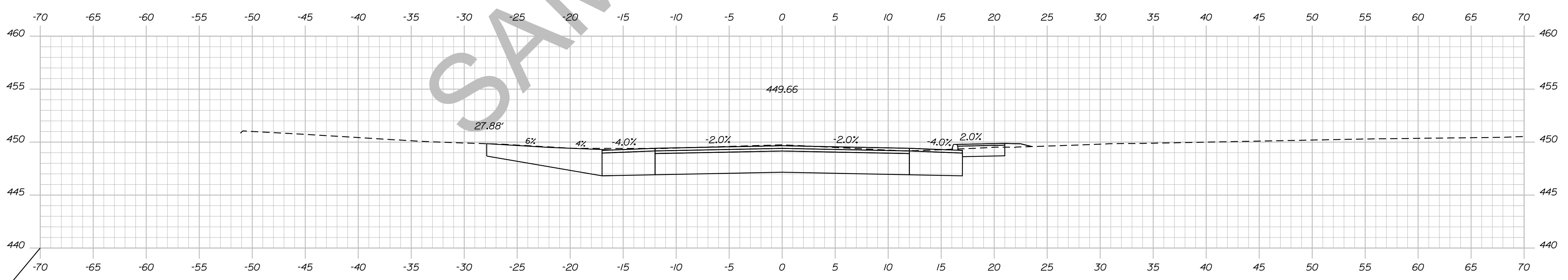

84+57.48

STATE OF MAINE  
DEPARTMENT OF TRANSPORTATION  
018246.00  
PIN 18246.00  
HIGHWAY PLANS

DATE	BY	PROJ. MANAGER	DESIGN-DETAILED	CHECKED-REVIEWED	DESIGN-DETAILED	DESIGN-DETAILED	REVISIONS 1	REVISIONS 2	REVISIONS 3	REVISIONS 4	FIELD CHANGES
	TRAVIS WOLFE	ERNEST MARTIN									

DEXTER  
ROUTE 7  
CROSS SECTIONS

SHEET NUMBER  
**122**  
OF 15

Date: 5/19/2014

Username: Alee.Mousseau

Division: HIGHWAY

Filename: ... \123\_XSECT\_85+50\_090.dgn

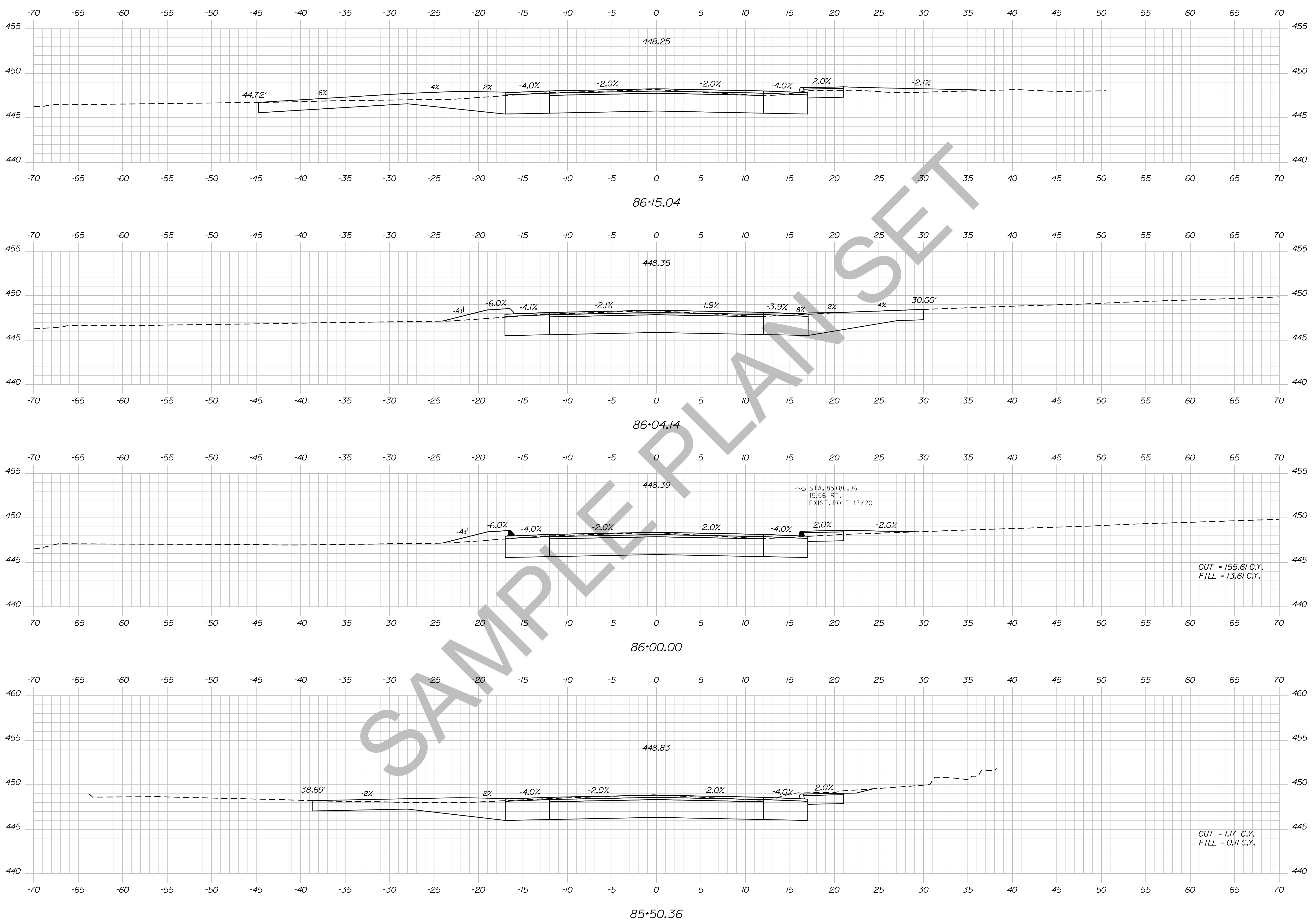

STATE OF MAINE  
DEPARTMENT OF TRANSPORTATION  
018246.00  
PIN 18246.00  
HIGHWAY PLANS

PROJ. MANAGER	BY	DATE	SIGNATURE	P.E. NUMBER	DATE
ERNEST MARTIN	TRAVIS WOLFE				
DESIGN-DETAILED					
CHECKED-REVIEWED					
DESIGN-DETAILED					
REVISIONS 1					
REVISIONS 2					
REVISIONS 3					
REVISIONS 4					
FIELD CHANGES					

DEXTER  
ROUTE 7  
CROSS SECTIONS

SHEET NUMBER  
**123**  
OF 15

Date: 5/19/2014

Username: Allee.Mousseau

Division: HIGHWAY

Filename: ... \124\_XSECT\_86+50\_091.dgn

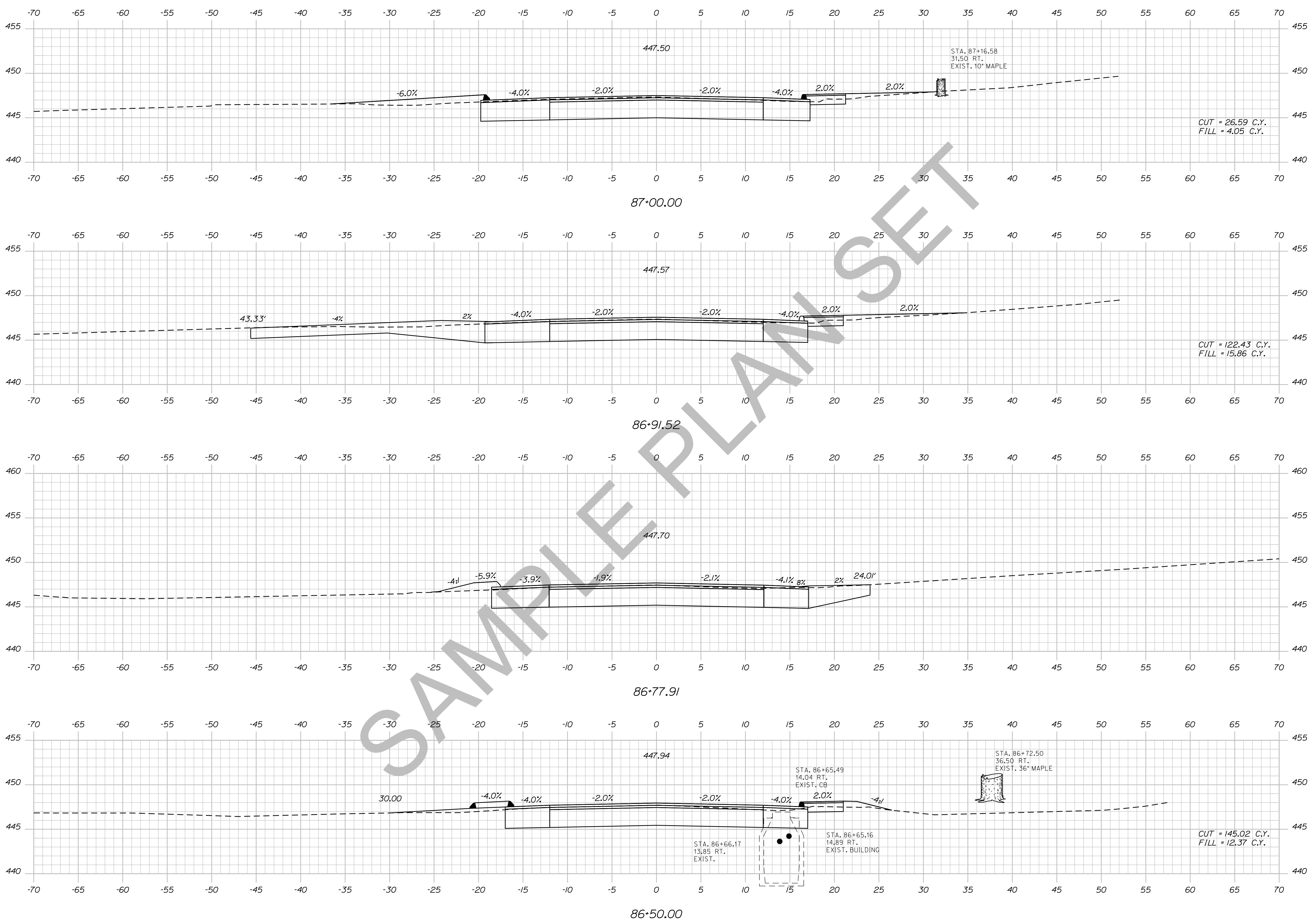

STATE OF MAINE  
DEPARTMENT OF TRANSPORTATION  
018246.00  
PIN 18246.00  
HIGHWAY PLANS

DATE	BY	PROJ. MANAGER	CHECKED	DESIGNED	REVISIONS	SIGNATURE	P.E. NUMBER	DATE
	TRAVIS WOLFE	ERNEST MARTIN			1			
					2			
					3			
					4			
					FIELD CHANGES			

DEXTER  
ROUTE 7  
CROSS SECTIONS

SHEET NUMBER  
124  
OF 15

Sta. 86+50.00 to Sta. 87+00.00

Date: 5/19/2014

Username: Allee.Mousseau

Division: HIGHWAY

Filename: ... \125\_XSECT\_87+50\_092.dgn

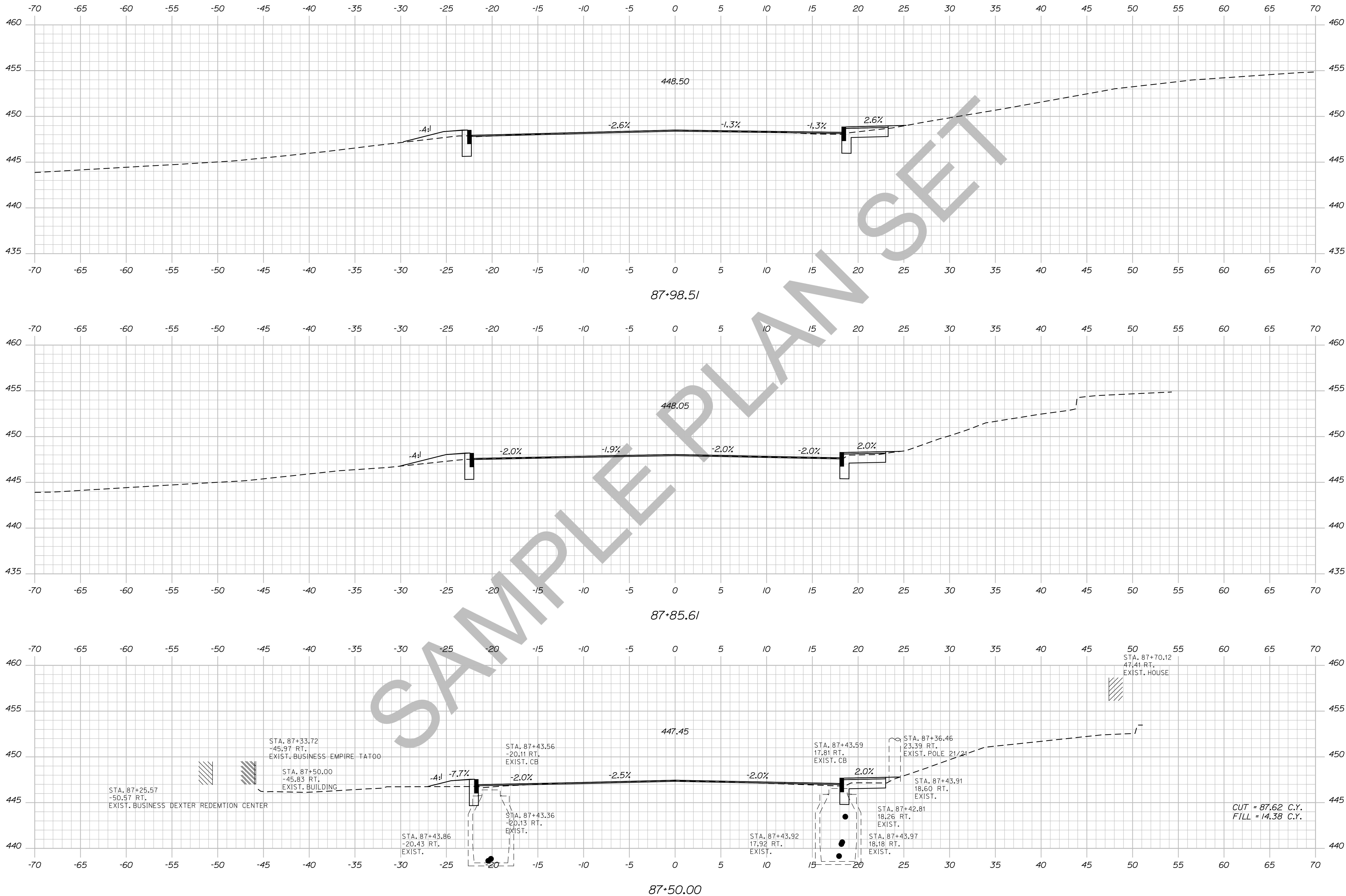

STATE OF MAINE DEPARTMENT OF TRANSPORTATION		018246.00	
		PIN 18246.00	
		HIGHWAY PLANS	
PROJ. MANAGER	ERNEST MARTIN	BY	DATE
CHECKED	TRAVIS WEL		
DESIGNED		SIGNATURE	
REVISIONS 1		P.E. NUMBER	
REVISIONS 2		DATE	
REVISIONS 3			
REVISIONS 4			
FIELD CHANGES			
DEXTER ROUTE 7 CROSS SECTIONS			
SHEET NUMBER			
125			
OF 15			

Date: 5/19/2014

Username: Allee.Mousseau

Division: HIGHWAY

Filename: ... \126\_XSECT\_88-00\_093.dgn

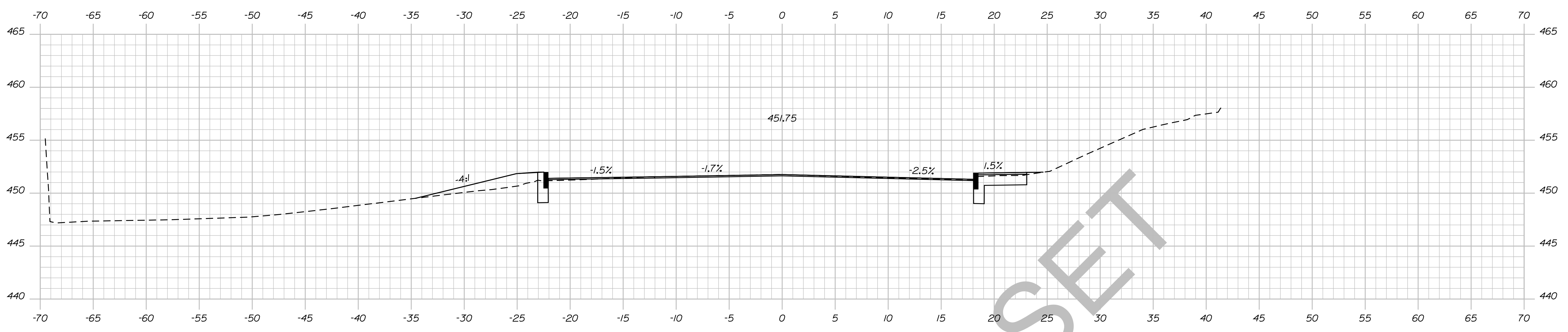

88+64.91



88+50.00

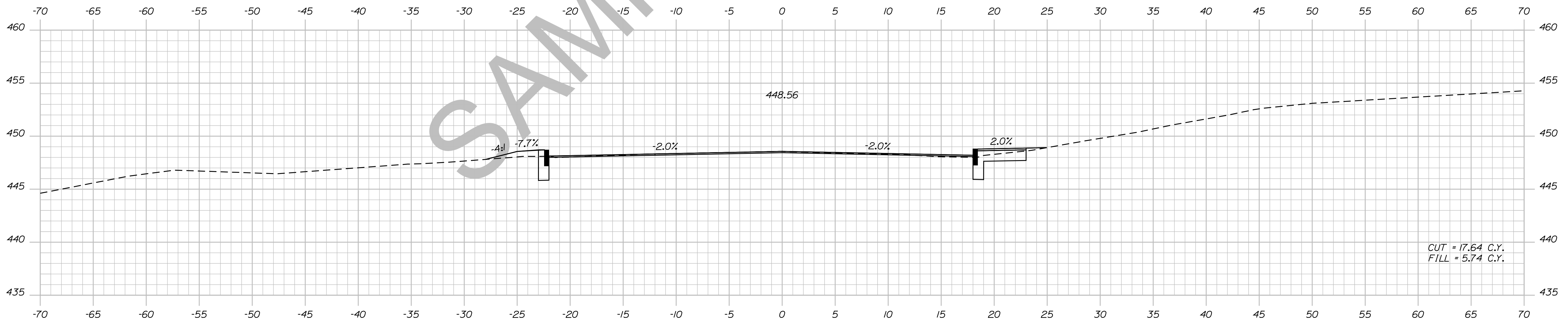

88+00.00

STATE OF MAINE  
DEPARTMENT OF TRANSPORTATION  
018246-00  
PIN 18246.00  
HIGHWAY PLANS

DESIGN	DATE	BY
DESIGNED		ERNEST MARTIN
CHECKED		TRAVIS WITTEL
DESIGNED		
REVISIONS		
REVISIONS		
REVISIONS		
FIELD CHANGES		

DEXTER  
ROUTE 7  
CROSS SECTIONS

SHEET NUMBER  
**126**  
OF 15

Date: 5/19/2014

Username: Alee.Mousseau

Division: HIGHWAY

Filename: ... \127\_XSECT\_89-00\_094.dgn

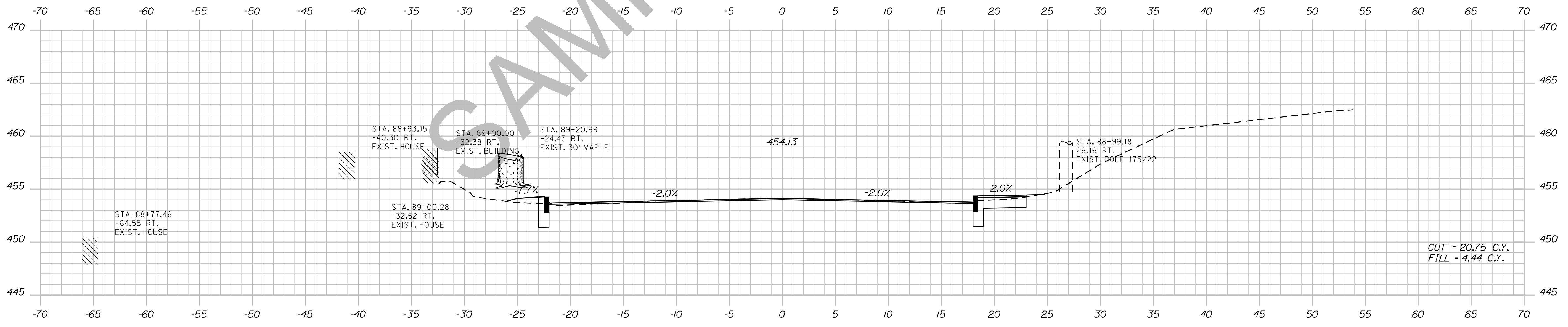
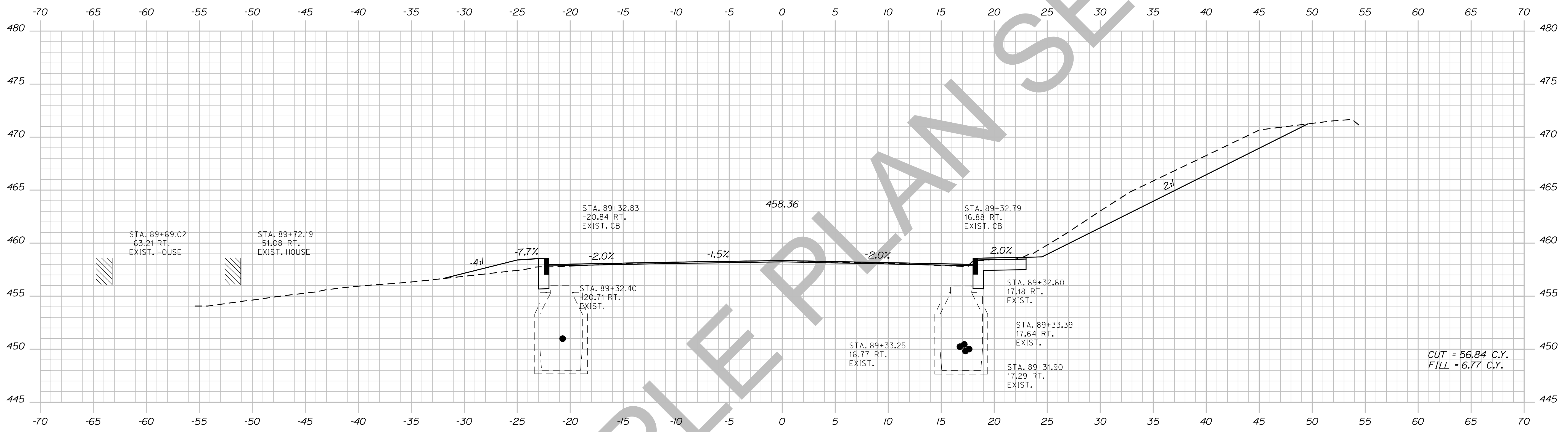

STATE OF MAINE  
DEPARTMENT OF TRANSPORTATION  
018246.00  
PIN  
18246.00  
HIGHWAY PLANS

DESIGN-DETAILED	CHECKED-REVIEWED	DESIGNS-DETAILED	REVISIONS 1	REVISIONS 2	REVISIONS 3	REVISIONS 4	FIELD CHANGES
TRAVIS WOLEL							
DATE							
BY							
PROJ. MANAGER	ERNEST MARTIN						
SIGNATURE							
P.E. NUMBER							
DATE							

DEXTER  
ROUTE 7  
CROSS SECTIONS

SHEET NUMBER  
**127**  
OF 15

Sta. 89+00.00 to Sta. 89+50.00



Date: 5/19/2014

Username: Alee.Mousseau

Division: HIGHWAY

Filename: ... \128\_XSECT\_89-51\_095.dgn

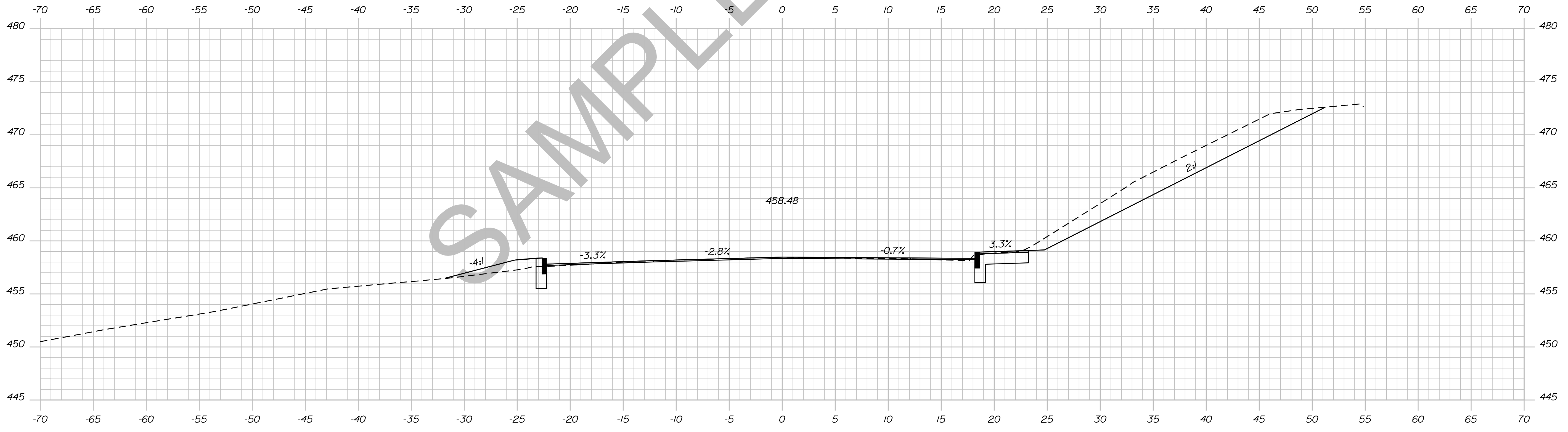
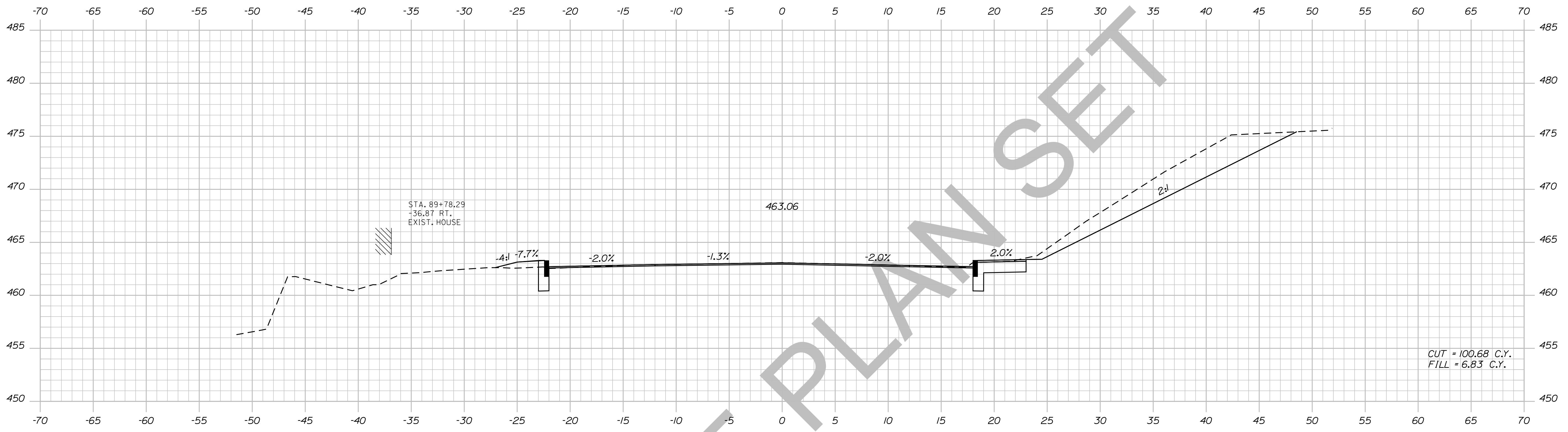

STATE OF MAINE  
DEPARTMENT OF TRANSPORTATION  
018246.00  
PIN 18246.00  
HIGHWAY PLANS

SIGNATURE  
P.E. NUMBER  
DATE

PROJ. MANAGER	ERNEST MARTIN	BY	DATE
CHECKED-REVIEWED	TRAVIS WITTEL		
DESIGNS DETAILED			
DESIGNS DETAILED			
REVISIONS 1			
REVISIONS 2			
REVISIONS 3			
REVISIONS 4			
FIELD CHANGES			

DEXTER  
ROUTE 7  
CROSS SECTIONS

SHEET NUMBER  
128  
OF 15

Date: 5/19/2014

Username: Allee.Mousseau

Division: HIGHWAY

Filename: ... \129\_XSECT\_90+18\_096.dgn

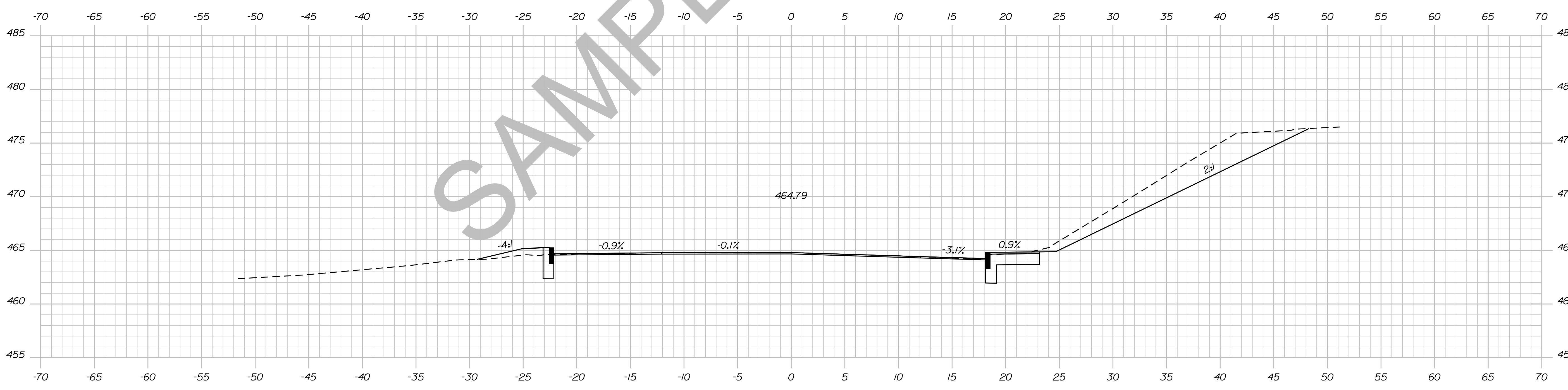
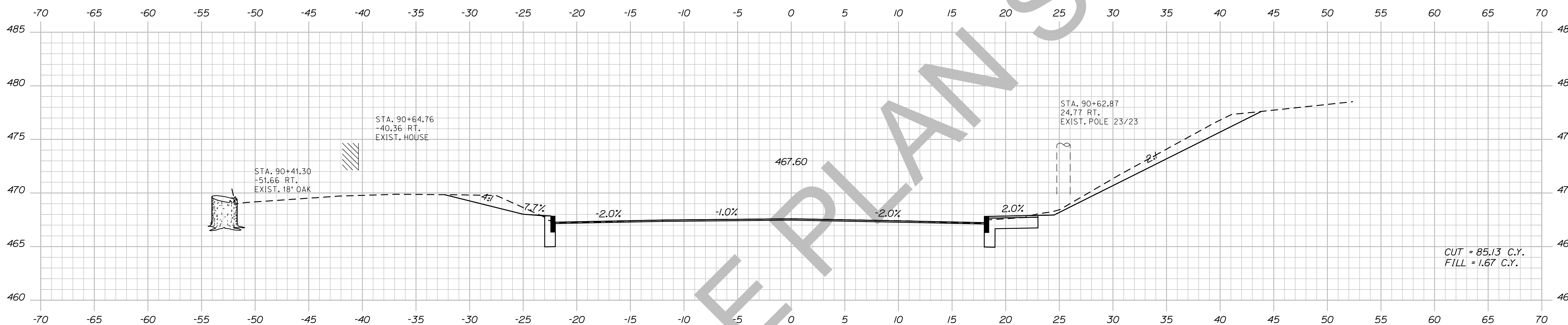

SAMPLE PLAN SET

STATE OF MAINE  
DEPARTMENT OF TRANSPORTATION  
018246.00  
PIN  
18246.00  
HIGHWAY PLANS

DESIGN/REVIEWED	DATE	SIGNATURE
PROJ. MANAGER ERNEST MARTIN		
CHECKED-REVIEWED TRAVIS WHEEL		
DESIGN/DET AILED		P.E. NUMBER
DESIGN/DET AILED		DATE
REVISIONS 1		
REVISIONS 2		
REVISIONS 3		
REVISIONS 4		
FIELD CHANGES		

DEXTER  
ROUTE 7  
CROSS SECTIONS

SHEET NUMBER  
**129**  
OF 15

Date: 5/19/2014

Username: Alee.Mousseau

Division: HIGHWAY

Filename: ... \130\_XSECT\_90+88\_097.dgn

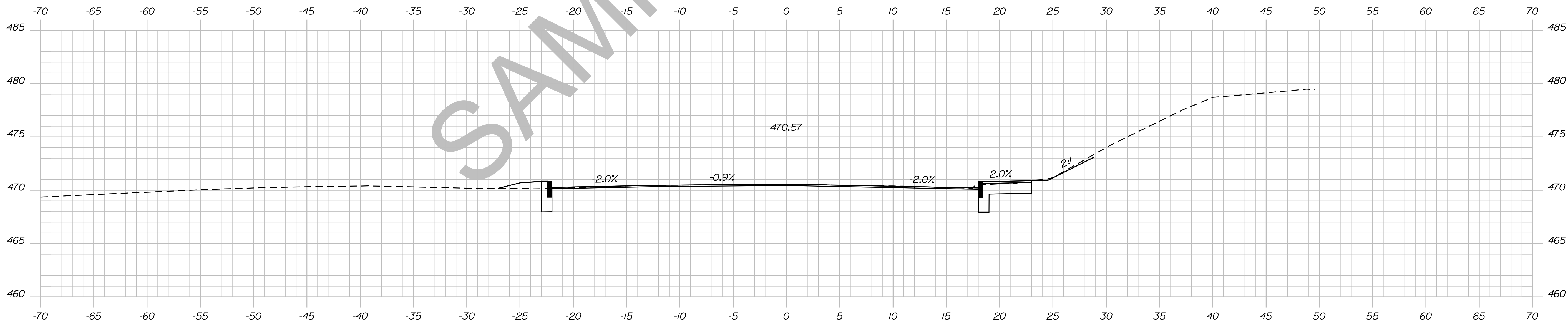
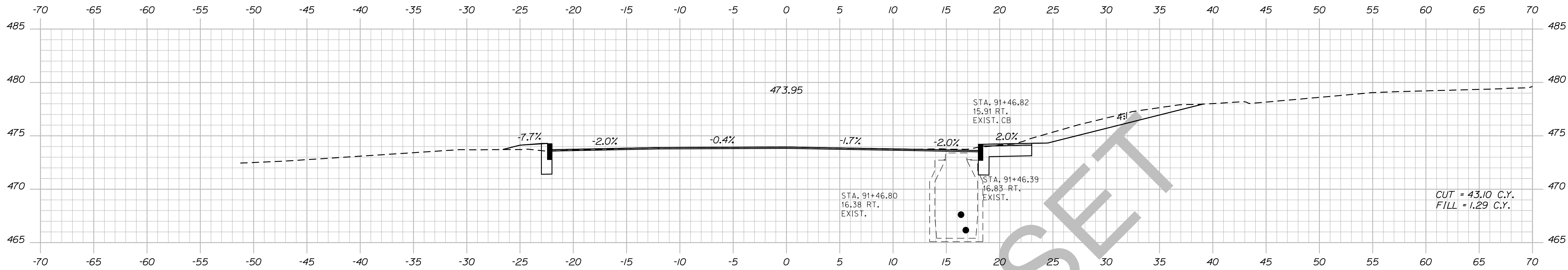

STATE OF MAINE DEPARTMENT OF TRANSPORTATION		018246.00	PIN 18246.00	HIGHWAY PLANS
Dexter Route 7 CROSS SECTIONS				
PROJ. MANAGER	ERNEST MARTIN	BY	DATE	
DESIGN-DETAILED	TRAVIS WOLFE			SIGNATURE
CHECKED-REVIEWED				P.E. NUMBER
DESIGN-DETAILED				DATE
REVISIONS 1				
REVISIONS 2				
REVISIONS 3				
REVISIONS 4				
FIELD CHANGES				
SHEET NUMBER				
130				
OF 15				

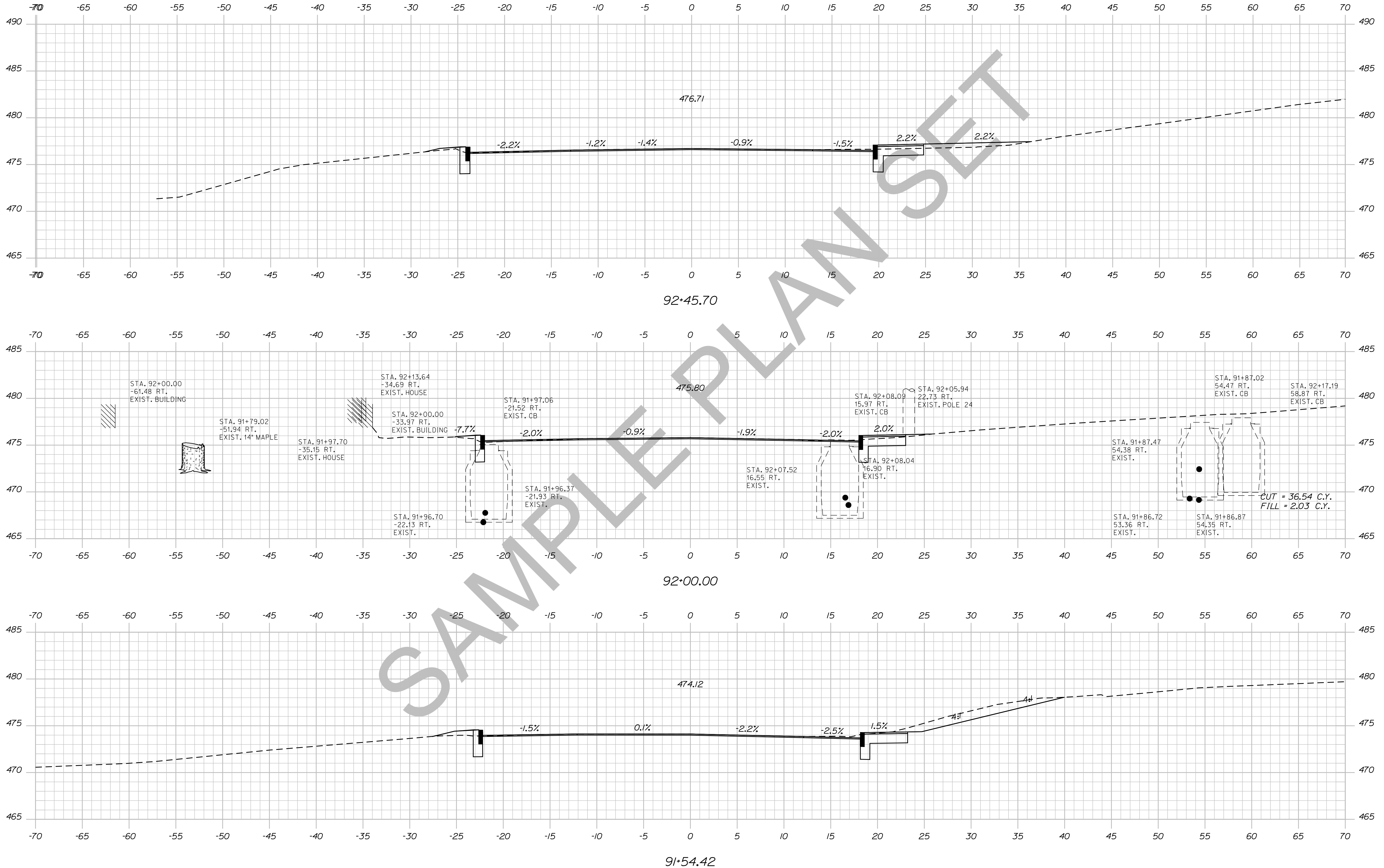

STATE OF MAINE  
 DEPARTMENT OF TRANSPORTATION  
 018246.00  
 PIN 18246.00  
 HIGHWAY PLANS

DATE	BY	PROJ. MANAGER	DESIGN-DETAILED	CHECKED-REVIEWED	DESIGN-DETAILED	DESIGN-DETAILED	REVISIONS 1	REVISIONS 2	REVISIONS 3	REVISIONS 4	FIELD CHANGES
		ERNEST MARTIN	TRAVIS WHEEL								

DEXTER  
 ROUTE 7  
 CROSS SECTIONS

SHEET NUMBER  
 131  
 OF 15

Date: 5/19/2014

Username: Alee.Mousseau

Division: HIGHWAY

Filename: ... \132\_XSECT\_92+50\_099.dgn

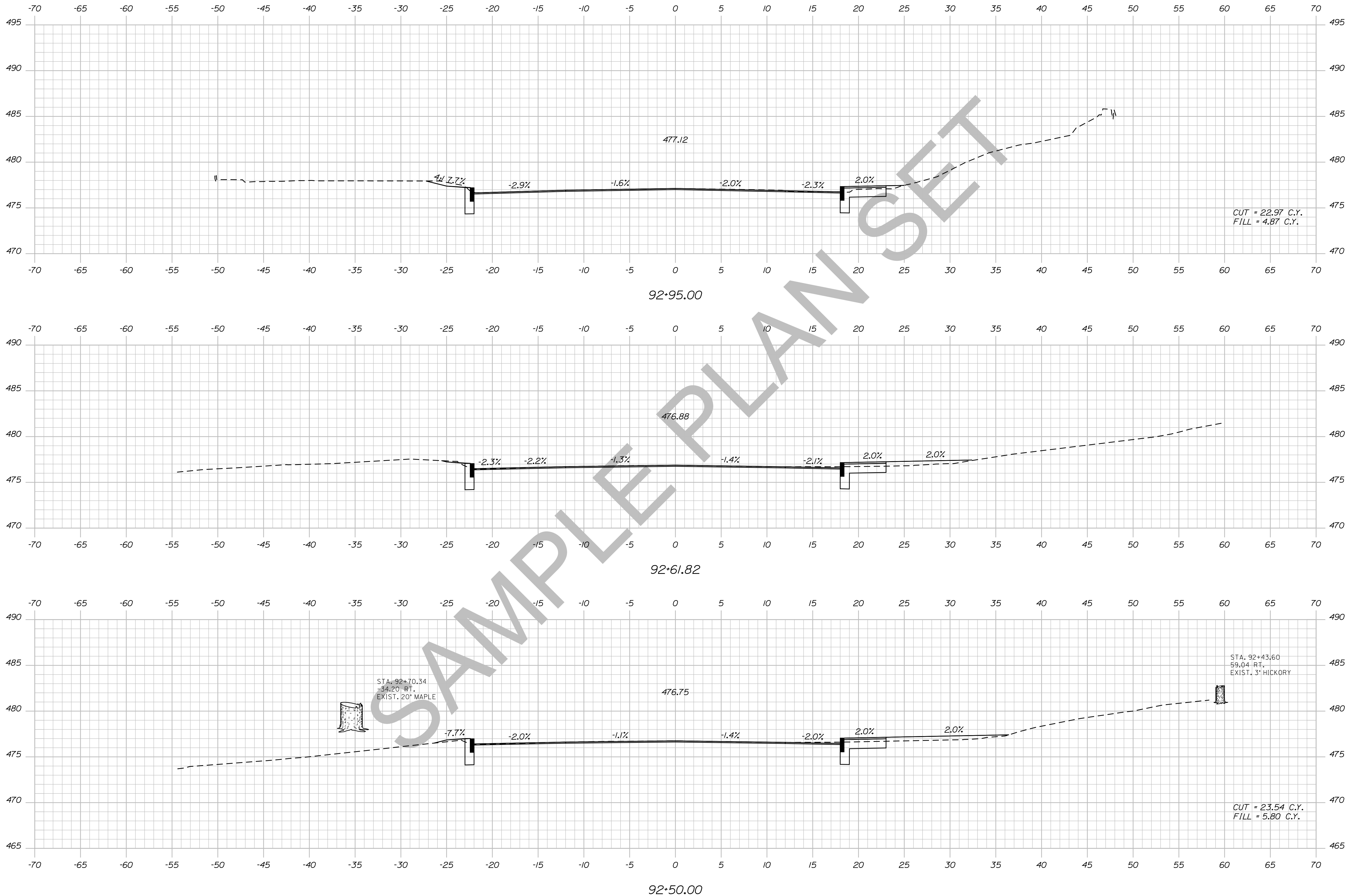

STATE OF MAINE  
 DEPARTMENT OF TRANSPORTATION  
 018246.00  
 PIN  
 18246.00  
 HIGHWAY PLANS

DESIGNED	CHECKED	DESIGNED	REVISIONS	REVISIONS	REVISIONS	FIELD
DATE	DATE	DATE	1	2	3	CHANGES
TRAVIS WOLFE						

PROJ. MANAGER	BY	DATE	SIGNATURE	P.E. NUMBER	DATE
ERNEST MARTIN	TRAVIS WOLFE				

DEXTER  
 ROUTE 7  
 CROSS SECTIONS

SHEET NUMBER  
 132  
 OF 15

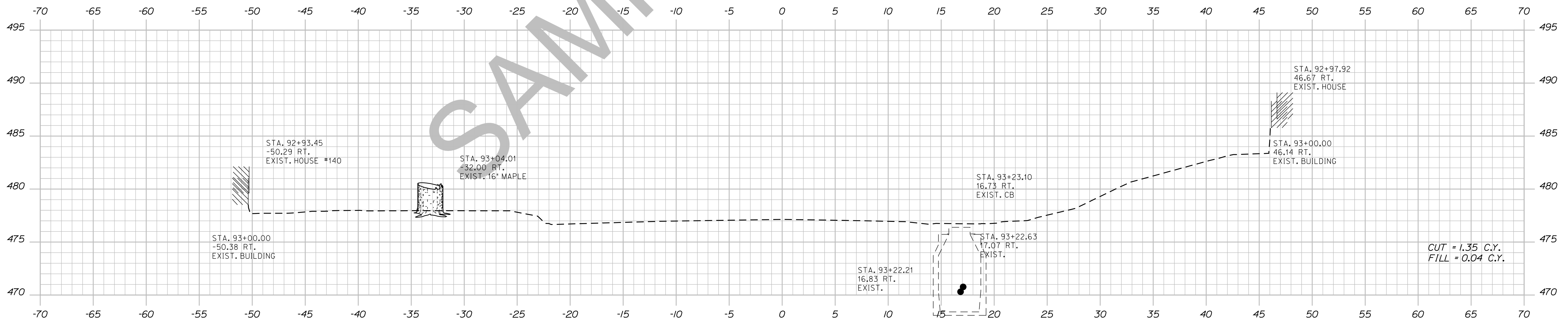
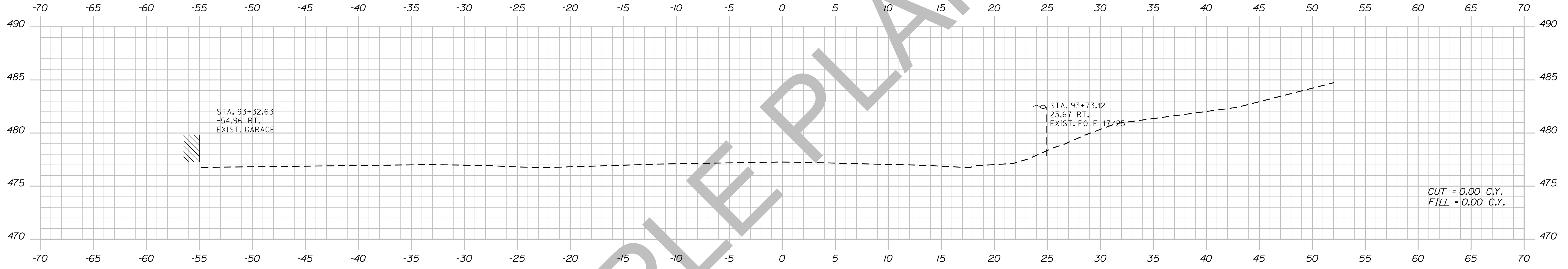

SAMPLE PLAN SET

STATE OF MAINE  
DEPARTMENT OF TRANSPORTATION  
018246.00  
PIN  
18246.00  
HIGHWAY PLANS

PROJ. MANAGER	ERNEST MARTIN	BY	DATE
CHECKED-REVIEWED	TRAVIS WOLFE		
DESIGNS DETAILED		SIGNATURE	
REVISIONS 1		P.E. NUMBER	
REVISIONS 2		DATE	
REVISIONS 3			
REVISIONS 4			
FIELD CHANGES			

DEXTER  
ROUTE 7  
CROSS SECTIONS

SHEET NUMBER  
**133**  
OF 15



Date: 5/19/2014

Username: Alee.Mousseau

Division: HIGHWAY

Filename: ... \134\_XSECT\_150+00\_101.dgn

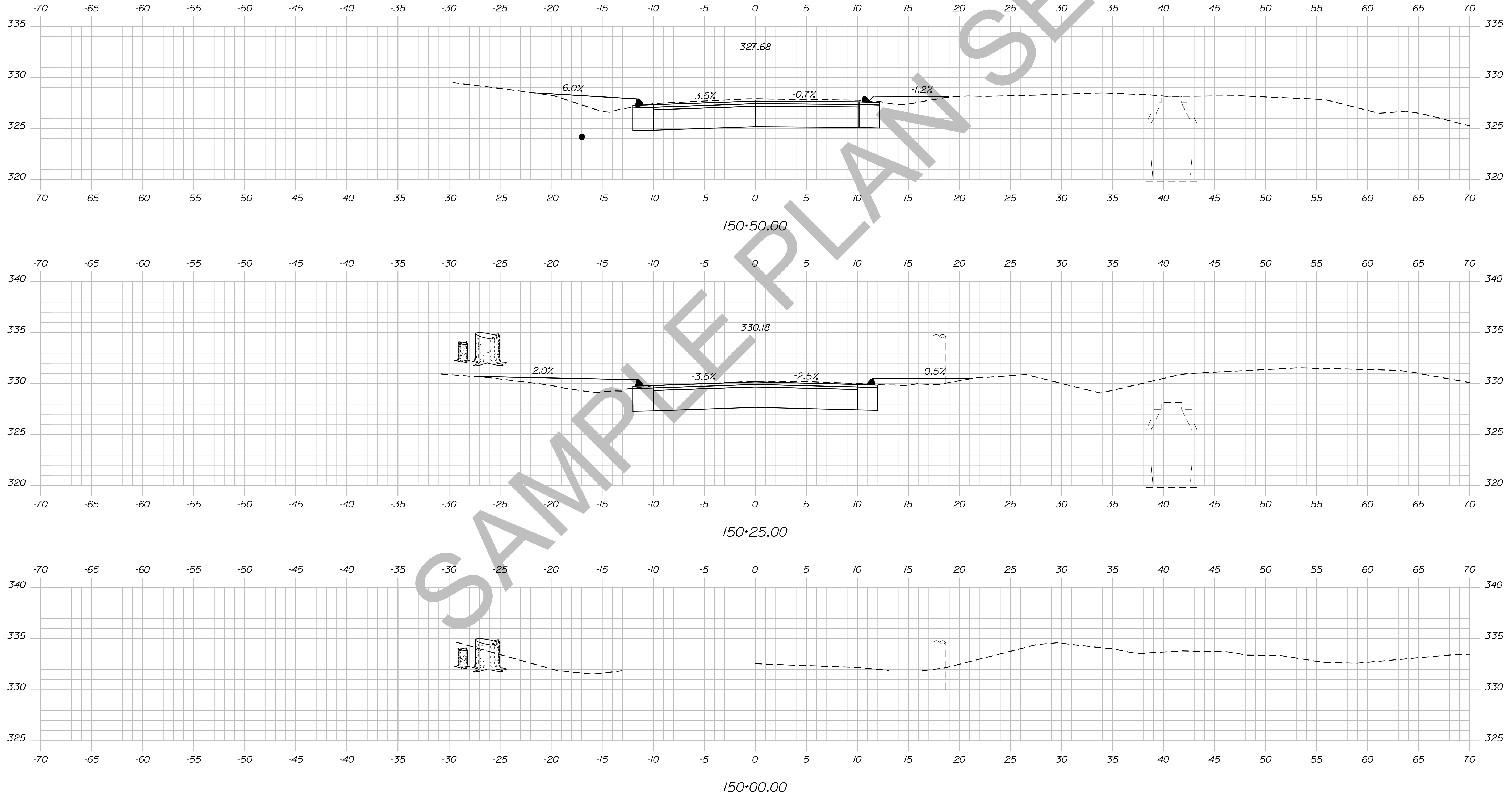

STATE OF MAINE  
DEPARTMENT OF TRANSPORTATION  
018246.00  
PIN  
18246.00  
HIGHWAY PLANS

PROJ. MANAGER	ERNEST MARTIN	BY	DATE
DESIGN-DETAILED	TRAVIS WOLFE		
CHECKED-REVIEWED			
DESIGN-DETAILED			
DESIGN-DETAILED			
REVISIONS 1			
REVISIONS 2			
REVISIONS 3			
REVISIONS 4			
FIELD CHANGES			

DEXTER  
ROUTE 7  
CROSS SECTIONS

SHEET NUMBER  
**134**  
OF 15

Date: 5/19/2014

Username: Alee.Mousseau

Division: HIGHWAY

Filename: ... \135\_XSECT\_150+75\_102.dgn

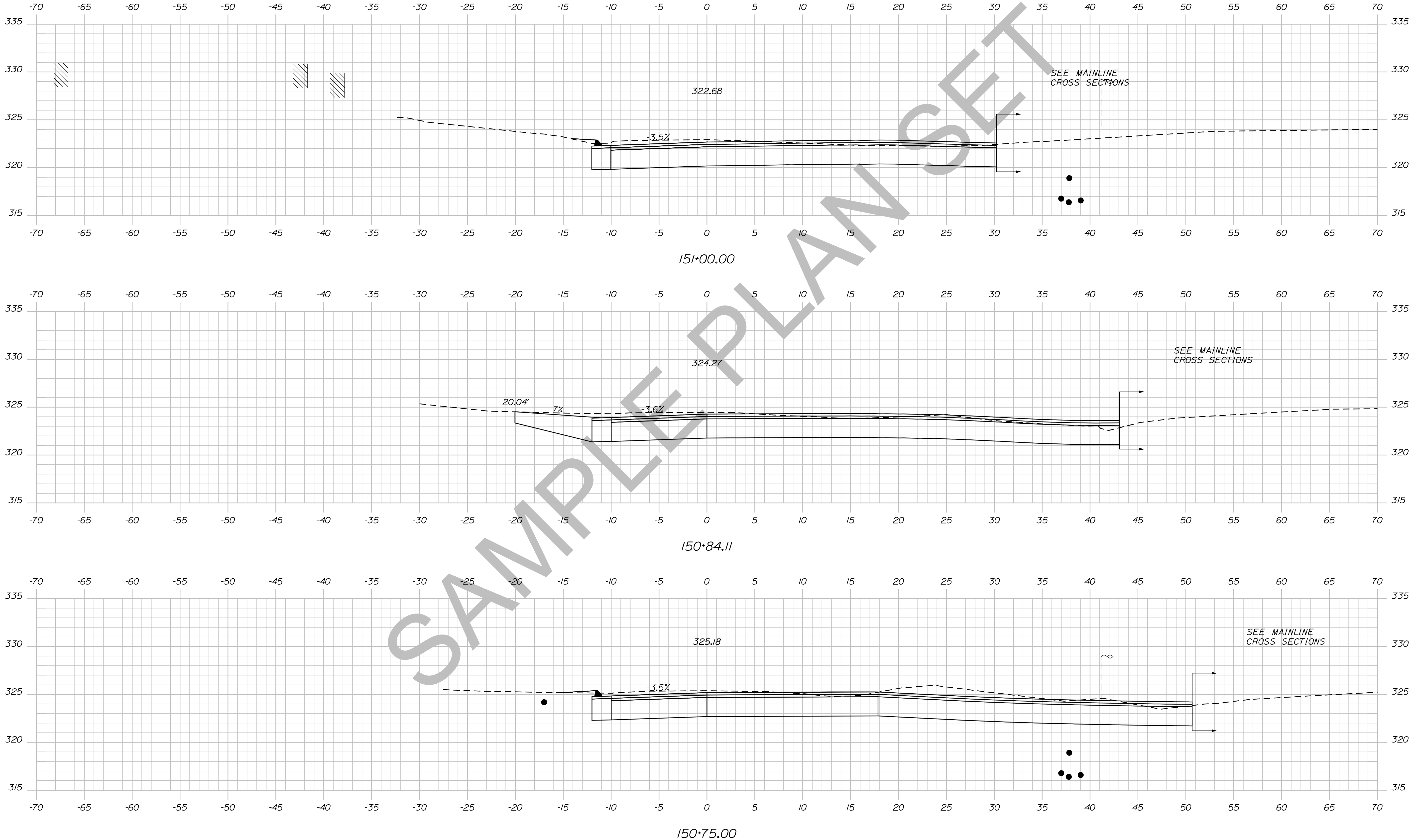

STATE OF MAINE  
DEPARTMENT OF TRANSPORTATION  
018246.00  
PIN  
18246.00  
HIGHWAY PLANS

PROJ. MANAGER	ERNEST MARTIN	BY	DATE
CHECKED-REVIEWED	TRAVIS WOLFE		
DESIGN-DETAILED			
DESIGN-DETAILED			
REVISIONS 1			
REVISIONS 2			
REVISIONS 3			
REVISIONS 4			
FIELD CHANGES			

DEXTER  
ROUTE 7  
CROSS SECTIONS

SHEET NUMBER  
**135**  
OF 15

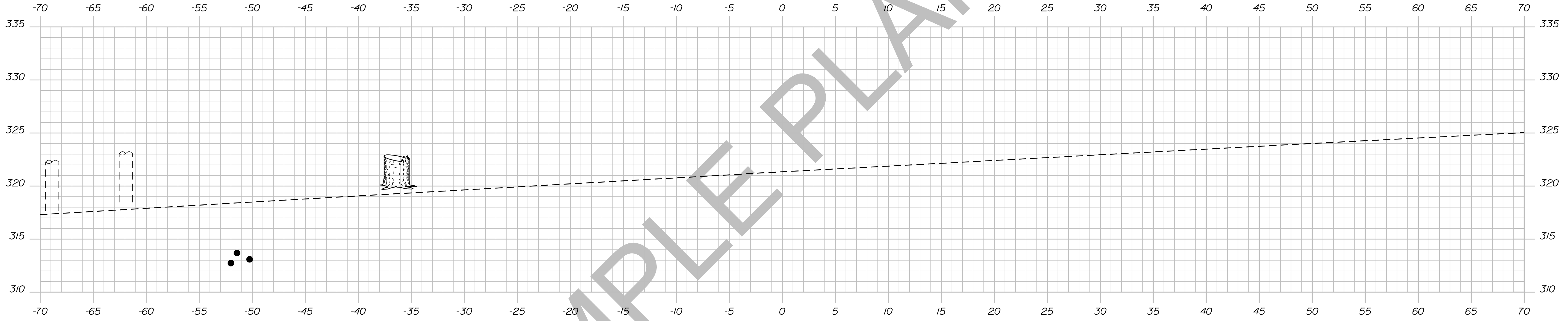

151+41.00

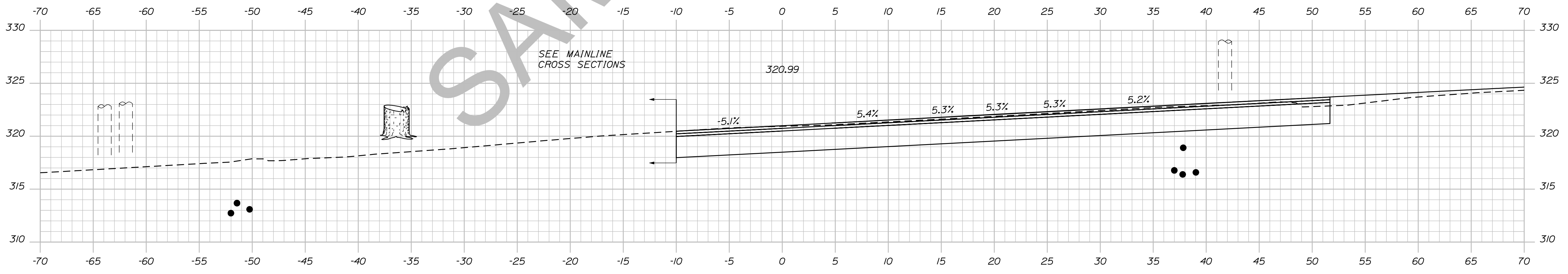

151+25.00

STATE OF MAINE  
DEPARTMENT OF TRANSPORTATION  
018246.00  
PIN  
18246.00  
HIGHWAY PLANS

PROJ. MANAGER	ERNEST MARTIN	BY	DATE
CHECKED-REVIEWED	TRAVIS WEL		
DESIGN DETAILED		SIGNATURE	
DESIGNS DETAILED		P.E. NUMBER	
REVISIONS 1		DATE	
REVISIONS 2			
REVISIONS 3			
REVISIONS 4			
FIELD CHANGES			

DEXTER  
ROUTE 7  
CROSS SECTIONS

SHEET NUMBER  
**136**  
OF 15

Date: 5/19/2014

Username: Alee.Mousseau

Division: HIGHWAY

Filename: ... \137\_XSECT\_200+00\_104.dgn

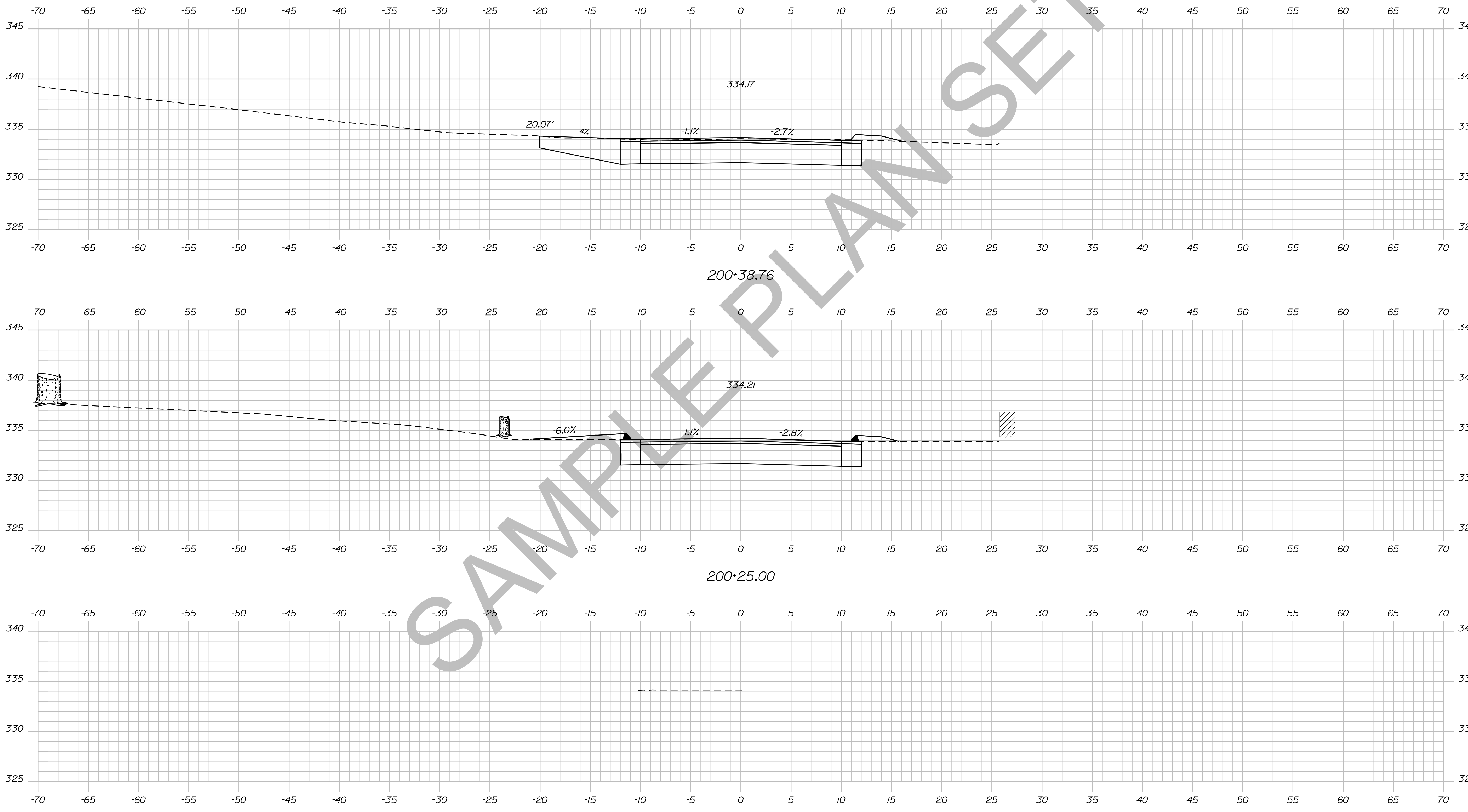

STATE OF MAINE  
DEPARTMENT OF TRANSPORTATION  
018246.00  
PIN  
18246.00  
HIGHWAY PLANS

SIGNATURE
P.E. NUMBER
DATE

PROJ. MANAGER	BY	DATE
ERNEST MARTIN	TRAVIS WEL	
DESIGN-DETAILED		
CHECKED-REVIEWED		
DESIGN-DETAILED		
DESIGN-DETAILED		
REVISIONS 1		
REVISIONS 2		
REVISIONS 3		
REVISIONS 4		
FIELD CHANGES		

DEXTER  
ROUTE 7  
CROSS SECTIONS

SHEET NUMBER  
**137**  
OF 15

Date: 5/19/2014

Username: Alee.Mousseau

Division: HIGHWAY

Filename: ... \138\_XSECT\_200+49\_105.dgn

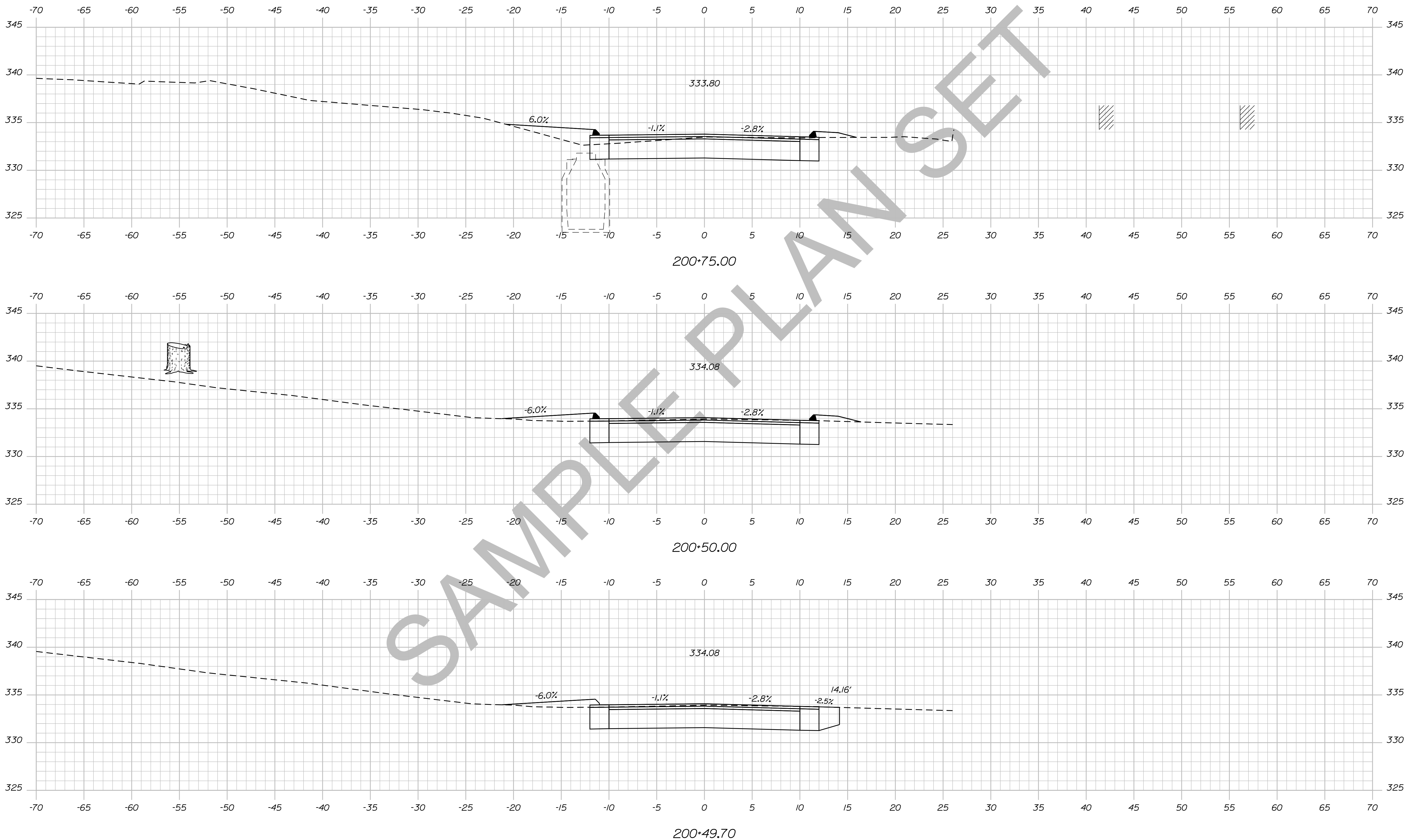

STATE OF MAINE  
DEPARTMENT OF TRANSPORTATION  
018246.00  
PIN  
18246.00  
HIGHWAY PLANS

PROJ. MANAGER	ERNEST MARTIN	BY	DATE
CHECKED-REVIEWED	TRAVIS WOLFE		
DESIGN-DETAILED		SIGNATURE	
DESIGNS DET AILED		P.E. NUMBER	
REVISIONS 1		DATE	
REVISIONS 2			
REVISIONS 3			
REVISIONS 4			
FIELD CHANGES			

DEXTER  
ROUTE 7  
CROSS SECTIONS

SHEET NUMBER  
**138**  
OF 15

Date: 5/19/2014

Username: Alee.Mousseau

Division: HIGHWAY

Filename: ... \139\_XSECT\_200+90\_106.dgn

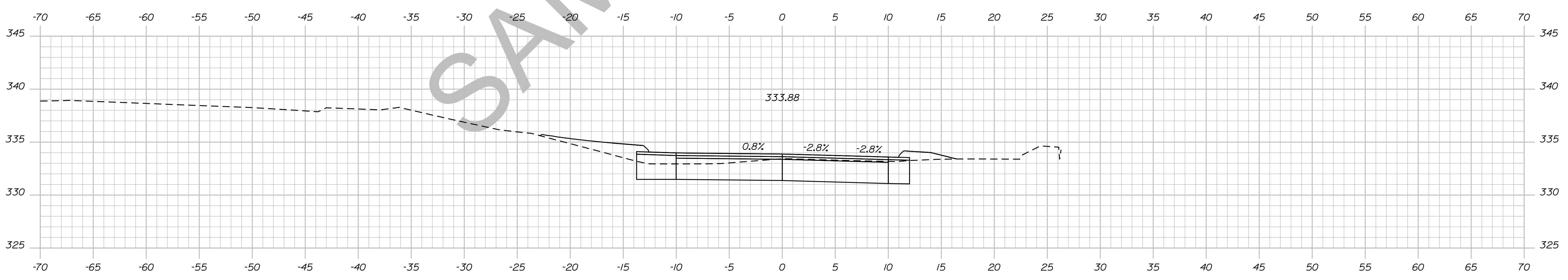
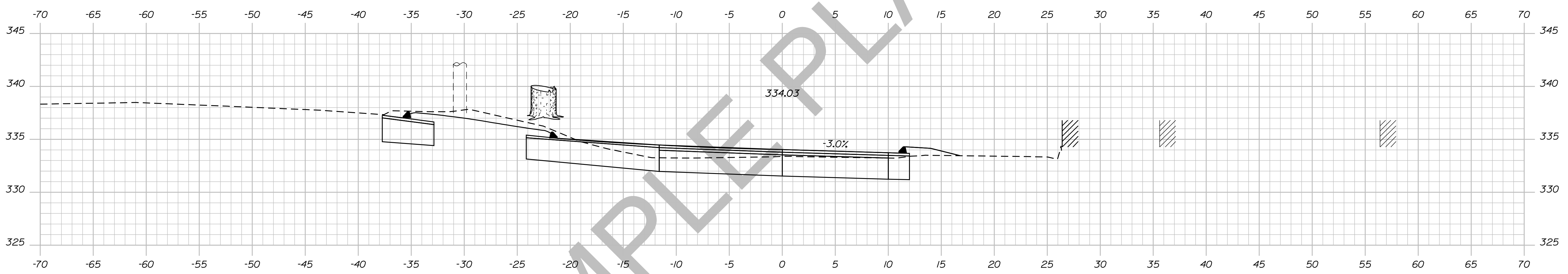
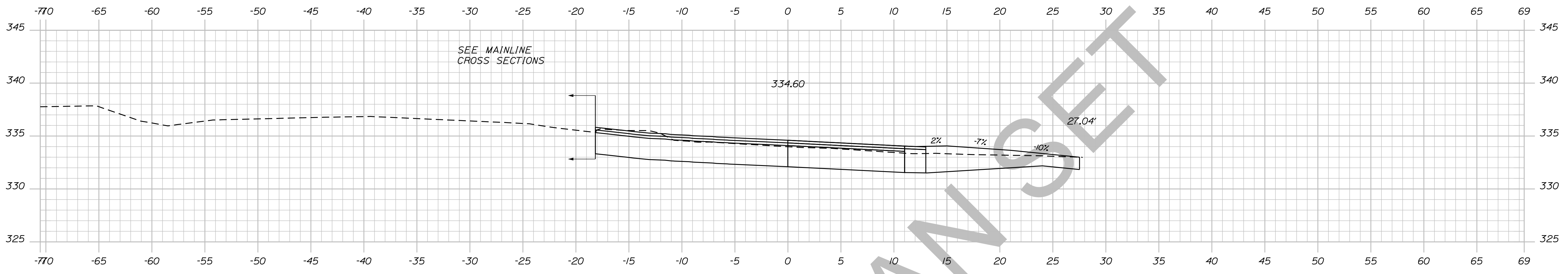

STATE OF MAINE DEPARTMENT OF TRANSPORTATION		018246.00	PIN 18246.00	HIGHWAY PLANS
	SIGNATURE	P.E. NUMBER	DATE	
	BY	DATE		
	PROJ. MANAGER ERNEST MARTIN	TRAVIS WHEELER		
	DESIGN-DETAILED	CHECKED-REVIEWED		
	DESIGNS DET AILED	DESIGNS DET AILED		
	REVISIONS 1	REVISIONS 2		
	REVISIONS 3	REVISIONS 4		
	FIELD CHANGES			
DEXTER ROUTE 7 CROSS SECTIONS				
SHEET NUMBER <b>139</b> OF 15				



Date: 5/19/2014

Username: Alee.Mousseau

Division: HIGHWAY

Filename: ... \140\_XSECT\_201+25\_107.dgn

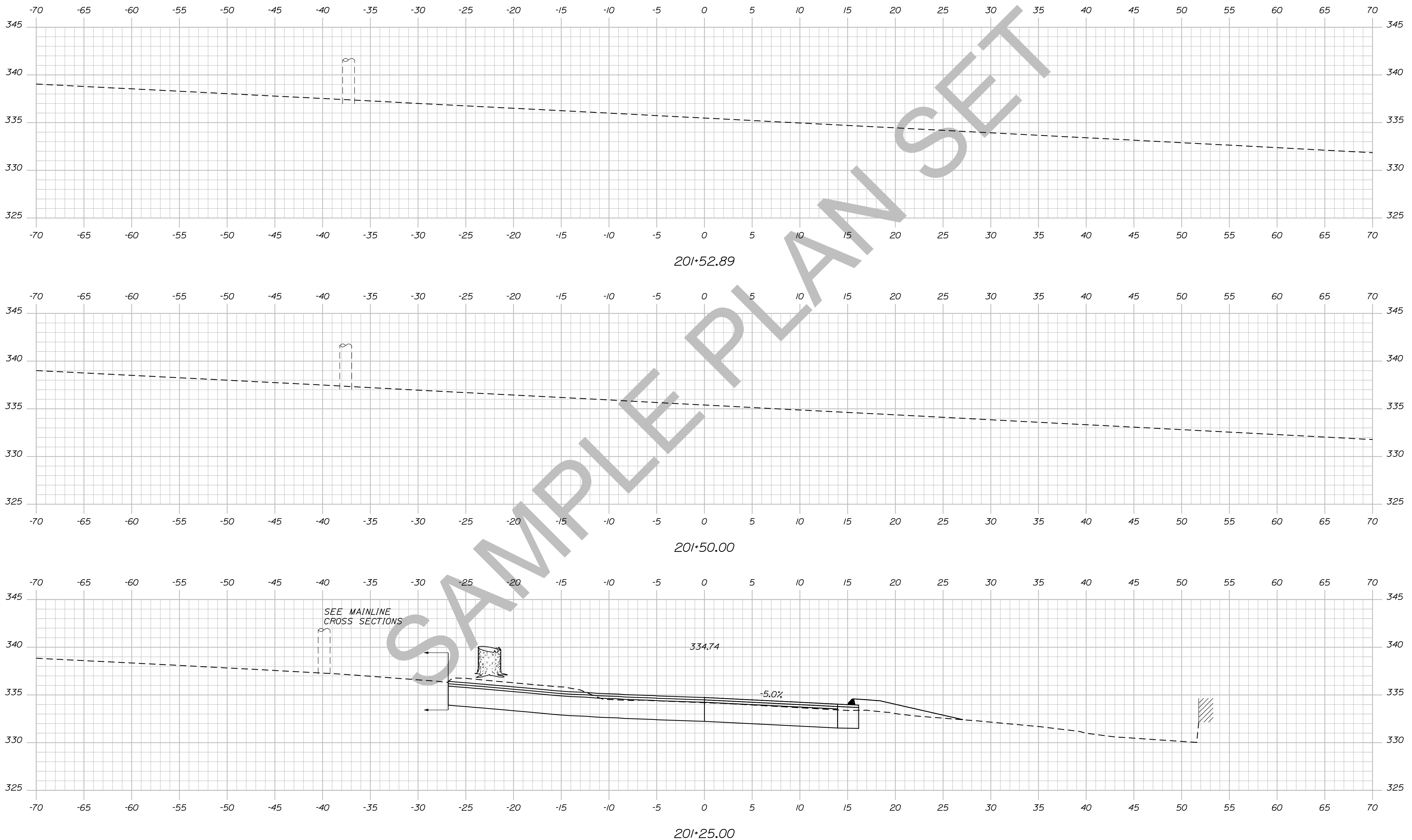

STATE OF MAINE  
DEPARTMENT OF TRANSPORTATION  
018246.00  
PIN  
18246.00  
HIGHWAY PLANS

PROJ. MANAGER	ERNEST MARTIN	BY	DATE
CHECKED-REVIEWED	TRAVIS WOLFE		
DESIGNS DET AILED		SIGNATURE	
REVISIONS 1		P.E. NUMBER	
REVISIONS 2		DATE	
REVISIONS 3			
REVISIONS 4			
FIELD CHANGES			

DEXTER  
ROUTE 7  
CROSS SECTIONS

SHEET NUMBER  
**140**  
OF 15

Username: Alee.Mousseau

Date: 5/19/2014

Division: HIGHWAY

Filename: ... \141\_XSECT\_250+00\_108.dgn

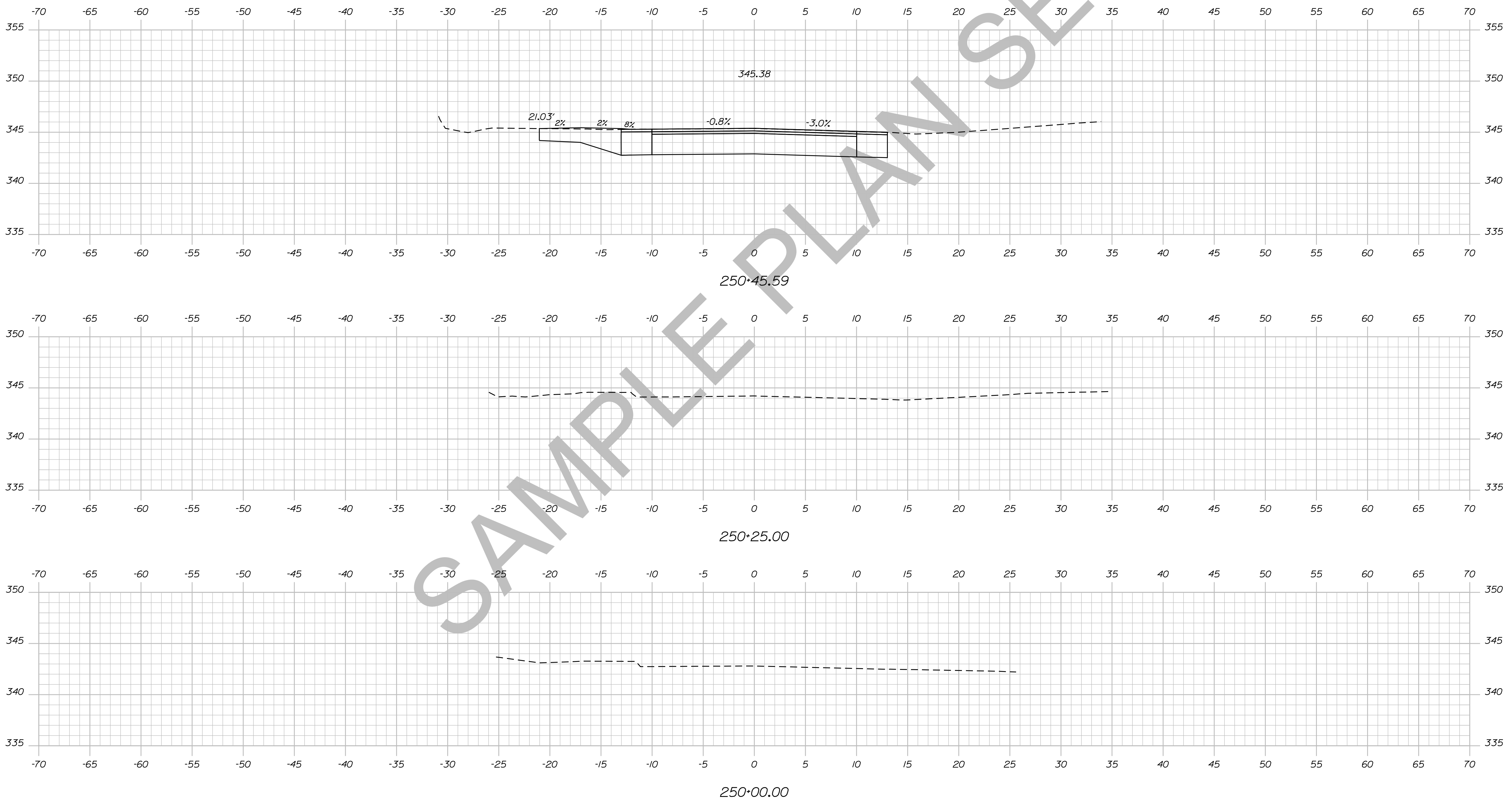

STATE OF MAINE  
DEPARTMENT OF TRANSPORTATION  
018246.00  
PIN  
18246.00  
HIGHWAY PLANS

SIGNATURE  
P.E. NUMBER  
DATE

PROJ. MANAGER	BY	DATE
ERNEST MARTIN	TRAVIS WHEEL	
DESIGN-DETAILED		
CHECKED-REVIEWED		
DESIGN-DETAILED		
DESIGN-DETAILED		
REVISIONS 1		
REVISIONS 2		
REVISIONS 3		
REVISIONS 4		
FIELD CHANGES		

DEXTER  
ROUTE 7  
CROSS SECTIONS

SHEET NUMBER  
**141**  
OF 15

Date: 5/19/2014

Username: Alee.Mousseau

Division: HIGHWAY

Filename: ... \142\_XSECT\_250+50.dgn

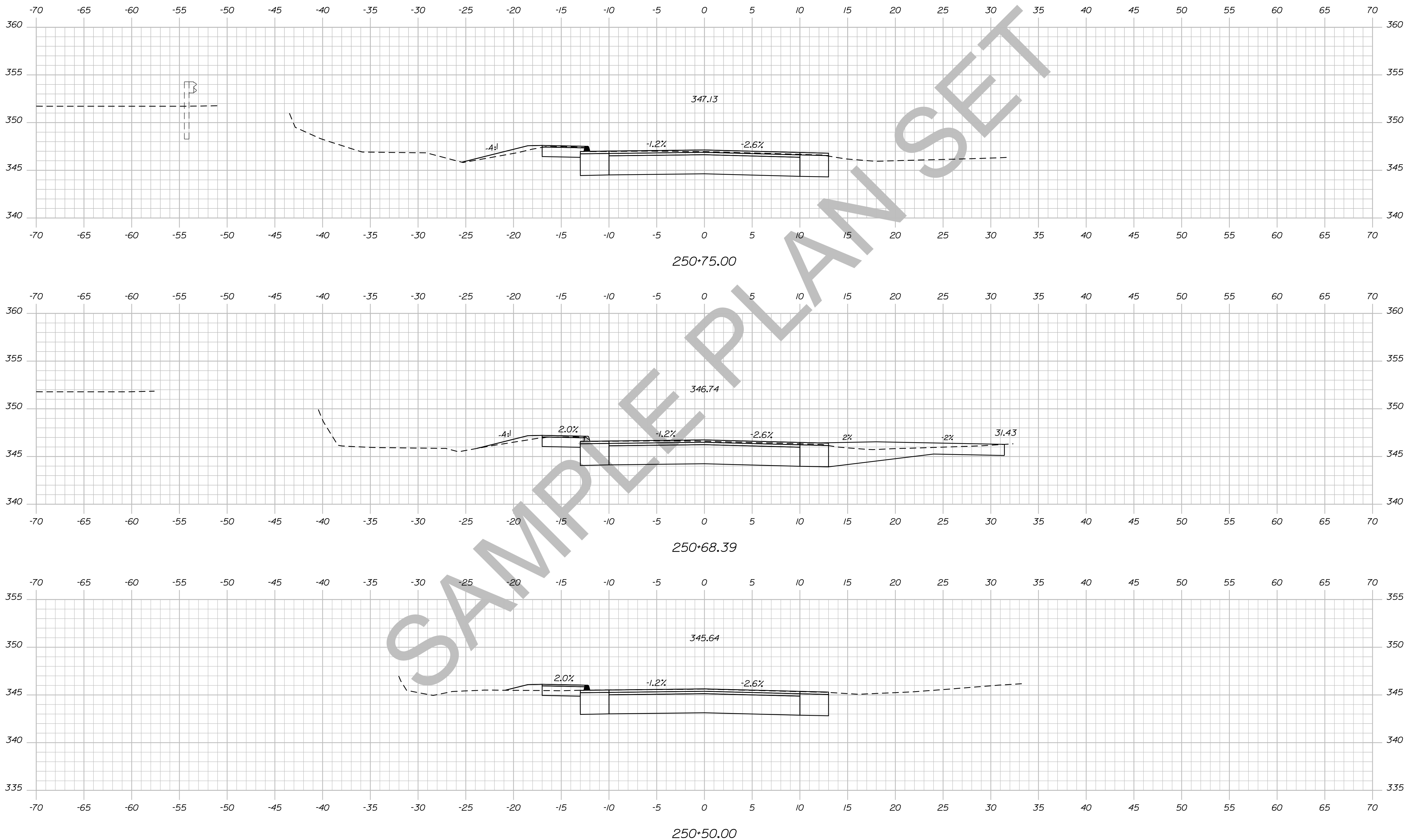

STATE OF MAINE DEPARTMENT OF TRANSPORTATION		018246.00		PIN 18246.00		HIGHWAY PLANS	
PROJ. MANAGER	ERNEST MARTIN	BY	DATE	SIGNATURE	P.E. NUMBER	DATE	
DESIGN-DETAILED	TRAVIS WOLFE						
CHECKED-REVIEWED							
DESIGN-DETAILED							
DESIGN-DETAILED							
REVISIONS 1							
REVISIONS 2							
REVISIONS 3							
REVISIONS 4							
FIELD CHANGES							
DEXTER ROUTE 7				CROSS SECTIONS			
SHEET NUMBER				142			
				OF 15			

Date: 5/19/2014

Username: Alee.Mousseau

Division: HIGHWAY

Filename: ... \143\_XSECT\_251+00\_110.dgn

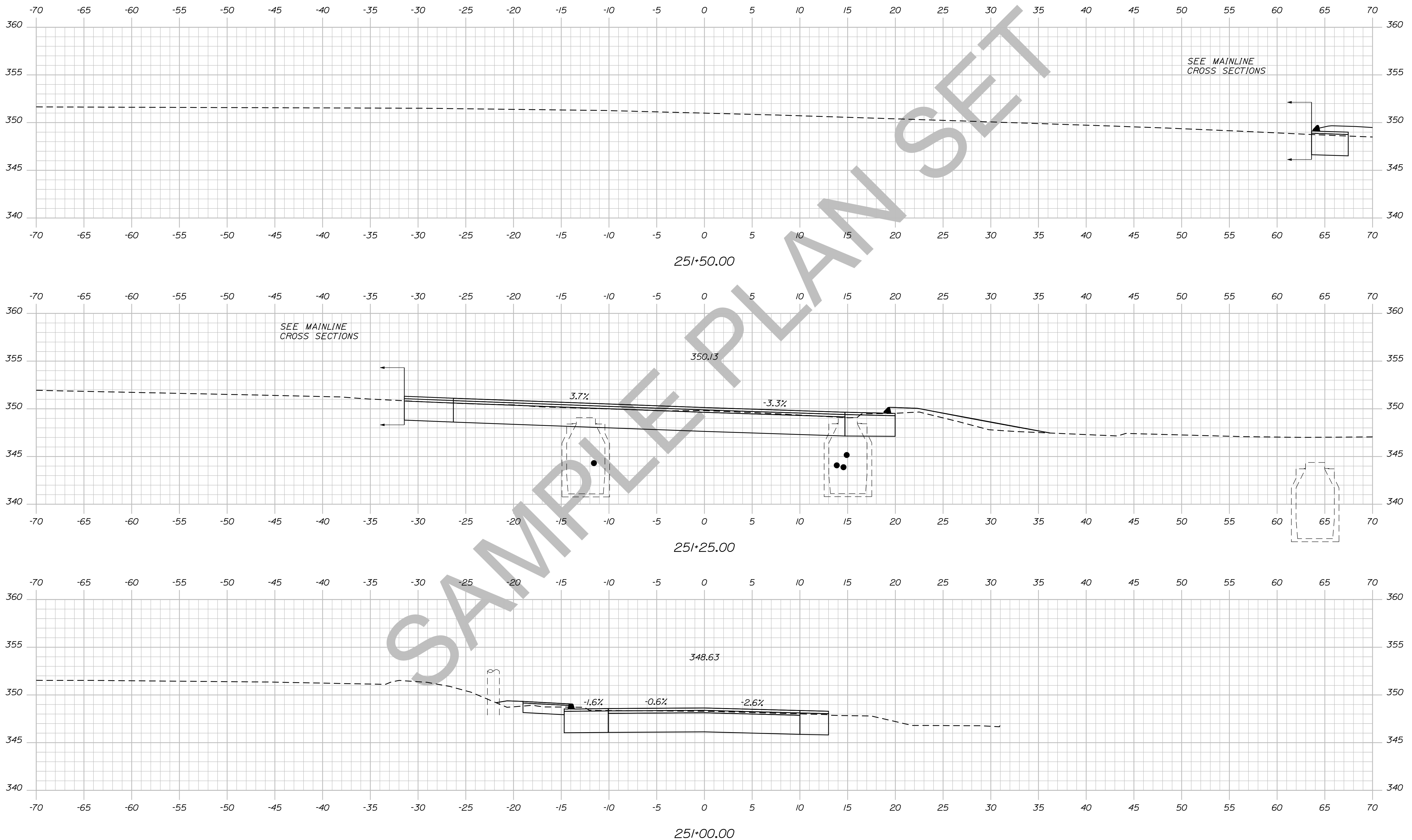

STATE OF MAINE DEPARTMENT OF TRANSPORTATION		018246.00	PIN 18246.00	HIGHWAY PLANS
	SIGNATURE	P.E. NUMBER	DATE	
PROJ. MANAGER ERNEST MARTIN	BY TRAVIS WHEL			
DESIGN-DETAILED	CHECKED-REVIEWED	DESIGNS-DETAILED	REVISIONS 1	REVISIONS 2
DESIGNS-DETAILED	REVISIONS 3	REVISIONS 4	FIELD CHANGES	
DEXTER ROUTE 7		CROSS SECTIONS		
SHEET NUMBER				
143				
OF 15				

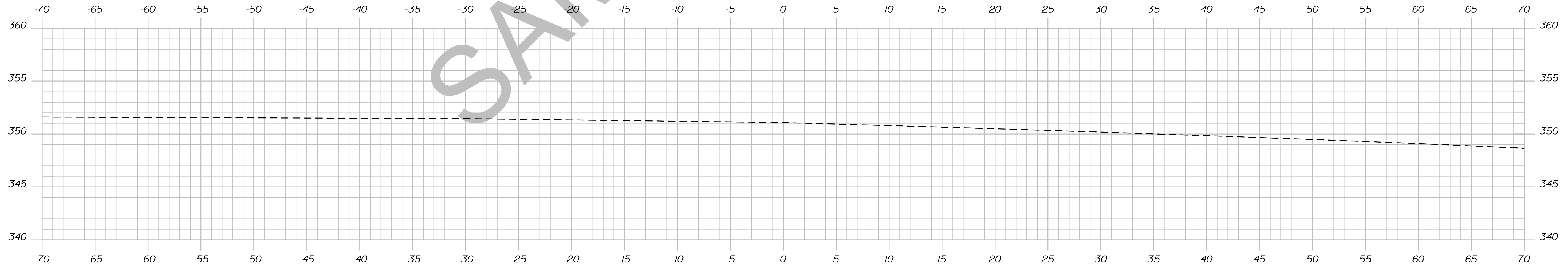

251+52.03

SAMPLE PLAN SET

STATE OF MAINE  
DEPARTMENT OF TRANSPORTATION

018246.00

PIN

18246.00

HIGHWAY PLANS

SIGNATURE

P.E. NUMBER

DATE

DATE

PROJ. MANAGER ERNEST MARTIN

CHECKED-REVIEWED

DESIGNS-DETAILED

REVISIONS 1

REVISIONS 2

REVISIONS 3

REVISIONS 4

FIELD CHANGES

BY

TRAVIS WEL

DATE

DEXTER  
ROUTE 7

CROSS SECTIONS

SHEET NUMBER

144

OF 15

Date: 5/19/2014

Username: Alee.Mousseau

Division: HIGHWAY

Filename: ... \145\_XSECT\_300+00\_112.dgn

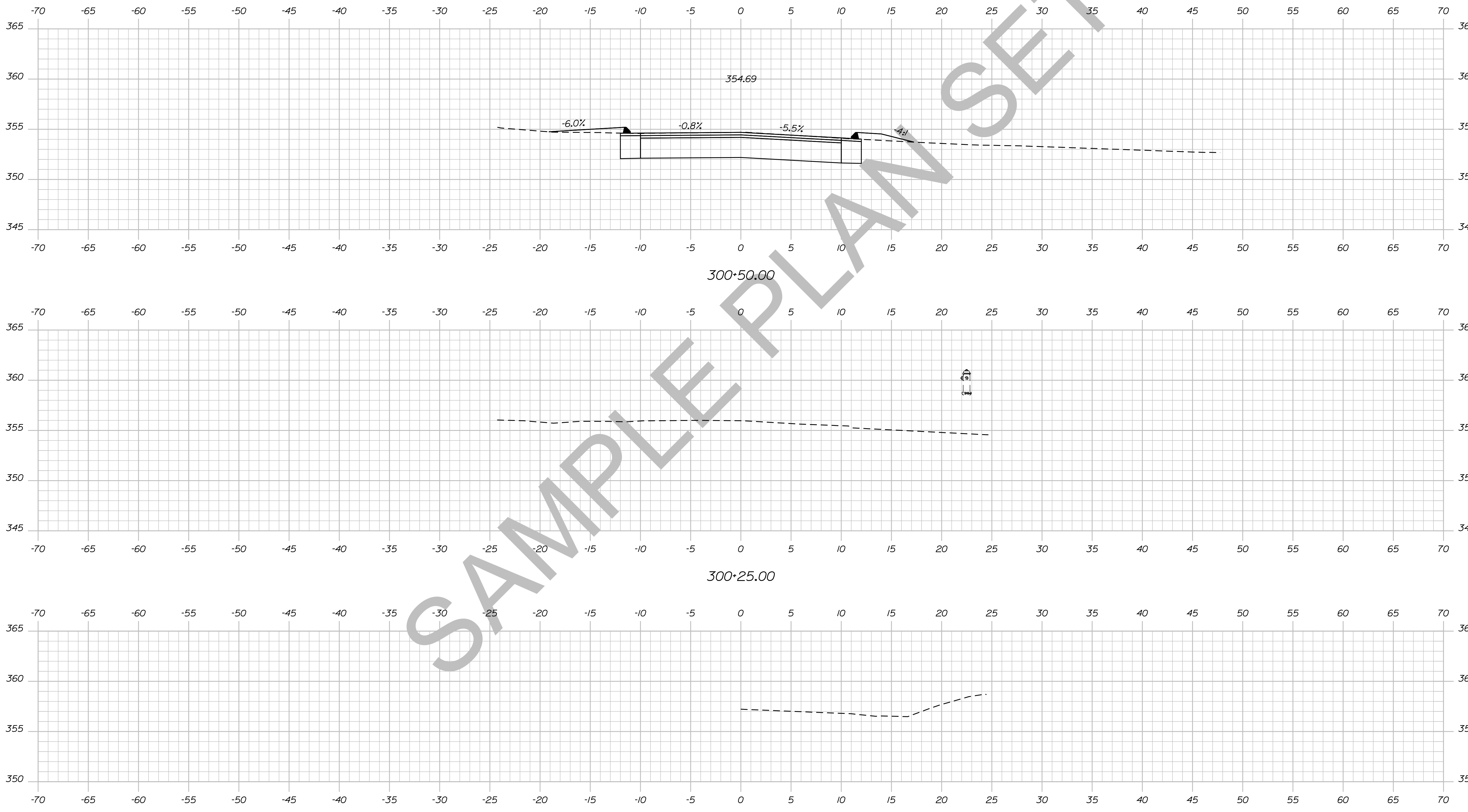

STATE OF MAINE  
DEPARTMENT OF TRANSPORTATION  
018246.00  
PIN  
18246.00  
HIGHWAY PLANS

SIGNATURE  
P.E. NUMBER  
DATE

PROJ. MANAGER	ERNEST MARTIN	BY	DATE
DESIGN-DETAILED	TRAVIS WEL		
CHECKED-REVIEWED			
DESIGN-DETAILED			
DESIGN-DETAILED			
REVISIONS 1			
REVISIONS 2			
REVISIONS 3			
REVISIONS 4			
FIELD CHANGES			

DEXTER  
ROUTE 7  
CROSS SECTIONS

SHEET NUMBER  
145  
OF 15



Date: 5/19/2014

Username: Allee.Mousseau

Division: HIGHWAY

Filename: ... \146\_XSECT\_300+75\_113.dgn

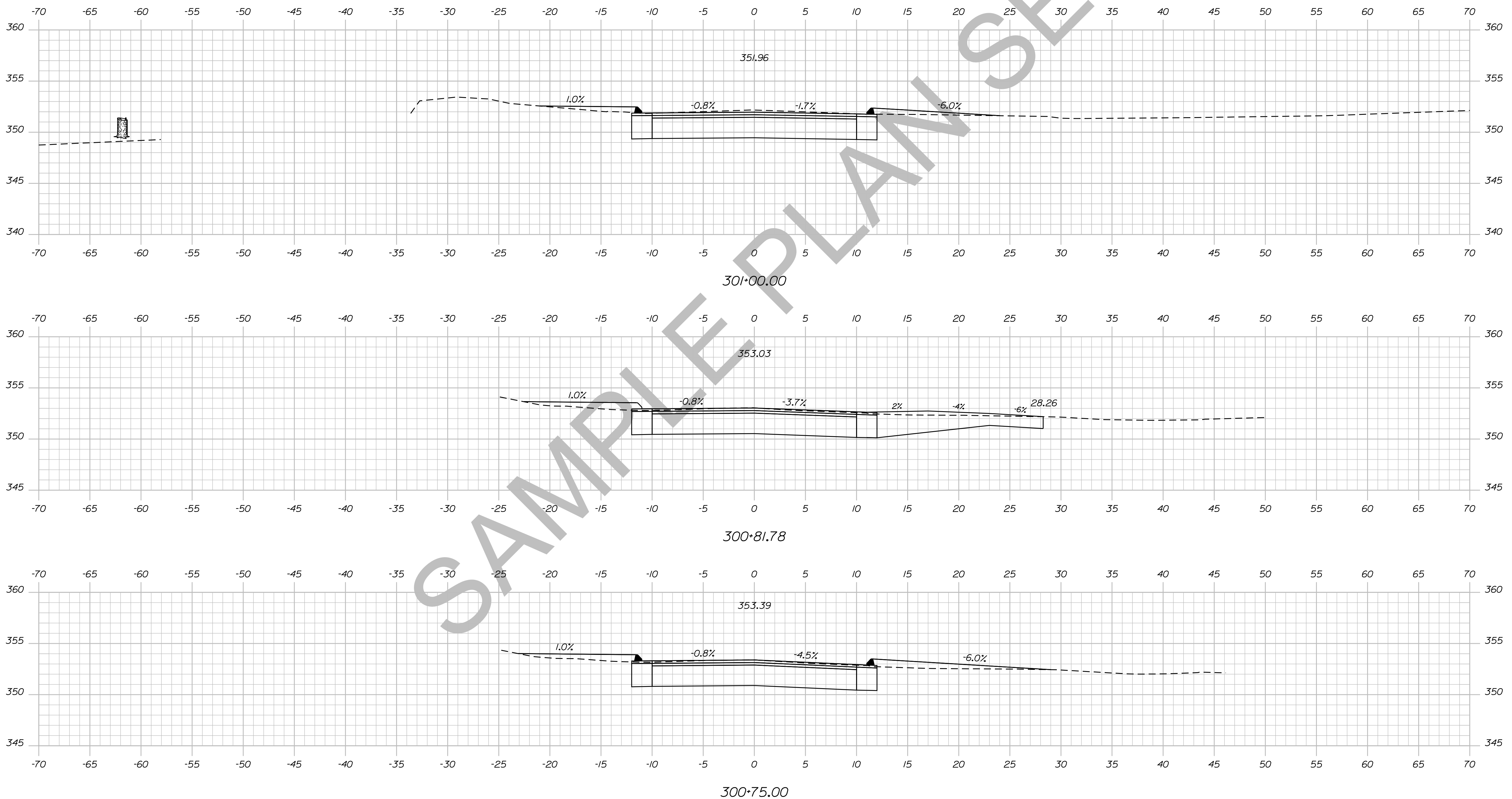

STATE OF MAINE  
DEPARTMENT OF TRANSPORTATION  
018246.00  
PIN  
18246.00  
HIGHWAY PLANS

PROJ. MANAGER	BY	DATE	SIGNATURE
ERNEST MARTIN	TRAVIS WHEELER		
DESIGN-DETAILED			
CHECKED-REVIEWED			
DESIGN-DETAILED			
DESIGN-DETAILED			
REVISIONS 1			
REVISIONS 2			
REVISIONS 3			
REVISIONS 4			
FIELD CHANGES			

DEXTER  
ROUTE 7  
CROSS SECTIONS

SHEET NUMBER  
**146**  
OF 15

Date: 5/19/2014

Username: Alee.Mousseau

Division: HIGHWAY

Filename: ... \147\_XSECT\_301+25\_114.dgn

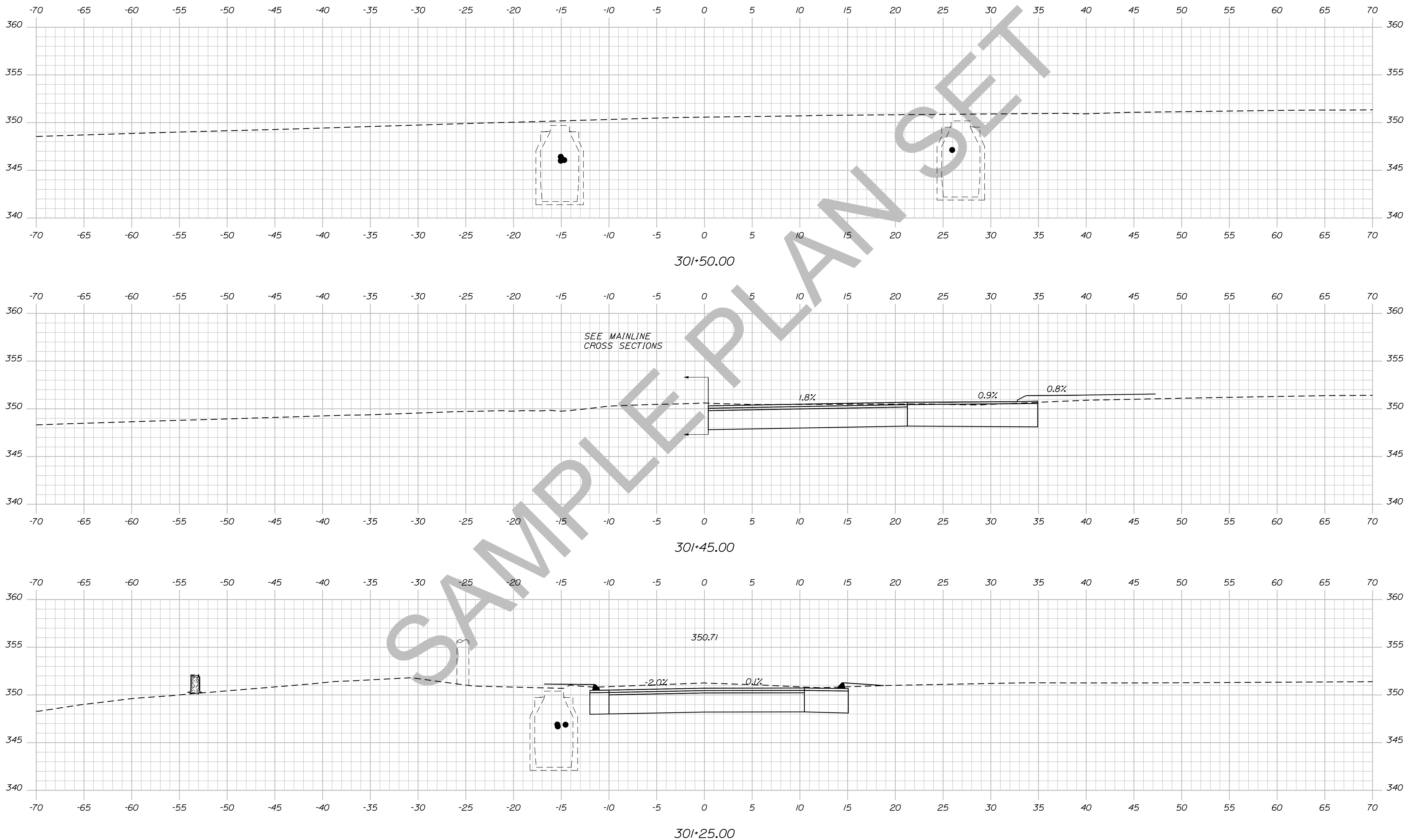

STATE OF MAINE  
DEPARTMENT OF TRANSPORTATION  
018246.00  
PIN 18246.00  
HIGHWAY PLANS

PROJ. MANAGER	BY	DATE	SIGNATURE	P.E. NUMBER	DATE
ERNEST MARTIN	TRAVIS WHEL				
DESIGN-DETAILED					
CHECKED-REVIEWED					
DESIGN-DETAILED					
DESIGN-DETAILED					
REVISIONS 1					
REVISIONS 2					
REVISIONS 3					
REVISIONS 4					
FIELD CHANGES					

DEXTER  
ROUTE 7  
CROSS SECTIONS

SHEET NUMBER  
**147**  
OF 15

Date: 5/19/2014

Username: Allee.Mousseau

Division: HIGHWAY

Filename: ... \148\_XSECT\_352+00\_115.dgn

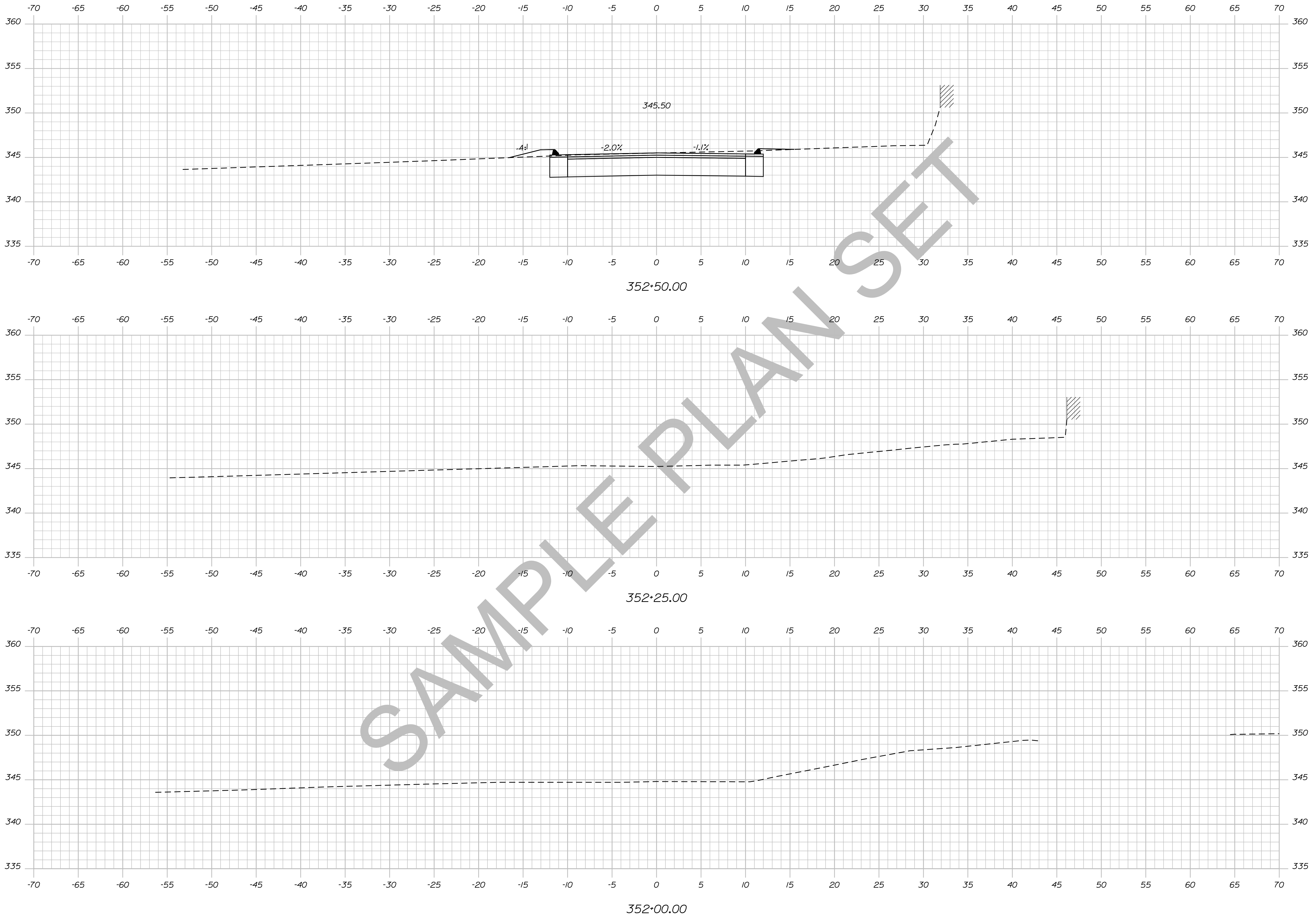

STATE OF MAINE  
 DEPARTMENT OF TRANSPORTATION  
 018246-00  
 PIN 18246.00  
 HIGHWAY PLANS

PROJ. MANAGER	ERNEST MARTIN	BY	DATE
DESIGN-DETAILED	TRAVIS WOLFE		
CHECKED-REVIEWED			
DESIGN-DET AILED			
DESIGN-DET AILED			
REVISIONS 1			
REVISIONS 2			
REVISIONS 3			
REVISIONS 4			
FIELD CHANGES			

DEXTER  
 ROUTE 7  
 CROSS SECTIONS

SHEET NUMBER  
**148**  
 OF 15

Date: 5/19/2014

Username: Alee.Mousseau

Division: HIGHWAY

Filename: ... \149\_XSECT\_352+75\_116.dgn

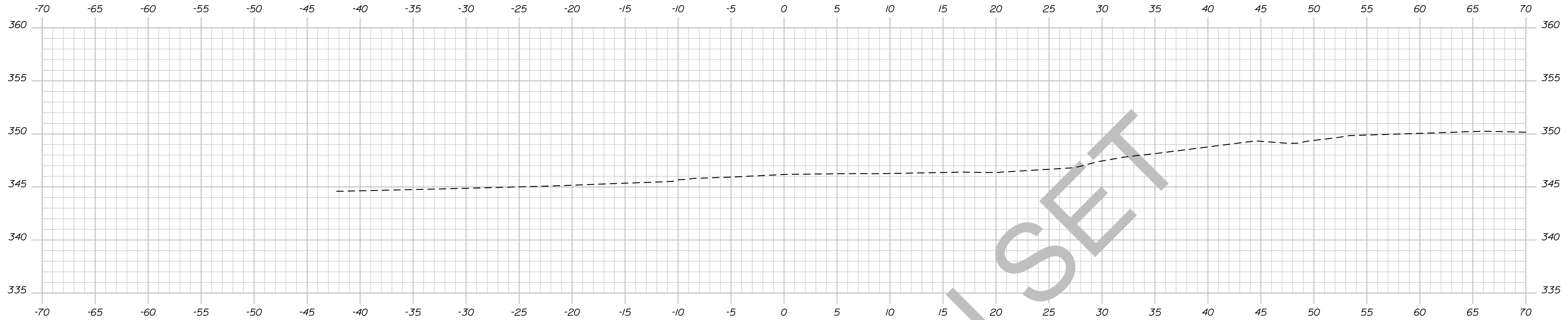

353+25.00

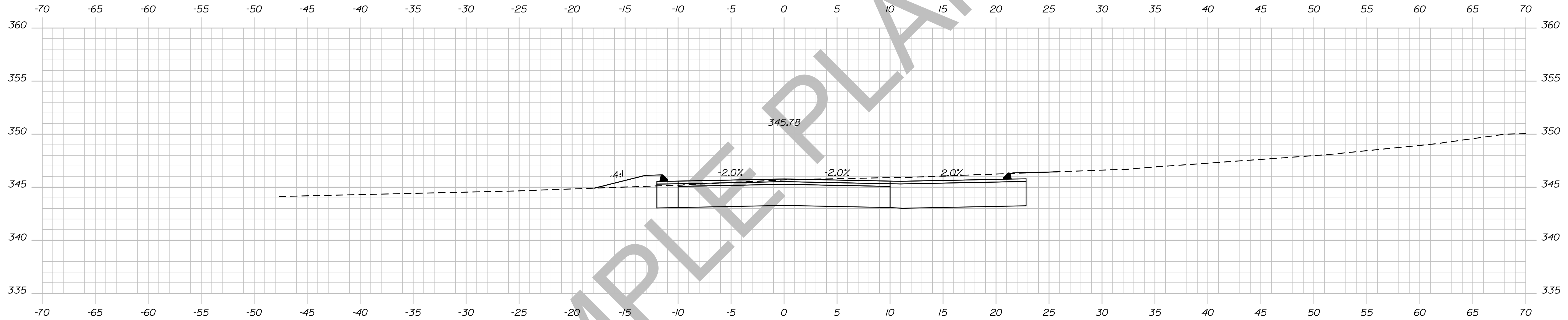

353+00.00

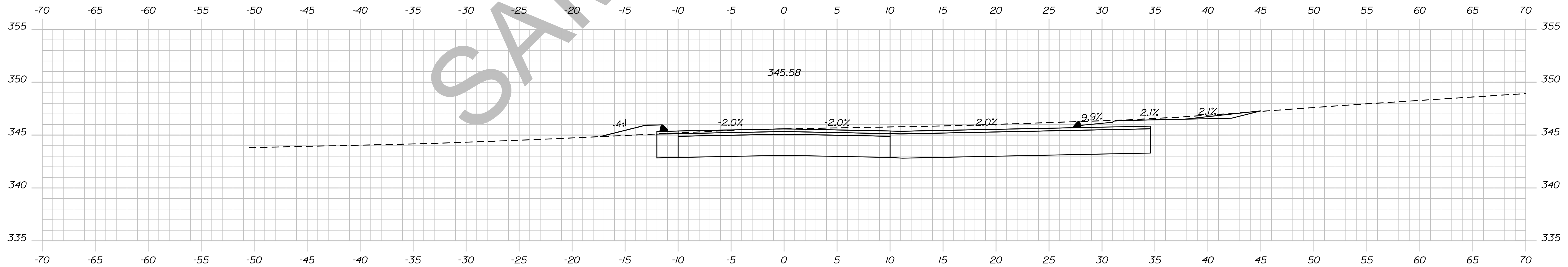

352+75.00

STATE OF MAINE  
DEPARTMENT OF TRANSPORTATION

018246.00

PIN  
18246.00

HIGHWAY PLANS

SIGNATURE

P.E. NUMBER

DATE

PROJ. MANAGER ERNEST MARTIN  
CHECKED-REVIEWED TRAVIS WELT

DESIGN DETAILED  
DESIGN DETAILED  
DESIGN DETAILED  
REVISIONS 1  
REVISIONS 2  
REVISIONS 3  
REVISIONS 4

DATE  
DATE  
DATE  
DATE  
DATE  
DATE  
DATE  
DATE

FIELD CHANGES

DEXTER  
ROUTE 7

CROSS SECTIONS

SHEET NUMBER

149

OF 15

Date: 5/19/2014

Username: Alee.Mousseau

Division: HIGHWAY

Filename: ... \150\_XSECT\_402+84\_117.dgn

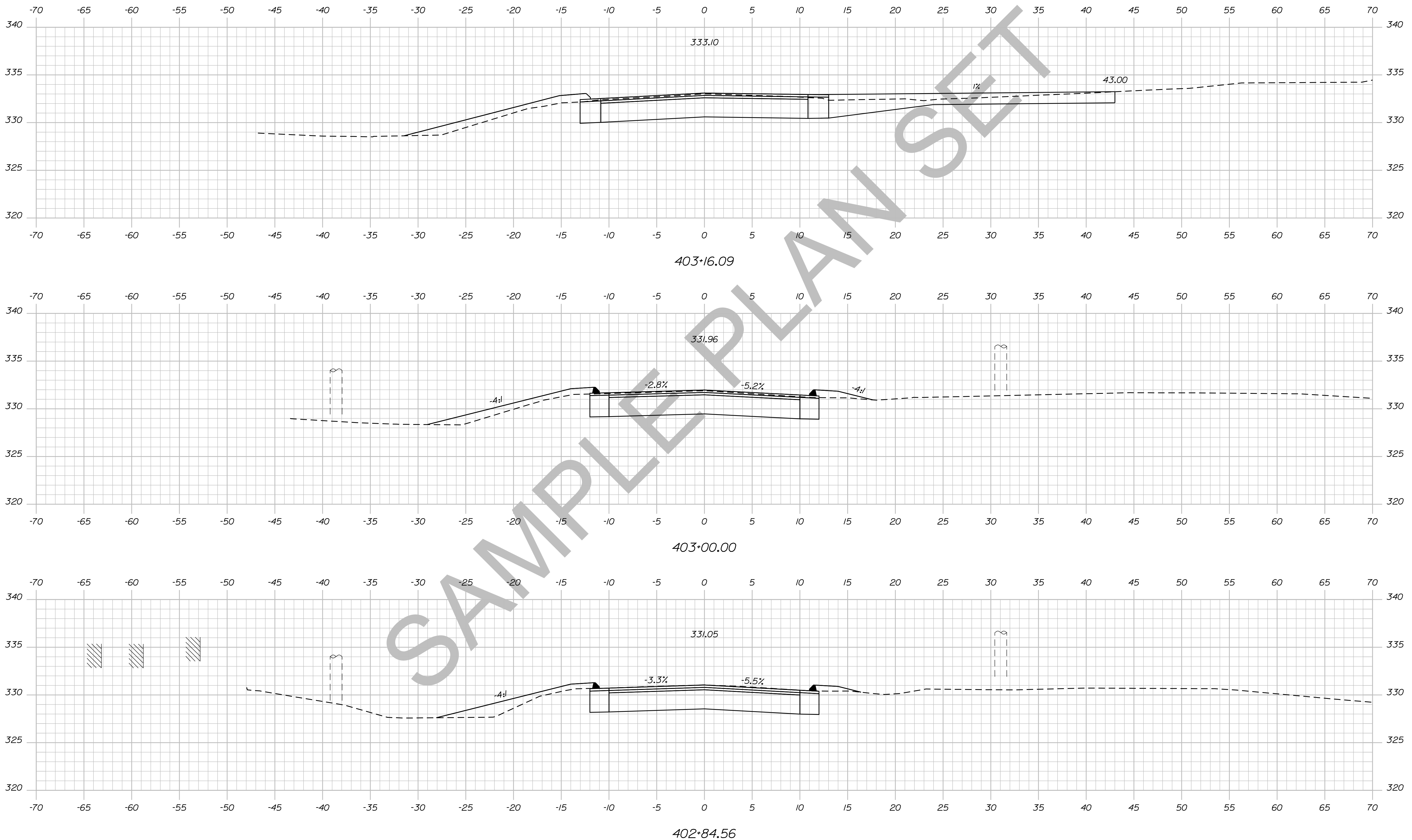

STATE OF MAINE  
DEPARTMENT OF TRANSPORTATION  
018246.00  
PIN  
18246.00  
HIGHWAY PLANS

PROJ. MANAGER	ERNEST MARTIN	BY	DATE
CHECKED-REVIEWED	TRAVIS WHEL		
DESIGN-DETAILED			
DESIGN-DETAILED			
REVISIONS 1			
REVISIONS 2			
REVISIONS 3			
REVISIONS 4			
FIELD CHANGES			

DEXTER  
ROUTE 7  
CROSS SECTIONS

SHEET NUMBER  
**150**  
OF 15

Date: 5/19/2014

Username: Allee.Mousseau

Division: HIGHWAY

Filename: ... \151\_XSECT\_403+25\_118.dgn

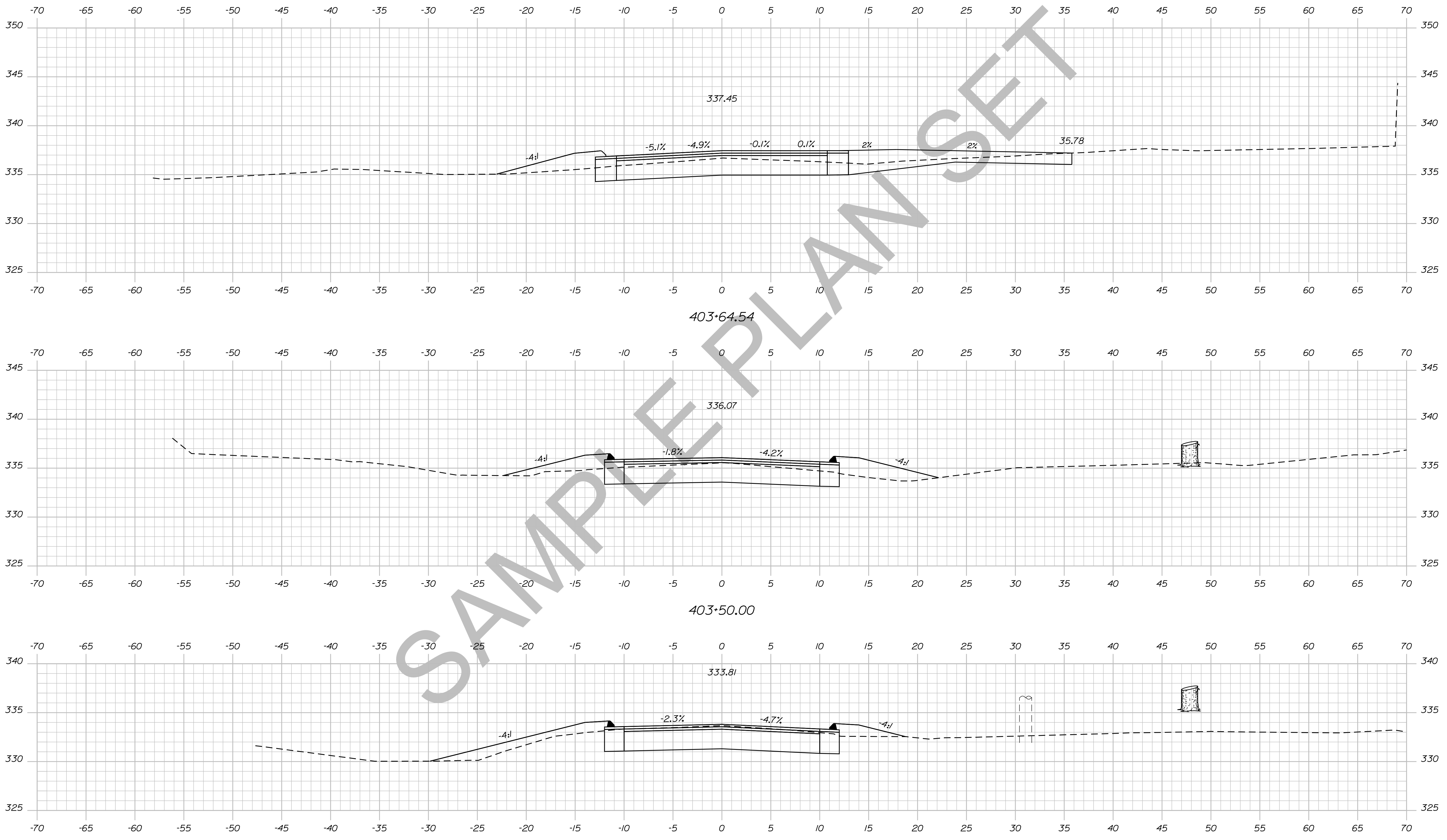

STATE OF MAINE  
DEPARTMENT OF TRANSPORTATION  
018246.00  
PIN  
18246.00  
HIGHWAY PLANS

PROJ. MANAGER	BY	DATE	SIGNATURE	P.E. NUMBER	DATE
ERNEST MARTIN	TRAVIS WOLFE				
DESIGN-DETAILED					
CHECKED-REVIEWED					
DESIGN-DETAILED					
DESIGN-DETAILED					
REVISIONS 1					
REVISIONS 2					
REVISIONS 3					
REVISIONS 4					
FIELD CHANGES					

DEXTER  
ROUTE 7  
CROSS SECTIONS

SHEET NUMBER  
**151**  
OF 15

Date: 5/19/2014

Username: Allee.Mousseau

Division: HIGHWAY

Filename: ... \152\_XSECT\_403+75\_119.dgn

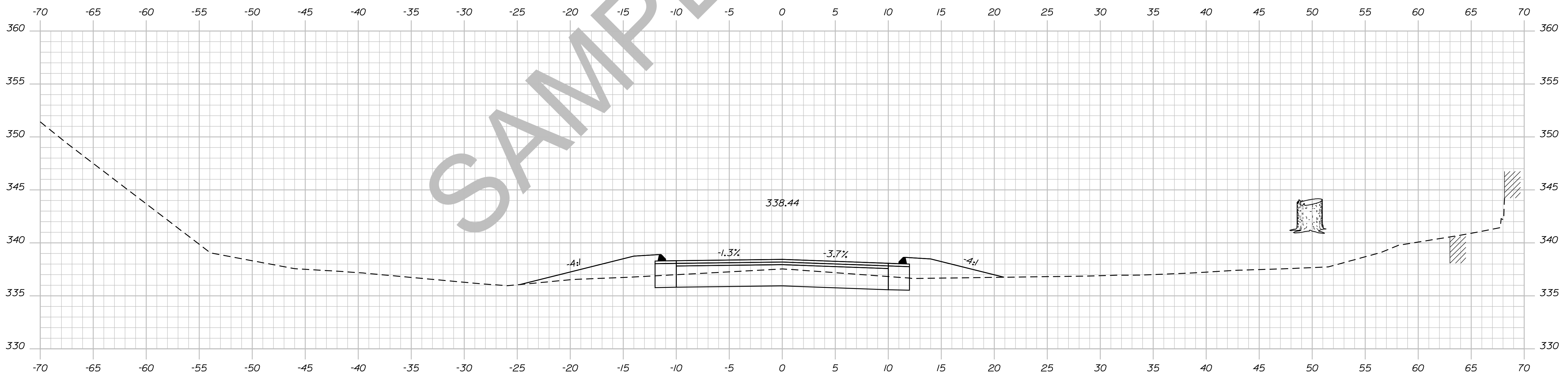
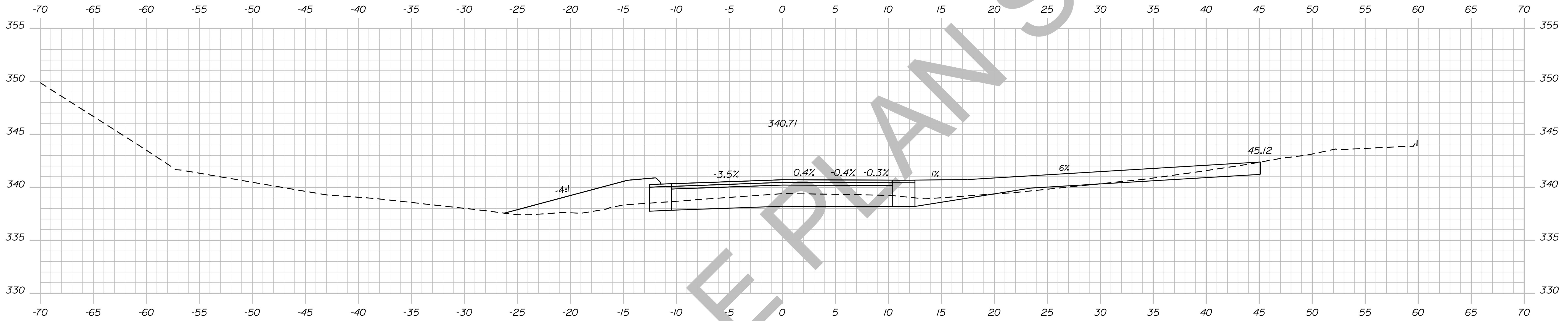

SAMPLE PLAN SET

STATE OF MAINE  
DEPARTMENT OF TRANSPORTATION

018246.00

PIN

18246.00

HIGHWAY PLANS

SIGNATURE

DATE

BY

ERNEST MARTIN

DESIGN-DETAILED

CHECKED-REVIEWED

DESIGN-DETAILED

DESIGN-DETAILED

REVISIONS 1

REVISIONS 2

REVISIONS 3

REVISIONS 4

FIELD CHANGES

DATE

P.E. NUMBER

DATE

DATE

DATE

DATE

DATE

DEXTER  
ROUTE 7  
CROSS SECTIONS

SHEET NUMBER

152

OF 15



Date: 5/19/2014

Username: Allee.Mousseau

Division: HIGHWAY

Filename: ... \153\_XSECT\_404+00\_120.dgn

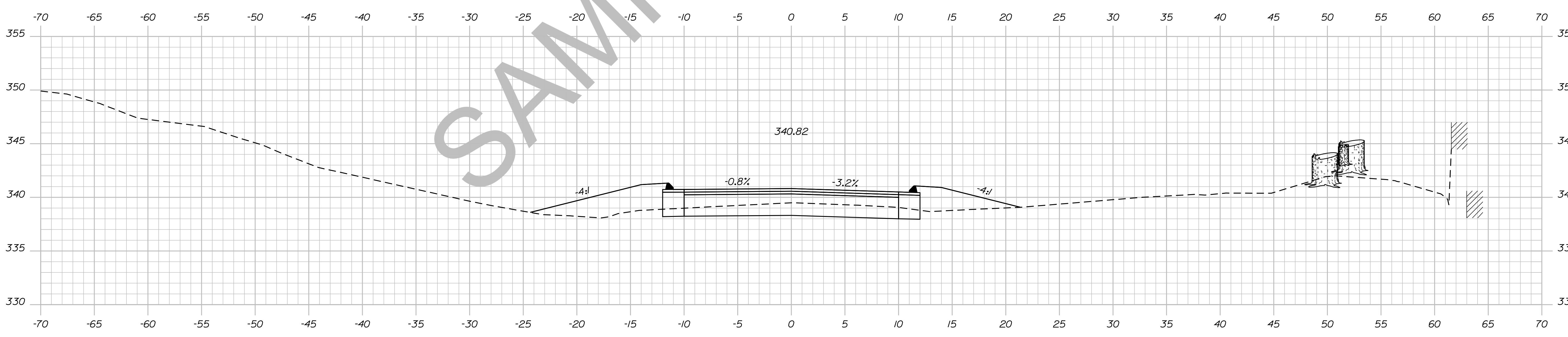
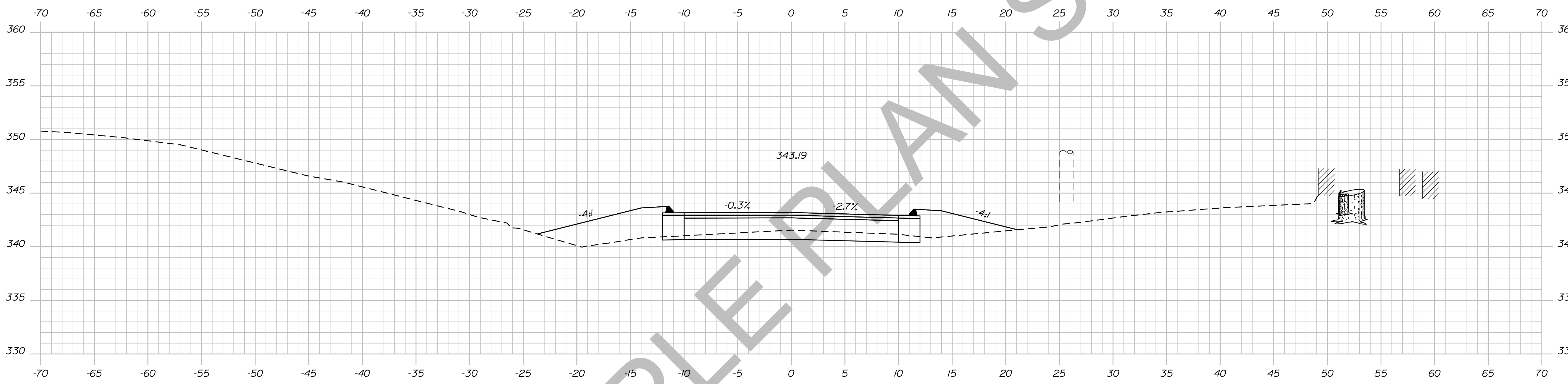

SAMPLE PLAN SET

STATE OF MAINE  
DEPARTMENT OF TRANSPORTATION  
018246.00  
PIN  
18246.00  
HIGHWAY PLANS

PROJ. MANAGER	ERNEST MARTIN	BY	DATE
DESIGN DETAILED	TRAVIS WEL		
CHECKED-REVIEWED			
DESIGN DET AILED			
DESIGN DET AILED			
REVISIONS 1			
REVISIONS 2			
REVISIONS 3			
REVISIONS 4			
FIELD CHANGES			

DEXTER  
ROUTE 7  
CROSS SECTIONS

SHEET NUMBER  
**153**  
OF 15

Date: 5/19/2014

Username: Alee.Mousseau

Division: HIGHWAY

Filename: ... \154\_XSECT\_404+50\_121.dgn

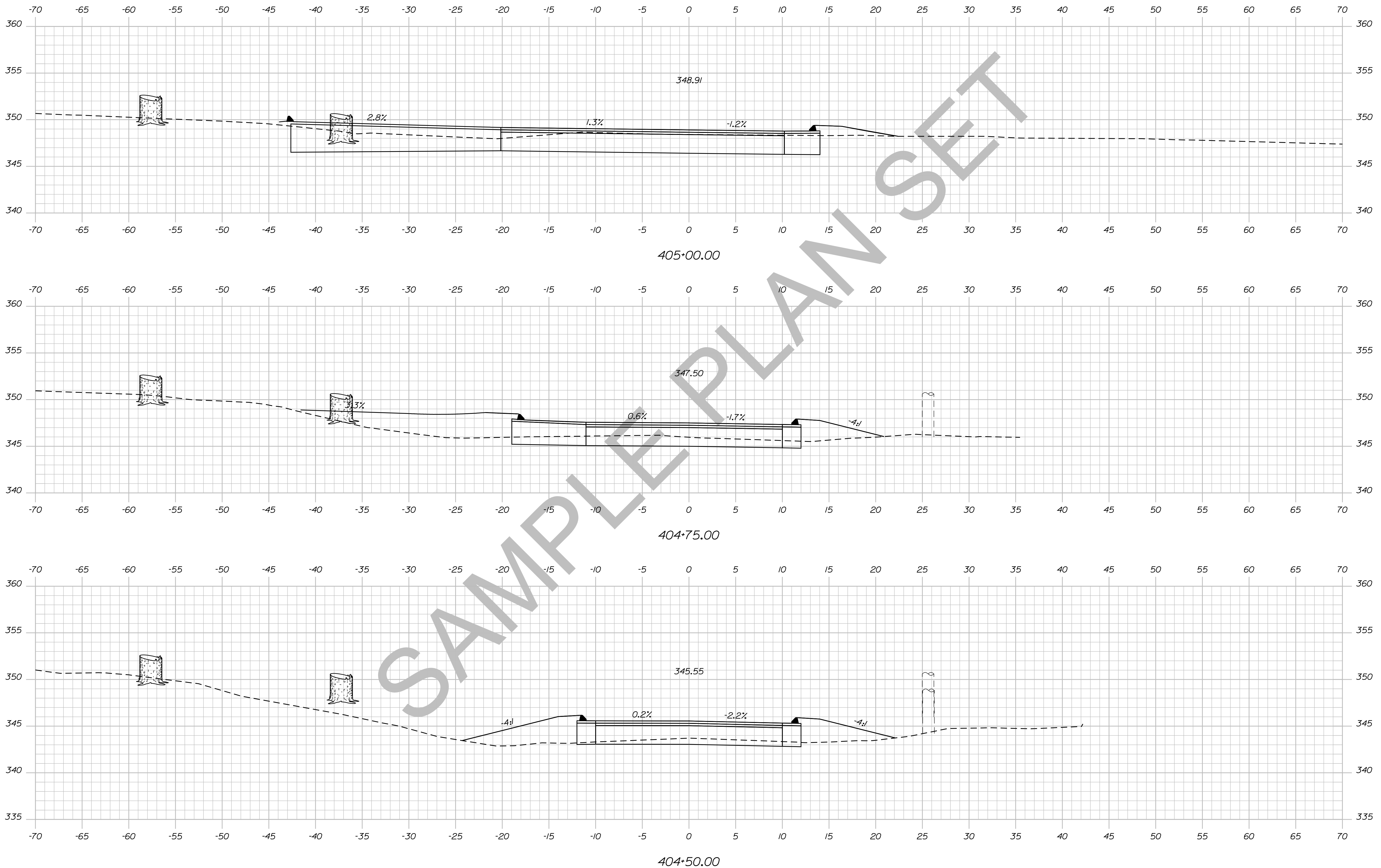

STATE OF MAINE  
DEPARTMENT OF TRANSPORTATION  
018246.00  
PIN  
18246.00  
HIGHWAY PLANS

SIGNATURE  
P.E. NUMBER  
DATE

PROJ. MANAGER	ERNEST MARTIN	BY	DATE
CHECKED-REVIEWED	TRAVIS WOLFE		
DESIGN DETAILED			
DESIGN DET AILED			
DESIGN DET AILED			
REVISIONS 1			
REVISIONS 2			
REVISIONS 3			
REVISIONS 4			
FIELD CHANGES			

DEXTER  
ROUTE 7  
CROSS SECTIONS

SHEET NUMBER  
**154**  
OF 15

Date: 5/19/2014

Username: Allee.Mousseau

Division: HIGHWAY

Filename: ... \155\_XSECT\_450+00\_122.dgn

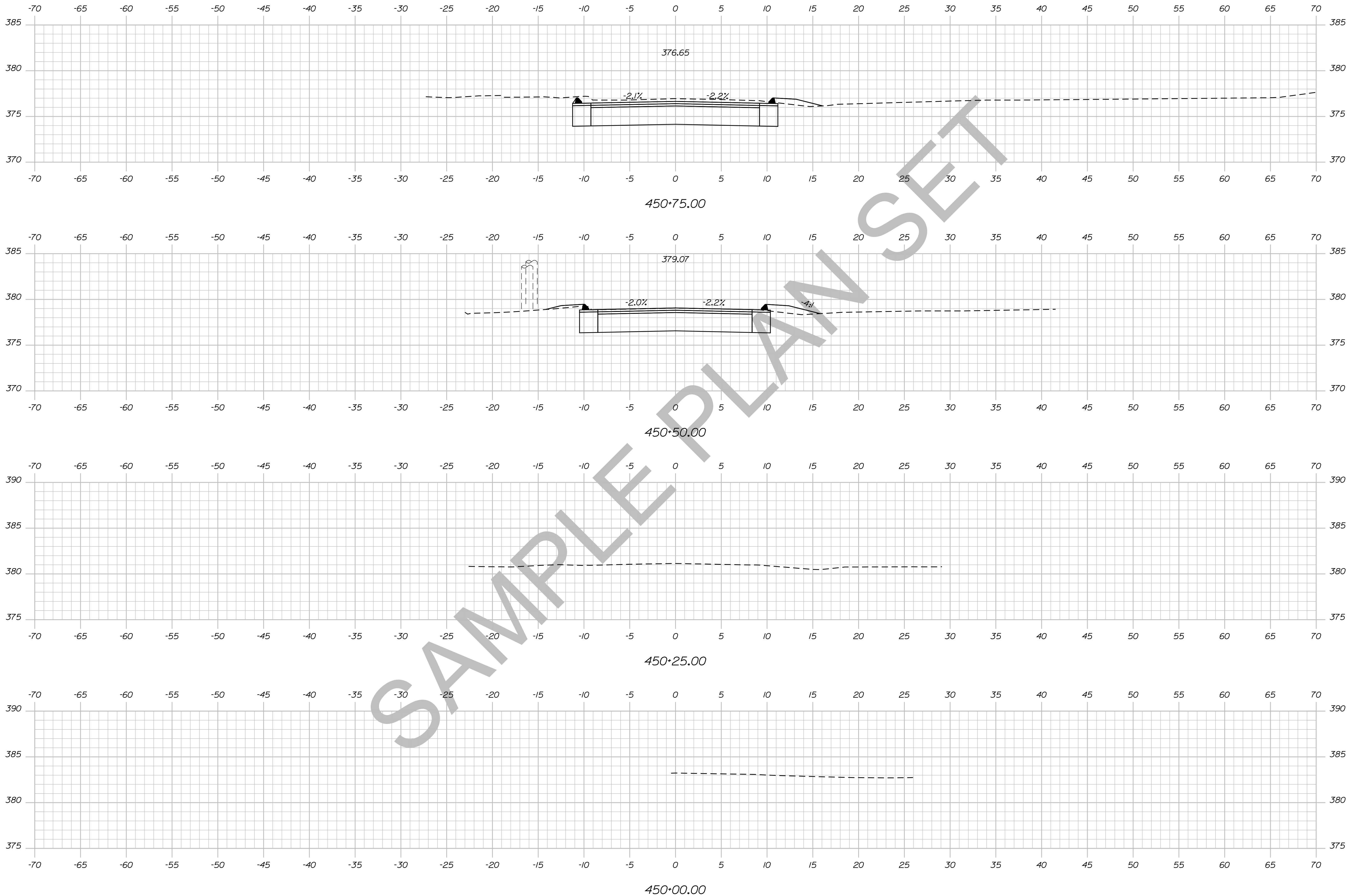

STATE OF MAINE  
DEPARTMENT OF TRANSPORTATION  
018246.00  
PIN 18246.00  
HIGHWAY PLANS

SIGNATURE  
P.E. NUMBER  
DATE

PROJ. MANAGER	BY	DATE
ERNEST MARTIN	TRAVIS WHEELER	
DESIGN-DETAILED		
CHECKED-REVIEWED		
DESIGN-DETAILED		
DESIGN-DETAILED		
REVISIONS 1		
REVISIONS 2		
REVISIONS 3		
REVISIONS 4		
FIELD CHANGES		

DEXTER  
ROUTE 7  
CROSS SECTIONS

SHEET NUMBER  
155  
OF 15

Date: 5/19/2014

Username: Allee.Mousseau

Division: HIGHWAY

Filename: ... \156\_XSECT\_451+00\_123.dgn

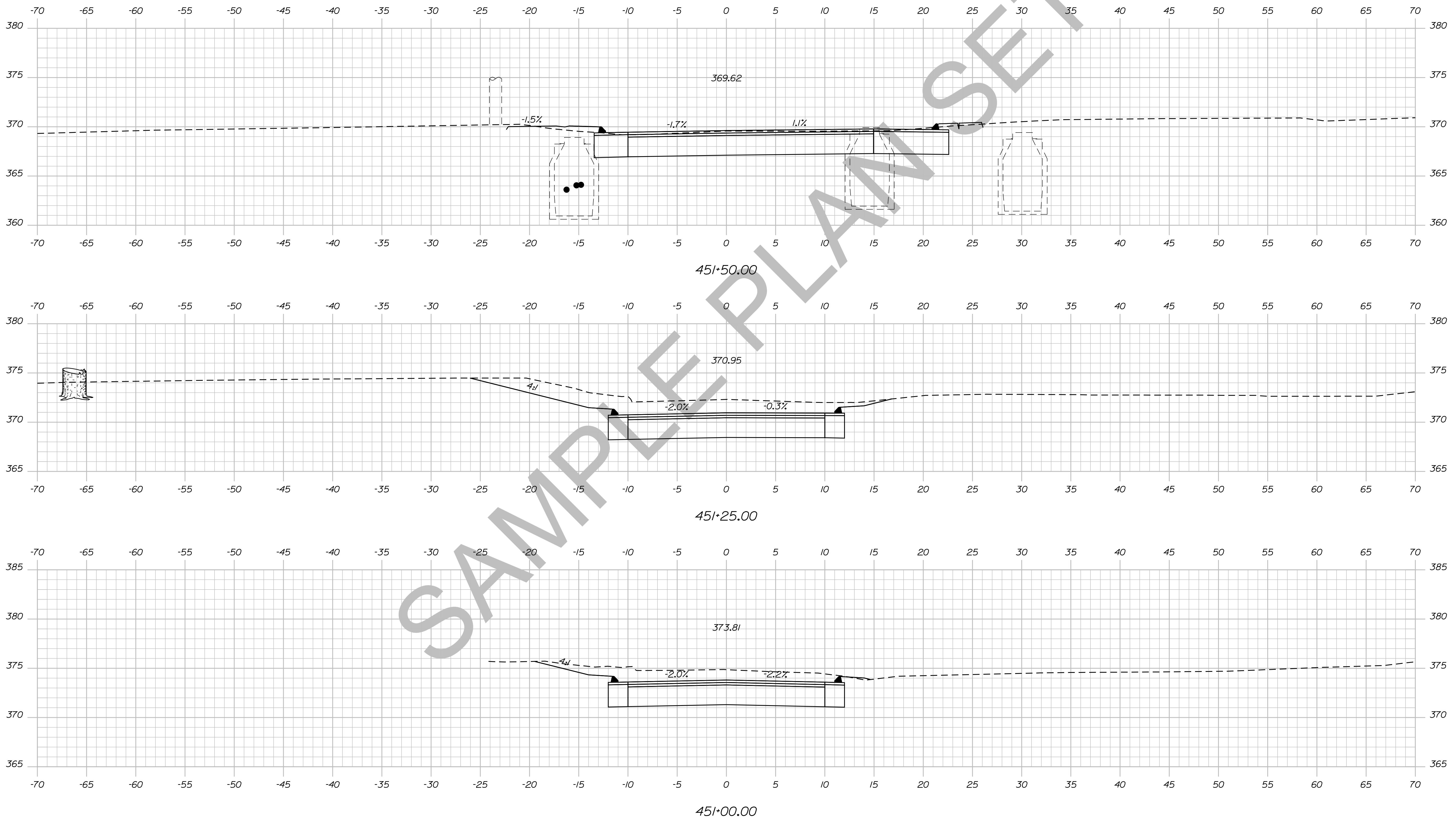

STATE OF MAINE  
DEPARTMENT OF TRANSPORTATION  
018246.00  
PIN  
18246.00  
HIGHWAY PLANS

SIGNATURE  
P.E. NUMBER  
DATE

PROJ. MANAGER	BY	DATE
ERNEST MARTIN	TRAVIS WOLFE	
DESIGN-DETAILED		
CHECKED-REVIEWED		
DESIGN-DETAILED		
DESIGN-DETAILED		
REVISIONS 1		
REVISIONS 2		
REVISIONS 3		
REVISIONS 4		
FIELD CHANGES		

DEXTER  
ROUTE 7  
CROSS SECTIONS

SHEET NUMBER  
**156**  
OF 15

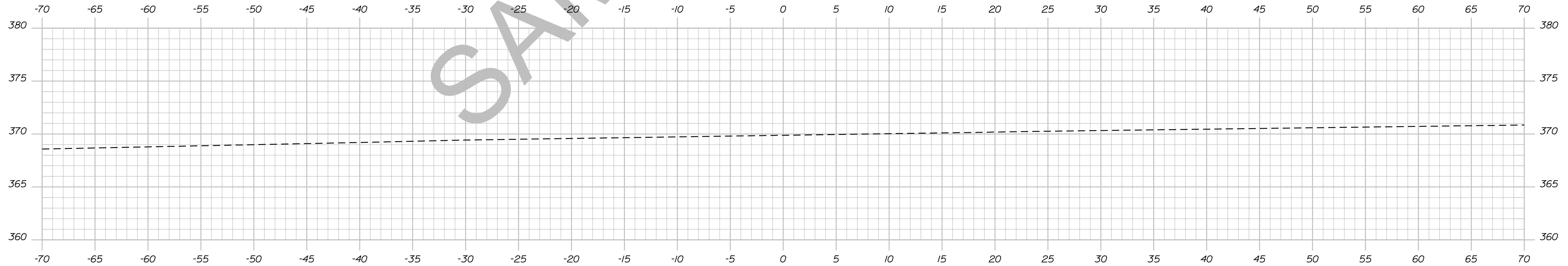

451+71.98

STATE OF MAINE  
DEPARTMENT OF TRANSPORTATION

018246.00

PIN  
18246.00

HIGHWAY PLANS

SIGNATURE

P.E. NUMBER

DATE

DATE

PROJ. MANAGER ERNEST MARTIN  
DESIGN-DETAILED TRAVIS WEL

CHECKED-REVIEWED

DESIGN-DETAILED

REVISIONS 1

REVISIONS 2

REVISIONS 3

REVISIONS 4

FIELD CHANGES

DEXTER  
ROUTE 7

CROSS SECTIONS

SHEET NUMBER

157

OF 15

Date: 5/19/2014

Username: Allee.Mousseau

Division: HIGHWAY

Filename: ... \158\_XSECT\_500+00\_125.dgn

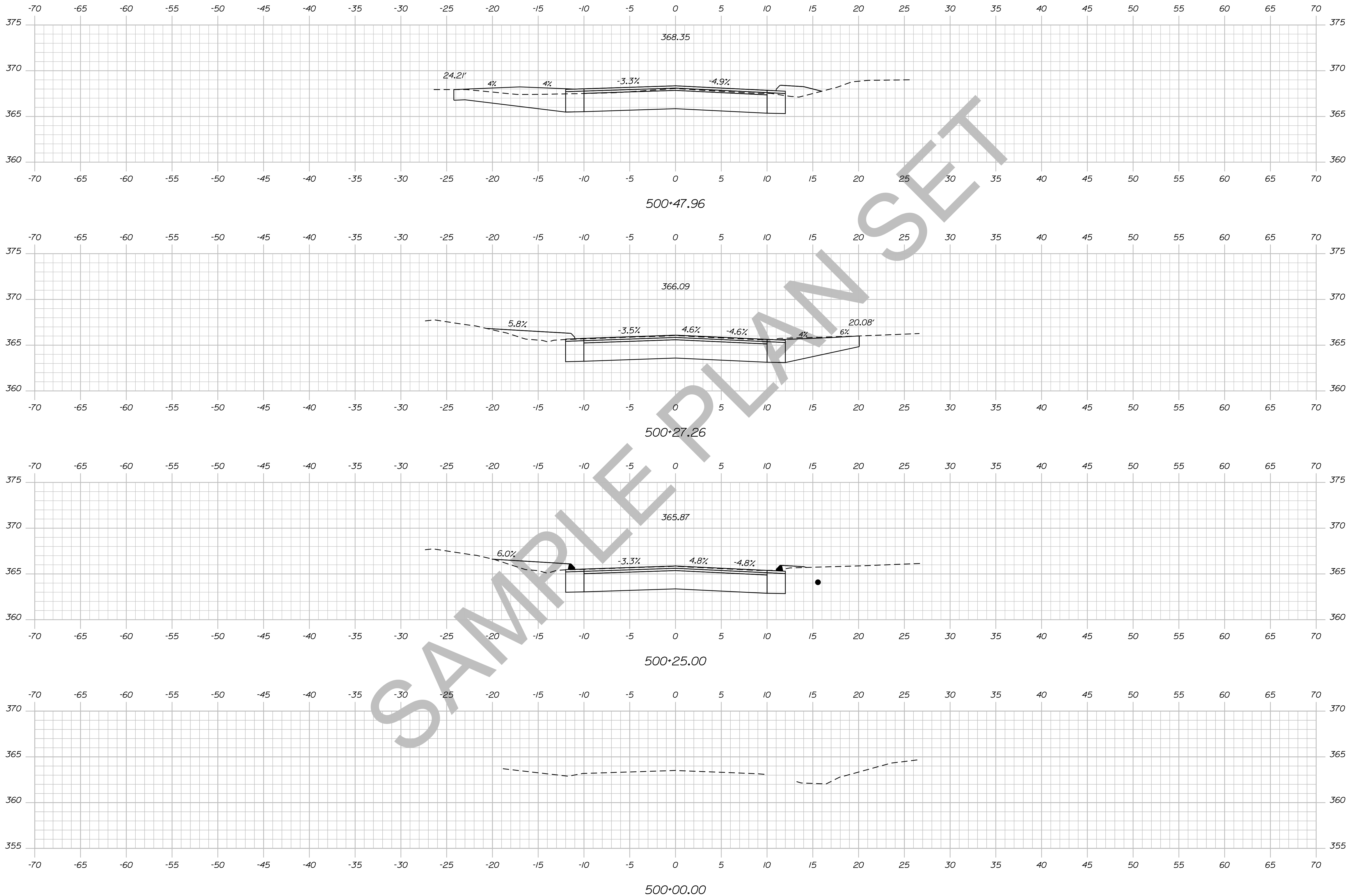

STATE OF MAINE  
DEPARTMENT OF TRANSPORTATION  
018246.00  
PIN  
18246.00  
HIGHWAY PLANS

PROJ. MANAGER	BY	DATE	SIGNATURE	P.E. NUMBER	DATE
ERNEST MARTIN	TRAVIS WHEELER				
DESIGN-DETAILED					
CHECKED-REVIEWED					
DESIGN-DETAILED					
DESIGN-DETAILED					
REVISIONS 1					
REVISIONS 2					
REVISIONS 3					
REVISIONS 4					
FIELD CHANGES					

DEXTER  
ROUTE 7  
CROSS SECTIONS

SHEET NUMBER  
**158**  
OF 15

Date: 5/19/2014

Username: Alee.Mousseau

Division: HIGHWAY

Filename: ... \159\_XSECT\_500+50\_126.dgn

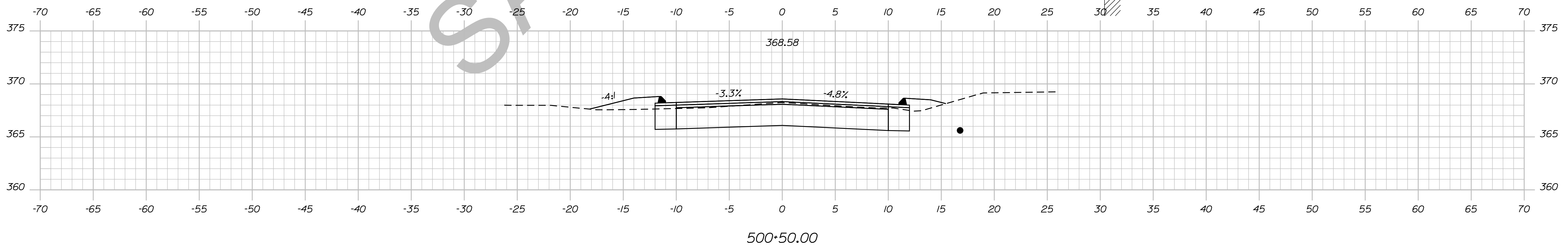
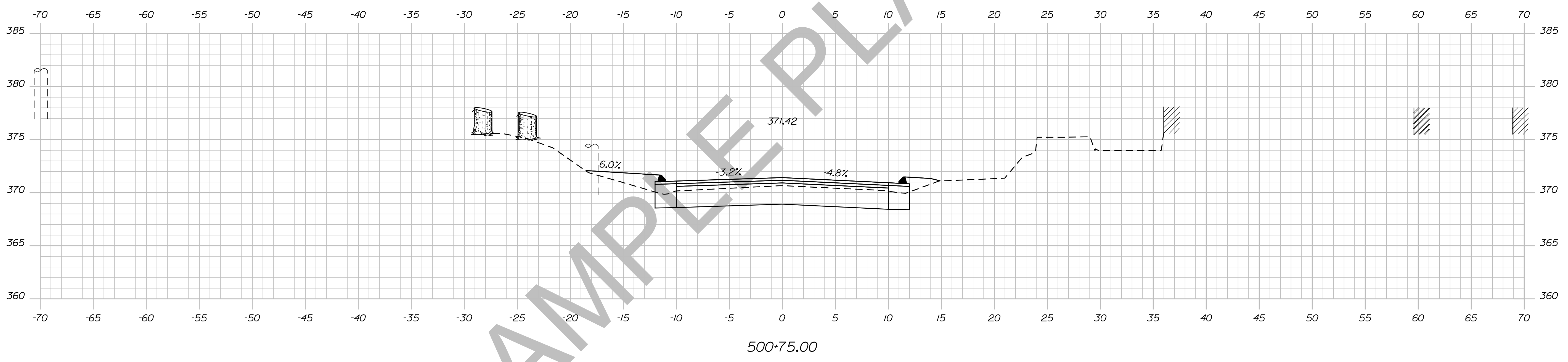

STATE OF MAINE DEPARTMENT OF TRANSPORTATION		018246.00	PIN 18246.00	HIGHWAY PLANS
	SIGNATURE	P.E. NUMBER	DATE	
	BY	DATE		
	PROJ. MANAGER	ERNEST MARTIN		
	DESIGN-DETAILED	TRAVIS WEL		
	CHECKED-REVIEWED			
	DESIGN-DETAILED			
	DESIGN-DETAILED			
	REVISIONS 1			
	REVISIONS 2			
	REVISIONS 3			
	REVISIONS 4			
	FIELD CHANGES			

**DEXTER  
ROUTE 7**

**CROSS SECTIONS**

SHEET NUMBER
<b>159</b>
OF 15



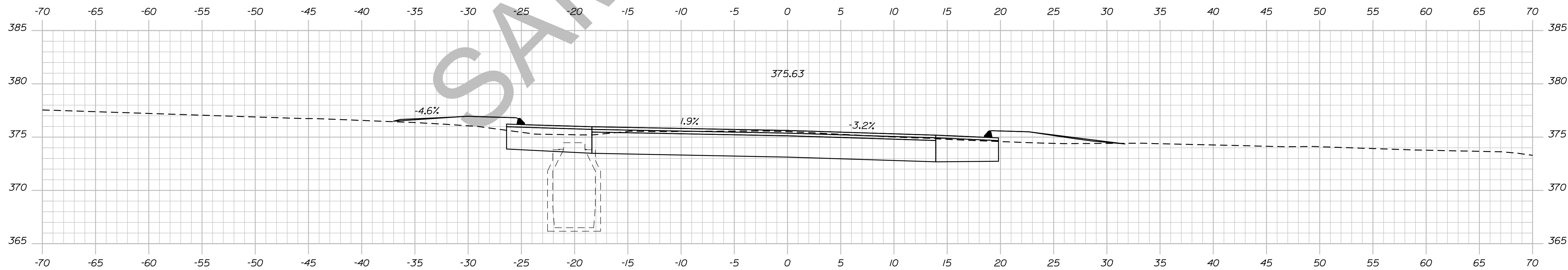
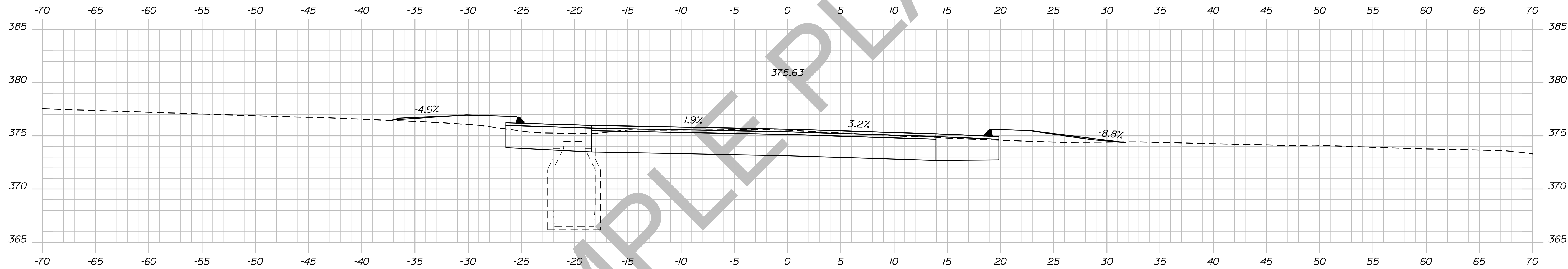

SAMPLE PLAN SET

STATE OF MAINE  
DEPARTMENT OF TRANSPORTATION  
018246.00  
PIN  
18246.00  
HIGHWAY PLANS

PROJ. MANAGER	ERNEST MARTIN	BY	DATE
CHECKED-REVIEWED	TRAVIS WOLFE		
DESIGNED-DETAILED		SIGNATURE	
DESIGNS DET AILED		P.E. NUMBER	
REVISIONS 1		DATE	
REVISIONS 2			
REVISIONS 3			
REVISIONS 4			
FIELD CHANGES			

DEXTER  
ROUTE 7  
CROSS SECTIONS

SHEET NUMBER  
**160**  
OF 15

Date: 5/19/2014

Username: Allee.Mousseau

Division: HIGHWAY

Filename: ... \161\_XSECT\_550+00\_128.dgn

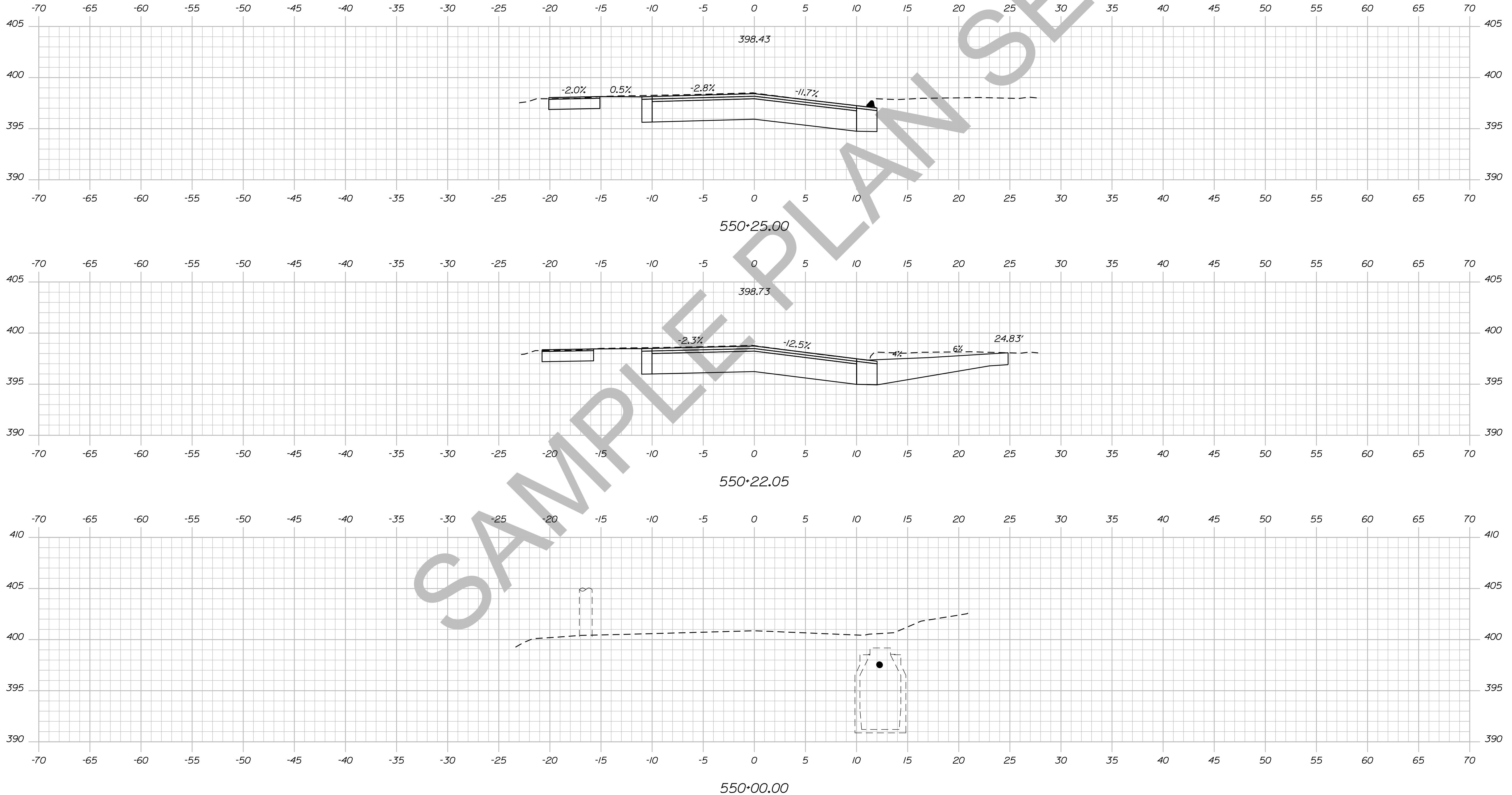

STATE OF MAINE  
DEPARTMENT OF TRANSPORTATION

018246.00

PIN  
18246.00

HIGHWAY PLANS

SIGNATURE

P.E. NUMBER

DATE

DATE

BY

PROJ. MANAGER

DESIGN DETAILED

CHECKED-REVIEWED

DESIGN DETAILED

DESIGN DETAILED

REVISIONS 1

REVISIONS 2

REVISIONS 3

REVISIONS 4

FIELD CHANGES

DEXTER  
ROUTE 7

CROSS SECTIONS

SHEET NUMBER

161

OF 15

Sta. 550+00.00 to Sta. 550+25.00

Date: 5/19/2014

Username: Alee.Mousseau

Division: HIGHWAY

Filename: ... \162\_XSECT\_550+50\_129.dgn

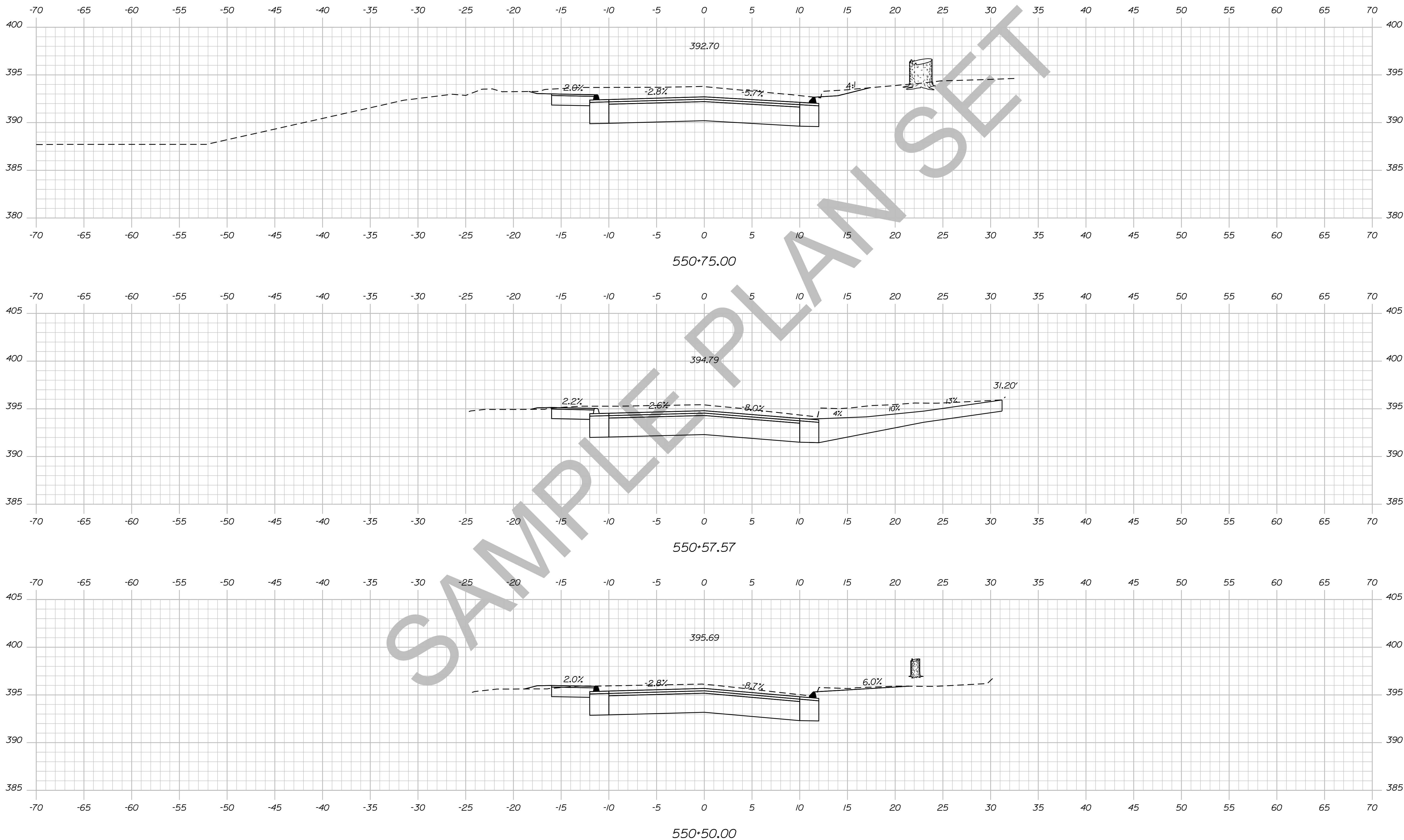

STATE OF MAINE DEPARTMENT OF TRANSPORTATION		018246.00	PIN 18246.00	HIGHWAY PLANS
	SIGNATURE	P.E. NUMBER	DATE	
	BY	DATE		
	PROJ. MANAGER	ERNEST MARTIN		
	DESIGN-DETAILED	TRAVIS WELT		
	CHECKED-REVIEWED			
	DESIGNS DET AILED			
	DESIGNS DET AILED			
	REVISIONS 1			
	REVISIONS 2			
	REVISIONS 3			
	REVISIONS 4			
	FIELD CHANGES			
DEXTER ROUTE 7 CROSS SECTIONS				
SHEET NUMBER <b>162</b> OF 15				

Date: 5/19/2014

Username: Alee.Mousseau

Division: HIGHWAY

Filename: ... \163\_XSECT\_551+00\_130.dgn

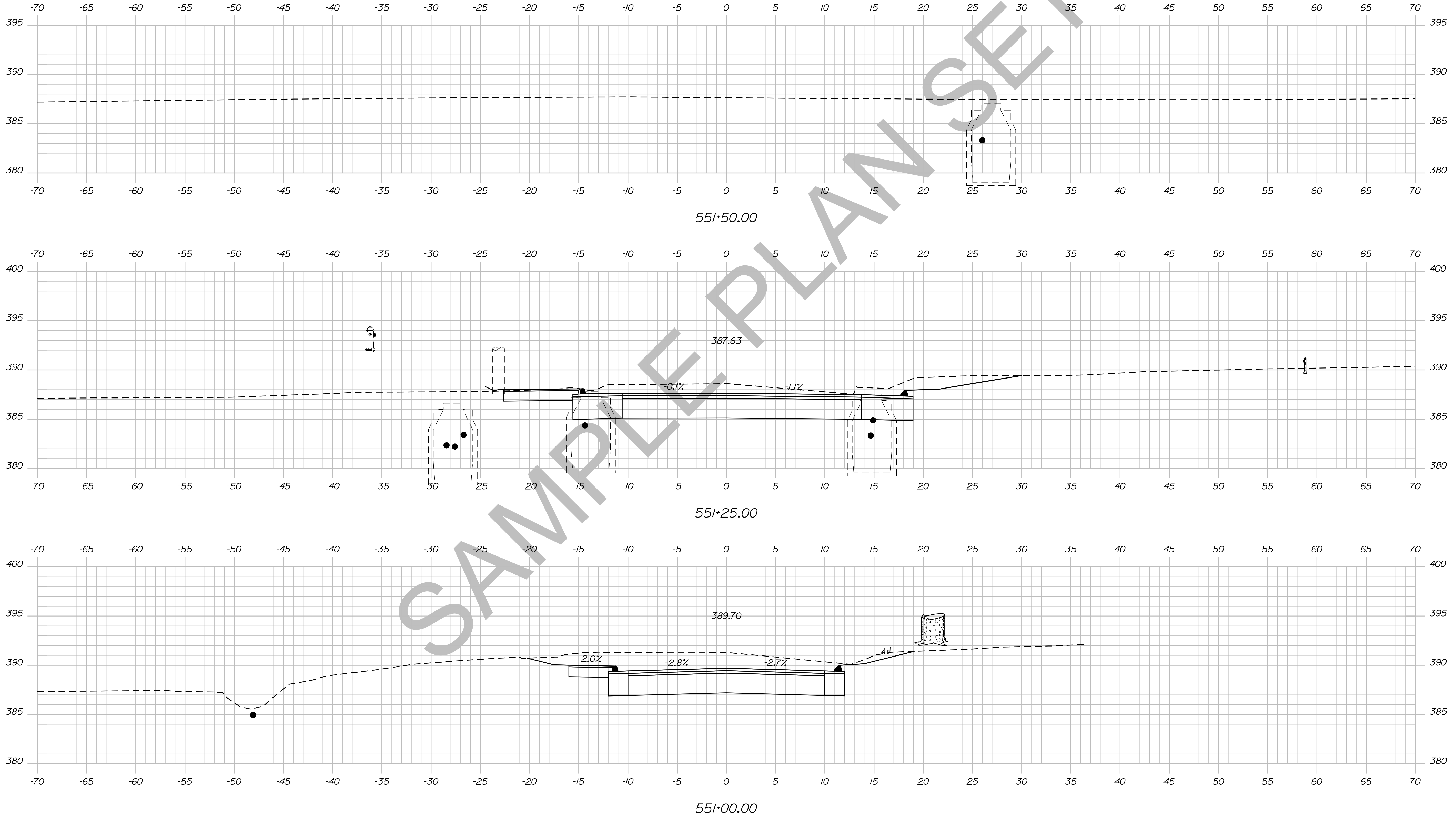

STATE OF MAINE  
DEPARTMENT OF TRANSPORTATION  
018246.00  
PIN  
18246.00  
HIGHWAY PLANS

DATE	BY	PROJ. MANAGER	ERNEST MARTIN
		TRAVIS WHEEL	
		CHECKED-REVIEWED	
		DESIGNS DET AILED	
		DESIGNS DET AILED	
		REVISIONS 1	
		REVISIONS 2	
		REVISIONS 3	
		REVISIONS 4	
		FIELD CHANGES	

DEXTER  
ROUTE 7  
CROSS SECTIONS

SHEET NUMBER  
**163**  
OF 15

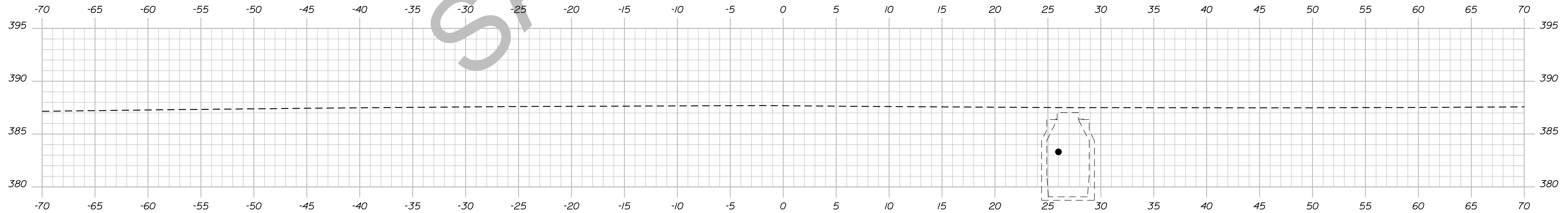

551+50.95

Sta. 551+50.95 to Sta. 551+50.95

SAMPLE PLAN SET

STATE OF MAINE  
DEPARTMENT OF TRANSPORTATION

018246.00

PIN  
18246.00

HIGHWAY PLANS

SIGNATURE
P.E. NUMBER
DATE

PROJ. MANAGER	ERNEST MARTIN	BY	DATE
CHECKED-REVIEWED	TRAVIS WEL		
DESIGNS DETAILED			
DESIGNS DETAILED			
REVISIONS 1			
REVISIONS 2			
REVISIONS 3			
REVISIONS 4			
FIELD CHANGES			

DEXTER  
ROUTE 7  
CROSS SECTIONS

SHEET NUMBER

164

OF 15

Date: 5/19/2014

Username: Allee.Mousseau

Division: HIGHWAY

Filename: ... \165\_XSECT\_600+00\_132.dgn

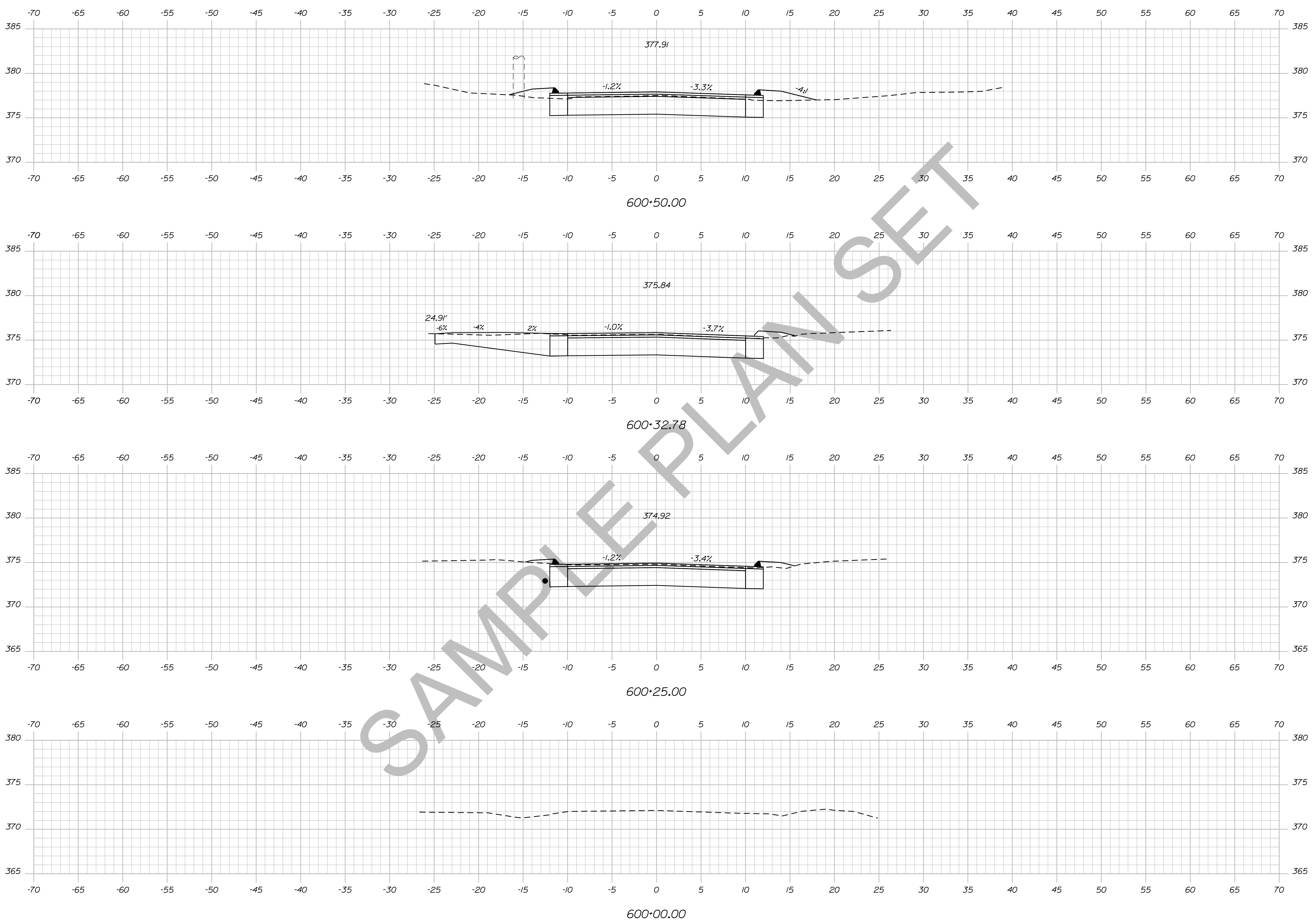

STATE OF MAINE DEPARTMENT OF TRANSPORTATION		018246.00		PIN 18246.00		HIGHWAY PLANS	
SIGNATURE		P.E. NUMBER		DATE		FIELD CHANGES	
PROJ. MANAGER	ERNEST MARTIN	BY	DATE	DESIGN-DETAILED	TRAVIS WOLFE	DESIGN-REVIEWED	
CHECKED		DESIGN-DETAILED		DESIGN-REVIEWED		DESIGN-REVIEWED	
REVISIONS 1		REVISIONS 1		REVISIONS 2		REVISIONS 2	
REVISIONS 2		REVISIONS 3		REVISIONS 3		REVISIONS 3	
REVISIONS 3		REVISIONS 4		REVISIONS 4		REVISIONS 4	
REVISIONS 4		FIELD CHANGES		FIELD CHANGES		FIELD CHANGES	
DEXTER ROUTE 7				CROSS SECTIONS			
SHEET NUMBER				165			
				OF 15			

Date: 5/19/2014

Username: Ailee.Mousseau

Division: HIGHWAY

Filename: ... \166\_XSECT\_600+56\_133.dgn

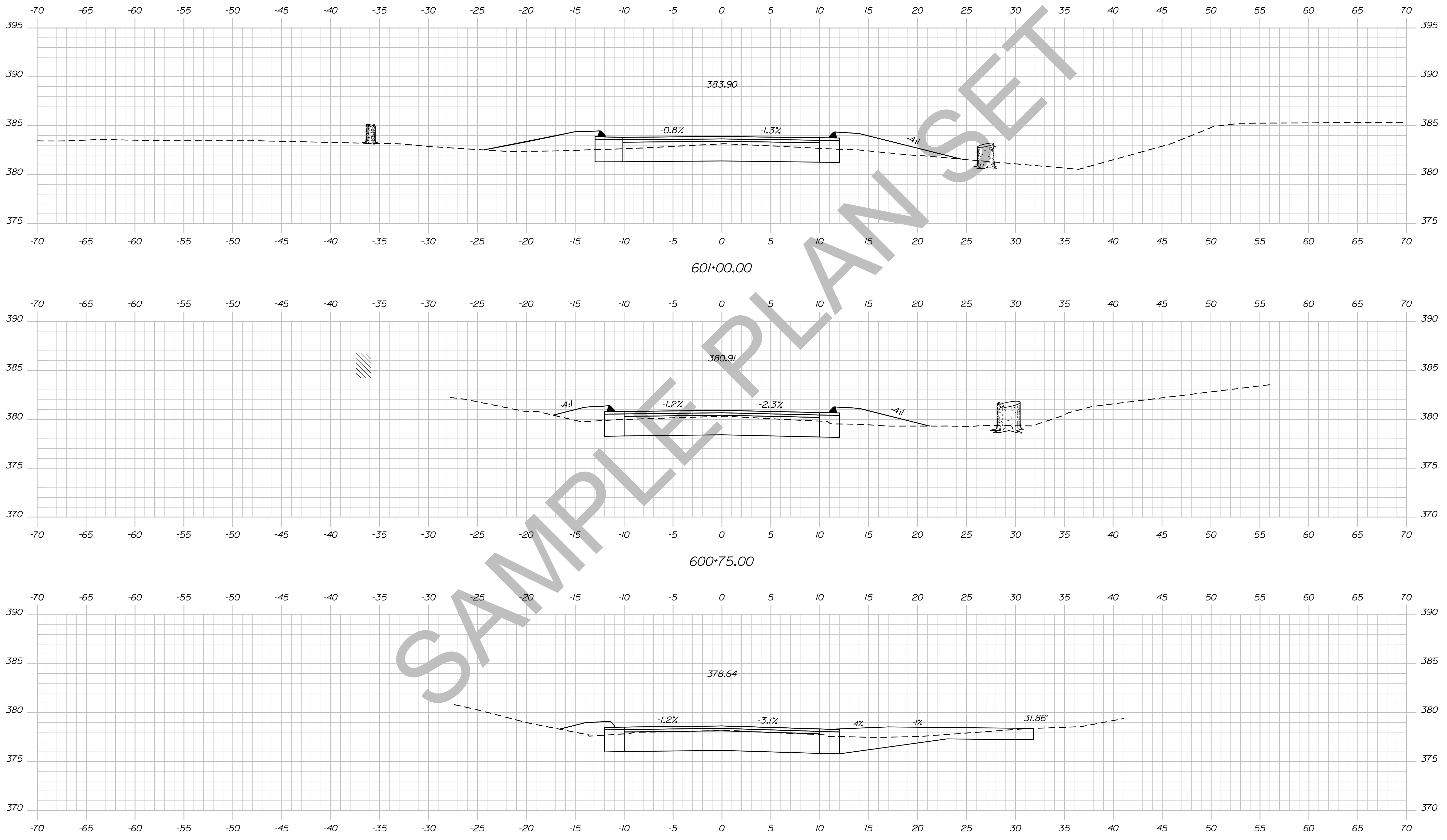

STATE OF MAINE DEPARTMENT OF TRANSPORTATION		018246.00	PIN 18246.00	HIGHWAY PLANS
	SIGNATURE	P.E. NUMBER	DATE	
	ERNEST MARTIN	TRAVIS WHEEL		
	DESIGN-DETAILED	DESIGN-REVIEWED		
	CHECKED	DESIGN-DETAILED		
	DESIGN-DETAILED	REVISIONS 1		
	REVISIONS 1	REVISIONS 2		
	REVISIONS 2	REVISIONS 3		
	REVISIONS 3	REVISIONS 4		
	REVISIONS 4	FIELD CHANGES		
DEXTER ROUTE 7 CROSS SECTIONS				
SHEET NUMBER <b>166</b> OF 15				



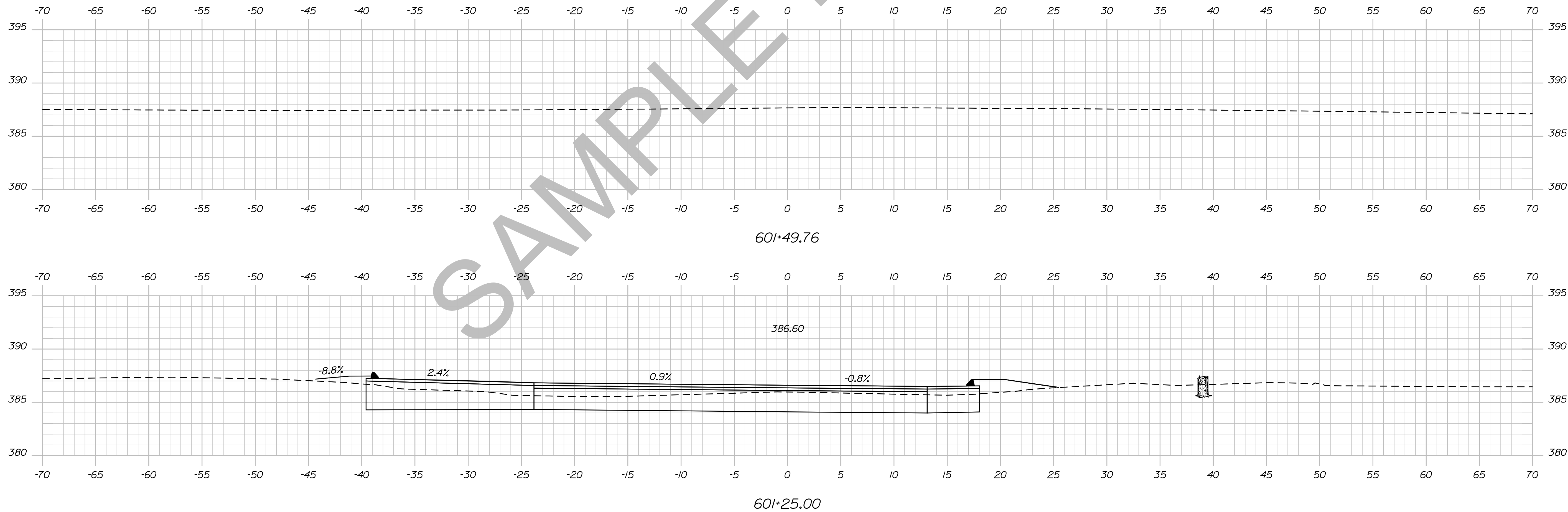

SAMPLE PLAN SET

STATE OF MAINE  
DEPARTMENT OF TRANSPORTATION  
018246-00  
PIN  
18246.00  
HIGHWAY PLANS

PROJ. MANAGER	ERNEST MARTIN	BY	DATE
DESIGN-DETAILED	TRAVIS WOLFE		
CHECKED-REVIEWED			
DESIGN-DETAILED			
REVISIONS 1			
REVISIONS 2			
REVISIONS 3			
REVISIONS 4			
FIELD CHANGES			

DEXTER  
ROUTE 7  
CROSS SECTIONS

SHEET NUMBER  
**167**  
OF 15

Date: 5/19/2014

Username: Allee.Mousseau

Division: HIGHWAY

Filename: ... \168\_XSECT\_650+00\_135.dgn

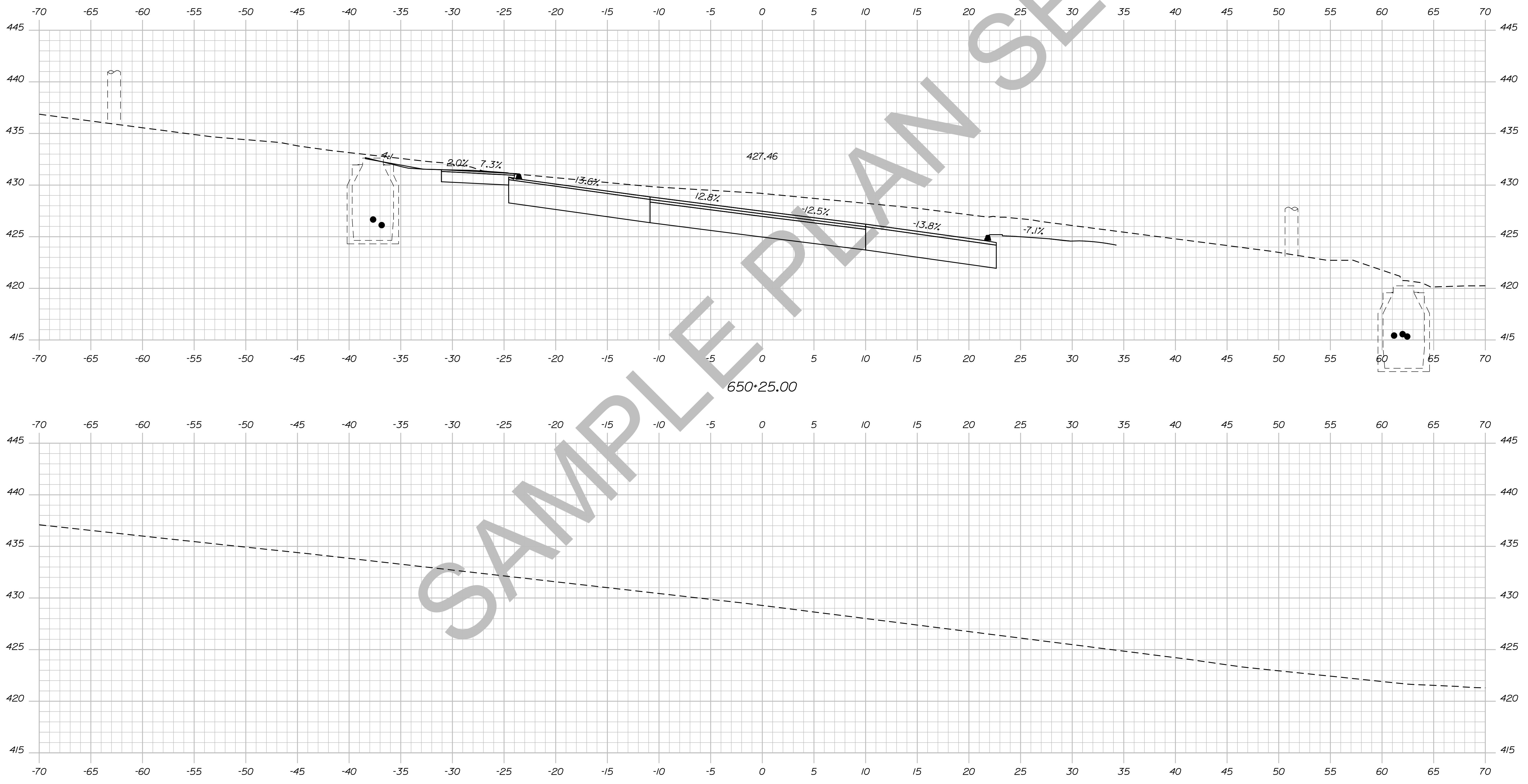

STATE OF MAINE  
DEPARTMENT OF TRANSPORTATION  
018246.00  
PIN  
18246.00  
HIGHWAY PLANS

DESIGN/REVIEW	DATE	BY	SIGNATURE
DESIGN DETAILED		TRAVIS WHEL	
CHECKED-REVIEWED			
DESIGN DETAILED			
DESIGN DETAILED			
REVISIONS 1			
REVISIONS 2			
REVISIONS 3			
REVISIONS 4			
FIELD CHANGES			

PROJ. MANAGER ERNEST MARTIN  
Dexter  
Route 7  
CROSS SECTIONS

SHEET NUMBER  
**168**  
OF 15

Date: 5/19/2014

Username: Allee.Mousseau

Division: HIGHWAY

Filename: ... \169\_XSECT\_650+50\_136.dgn

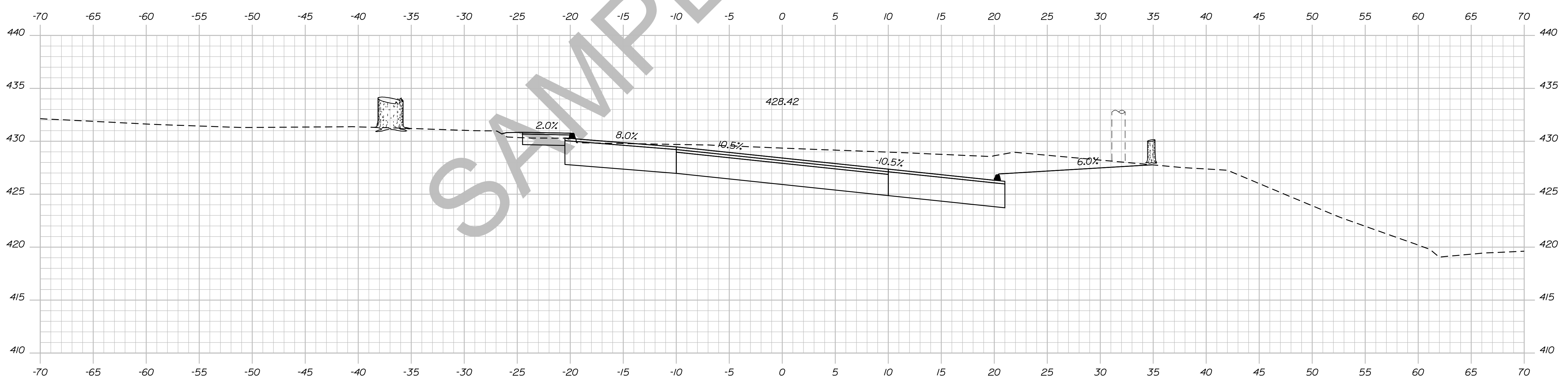
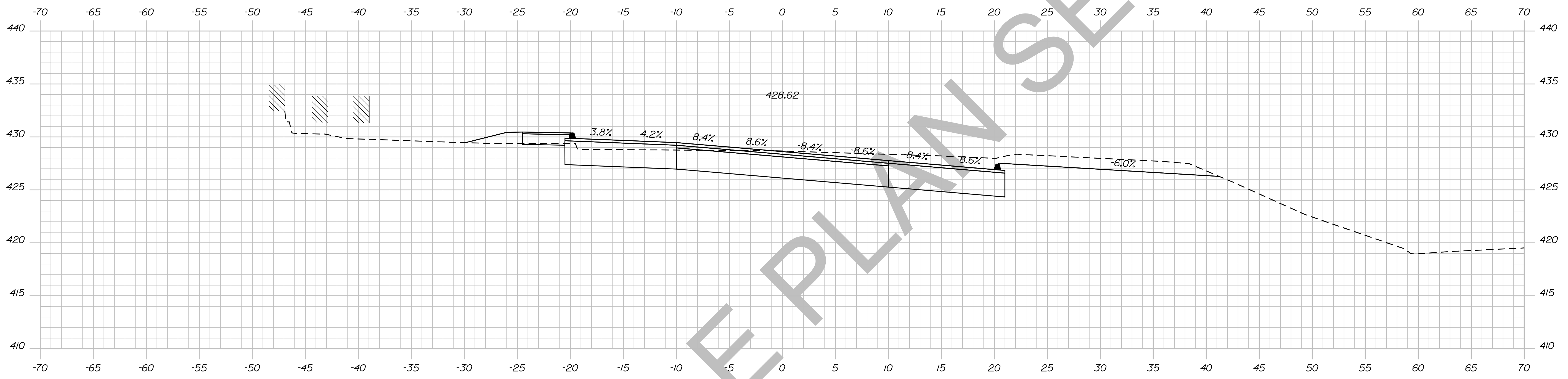

STATE OF MAINE  
DEPARTMENT OF TRANSPORTATION  
018246.00  
PIN  
18246.00  
HIGHWAY PLANS

PROJ. MANAGER	ERNEST MARTIN	BY	DATE
CHECKED-REVIEWED	TRAVIS WOLFE		
DESIGNED-DETAILED		SIGNATURE	
DESIGNS DET AILED		P.E. NUMBER	
REVISIONS 1		DATE	
REVISIONS 2			
REVISIONS 3			
REVISIONS 4			
FIELD CHANGES			

DEXTER  
ROUTE 7  
CROSS SECTIONS

SHEET NUMBER  
**169**  
OF 15

Date: 5/19/2014

Username: Allee.Mousseau

Division: HIGHWAY

Filename: ... \170\_XSECT\_651+00\_137.dgn

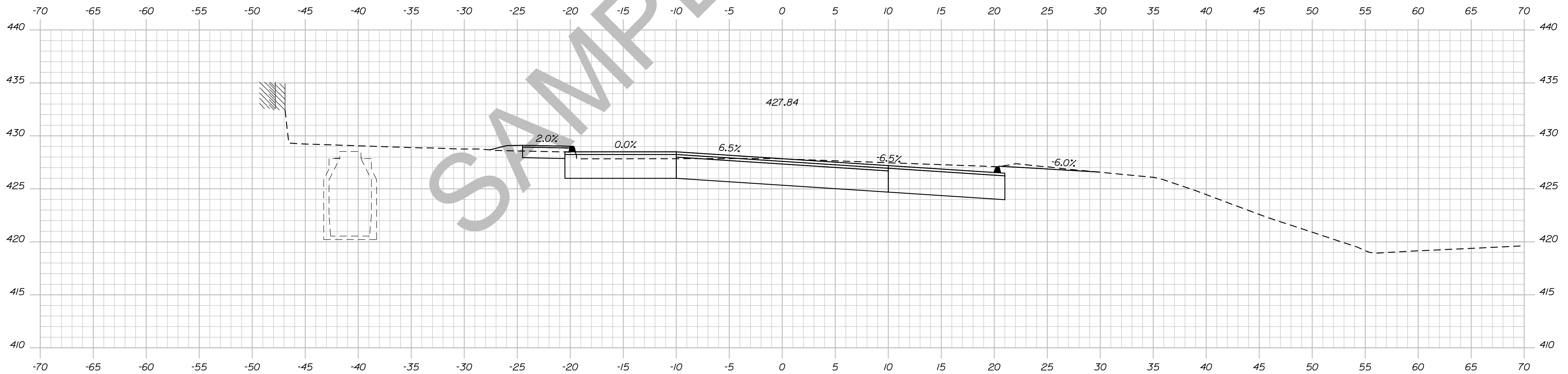
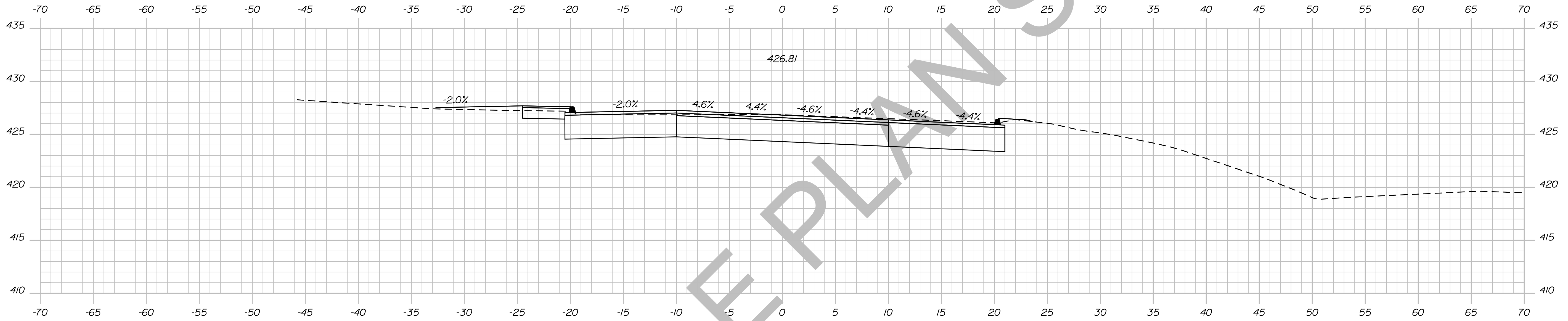

STATE OF MAINE  
DEPARTMENT OF TRANSPORTATION

018246.00

PIN

18246.00

HIGHWAY PLANS

SIGNATURE

DATE

PROJ. MANAGER	ERNEST MARTIN	BY	DATE
CHECKED-REVIEWED	TRAVIS WEL		
DESIGN DETAILED			
DESIGNS DETAILED			
REVISIONS 1			
REVISIONS 2			
REVISIONS 3			
REVISIONS 4			
FIELD CHANGES			

P.E. NUMBER

DATE

DEXTER  
ROUTE 7

CROSS SECTIONS

SHEET NUMBER

170

OF 15

Sta. 651+00.00 to Sta. 651+25.00

Date: 5/19/2014

Username: Allee.Mousseau

Division: HIGHWAY

Filename: ... \171\_XSECT\_651+38\_138.dgn

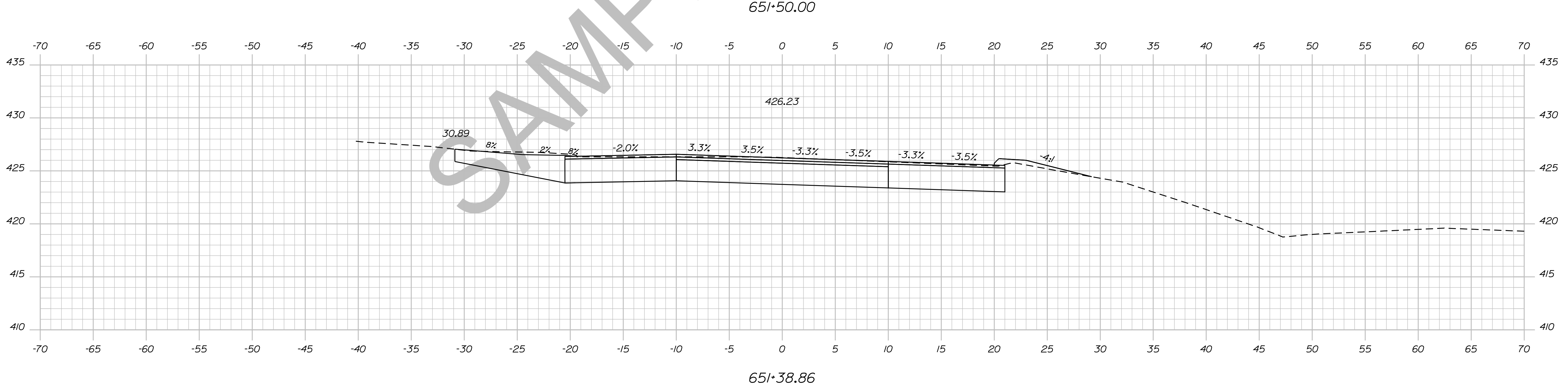
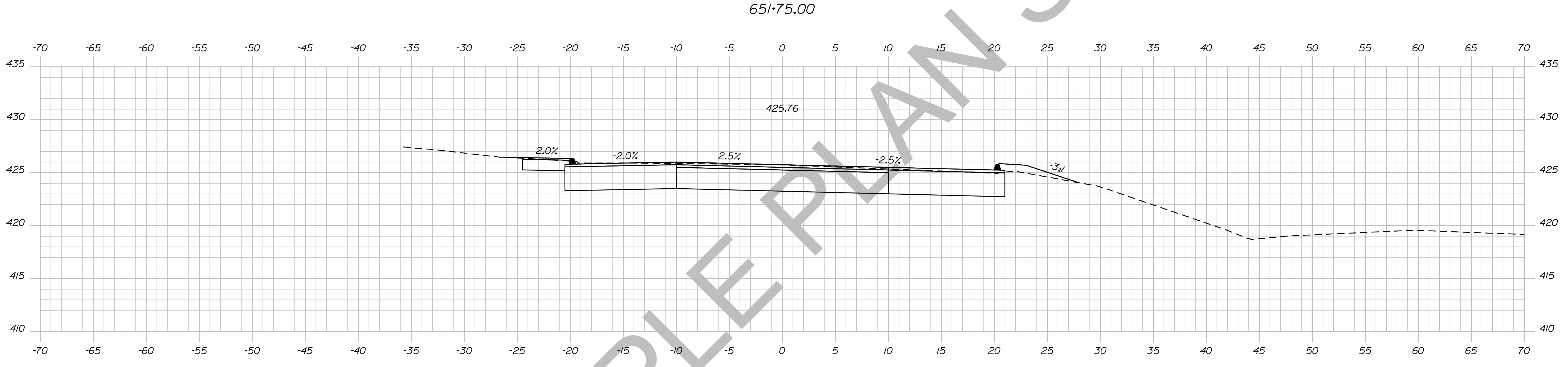
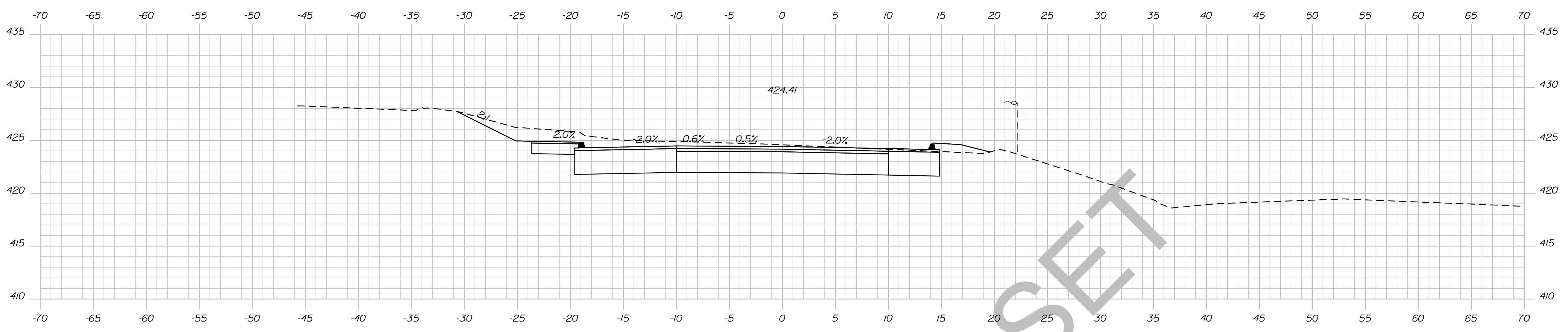

STATE OF MAINE  
DEPARTMENT OF TRANSPORTATION  
018246.00  
PIN  
18246.00  
HIGHWAY PLANS

DESIGN/REVIEWED	DATE	BY
DESIGN: DETAILED		ERNEST MARTIN
CHECKED: REVIEWED		TRAVIS WOLFE
DESIGN: DET AILED		
DESIGN: DET AILED		
REVISIONS 1		
REVISIONS 2		
REVISIONS 3		
REVISIONS 4		
FIELD CHANGES		

DEXTER  
ROUTE 7  
CROSS SECTIONS

SHEET NUMBER  
**171**  
OF 15

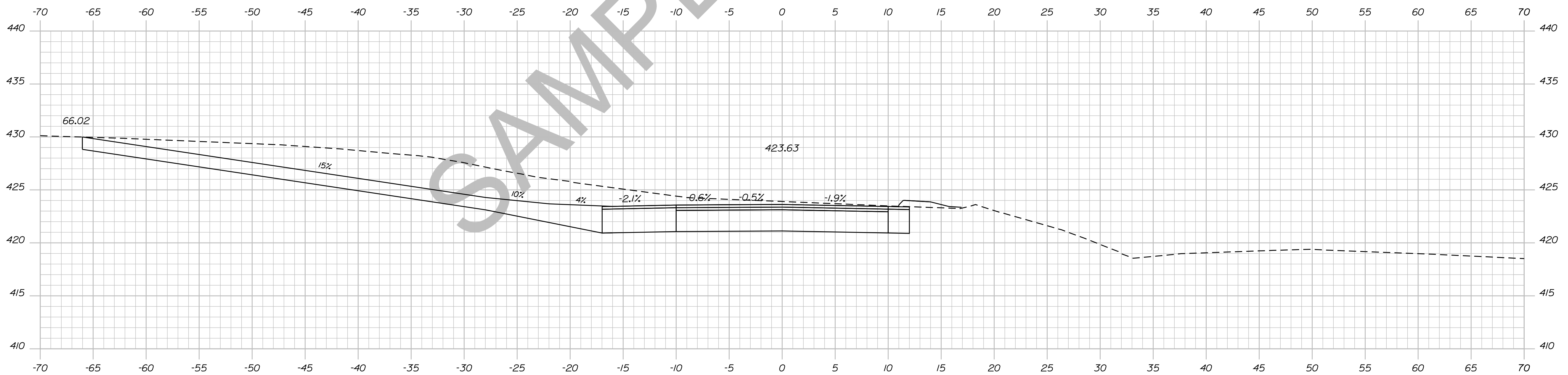
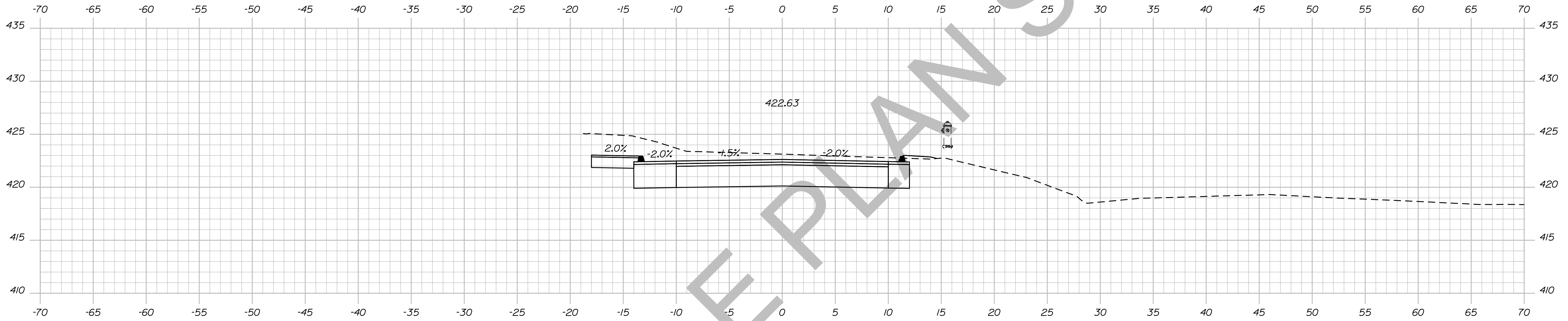

651+86.79

STATE OF MAINE  
DEPARTMENT OF TRANSPORTATION  
018246.00  
PIN  
18246.00  
HIGHWAY PLANS

PROJ. MANAGER	ERNEST MARTIN	BY	DATE
DESIGN-DETAILED	TRAVIS WOLFE		
CHECKED-REVIEWED			
DESIGN-DETAILED			
REVISIONS 1			
REVISIONS 2			
REVISIONS 3			
REVISIONS 4			
FIELD CHANGES			

DEXTER  
ROUTE 7  
CROSS SECTIONS

SHEET NUMBER  
**172**  
OF 15

Date: 5/19/2014

Username: Alee.Mousseau

Division: HIGHWAY

Filename: ... \173\_XSECT\_652+25\_140.dgn

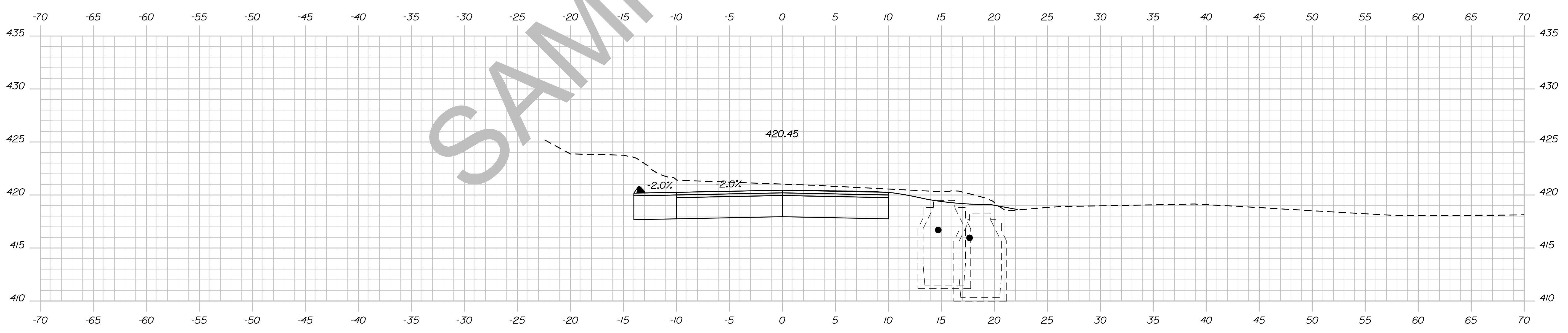
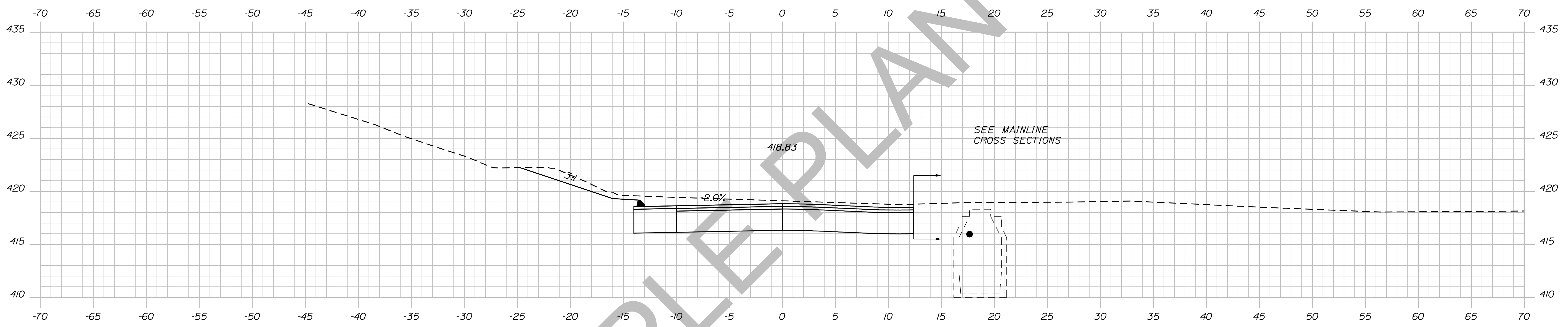
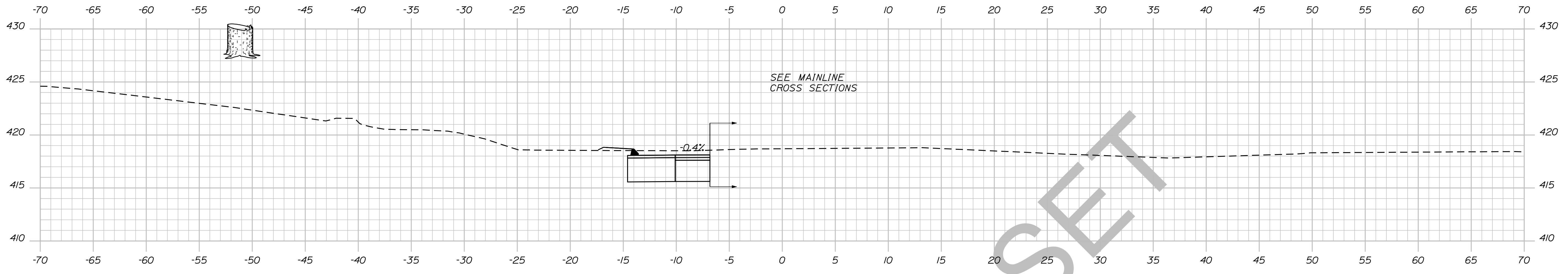

STATE OF MAINE  
DEPARTMENT OF TRANSPORTATION  
018246.00  
PIN  
18246.00  
HIGHWAY PLANS

PROJ. MANAGER	BY	DATE	SIGNATURE
ERNEST MARTIN	TRAVIS WEL		
DESIGN-DETAILED	CHECKED-REVIEWED	DESIGN-DETAILED	P.E. NUMBER
REVISIONS 1	REVISIONS 2	REVISIONS 3	DATE

DEXTER  
ROUTE 7  
CROSS SECTIONS

SHEET NUMBER  
173  
OF 15



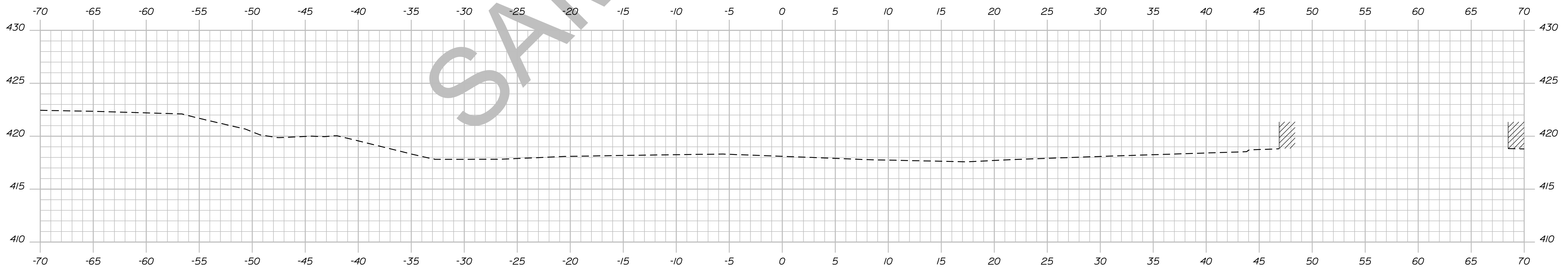

653+00.00

Sta. 653+00.00 to Sta. 653+00.00

**DEXTER  
ROUTE 7  
CROSS SECTIONS**

SHEET NUMBER

**174**

OF 15

PROJ. MANAGER	ERNEST MARTIN	BY	DATE
DESIGN-DETAILED	TRAVIS WOLFE		
CHECKED-REVIEWED			
DESIGN-DETAILED			
DESIGN-DETAILED			
REVISIONS 1			
REVISIONS 2			
REVISIONS 3			
REVISIONS 4			
FIELD CHANGES			

SIGNATURE	
P.E. NUMBER	
DATE	

STATE OF MAINE  
DEPARTMENT OF TRANSPORTATION  
**018246.00**  
PIN  
18246.00  
HIGHWAY PLANS

Date: 5/19/2014

Username: Allee.Mousseau

Division: HIGHWAY

Filename: ... \175\_XSECT\_700+00\_142.dgn

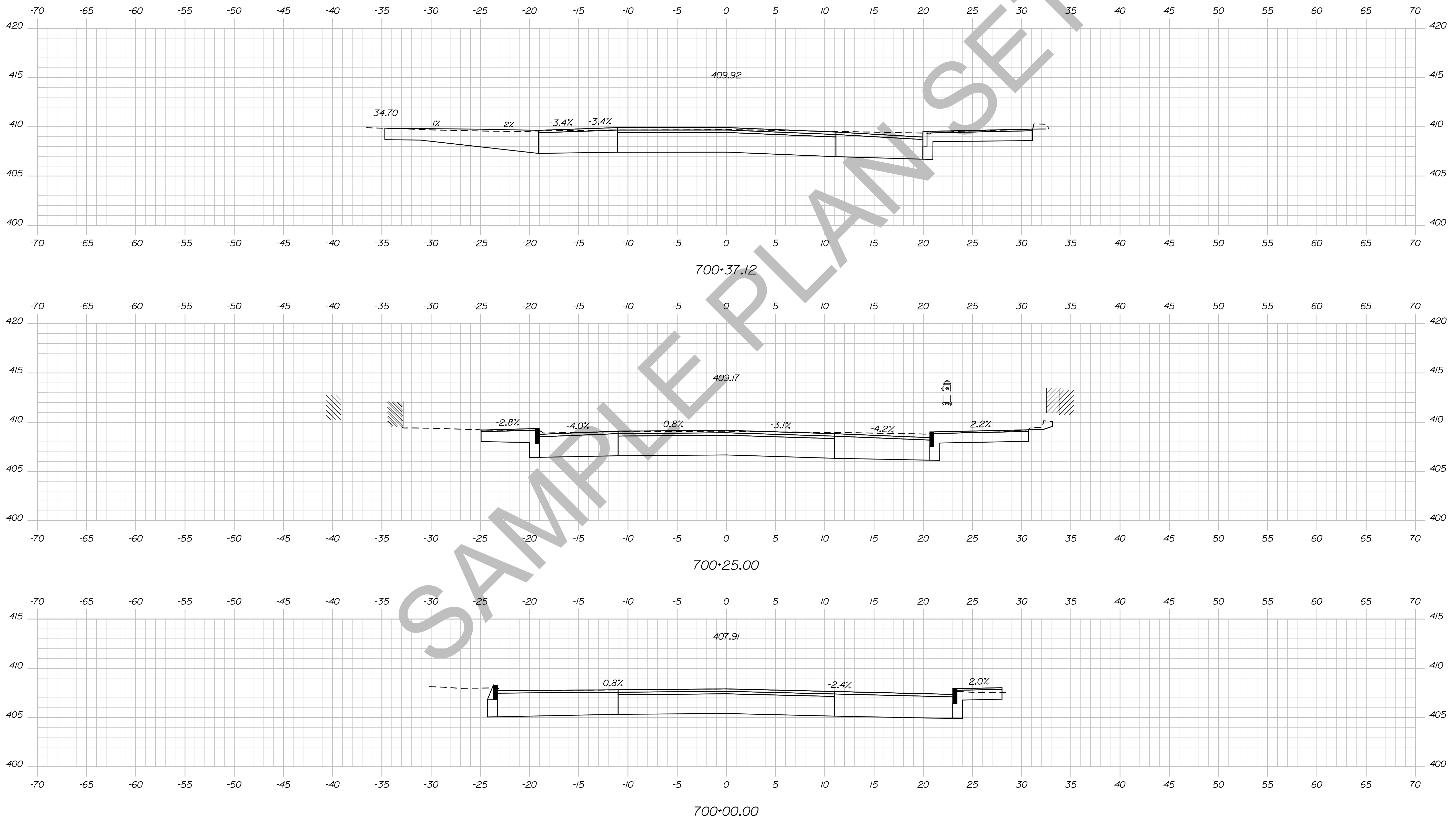

STATE OF MAINE  
DEPARTMENT OF TRANSPORTATION  
018246.00  
PIN  
18246.00  
HIGHWAY PLANS

PROJ. MANAGER	BY	DATE	SIGNATURE	P.E. NUMBER	DATE
ERNEST MARTIN	TRAVIS WEL				
DESIGN-DETAILED					
CHECKED-REVIEWED					
DESIGN-DETAILED					
DESIGN-DETAILED					
REVISIONS 1					
REVISIONS 2					
REVISIONS 3					
REVISIONS 4					
FIELD CHANGES					

DEXTER  
ROUTE 7  
CROSS SECTIONS

SHEET NUMBER  
**175**  
OF 15

Date: 5/19/2014

Username: Allee.Mousseau

Division: HIGHWAY

Filename: ... \176\_XSECT\_700+50\_143.dgn

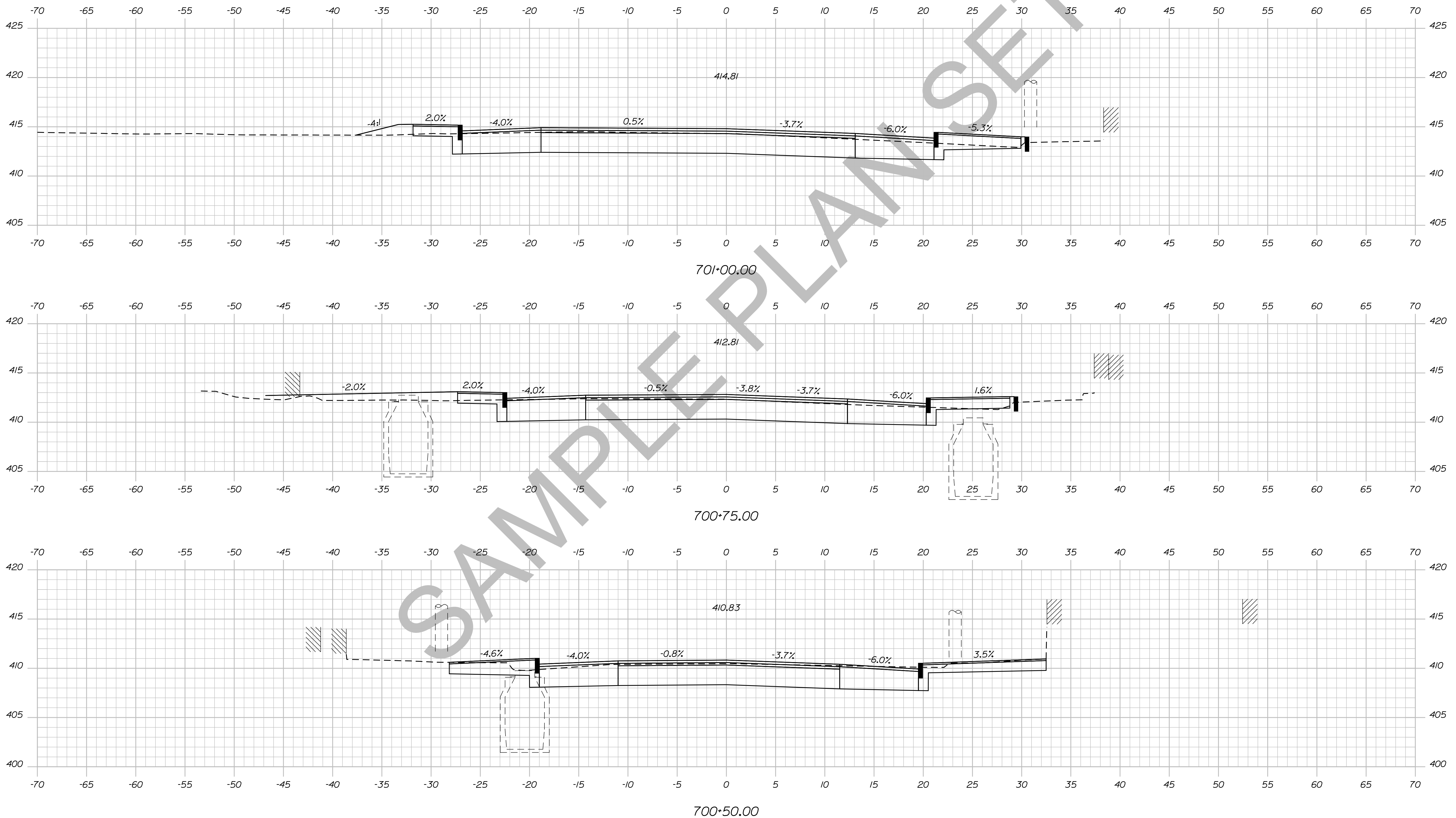

STATE OF MAINE  
DEPARTMENT OF TRANSPORTATION  
018246.00  
PIN  
18246.00  
HIGHWAY PLANS

PROJ. MANAGER	BY	DATE	SIGNATURE	P.E. NUMBER	DATE
ERNEST MARTIN	TRAVIS WEL				
DESIGN DETAILED					
CHECKED-REVIEWED					
DESIGN DETAILED					
DESIGN DETAILED					
REVISIONS 1					
REVISIONS 2					
REVISIONS 3					
REVISIONS 4					
FIELD CHANGES					

DEXTER  
ROUTE 7  
CROSS SECTIONS

SHEET NUMBER  
**176**  
OF 15

Date: 5/19/2014

Username: Alee.Mousseau

Division: HIGHWAY

Filename: ... \177\_XSECT\_701+25\_144.dgn

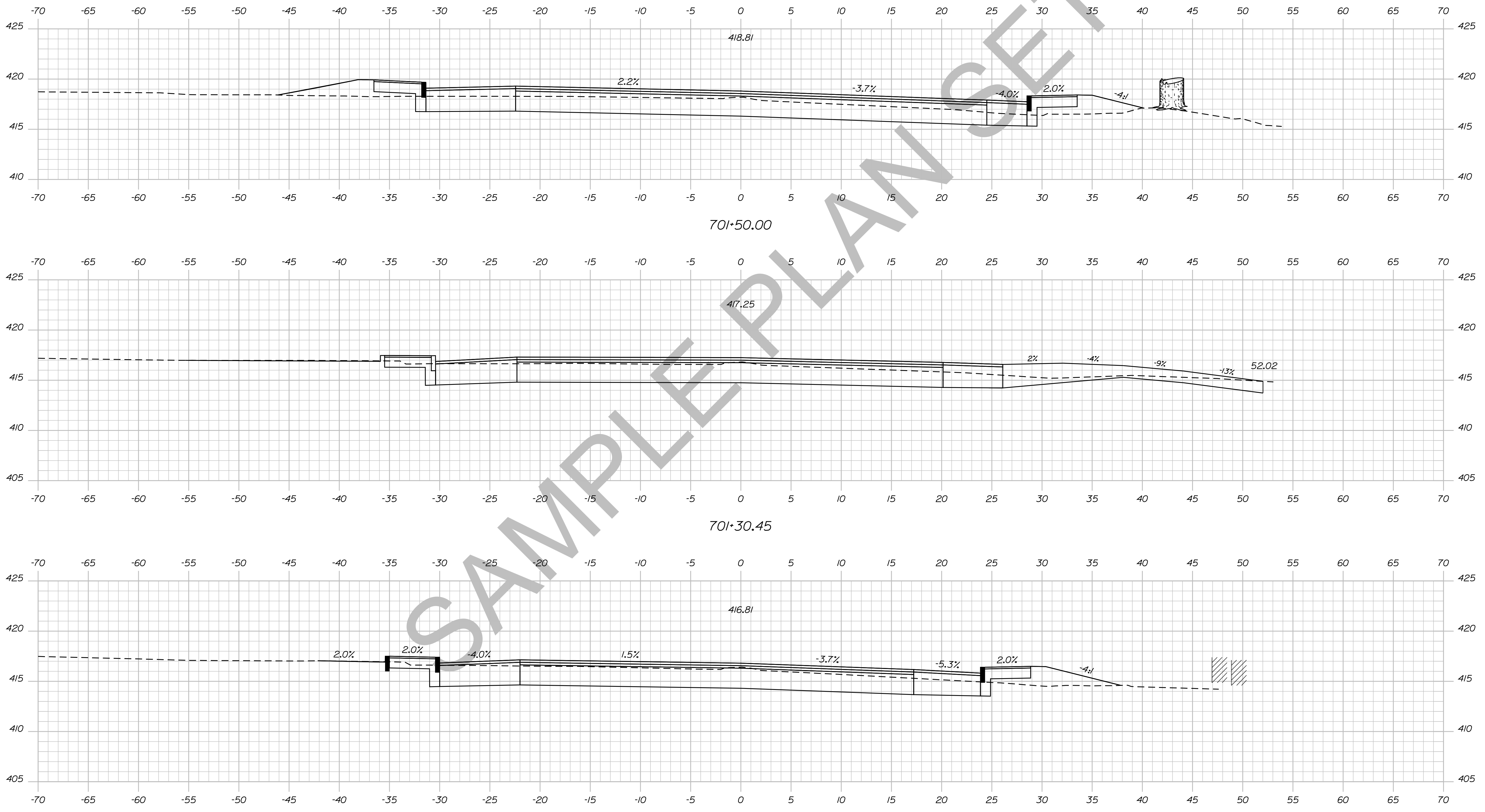

STATE OF MAINE  
DEPARTMENT OF TRANSPORTATION  
018246.00  
PIN 18246.00  
HIGHWAY PLANS

DATE	BY	SIGNATURE	P.E. NUMBER	DATE
	ERNEST MARTIN			
	TRAVIS WHEEL			
	CHECKED-REVIEWED			
	DESIGNED-DRAWN			
	DESIGNED-DRAWN			
	REVISIONS 1			
	REVISIONS 2			
	REVISIONS 3			
	REVISIONS 4			
	FIELD CHANGES			

DEXTER  
ROUTE 7  
CROSS SECTIONS

SHEET NUMBER  
**177**  
OF 15

Date: 5/19/2014

Username: Alee.Mousseau

Division: HIGHWAY

Filename: ... \178\_XSECT\_701+61\_145.dgn

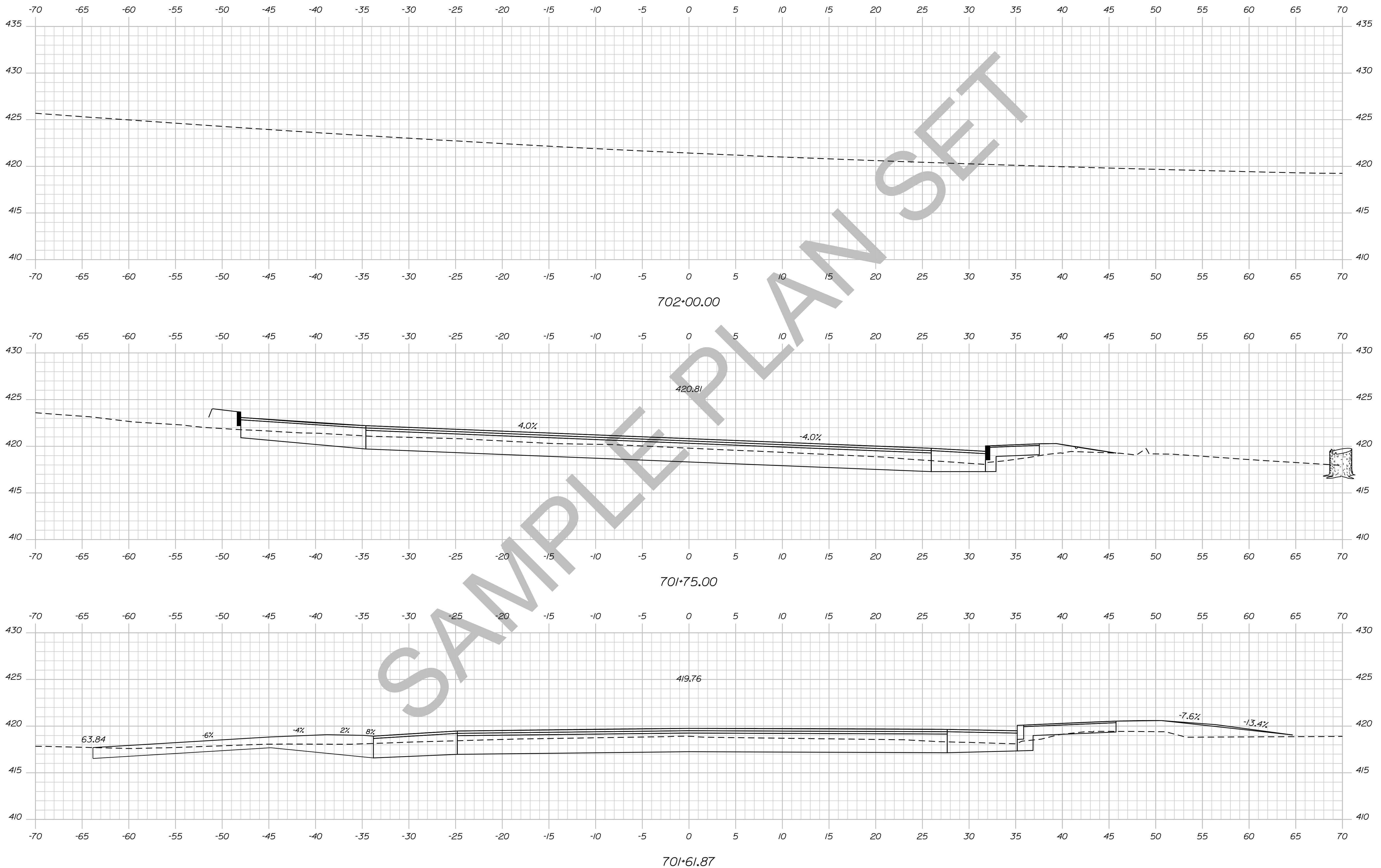

STATE OF MAINE  
DEPARTMENT OF TRANSPORTATION  
018246.00  
PIN 18246.00  
HIGHWAY PLANS

PROJ. MANAGER	ERNEST MARTIN	BY	DATE
DESIGN-DETAILED	TRAVIS WEL		
CHECKED-REVIEWED			
DESIGN-DETAILED			
REVISIONS 1			
REVISIONS 2			
REVISIONS 3			
REVISIONS 4			
FIELD CHANGES			

DEXTER  
ROUTE 7  
CROSS SECTIONS

SHEET NUMBER  
**178**  
OF 15

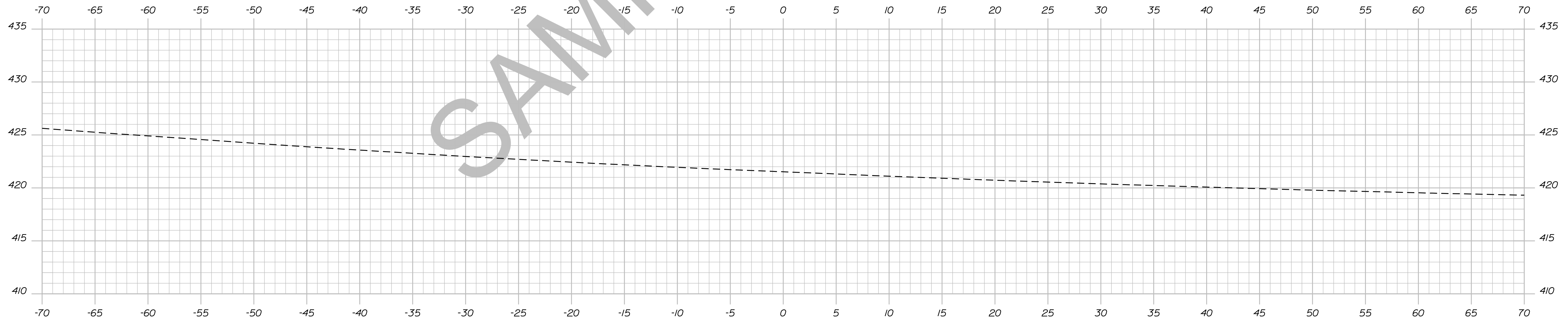

702+01.91

Sta. 702+01.91 to Sta. 702+01.91

STATE OF MAINE  
DEPARTMENT OF TRANSPORTATION

018246.00

PIN  
18246.00

HIGHWAY PLANS

SIGNATURE

P.E. NUMBER

DATE

PROJ. MANAGER ERNEST MARTIN  
DESIGN-DETAILED TRAVIS WEL

CHECKED-REVIEWED  
DESIGN-DETAILED

REVISIONS 1  
REVISIONS 2  
REVISIONS 3  
REVISIONS 4  
FIELD CHANGES

DEXTER  
ROUTE 7

CROSS SECTIONS

SHEET NUMBER

179

OF 15

Date: 5/19/2014

Username: Alee.Mousseau

Division: HIGHWAY

Filename: ... \180\_XSECT\_750+00\_147.dgn

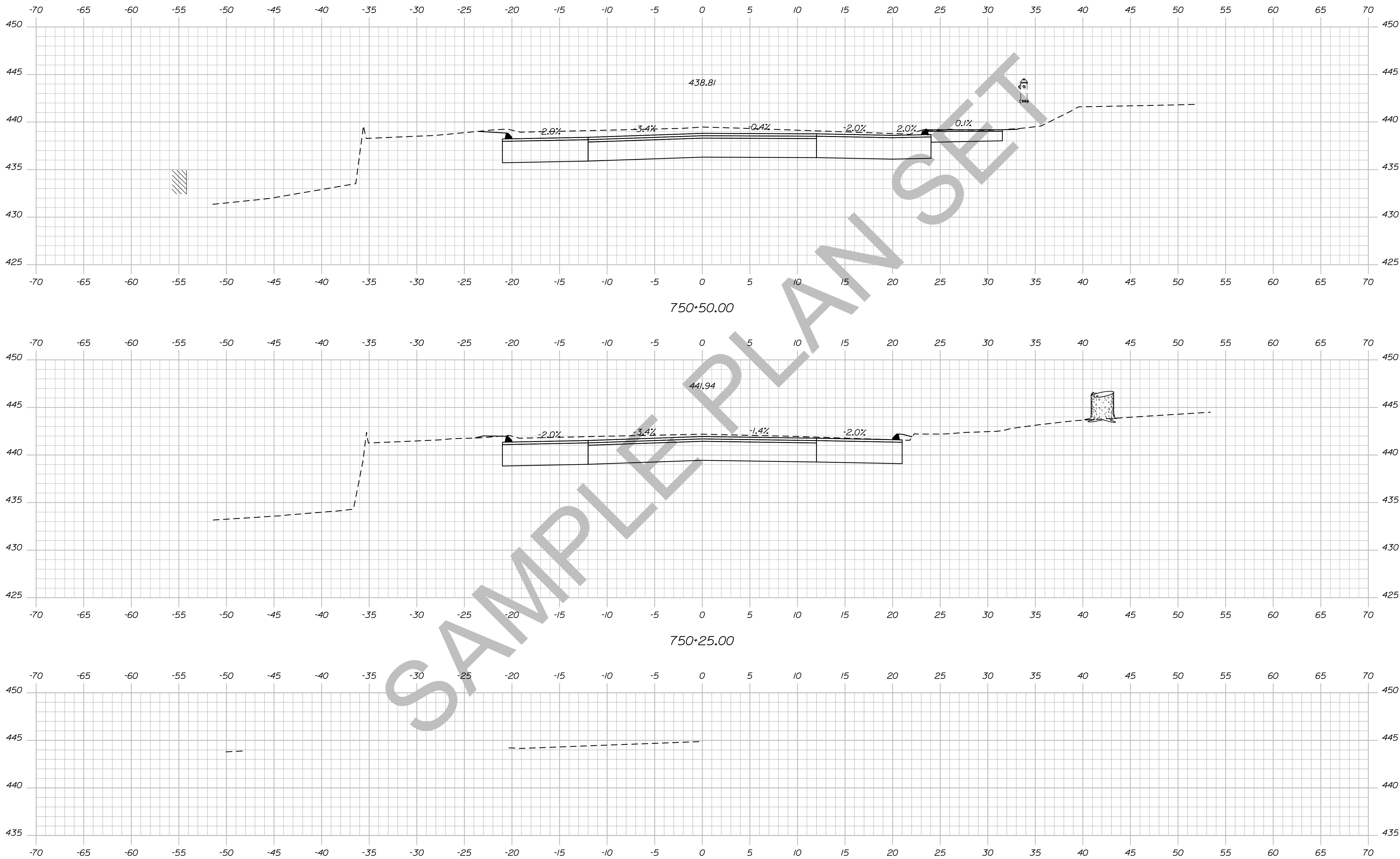

STATE OF MAINE DEPARTMENT OF TRANSPORTATION		018246.00	
		PIN 18246.00	
		HIGHWAY PLANS	
PROJ. MANAGER	ERNEST MARTIN	BY	DATE
DESIGN-DETAILED	TRAVIS WOLFE		
CHECKED-REVIEWED			
DESIGN-DETAILED			
DESIGN-DETAILED			
REVISIONS 1			
REVISIONS 2			
REVISIONS 3			
REVISIONS 4			
FIELD CHANGES			
DEXTER ROUTE 7		CROSS SECTIONS	
SHEET NUMBER		180	
		OF 15	



Date: 5/19/2014

Username: Allee.Mousseau

Division: HIGHWAY

Filename: ... \181\_XSECT\_750+75\_148.dgn

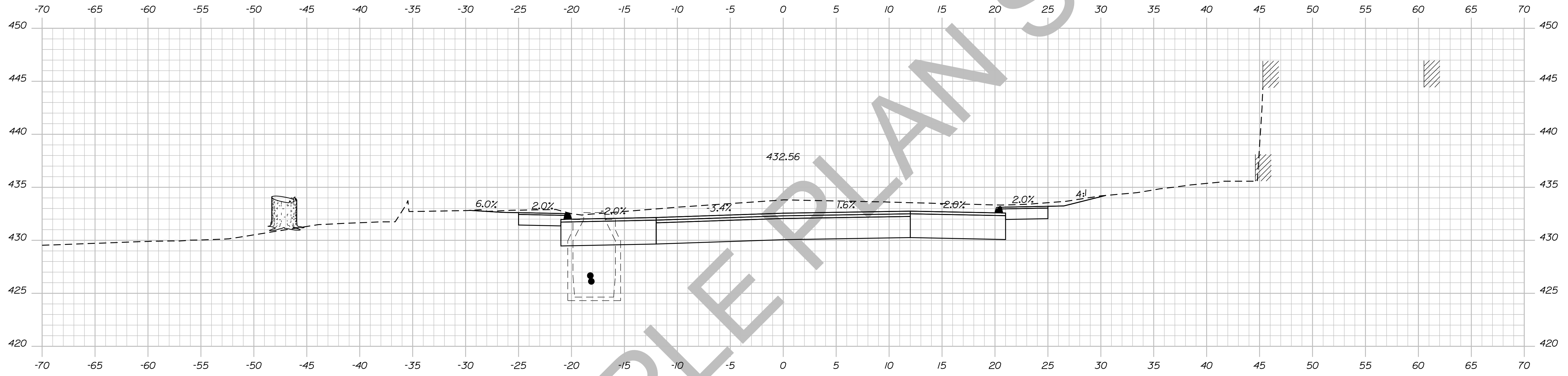

751+00.00

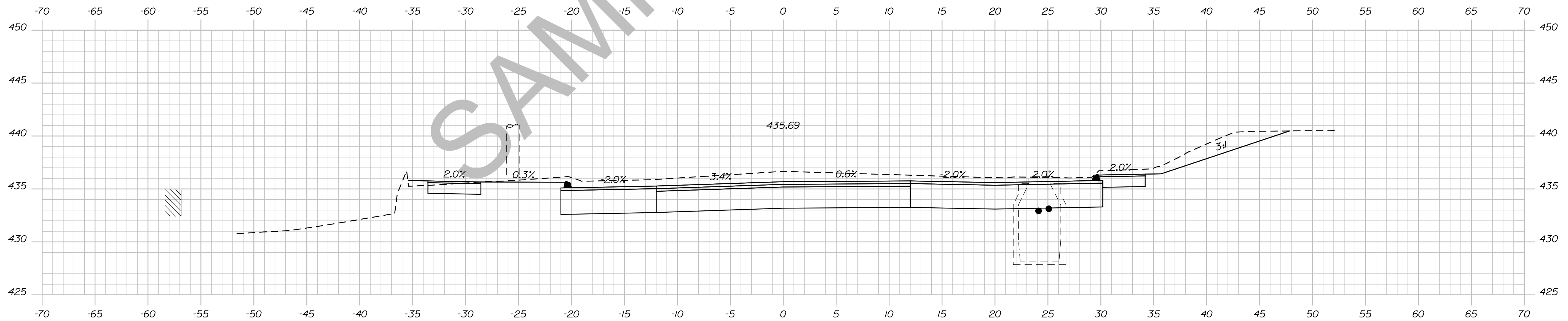

750+75.00

STATE OF MAINE  
DEPARTMENT OF TRANSPORTATION  
018246.00  
PIN  
18246.00  
HIGHWAY PLANS

PROJ. MANAGER	ERNEST MARTIN	BY	DATE
DESIGNED/DETAILED	TRAVIS WELT		
CHECKED/REVIEWED			
DESIGNS DET AILED			
DESIGNS DET AILED			
REVISIONS 1			
REVISIONS 2			
REVISIONS 3			
REVISIONS 4			
FIELD CHANGES			

DEXTER  
ROUTE 7  
CROSS SECTIONS

SHEET NUMBER  
**181**  
OF 15

Date: 5/19/2014

Username: Alee.Mousseau

Division: HIGHWAY

Filename: ... \182\_XSECT\_751+25\_149.dgn

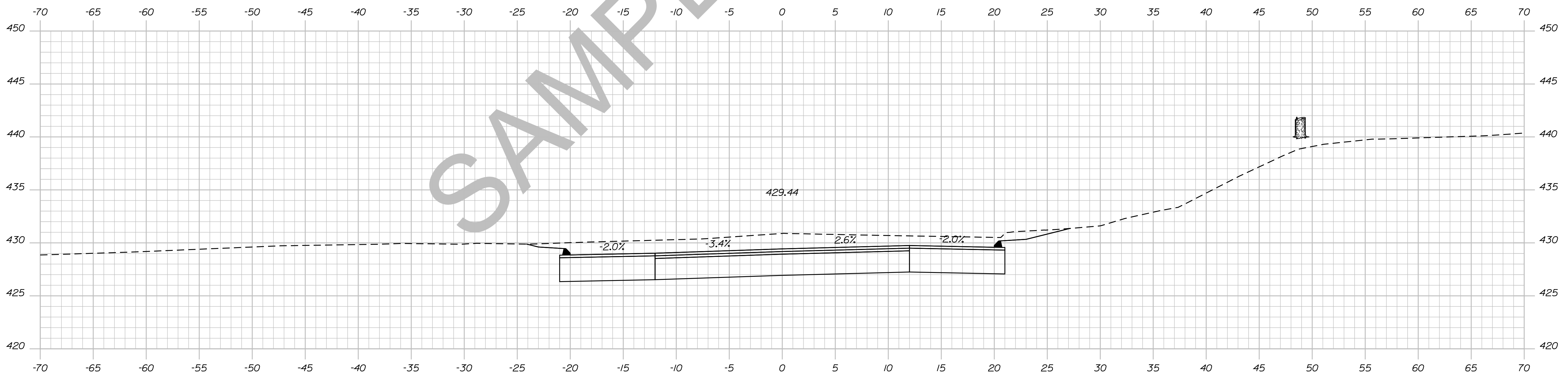
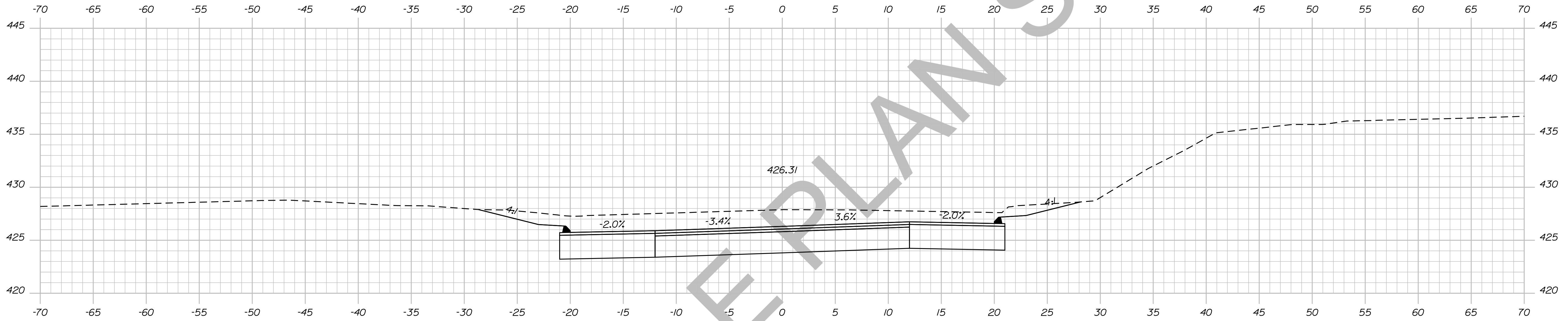

SAMPLE PLAN SET

STATE OF MAINE  
DEPARTMENT OF TRANSPORTATION

018246.00

PIN

18246.00

HIGHWAY PLANS

SIGNATURE

DATE

P.E. NUMBER

DATE

DATE

DATE

DEXTER  
ROUTE 7  
CROSS SECTIONS

SHEET NUMBER

182

OF 15

Sta. 751+25.00 to Sta. 751+50.00

Date: 5/19/2014

Username: Allee.Mousseau

Division: HIGHWAY

Filename: ... \183\_XSECT\_751+75\_150.dgn

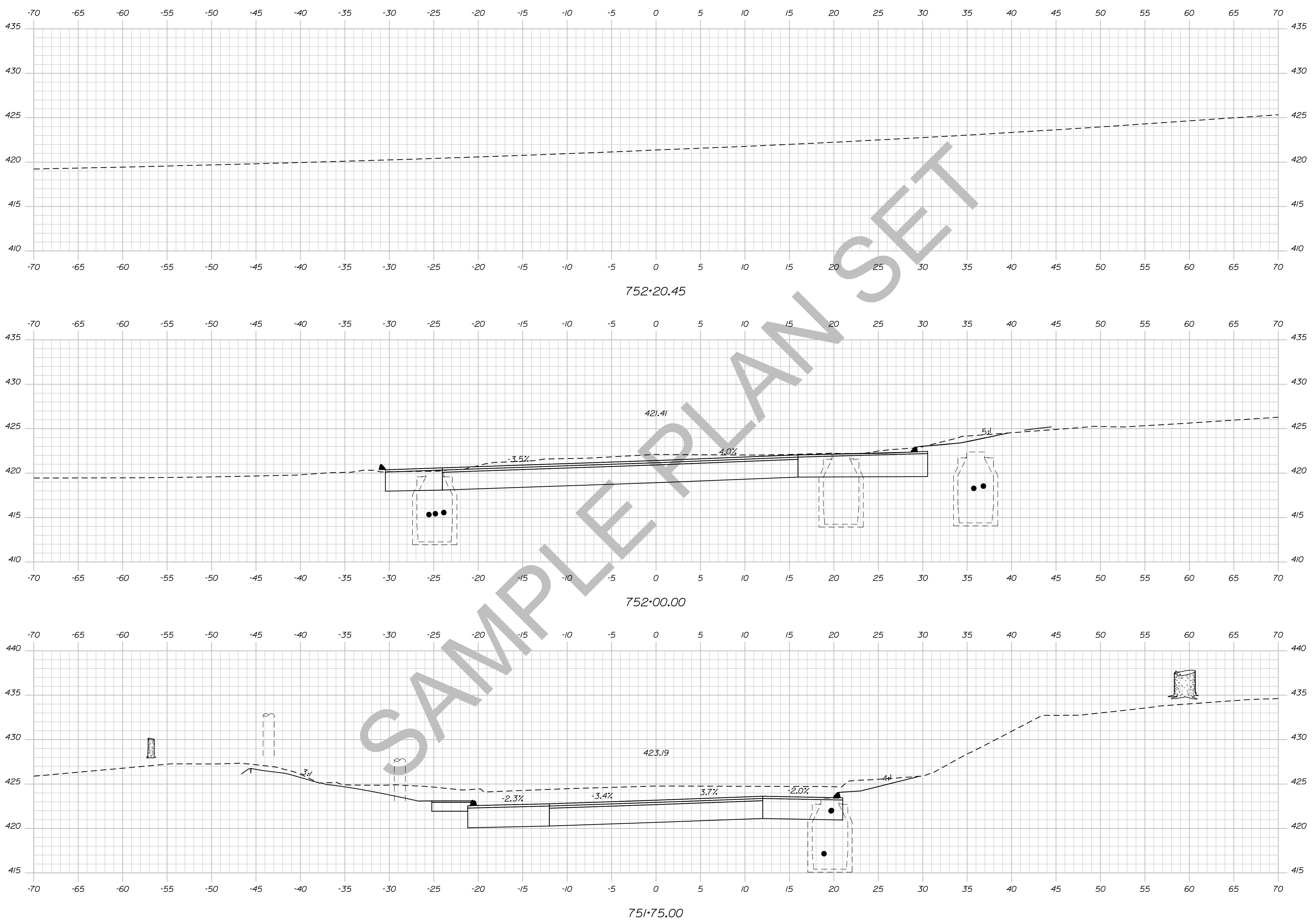

STATE OF MAINE DEPARTMENT OF TRANSPORTATION		018246.00	PIN 18246.00	HIGHWAY PLANS
Dexter Route 7		CROSS SECTIONS		
SHEET NUMBER		183		
OF 15		OF 15		
PROJ. MANAGER	ERNEST MARTIN	BY	DATE	SIGNATURE
DESIGN/DETAILED	TRAVIS WOLFE	CHECKED/REVIEWED		P.E. NUMBER
DESIGNS DET/ALD		DESIGNS DET/ALD		DATE
REVISIONS 1		REVISIONS 1		
REVISIONS 2		REVISIONS 2		
REVISIONS 3		REVISIONS 3		
REVISIONS 4		REVISIONS 4		
FIELD CHANGES				

Date: 5/19/2014

Username: Alee.Mousseau

Division: HIGHWAY

Filename: ... \184\_XSECT\_775+39\_151.dgn

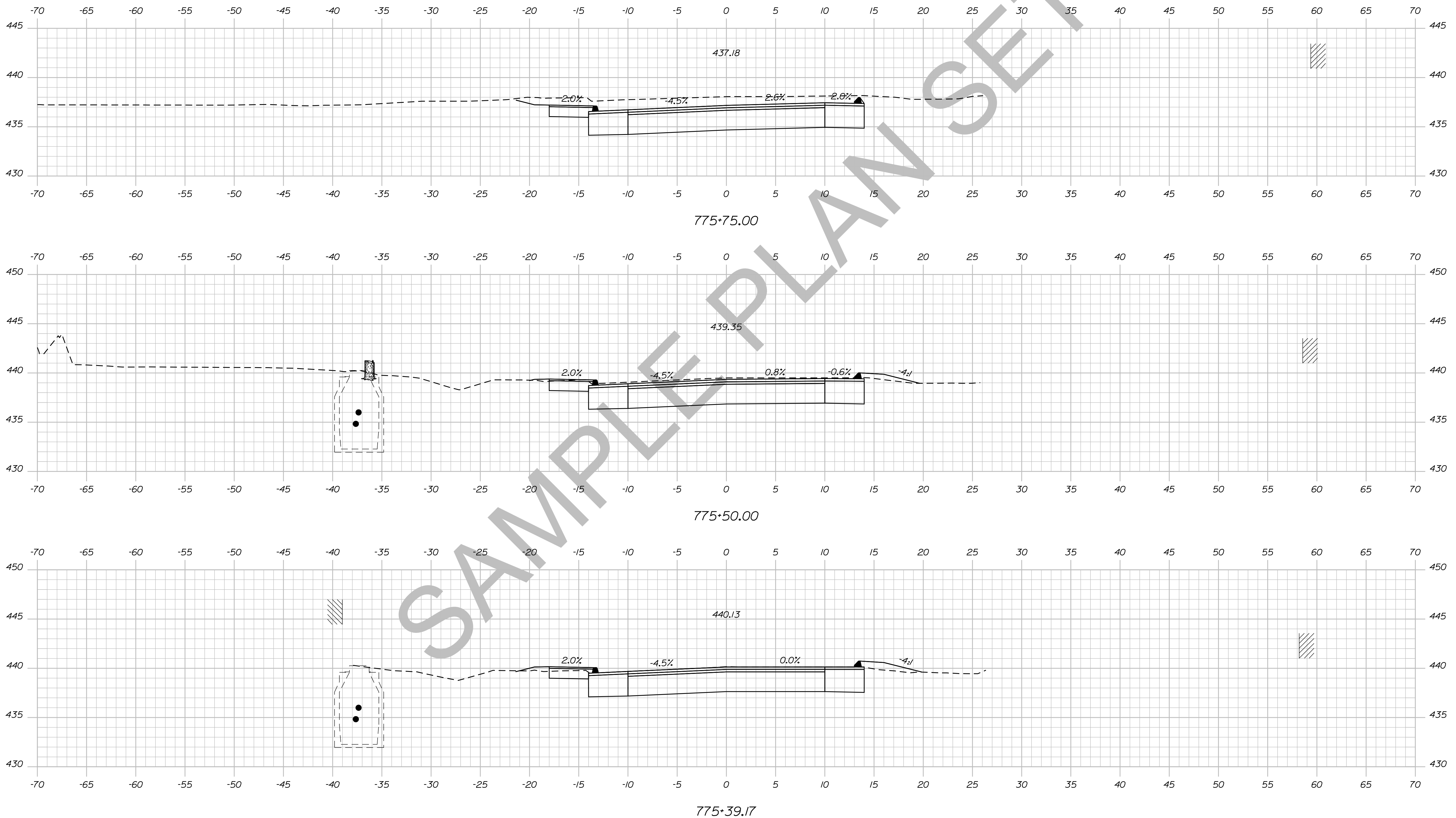

STATE OF MAINE  
DEPARTMENT OF TRANSPORTATION  
018246.00  
PIN  
18246.00  
HIGHWAY PLANS

DATE	BY	PROJ. MANAGER	ERNEST MARTIN
		TRAVIS WHEEL	
		CHECKED-REVIEWED	
		DESIGNED-DETAILED	
		DESIGNED-DETAILED	
		REVISIONS 1	
		REVISIONS 2	
		REVISIONS 3	
		REVISIONS 4	
		FIELD CHANGES	

DEXTER  
ROUTE 7  
CROSS SECTIONS

SHEET NUMBER  
**184**  
OF 15

Date: 5/19/2014

Username: Allee.Mousseau

Division: HIGHWAY

Filename: ... \185\_XSECT\_776-00\_152.dgn

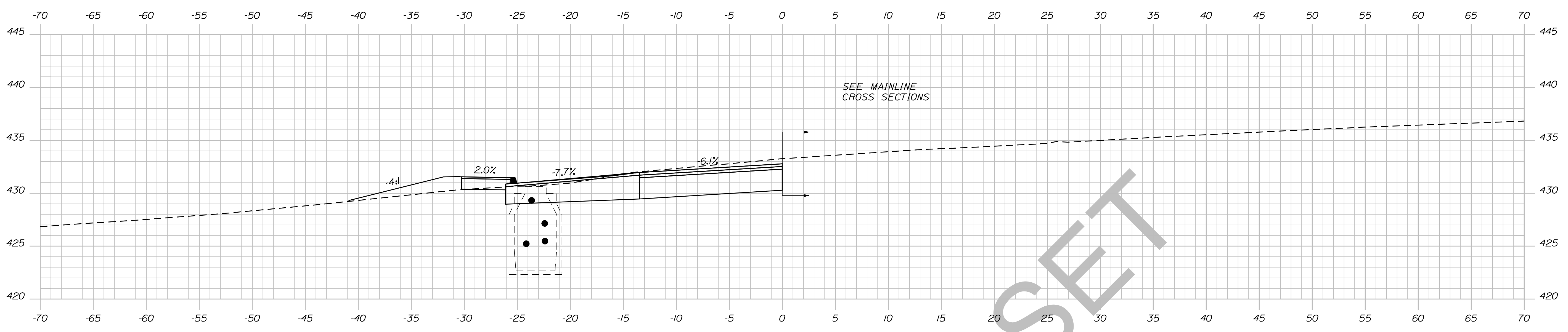

776+32.44

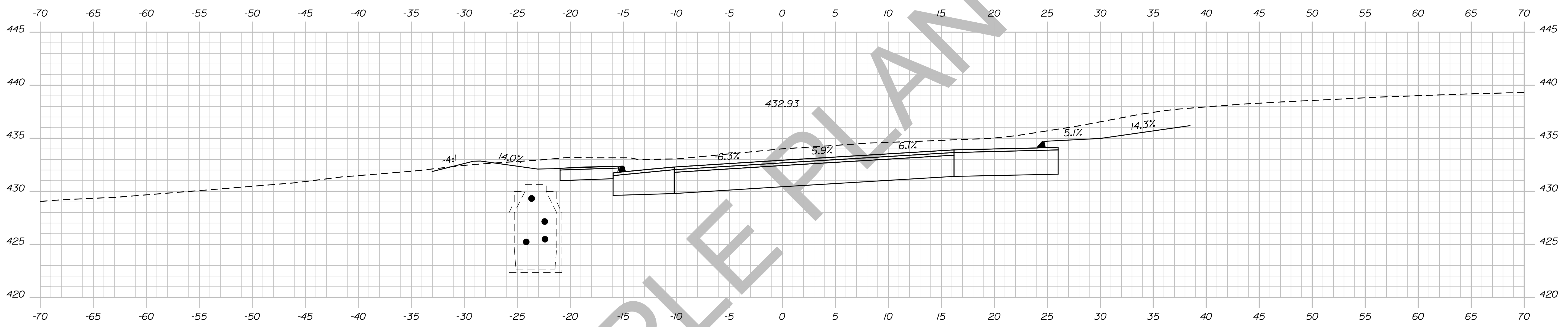

776+25.00

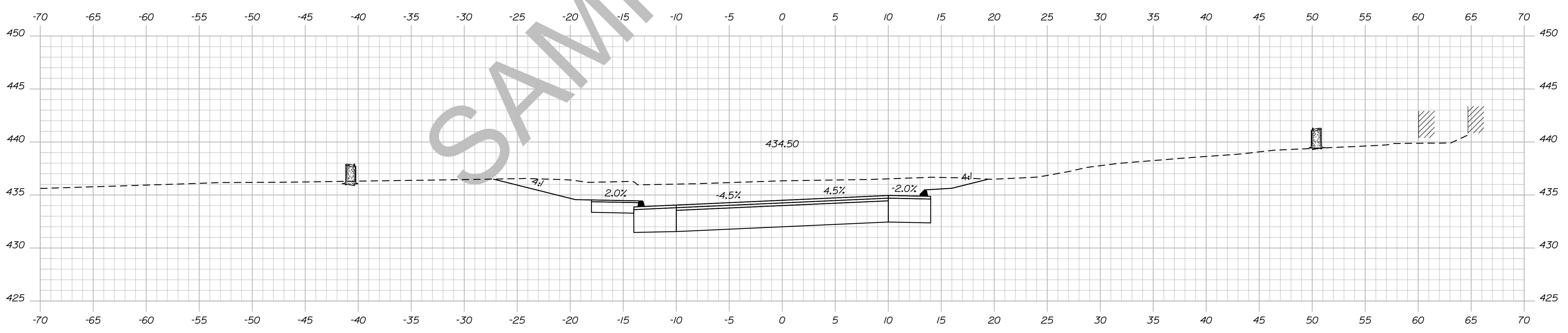

776+00.00

STATE OF MAINE  
DEPARTMENT OF TRANSPORTATION  
018246.00  
PIN  
18246.00  
HIGHWAY PLANS

PROJ. MANAGER	ERNEST MARTIN	BY	DATE
CHECKED-REVIEWED	TRAVIS WHEELER		
DESIGNS DET AILED			
DESIGNS DET AILED			
REVISIONS 1			
REVISIONS 2			
REVISIONS 3			
REVISIONS 4			
FIELD CHANGES			

DEXTER  
ROUTE 7  
CROSS SECTIONS

SHEET NUMBER  
**185**  
OF 15

Date: 5/19/2014

Username: Allee.Mousseau

Division: HIGHWAY

Filename: ... \186\_XSECT\_800+00\_153.dgn

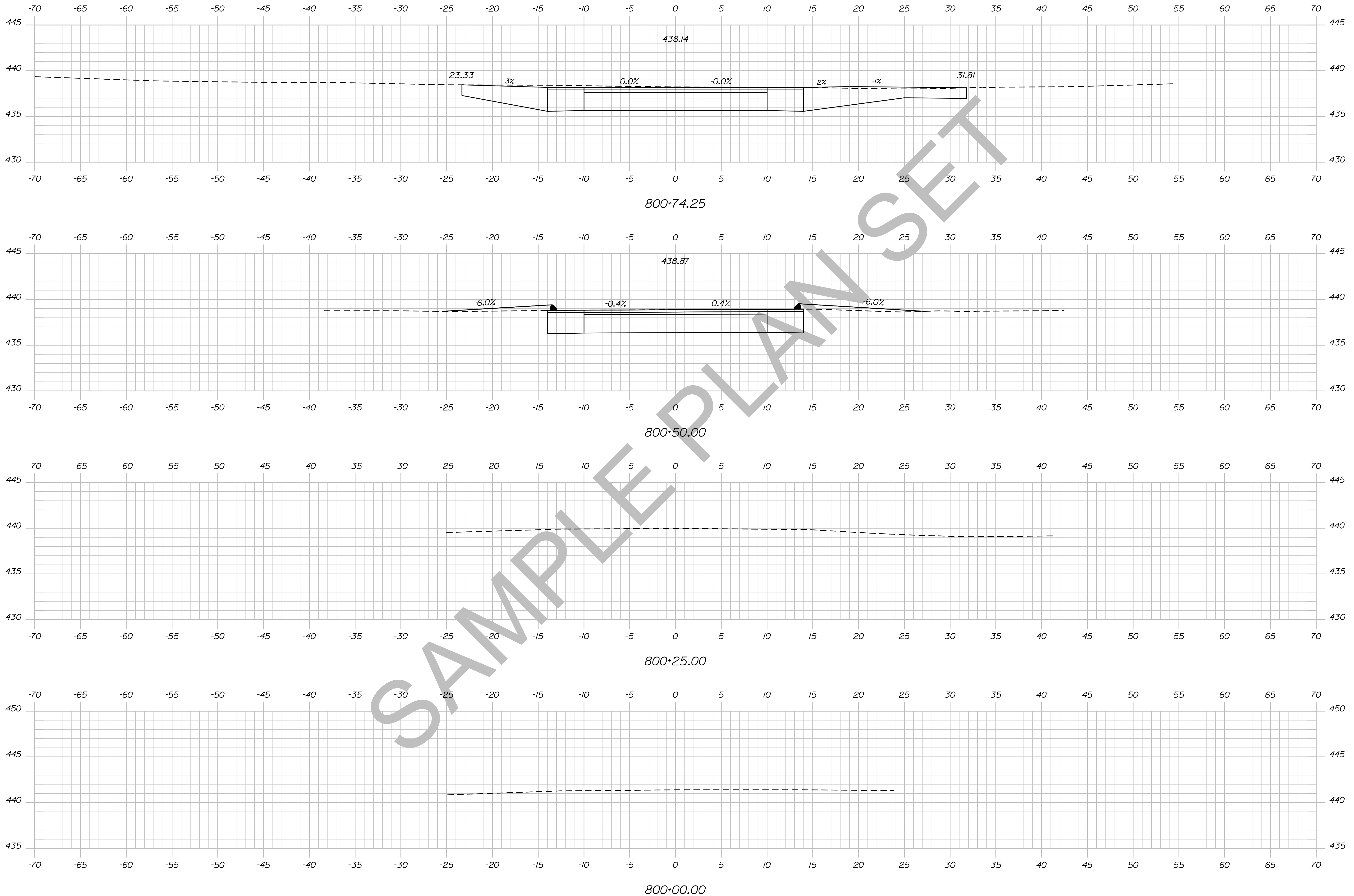

STATE OF MAINE  
DEPARTMENT OF TRANSPORTATION  
018246.00  
PIN  
18246.00  
HIGHWAY PLANS

SIGNATURE  
P.E. NUMBER  
DATE

PROJ. MANAGER	BY	DATE
ERNEST MARTIN	TRAVIS WHEELER	
DESIGN-DETAILED		
CHECKED-REVIEWED		
DESIGN-DETAILED		
DESIGN-DETAILED		
REVISIONS 1		
REVISIONS 2		
REVISIONS 3		
REVISIONS 4		
FIELD CHANGES		

DEXTER  
ROUTE 7  
CROSS SECTIONS

SHEET NUMBER  
**186**  
OF 15

Date: 5/19/2014

Username: Allee.Mousseau

Division: HIGHWAY

Filename: ... \187\_XSECT\_800+75\_154.dgn

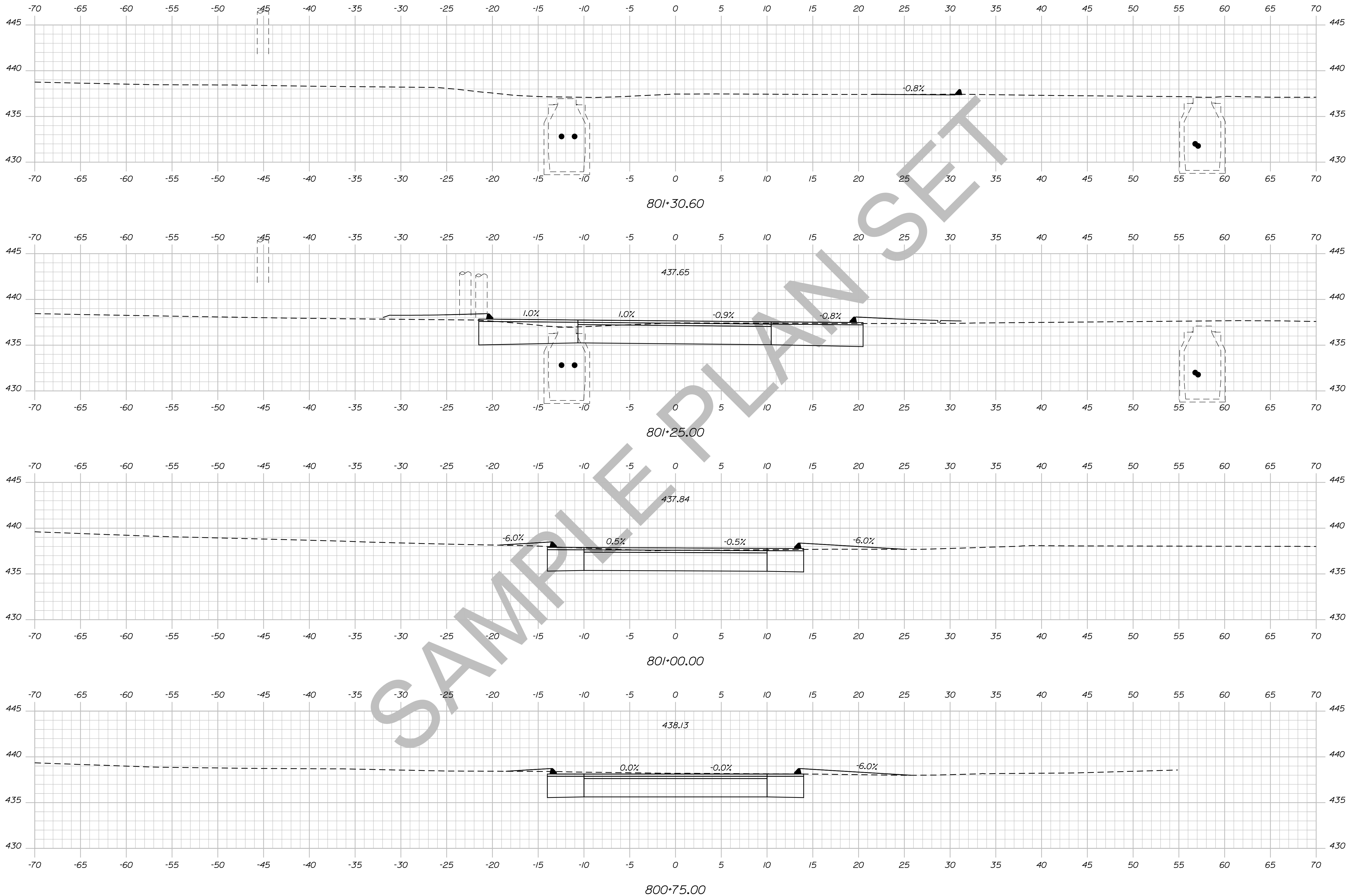

STATE OF MAINE  
DEPARTMENT OF TRANSPORTATION  
018246.00  
PIN  
18246.00  
HIGHWAY PLANS

PROJ. MANAGER	BY	DATE	SIGNATURE	P.E. NUMBER	DATE
ERNEST MARTIN	TRAVIS WHEELER				
DESIGN-DETAILED					
CHECKED-REVIEWED					
DESIGN-DETAILED					
DESIGN-DETAILED					
REVISIONS 1					
REVISIONS 2					
REVISIONS 3					
REVISIONS 4					
FIELD CHANGES					

DEXTER  
ROUTE 7  
CROSS SECTIONS

SHEET NUMBER  
**187**  
OF 15



Date: 5/19/2014

Username: Allee.Mousseau

Division: HIGHWAY

Filename: ... \188\_XSECT\_850+75\_155.dgn

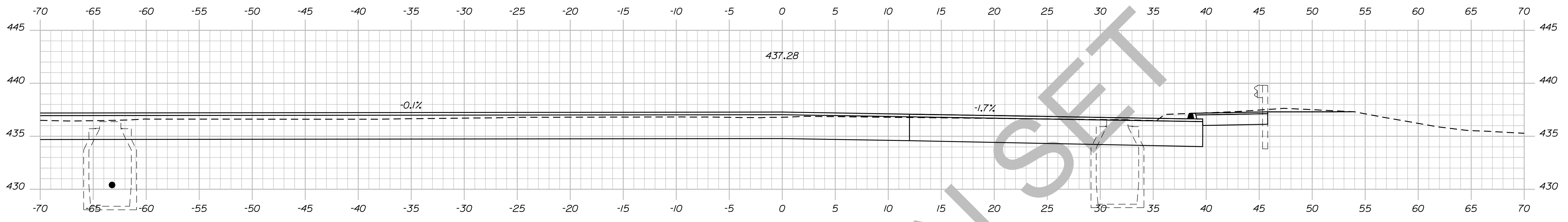

851+25.00

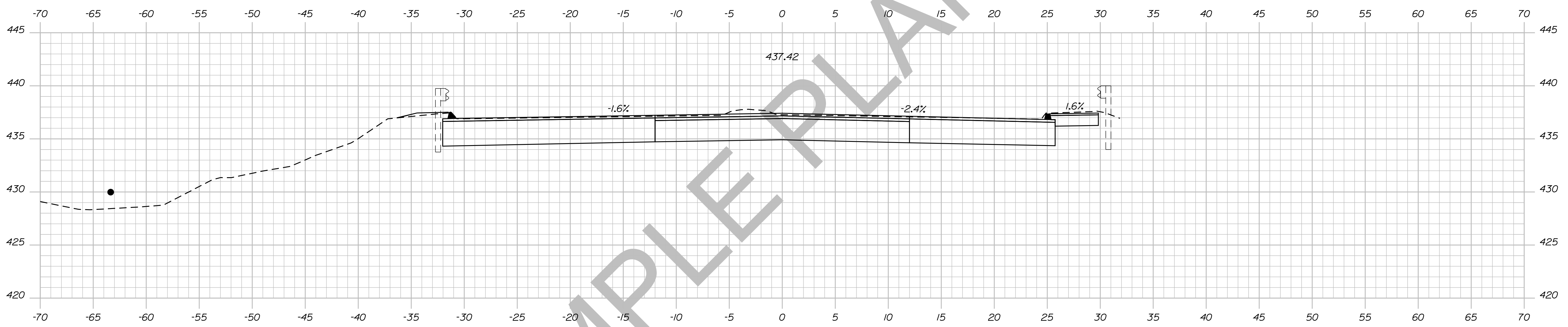

851+00.00

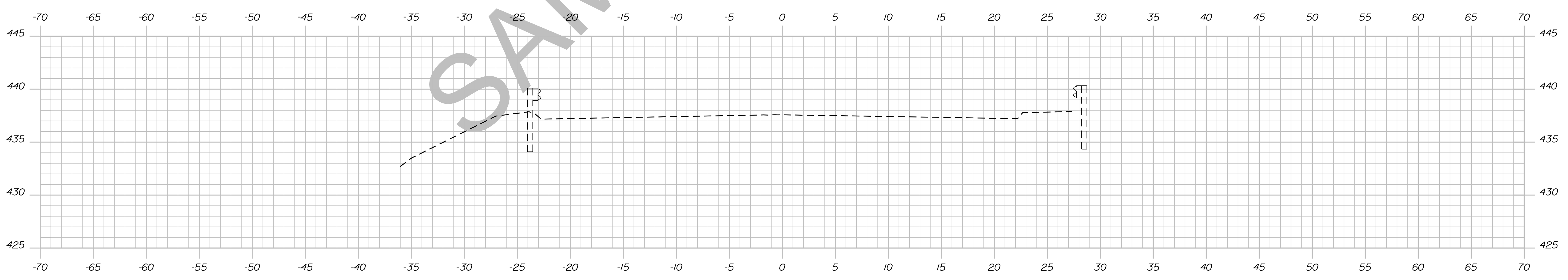

850+75.00

STATE OF MAINE  
DEPARTMENT OF TRANSPORTATION  
018246.00  
PIN  
18246.00  
HIGHWAY PLANS

PROJ. MANAGER	ERNEST MARTIN	BY	DATE
CHECKED-REVIEWED	TRAVIS WOLFE		
DESIGN DETAILED		SIGNATURE	
DESIGNS DET AILED		P.E. NUMBER	
REVISIONS 1		DATE	
REVISIONS 2			
REVISIONS 3			
REVISIONS 4			
FIELD CHANGES			

DEXTER  
ROUTE 7  
CROSS SECTIONS

SHEET NUMBER  
**188**  
OF 15

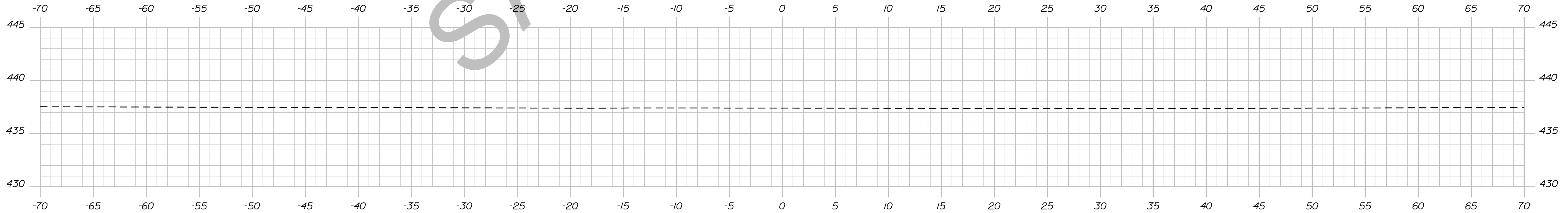

851+50.00

Sta. 851+50.00 to Sta. 851+50.00

STATE OF MAINE  
DEPARTMENT OF TRANSPORTATION

018246.00

PIN  
18246.00

HIGHWAY PLANS

SIGNATURE

DATE

BY

ERNEST MARTIN

TRAVIS WEL

DESIGN-REVIEWED

DESIGN-REVIEWED

DESIGN-REVIEWED

REVISIONS 1

REVISIONS 2

REVISIONS 3

REVISIONS 4

FIELD CHANGES

DATE

P.E. NUMBER

DATE

DATE

DATE

DATE

DATE

DATE

DATE

DATE

DATE

DATE

DEXTER  
ROUTE 7

CROSS SECTIONS

SHEET NUMBER

189

OF 15

Date: 5/19/2014

Username: Alee.Mousseau

Division: HIGHWAY

Filename: ... \190\_XSECT\_900+00\_157.dgn

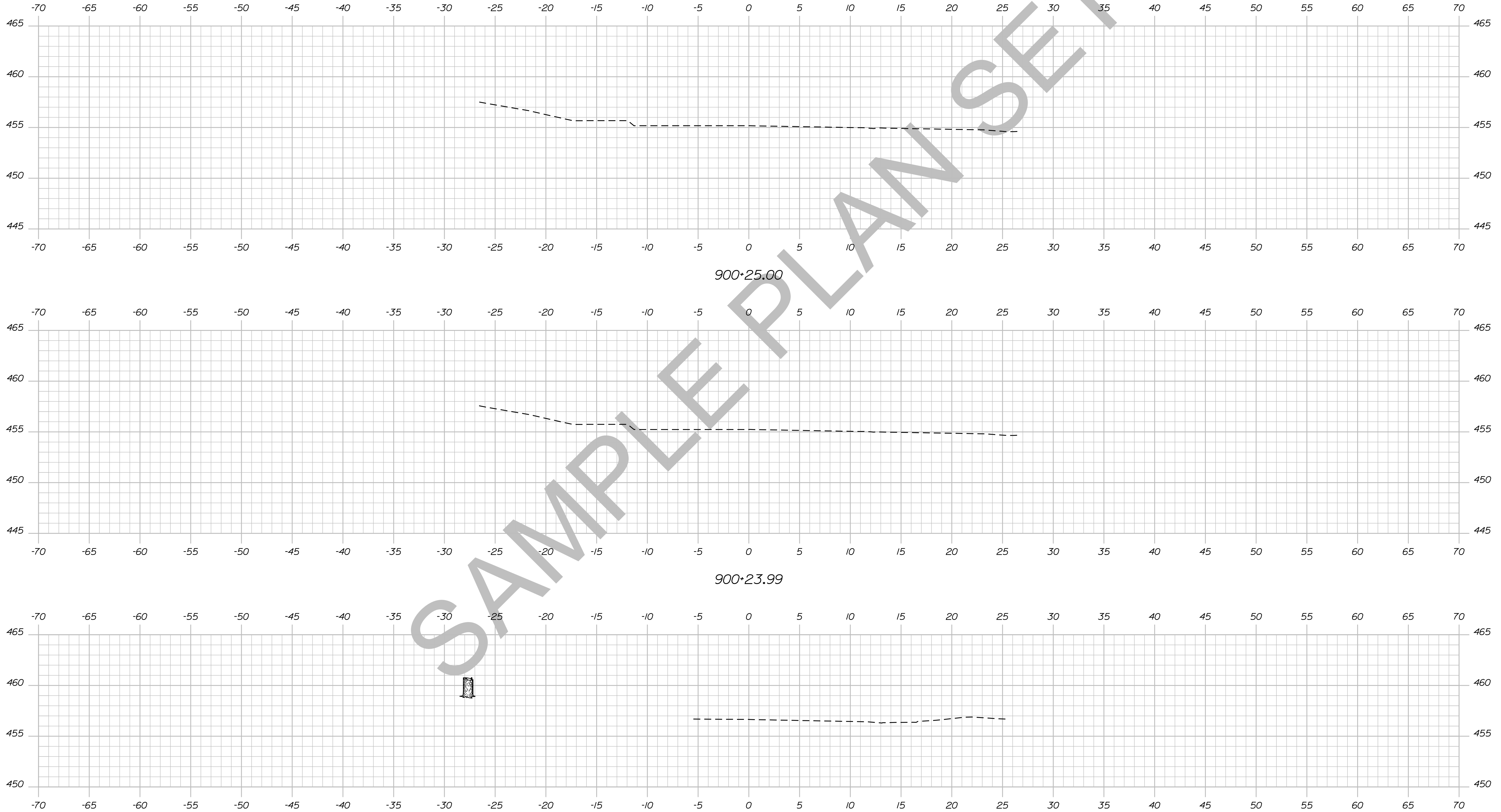

STATE OF MAINE  
DEPARTMENT OF TRANSPORTATION

018246.00

PIN  
18246.00

HIGHWAY PLANS

SIGNATURE

P.E. NUMBER

DATE

DATE

BY

PROJ. MANAGER

ERNEST MARTIN

DESIGN-DETAILED

CHECKED-REVIEWED

DESIGN-DETAILED

DESIGN-DETAILED

REVISIONS 1

REVISIONS 2

REVISIONS 3

REVISIONS 4

FIELD CHANGES

DEXTER  
ROUTE 7

CROSS SECTIONS

SHEET NUMBER

190

OF 15

Date: 5/19/2014

Username: Allee.Mousseau

Division: HIGHWAY

Filename: ... \191\_XSECT\_900+50\_158.dgn

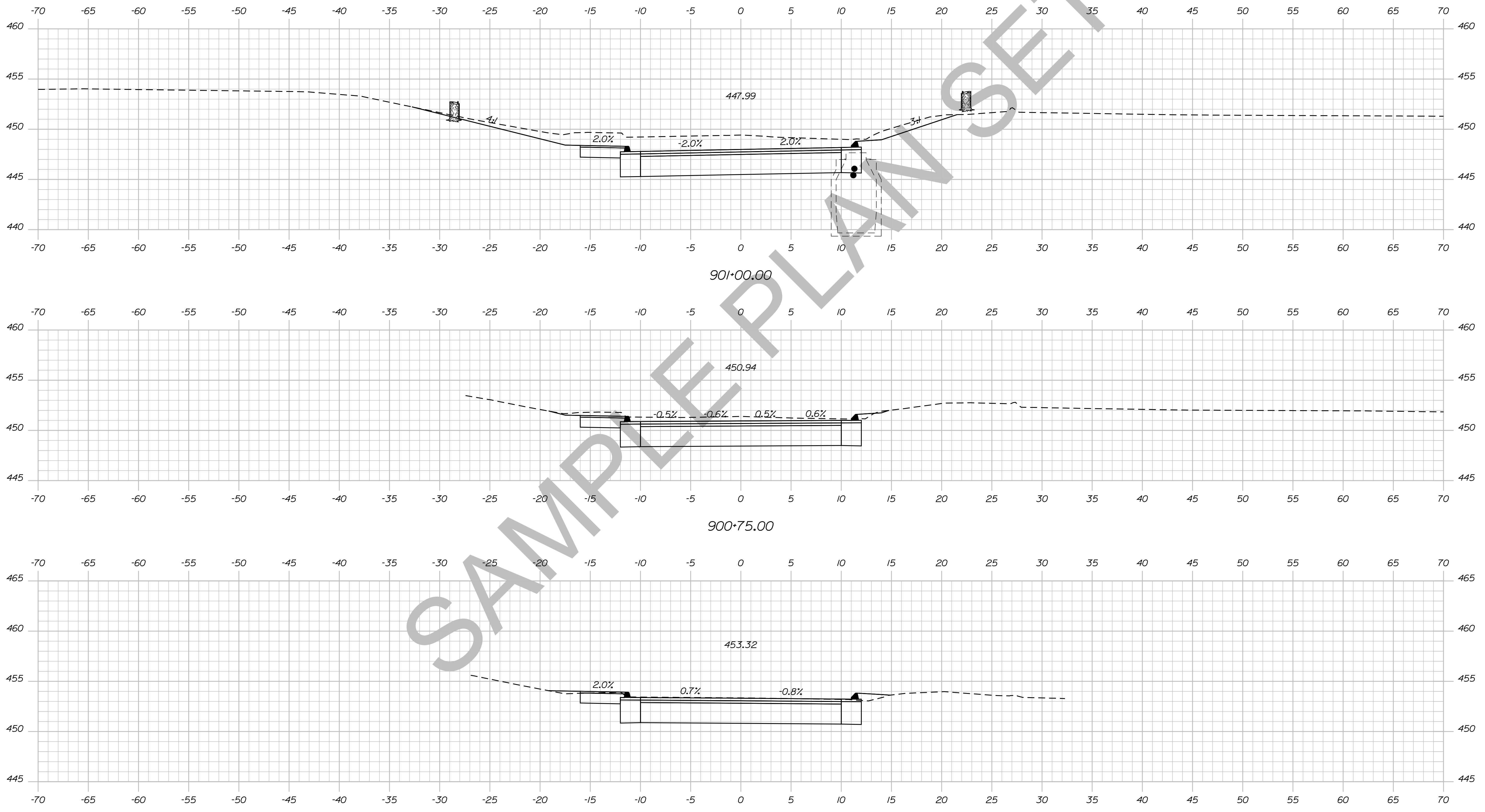

STATE OF MAINE  
DEPARTMENT OF TRANSPORTATION  
018246.00  
PIN  
18246.00  
HIGHWAY PLANS

PROJ. MANAGER	BY	DATE
ERNEST MARTIN	TRAVIS WITTEL	
DESIGN-DETAILED		SIGNATURE
CHECKED-REVIEWED		P.E. NUMBER
DESIGN-DETAILED		DATE
DESIGN-DETAILED		
REVISIONS 1		
REVISIONS 2		
REVISIONS 3		
REVISIONS 4		
FIELD CHANGES		

DEXTER  
ROUTE 7  
CROSS SECTIONS

SHEET NUMBER  
**191**  
OF 15

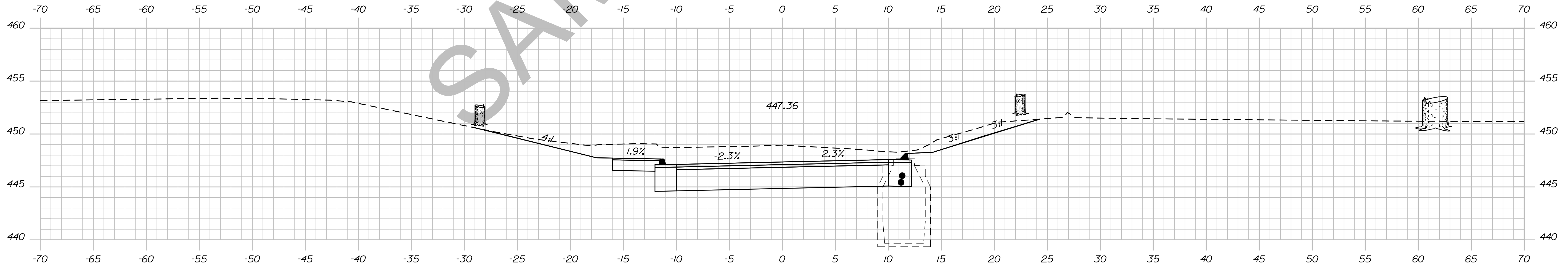

901+06.06

STATE OF MAINE  
 DEPARTMENT OF TRANSPORTATION  
 018246.00  
 PIN 18246.00  
 HIGHWAY PLANS

PROJ. MANAGER	ERNEST MARTIN	BY	DATE
CHECKED-REVIEWED	TRAVIS WOLFE		
DESIGNS DETAILED		SIGNATURE	
REVISIONS 1		P.E. NUMBER	
REVISIONS 2		DATE	
REVISIONS 3			
REVISIONS 4			
FIELD CHANGES			

DEXTER  
 ROUTE 7  
 CROSS SECTIONS

SHEET NUMBER  
 192  
 OF 15